

**5MVP3  
MAIN BOARD  
AT FORM FACTOR  
USER'S MANUAL  
(VER. 1.4)**

---

# 1-1 MOTHERBOARD LAYOUT

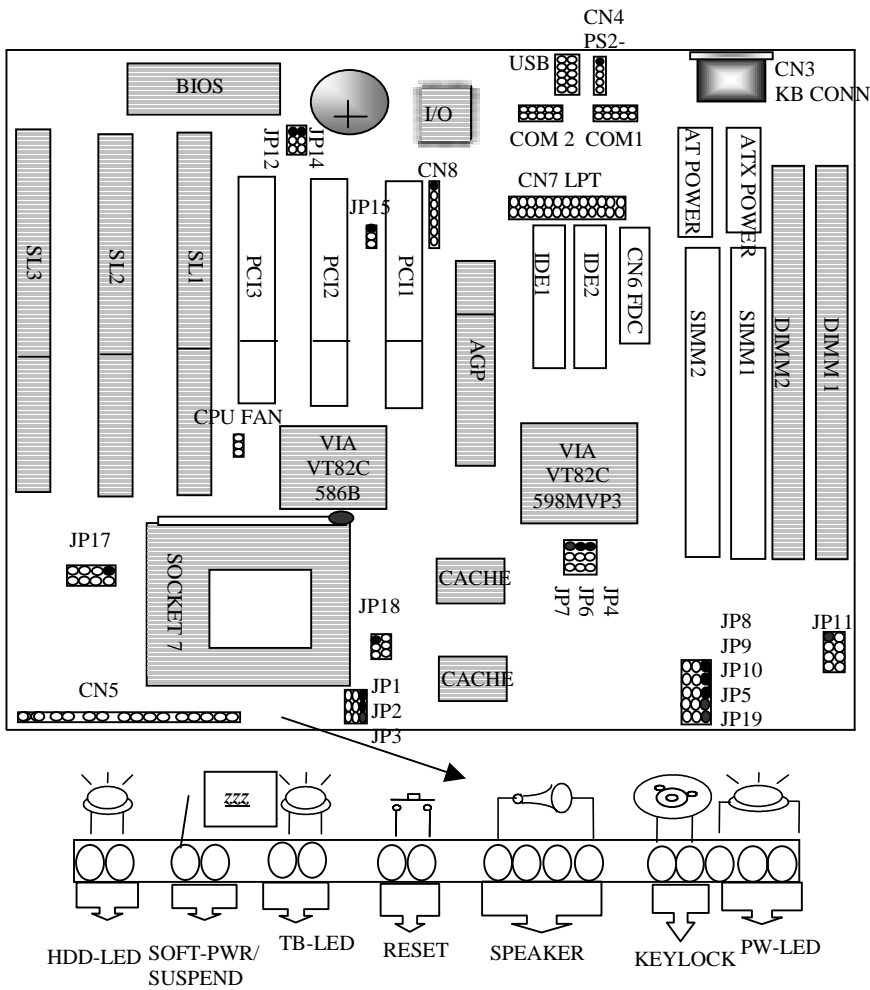

## 1-2 JUMPER SETTINGS

PLEASE MAKE SURE THE JUMPERS ARE CORRECTLY SET.

### INTEL® PENTIUM® PROCESSOR INSTALLATION

CPU CLOCK	SYS. CLOCK	JP17	JP1	JP2	JP3	JP6	JP7	JP8	JP9	JP10	JP18	JP19	RATIO
P54C 90 MHZ 3.3V	60 MHZ	1-2, 5-6, 7-8	1-2	1-2	1-2	2-3	2-3	2-3	1-2	1-2	OPEN	1-2	1.5X
P54C 100 MHZ 3.3V	66 MHZ	1-2, 5-6, 7-8	1-2	1-2	1-2	2-3	2-3	1-2	1-2	1-2	OPEN	1-2	1.5X
P54C 120 MHZ 3.3V	60 MHZ	1-2, 5-6, 7-8	2-3	1-2	1-2	2-3	2-3	2-3	1-2	1-2	OPEN	1-2	2X
P54C 133 MHZ 3.3V	66 MHZ	1-2, 5-6, 7-8	2-3	1-2	1-2	2-3	2-3	1-2	1-2	1-2	OPEN	1-2	2X
P54C 150 MHZ 3.3V	60 MHZ	1-2, 5-6, 7-8	2-3	2-3	1-2	2-3	2-3	2-3	1-2	1-2	OPEN	1-2	2.5X
P54C 166 MHZ 3.3V	66 MHZ	1-2, 5-6, 7-8	2-3	2-3	1-2	2-3	2-3	1-2	1-2	1-2	OPEN	1-2	2.5X
P55C 166 MHZ 2.8/3.3V	66 MHZ	7-8	2-3	2-3	1-2	2-3	2-3	1-2	1-2	1-2	1-2,3-4,5-6	1-2	2.5X
P54C 180 MHZ 3.3V	60 MHZ	1-2, 5-6, 7-8	1-2	2-3	1-2	2-3	2-3	2-3	1-2	1-2	OPEN	1-2	3X
P54C 200 MHZ 3.3V	66 MHZ	1-2, 5-6, 7-8	1-2	2-3	1-2	2-3	2-3	1-2	1-2	1-2	OPEN	1-2	3X
P55C 200 MHZ 2.8/3.3V	66 MHZ	7-8	1-2	2-3	1-2	2-3	2-3	1-2	1-2	1-2	1-2,3-4,5-6	1-2	3X
P55C 233 MHZ 2.8/3.3V	66 MHZ	7-8	1-2	1-2	1-2	2-3	2-3	1-2	1-2	1-2	1-2,3-4,5-6	1-2	3.5X

### CYRIX® 6X86 PROCESSOR INSTALLATION

CPU CLOCK	SYS. CLOCK	JP17	JP1	JP2	JP3	JP6	JP7	JP8	JP9	JP10	JP18	JP19	RATIO
150+ M1 3.52V	60 MHZ	1-2,3-4,5-6,7-8	2-3	1-2	1-2	2-3	2-3	2-3	1-2	1-2	OPEN	1-2	2X
166+ M1 3.52V	66 MHZ	1-2,3-4,5-6,7-8	2-3	1-2	1-2	2-3	2-3	1-2	1-2	1-2	OPEN	1-2	2X
6X86L 150 2.8/3.3V	60 MHZ	7-8	2-3	1-2	1-2	2-3	2-3	2-3	1-2	1-2	1-2,3-4,5-6	1-2	2X
6X86L 166 2.8/3.3V	66 MHZ	7-8	2-3	1-2	1-2	2-3	2-3	1-2	1-2	1-2	1-2,3-4,5-6	1-2	2X
6X86L 200 2.8/3.3V	75 MHZ	7-8	2-3	1-2	1-2	2-3	2-3	1-2	2-3	1-2	1-2,3-4,5-6	1-2	2X
6X86MX 166 2.9/3.3V	66 MHZ	1-2,7-8	2-3	1-2	1-2	2-3	2-3	1-2	1-2	1-2	1-2,3-4,5-6	1-2	2X
6X86MX 166 2.9/3.3V	60 MHZ	1-2, 7-8	2-3	2-3	1-2	2-3	2-3	2-3	1-2	1-2	1-2,3-4,5-6	1-2	2.5X
6X86MX 200 2.9/3.3V	75 MHZ	1-2,7-8	2-3	1-2	1-2	2-3	2-3	1-2	2-3	1-2	1-2,3-4,5-6	1-2	2X
6X86MX 233 2.9/3.3V	75 MHZ	1-2, 7-8	2-3	2-3	1-2	2-3	2-3	1-2	2-3	1-2	1-2,3-4,5-6	1-2	2.5X
*6X86MX 266 2.7/3.3V	83 MHZ	1-2,3-4,5-6	2-3	2-3	1-2	1-2	2-3	2-3	2-3	1-2	1-2,3-4,5-6	1-2	2.5X
*6X86MII 300 2.9/3.3V	66MHZ	1-2, 7-8	1-2	1-2	1-2	2-3	2-3	1-2	1-2	1-2	1-2,3-4,5-6	1-2	3.5X

### AMD® K5/K6/K6-3D PROCESSOR INSTALLATION

CPU CLOCK	SYS. CLOCK	JP17	JP1	JP2	JP3	JP6	JP7	JP8	JP9	JP10	JP18	JP19	RATIO
K5-PR90/PR120 3.52V	60 MHZ	1-2,3-4,5-6,7-8	1-2	1-2	1-2	2-3	2-3	2-3	1-2	1-2	OPEN	1-2	1.5X
K5-PR100/PR133 3.52V	66 MHZ	1-2,3-4,5-6,7-8	1-2	1-2	1-2	2-3	2-3	1-2	1-2	1-2	OPEN	1-2	1.5X
K5-PR166 3.52V	66 MHZ	1-2,3-4,5-6,7-8	2-3	2-3	1-2	2-3	2-3	1-2	1-2	1-2	OPEN	1-2	2.5X
K6-PR166 2.9/3.3V	66 MHZ	1-2,7-8	2-3	2-3	1-2	2-3	2-3	1-2	1-2	1-2	1-2,3-4,5-6	1-2	2.5X
K6-PR200 2.9/3.3V	66 MHZ	1-2,7-8	1-2	2-3	1-2	2-3	2-3	1-2	1-2	1-2	1-2,3-4,5-6	1-2	3X
K6-PR233 3.2/3.3V	66 MHZ	5-6,7-8	1-2	1-2	1-2	2-3	2-3	1-2	1-2	1-2	1-2,3-4,5-6	1-2	3.5X
K6-PR233 3.3/3.3V	66 MHZ	1-2,5-6,7-8	1-2	1-2	1-2	2-3	2-3	1-2	1-2	1-2	1-2,3-4,5-6	1-2	3.5X
K6-PR266 2.2/3.3V	66 MHZ	3-4	2-3	1-2	2-3	2-3	2-3	1-2	1-2	1-2	1-2,3-4,5-6	1-2	4X
K6-PR300 2.2/3.45V	66 MHZ	3-4	2-3	2-3	2-3	2-3	2-3	1-2	1-2	1-2	1-2,3-4,5-6	2-3	4.5X
*K6-3D PR250 2.2V/3.3V	100MHZ	3-4	2-3	2-3	1-2	1-2	2-3	2-3	1-2	2-3	1-2,3-4,5-6	1-2	2.5X
*K6-3D PR300 2.2V/3.3V	100MHZ	3-4	1-2	2-3	1-2	1-2	2-3	2-3	1-2	2-3	1-2,3-4,5-6	1-2	3X

\*K6-3D PR250, K6-3D PR300 AND CYRIX® PR266/MII 300 ARE FOR REFERENCE ONLY, WHICH ARE NOT AVAILABLE WHEN THE MANUAL IS PUBLISHED.

### JP1-JP3 - CPU/BUS RATIO

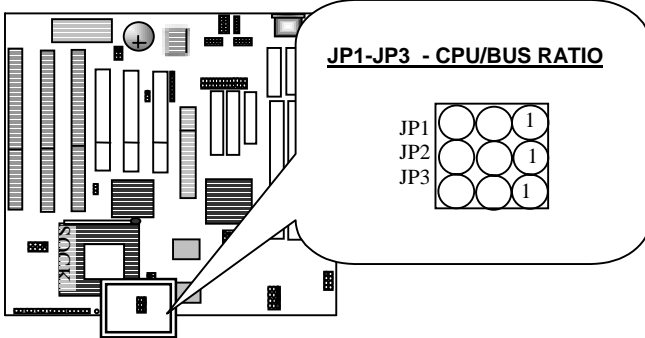

RATIO	JP1	JP2	JP3	RATIO	JP1	JP2	JP3	RATIO	JP1	JP2	JP3
1.5X 	1-2	1-2	1-2	2X 	2-3	1-2	1-2	4.5X 	2-3	2-3	2-3
2.5X 	2-3	2-3	1-2	3X 	1-2	2-3	1-2				
3.5X 	1-2	1-2	1-2	4X 	2-3	1-2	2-3				

### JP4-JP5: SDRAM CLOCK FREQUENCY

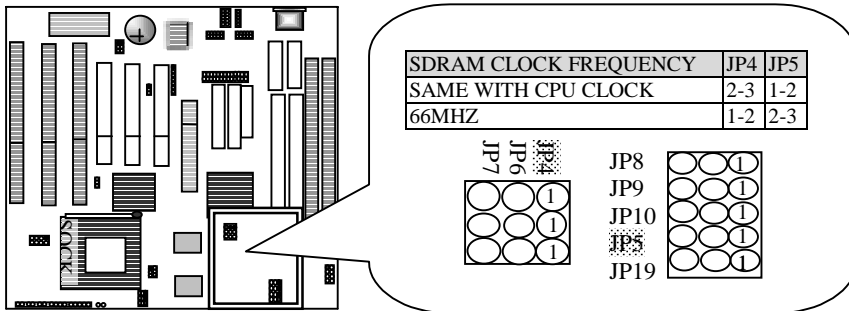

## JP6 - JP10 - CPU SPEED SELECTOR

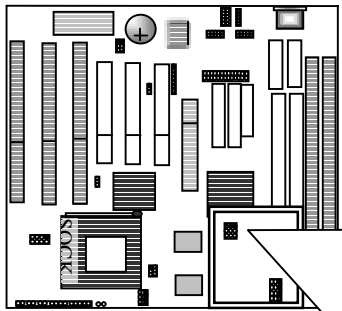

PLEASE NOTE "CPU SPEED SELECTOR" ARE JP6-JP10. JP4 , JP5 & JP19 ARE NOT INCLUDED.

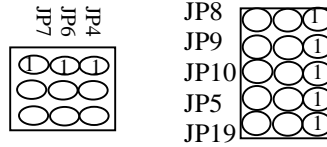

JUMPER	60MHZ	66MHZ	75MHZ	83.3MHZ	100MHZ
JP6	2-3	2-3	2-3	1-2	1-2
JP7	2-3	2-3	2-3	2-3	2-3
JP8	2-3	1-2	1-2	2-3	2-3
JP9	1-2	1-2	2-3	2-3	1-2
JP10	1-2	1-2	1-2	1-2	2-3

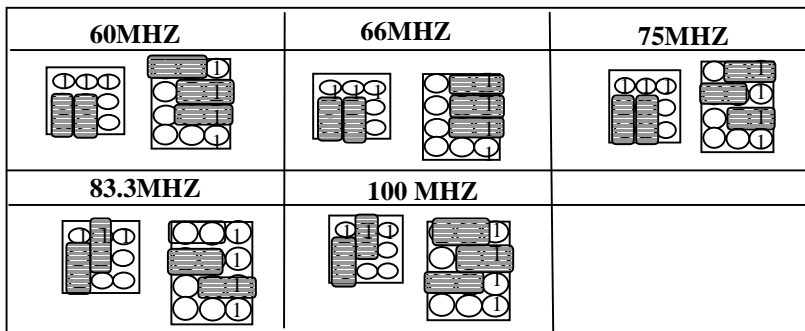

## JP11: DIMM VOLTAGE SELECTOR

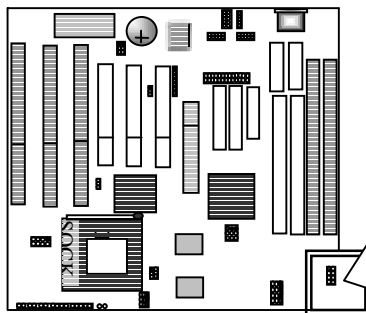

### JP11: DIMM VOLTAGE SELECTOR

JP11	DESCRIPTION
1-2, 3-4	5V DIMM
5-6, 7-8	3.3V DIMM

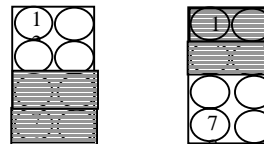

**JP12: FLASH ROM VOLTAGE SELECTOR**

**JP14: CMOS SELECTOR**

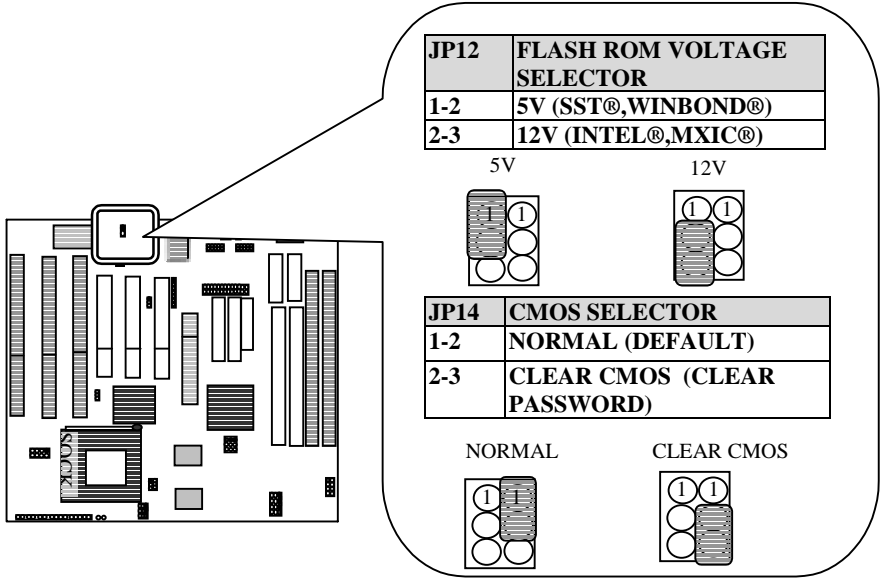

**JP18: CPU VOLTAGE CONNECTOR**

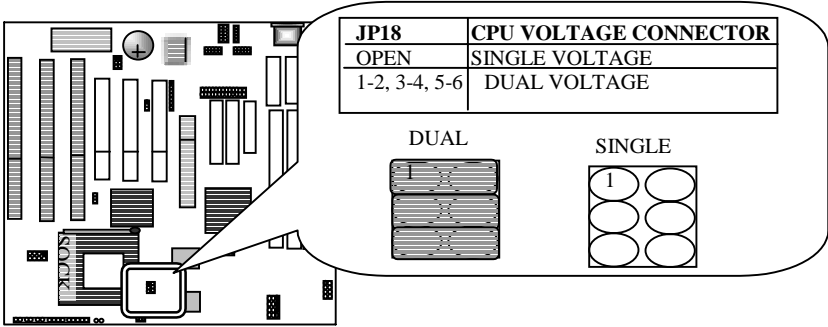

**JP17 - CPU VOLTAGE SELECTOR**

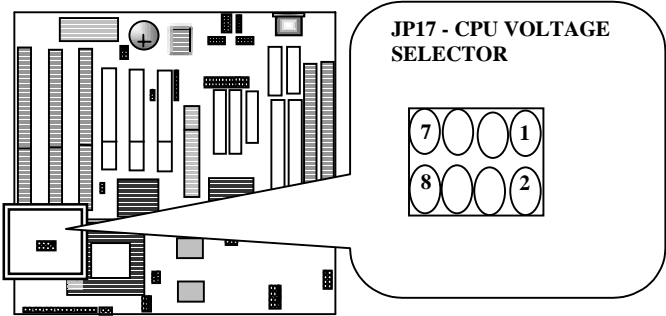

JP17	VCORE	JP17	VCORE
1-2	2.1V 	3-4	2.2V 
1-2, 3-4, 5-6	2.7V 	7-8	2.8V 
1-2, 7-8	2.9V 	5-6, 7-8	3.2V 
1-2, 5-6, 7-8	3.3V 	1-2, 3-4, 5-6, 7-8	3.5V 

## JP19: CPU TYPE SELECTION

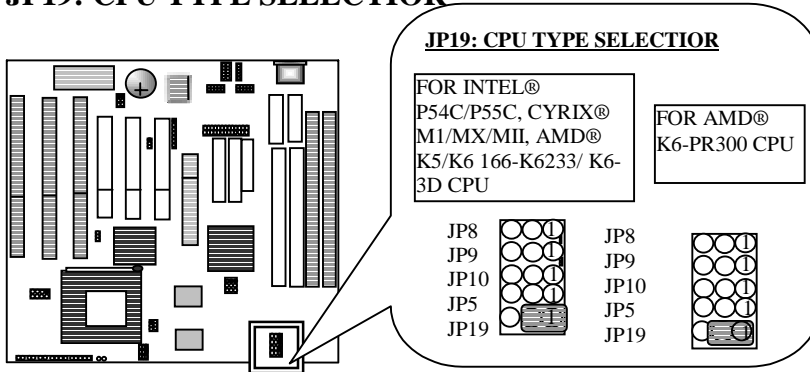

## CN3: KB-CONNECTOR

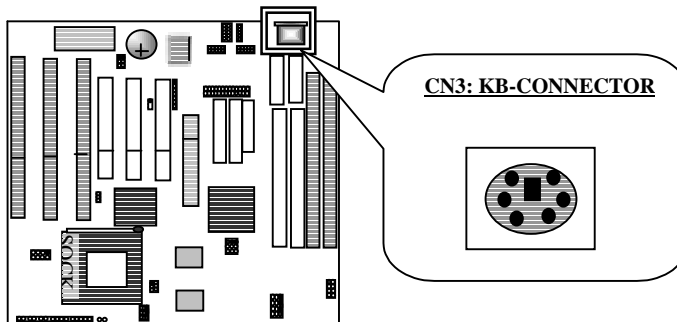

## CN8: I.R (INFRA-RED) CONNECTOR

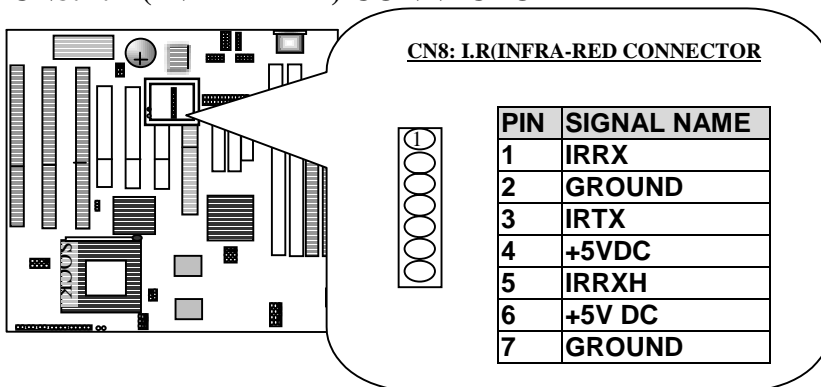



**CN9: AT POWER CONNECTOR**  
**CN10: ATX POWER CONNECTOR**

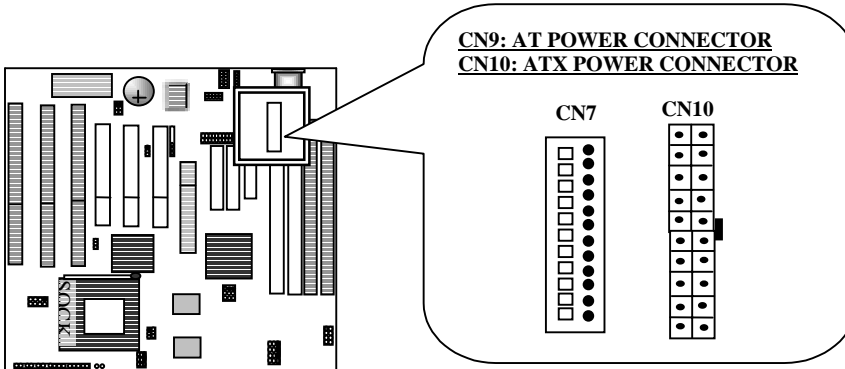

**CN9: AT POWER SUPPLY CONNECTOR**

PIN	DESCRIPTION	PIN	DESCRIPTION
1	POWER GOOD	7	GROUND
2	+5V DC	8	GROUND
3	+12V DC	9	-5V DC
4	-12V DC	10	+5V DC
5	GROUND	11	+5V DC
6	GROUND	12	+5V DC

**CN10- ATX POWER SUPPLY CONNECTOR**

PIN	DESCRIPTION	PIN	DESCRIPTION
1	+3.3V DC	11	+3.3V DC
2	+3.3V DC	12	-12V DC
3	GROUND	13	GROUND
4	+5V DC	14	SOFT-POWER
5	+5V DC	15	GROUND
6	+5V DC	16	GROUND
7	GROUND	17	GROUND
8	POWER GOOD	18	-5V DC
9	+5V STANDBY	19	+5V DC
10	+12V DC	20	+5V DC

**IDE1: PRIMARY HDD CONNECTOR**  
**IDE2: SECONDARY HDD CONNECTOR**  
**CN7: FLOPPY DISK CONNECTOR**

