

TravelMate 730

Service Guide

Service guide files and updates are available on the AIPG/CSD web; for more information, please refer to <http://csd.acer.com.tw>

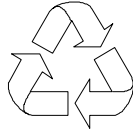

100% Recycled Paper

PART NO.: 49.49C02.001
DOC. NO.: SG324-9911A

PRINTED IN TAIWAN

Copyright

Copyright © 1999 by Acer Incorporated. All rights reserved. No part of this publication may be reproduced, transmitted, transcribed, stored in a retrieval system, or translated into any language or computer language, in any form or by any means, electronic, mechanical, magnetic, optical, chemical, manual or otherwise, without the prior written permission of Acer Incorporated.

Disclaimer

The information in this guide is subject to change without notice.

Acer Incorporated makes no representations or warranties, either expressed or implied, with respect to the contents hereof and specifically disclaims any warranties of merchantability or fitness for any particular purpose. Any Acer Incorporated software described in this manual is sold or licensed "as is". Should the programs prove defective following their purchase, the buyer (and not Acer Incorporated, its distributor, or its dealer) assumes the entire cost of all necessary servicing, repair, and any incidental or consequential damages resulting from any defect in the software.

Acer is a registered trademark of Acer Corporation.

Intel is a registered trademark of Intel Corporation.

Pentium and Pentium II/III are trademarks of Intel Corporation.

Other brand and product names are trademarks and/or registered trademarks of their respective holders.

Conventions

The following conventions are used in this manual:

Screen messages	Denotes actual messages that appear on screen.
NOTE	Gives bits and pieces of additional information related to the current topic.
WARNING	Alerts you to any damage that might result from doing or not doing specific actions.
CAUTION	Gives precautionary measures to avoid possible hardware or software problems.
IMPORTANT	Reminds you to do specific actions relevant to the accomplishment of procedures.

Preface

Before using this information and the product it supports, please read the following general information.

1. This Service Guide provides you with all technical information relating to the BASIC CONFIGURATION decided for Acer's "global" product offering. To better fit local market requirements and enhance product competitiveness, your regional office MAY have decided to extend the functionality of a machine (e.g. add-on card, modem, or extra memory capability). These LOCALIZED FEATURES will NOT be covered in this generic service guide. In such cases, please contact your regional offices or the responsible personnel/channel to provide you with further technical details.
2. Please note WHEN ORDERING FRU PARTS, that you should check the most up-to-date information available on your regional web or channel. If, for whatever reason, a part number change is made, it will not be noted in the printed Service Guide. For ACER-AUTHORIZED SERVICE PROVIDERS, your Acer office may have a DIFFERENT part number code to those given in the FRU list of this printed Service Guide. You MUST use the list provided by your regional Acer office to order FRU parts for repair and service of customer machines.

Chapter 1	System Specifications	1
	Features	1
	System Block Diagram	3
	Board Layout	4
	Top View	4
	Bottom View	5
	Panel	6
	Left Panel	6
	Rear Panel	7
	Bottom Panel	8
	Right Panel	9
	Indicators	10
	Hot Keys	11
	Hardware Specifications and Configurations	12
Chapter 2	System Utilities	23
	BIOS Setup Utility	23
	Navigating the BIOS Utility	23
	System Information	24
	Basic System Settings	25
	Startup Configuration	26
	Onboard Device Configuration	27
	System Security	28
	Load Default Settings	30
	Flash Utility	31
	Executing Flash Program	31
	System Utility Diskette	32
	Panel ID Utility	32
	Thermal and Fan Utility	32
	Main Board Data Utility	32
	System Diagnostic Diskette	33
	Running PQA Diagnostics Program	34
Chapter 3	Machine Disassembly and Replacement	37
	General Information	38
	Before You Begin	38
	Disassembly Procedure Flowchart	39
	Removing the Battery Pack	41
	Removing the External DIMM Module	42
	Removing the External Modem Combo Card	43
	Removing the CD-ROM/DVD-ROM Module	44
	Removing the Hard Disk Drive Module	45
	Removing the Floppy Disk Drive Module	46
	Disassembling the Main Unit	47
	Removing the Keyboard	47
	Removing the LCD Module	48
	Removing the TouchPad Module	48
	Removing the CPU	49
	Removing the RTC	50
	Separating the Lower Case from the Upper Case	50
	Removing the Fan	51
	Removing the DC-DC Charger Board	51
	Removing the System Board	52

Table of Contents

Removing the Audio Jack Cover	52
Removing the PCMCIA Socket	52
Removing the Modem Power Cable	52
Disassembling the LCD Module	53
Removing the LCD Bezel.	53
Removing the Speaker Assembly Module	53
Removing the Inverter Board	54
Removing the LCD Bracket	54
Removing the LED Board	55
Removing the Microphone	55
Removing the Left and Right Hinges	56
Chapter 4 Troubleshooting	57
System Check Procedures	58
External Diskette Drive Check	58
External CD-ROM Drive Check	58
Keyboard or Auxiliary Input Device Check.	58
Memory Check	59
Power System Check.	59
Touchpad Check	60
Power-On Self-Test (POST) Error Message	61
Index of Error Messages	62
Index of Symptom-to-FRU Error Message	64
Intermittent Problems.	67
Undetermined Problems	68
Index of AFlash BIOS Error Message	69
Index of PQA Diagnostic Error Code, Message	70
Chapter 5 Jumper and Connector Locations	71
Top View	71
SW4 Settings	72
Bottom View.	73
Chapter 6 FRU (Field Replaceable Unit) List	75
Appendix A Model Definition and Configuration	93
Appendix B Test Compatible Components	95
Windows 95 Environment Test	96
Windows 98 Environment Test	97
Windows 2000 Environment Test	98
Windows NT Environment Test	99
Appendix C Online Support Information	101
Index	103

System Specifications

Features

This computer was designed with the user in mind. Here are just a few of its many features:

Performance

- Intel® Pentium® III Coppermine processor with 256 KB L2 cache
- 64-bit memory bus
- 2X AGP video graphic accelerator with 8 MB video memory
- Large and vibrant Thin Film Transistor (TFT) Extended Graphics Array (XGA) Liquid Crystal Display (LCD)
- Internal removable CD-ROM or DVD-ROM drive (AcerMedia Bay)
- Built-in FDD module
- High-capacity, Enhanced-IDE hard disk
- Li-Ion battery pack
- Power management system with hibernation power saving modes

Multimedia

- 16-bit high-fidelity PCI stereo audio with 3-D sound and wavetable synthesizer
- Built-in dual speakers with microphone
- S-video output
- Ultra-slim, high-speed CD-ROM or DVD-ROM drive
- Dual display capability

Connectivity

- High-speed fax/data modem port
- Fast infrared wireless communication
- USB (Universal Serial Bus) port

Human-centric Design and Ergonomics

- All-in-one design (CD-ROM, FDD, HDD)
- Sleek, smooth and stylish design
- Full-sized keyboard
- Wide and curved palm rest
- Ergonomically-centered touchpad pointing device

Expansion

- CardBus PC card (formerly PCMCIA) slot (type II/I or type III) with ZV (zoomed video) port support¹
- DockMate V mini docking station option for one-step connect/disconnect from peripherals
- Upgradeable memory and hard disk

¹ Only the lower slot supports zoomed video

Display

The large graphics display offers excellent viewing, display quality and desktop performance graphics. The computer supports a Thin-Film Transistor (TFT) liquid crystal display (LCD) displaying 24-bit high-color at 1024x768 Extended Graphic Array (XGA) resolution.

Video performance

2X AGP video graphic accelerator with 8 MB of video memory boost video performance.

Simultaneous display

The computer's large display and multimedia capabilities are great for giving presentations. If you prefer, you can also connect an external monitor when giving presentations. This computer supports simultaneous LCD and CRT display. Simultaneous display allows you to control the presentation from your computer and at the same time face your audience. You can also connect other output display devices such as LCD projection panels for large-audience presentations.

Dual Display

The computer's unique graphics chip takes advantage of Windows 98's multi-display capability, allowing you to extend your desktop to an external display device, such as an external monitor projector. With this feature enabled, you can move program windows to/from the computer LCD and the external monitor.

Power management

The power management system incorporates an "automatic LCD dim" feature that automatically dims the LCD when the computer is powered by a battery pack to conserve battery power. See "Power Management" on page 20 for more information on power management features.

Opening and closing the display

To open the display, slide the display cover latch to the left and lift up the cover. Then tilt it to a comfortable viewing position. The computer employs a microswitch that turns off the display (and enters standby mode) to conserve power when you close the display cover, and turns it back on when you open the display cover.

NOTE: If an external monitor is connected, the computer turns off the display (but does not enter standby mode) when you close the display cover.

To close the display cover, fold it down gently until the display cover latch clicks into place.

WARNING: To avoid damaging the display, do not slam it when you close it. Also, do not place any object on top of the computer when the display is closed.

System Block Diagram

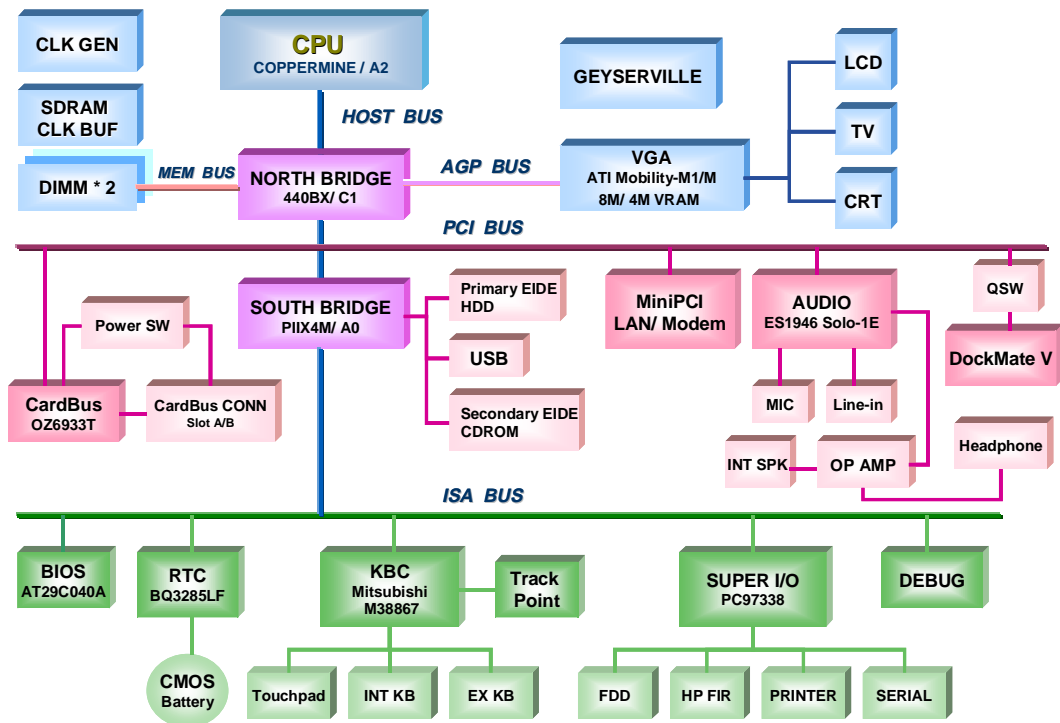

Board Layout

Top View

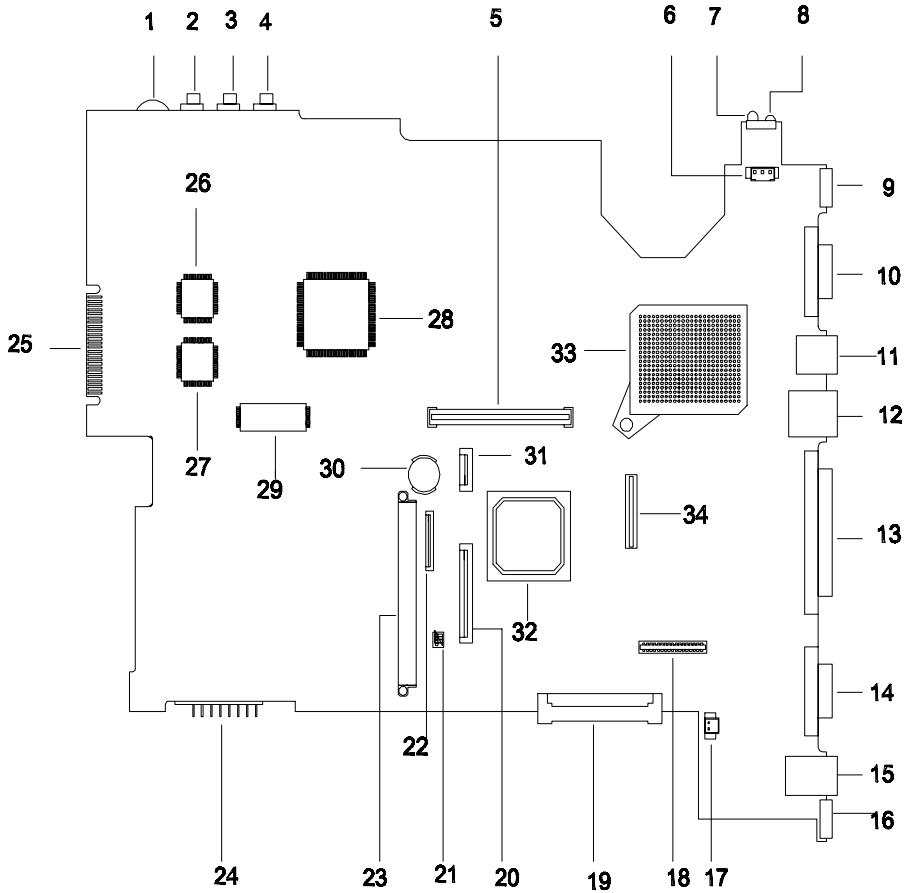

- | | | | |
|----|----------------------------|----|--------------------------------------|
| 1 | Volume Control | 18 | LED/Inverter Board Connector |
| 2 | Microphone-in Port | 19 | External CD/DVD-ROM Module Connector |
| 3 | Line-in Port | 20 | Internal Keyboard Connector |
| 4 | Line-out Port | 21 | Jumper Setting (SW4) |
| 5 | PCMCIA Socket | 22 | Finger Print Check |
| 6 | FAN Connector | 23 | HDD Connector |
| 7 | FIR | 24 | Battery Connector |
| 8 | FIR | 25 | Debug Board Connector |
| 9 | S-Video Port | 26 | Audio Controller |
| 10 | Video Port | 27 | Super I/O Controller |
| 11 | USB Port | 28 | PCI Bus |
| 12 | LAN Connector | 29 | Flash ROM |
| 13 | Parallel Port | 30 | RTC Battery |
| 14 | Serial Port | 31 | TouchPad Connector |
| 15 | Modem Connector | 32 | Video Chip |
| 16 | PS/2 Port | 33 | CPU |
| 17 | LCD Cover Switch Connector | 34 | LCD Connector |

Bottom View

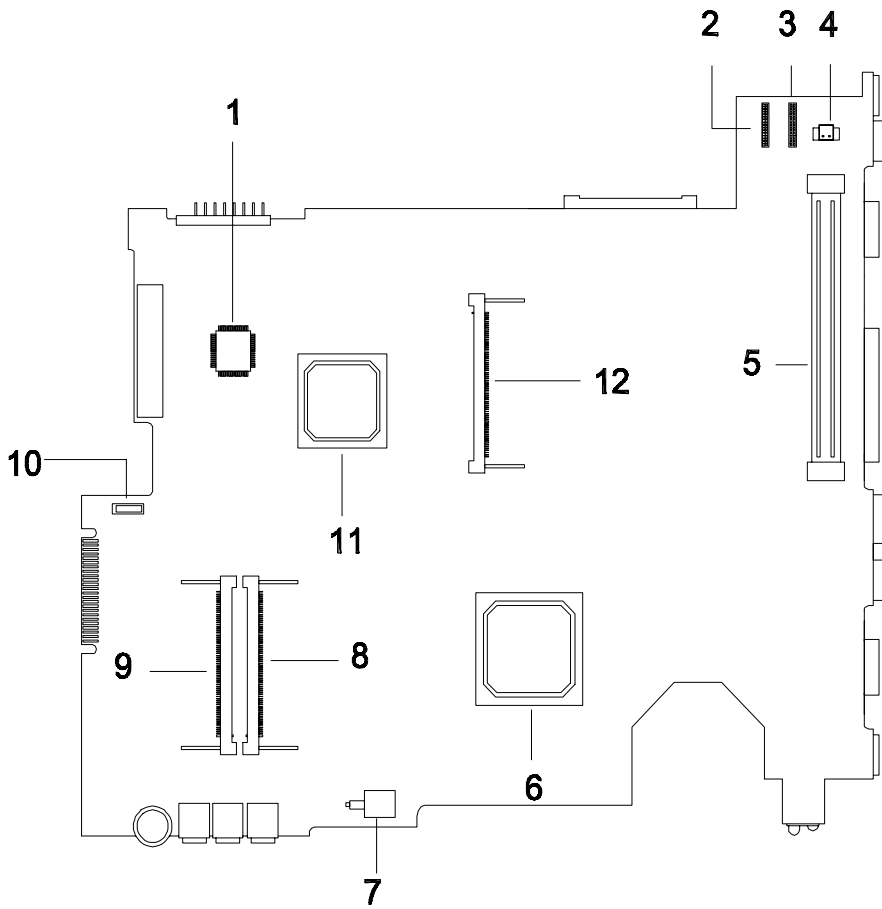





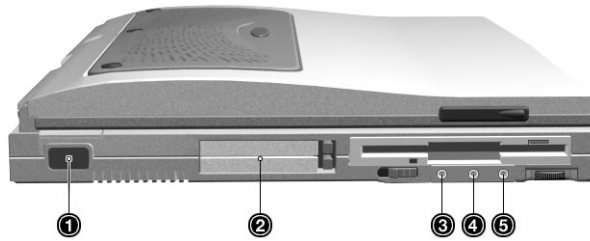

- | | | | |
|---|---------------------------|----|------------------------|
| 1 | Keyboard Controller | 7 | Power Switch Connector |
| 2 | DC-DC Board Connector | 8 | DIMM Socket 1 |
| 3 | DC-DC Board Connector | 9 | DIMM Socket 2 |
| 4 | Modem Connector | 10 | FDD FPC Connector |
| 5 | Docking Station Connector | 11 | South Bridge |
| 6 | North Bridge | 12 | FAX/Modem Board Socket |

Panel

Ports allow you to connect peripheral devices to your computer as you would with a desktop PC.







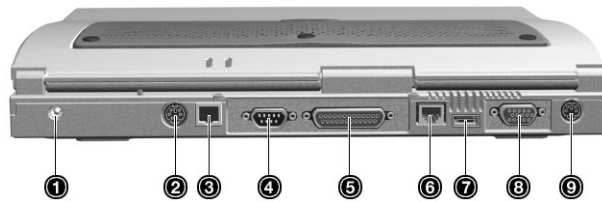

Left Panel



#	Icon	Port	Connects to...
1		Infrared port	Infrared device (e.g., infrared printer, IR-aware computers)
2		PC Card slot	16-bit PC Cards and 32-bit CardBus PC Cards (ZV support)
3		Speaker-out jack	Speakers or headphones
4		Audio line-in jack	Audio line-in device with a 3.5mm mini jack (e.g., audio CD player, stereo walkman)
5		Microphone-in jack	3.5mm mini jack condenser microphone

Rear Panel



#	Icon	Port	Connects to...
1		DC-in jack	AC adapter and power outlet
2		PS/2 port	PS/2-compatible devices (e.g., PS/2 keyboard/mouse/keypad)
3		Modem jack	Phone line (only for models with an internal fax modem)
4		Serial port	Serial devices (e.g., serial mouse)
5		Parallel port	Parallel devices (e.g., parallel printer)
6		Network jack	Ethernet-based network
7		USB port	USB devices (e.g., USB mouse)
8		External monitor port	Display monitor (up to 1024x768 resolution, 64K-colors)
9		S-video output jack	Television with S-video input jack

Bottom Panel

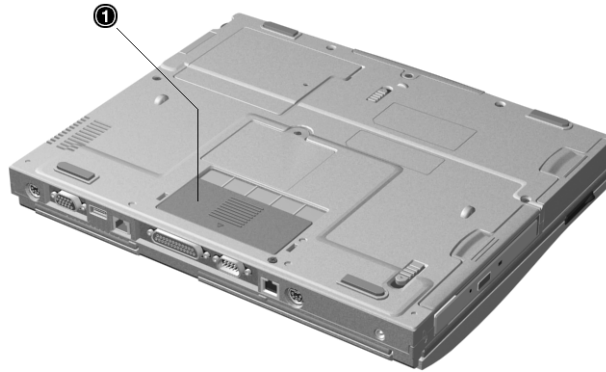

#	Icon	Port	Connects to...
1		Mini docking connector	DockMate V mini docking station

Right Panel

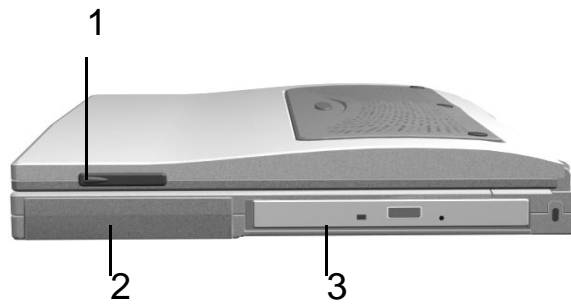







#	Icon	Port	Connects to...
1	N/A	Notebook Camera	N/A
2	N/A	Battery	CN28
3	N/A	DVD/CD-ROM drive	CN15

Indicators

The computer has six easy-to-read status icons on the right of the display screen.



The Power and Standby status icons are visible even when you close the display cover so you can see the status of the computer while the cover is closed.

#	Icon	Function	Description
1		Power	Lights when the computer is on. Blinks when a battery-low condition occurs.
2		Sleep	Lights when the computer enters Sleep mode.
3		Media Activity	Lights when the floppy drive, hard disk or CD-ROM drive is active.
4		Battery Charge	Lights when the battery is being charged.
5		Caps Lock	Lights when Caps Lock is activated.
6		Num Lock (Fn-F11)	Lights when Numeric Lock is activated.

Hot Keys

The computer employs hot keys or key combinations to access most of the computer's controls like screen contrast and brightness, volume output and the BIOS Utility.

To activate hot keys, press and hold the **Fn** key before pressing the other key in the hot key combination.



Hot Key	Icon	Function	Description
Fn-F1	?	Hotkey help	Displays a list of the hotkeys and their functions.
Fn-F2		Setup	Accesses the notebook configuration utility.
Fn-F3		Power Scheme Toggle	Switches between the different Power Management schemes.
Fn-F4	Z ^Z	Sleep	Puts the computer in Sleep mode, which can be defined via the advanced section of the Power Management Properties in the Windows Control Panel.
Fn-F5		Display toggle	Switches display output between the display screen, external monitor (if connected) and both the display screen and external monitor.
Fn-F6		Screen blank	Turns the display screen backlight off to save power. Press any key to return.
Fn-F7		Touchpad on/off	Turns the internal touchpad on and off. When you connect an external PS/2 mouse, the computer automatically disables the touchpad.
Fn-F8		Speaker on/off	Turns the speakers on and off; mutes the sound.
Fn-↑		Contrast up	Increases the screen contrast (available only for models with HPA displays).
Fn-↓		Contrast down	Decreases the screen contrast (available only for models with HPA displays).
Fn-→		Brightness up	Increases the screen brightness.
Fn-←		Brightness down	Decreases the screen brightness.

Hardware Specifications and Configurations

System Board Major Chips

Item	Controller
System core logic	Intel 440BX / PIIX4M
Super I/O controller	NS PC97338VJG
Audio controller	ESS Solo-1E (ES1946)
Video controller	ATI Rage Mobility - M1 BGA
Hard disk drive controller	PIIX4M
Keyboard controller	M38867
RTC	BQ3285LF

Processor

Item	Specification
CPU type	Intel Pentium III 450/500/550/600/650/700/750 MHz processor with 256KB L2 on-die Cache
CPU package	MBGA2 package
CPU core voltage	1.60V/1.35V
CPU I/O voltage	1.50V

BIOS

Item	Specification
BIOS vendor	Acer
BIOS Version	V 3.0
BIOS ROM type	Flash ROM
BIOS ROM size	512KB
BIOS package	32-pin TSOP
Supported protocols	ACPI 1.0a, APM 1.2, PC Card 95, SM BIOS 2.1, EPP/IEEE 1284, ECP/IEEE 1284 1.7 & 1.9, IrDA, PCI 2.1, PnP 1.0a, PS/2 keyboard and mouse, USB, VESA VGA BIOS, DDC-2B, CD-ROM bootable, Windows keyboard Microsoft Simple Boot Flag
BIOS password control	Set by switch, see SW4(SW4) setting

Second Level Cache

Item	Specification
Cache controller	Built-in CPU
Cache size	256KB
1st level cache control	Always enabled
2st level cache control	Always enabled
Cache scheme control	Fixed in write-back

System Memory

Item	Specification
Memory controller	Built-in Intel 440BX
Onboard memory size	0MB
DIMM socket number	2 sockets (2 banks)
Supports memory size per socket	32/64/128 MB
Supports maximum memory size	256MB (128MB x 2)

System Memory

Item	Specification
Supports DIMM type	Synchronous DRAM
Supports DIMM Speed	100MHz
Supports DIMM voltage	3.3V
Supports DIMM package	144-pin DIMM
Memory module combinations	You can install memory modules in any combinations as long as they match the above specifications.

Memory Combinations

Slot 1	Slot 2	Total Memory
32 MB	32 MB	64 MB
0 MB	64 MB	64 MB
64 MB	0 MB	64 MB
32 MB	64 MB	96 MB
64 MB	32 MB	96 MB
0 MB	128 MB	128 MB
64 MB	64 MB	128 MB
128 MB	0 MB	128 MB
32 MB	128 MB	160 MB
128 MB	32 MB	160 MB
64 MB	128 MB	192 MB
128 MB	64 MB	192 MB
128 MB	128 MB	256 MB

Above table lists some system memory configurations. You may combine DIMMs with various capacities to form other combinations.

NOTE: The shipping specification for DIMM combination is 64MB in slot 1.

LAN/Modem Combo Interface

Item	Specification
Chipset	Ambit T60.082.C.00
Fax modem data baud rate (bps)	14.4K
Data modem data baud rate (bps)	56K
Supports modem protocol	V.90 data modem 56K, V.90 fax modem 14.4K and digital line protection operation
Supports LAN protocol	10/100 Mbps
Modem/LAN connector type	RJ11/RJ45
Modem/LAN connector location	Rear side

Modem Interface

Item	Specification
Chipset	Ambit J07.M039.00
Fax modem data baud rate (bps)	14.4K
Data modem data baud rate (bps)	56K
Supports modem protocol	V.90 data modem 56K, V.90 fax modem 14.4K and digital line protection operation
Modem connector type	RJ11

Modem Interface

Item	Specification
Modem connector location	Rear side

Floppy Disk Drive Interface

Item	Specification		
Vendor & model name	Mitsumi D353G		
Floppy Disk Specifications			
Media recognition	2DD (720KB)	2HD (1.2MB, 3-mode)	2HD (1.44MB)
Sectors/track	9	15	18
Tracks	80	80	80
Data transfer rate (Kbit/s)	1 MB	1.6 MB	2 MB
Rotational speed (RPM)	300	360	300
Read/write heads	2		
Encoding method	MFM/FM		
Power Requirement			
Input Voltage (V)	+5V \pm 10%		

Hard Disk Drive Interface

Item	Specification			
Vendor & Model Name	IBM DARA-206000	IBM DARA-209000	IBM DARA-212000	IBM DARA-218000
Capacity (MB)	6000	9000	12000	18000
Bytes per sector	512	512	512	512
Logical heads	15	16	16	16
Logical sectors	63	63	63	63
Drive Format				
Logical cylinders	12416	16383	16383	16383
Physical read/write heads	2	3	4	6
Disks	1	2	2	3
Spindle speed (RPM)	4200	4200	4200	4200
Performance Specifications				
Buffer size	418	418	418	418
Interface	IDE(ATA-4)	IDE(ATA-4)	IDE(ATA-4)	IDE(ATA-4)
Data transfer rate (disk-buffer, Mbytes/s)	85.5-161.6	85.5-161.6	85.5-161.6	85.5-161.6
Data transfer, rate (host-buffer, Mbytes/s)	16.6 (PIO mode 4) 66.6 (Ultra DMA mode 4)			
DC Power Requirements				
Voltage tolerance	5+-5%	5+-5%	5+-5%	5+-5%

CD-ROM Interface

Item	Specification
Vendor & Model Name	MKE/CD-176 24X
Performance Specification	
Transfer rate (KB/sec)	1550KB/sec ~ 3,600KB/sec (FULL - CAV)

CD-ROM Interface

Item	Specification
Access time (typ.)	200 msec. (typ.)
Memory Buffer	128
Interface	Enhanced IDE compatible
Applicable disc format	CD-DA, CD-ROM, CD-ROM XA (except ADPCM), CD-I, Photo CD (Multisession), Video CD, CD+
Loading mechanism	Soft eject (with emergency eject hole)
Power Requirement	
Input Voltage	5V

DVD-ROM Interface

Item	Specification	
Vendor & model name	Toshiba/SDC2302	
Performance Specification	With CD Diskette	With DVD Diskette
Transfer rate (KB/sec)	Mode 1: 4X-5.7X 600 - 855 KB/s 10.3X-24X 1552 - 3600 KB/s Mode 2: 4X-5.7X 684.4 - 975.3 KB/s 10.3X-24X 1769 - 4104 KB/s	3357 - 8112 KB/s
Average Full Access time (typ.)	160 ms	TBD ms
Data Buffer Capacity	128 KB	128KB
Interface	ATAPI	
Applicable disc format	CD-DA, CD+(E)G, CD-MIDI, CD-TEXT, CD-ROM, CD-ROM XA, CD-I, CD-I Bridge (Photo-CD, Video CD), Multisession CD (Photo-CD, CD-Extra, CD-R, CD-RW), CD-R read, CD-RW (read)	DVD-ROM (DVD-5, DVD-9, DVD-10, DVD-18), DVD-R (read, single border)
Loading mechanism	Soft Eject (with emergency eject hole)	
Power Requirement		
Input Voltage	5V	

Audio Interface

Item	Specification
Audio Controller	ESS ES1946 Solo-1E
Audio onboard or optional	Built-in
Mono or Stereo	Stereo
Resolution	16-bit
Compatibility	SB-Pro, Windows Sound System (WSS), MPU-401, OPL3, OPL3-SA3 Microsoft PC97/PC98/PC99, WHQL audio requirement
Mixed sound source	Voice, Synthesizer, Line-in, Microphone, CD
Voice channel	8/16-bit, mono/stereo
Sampling rate	44.1 KHz
Internal microphone	Yes
Internal speaker / Quantity	Yes / 1 piece
Supports PnP DMA channel	DMA channel 0 DMA channel 1
Supports PnP IRQ	IRQ3, IRQ5, IRQ7, IRQ9, IRQ10, IRQ11

Video Interface

Item	Specification
Chip vendor	ATI
Chip name	Rage Mobility-M1
Chip voltage	Core/2.5V Memory/3.3V
Supports ZV (Zoomed Video) port	Yes
Graph interface	2X AGP (Accelerated Graphics Port) bus
Maximum resolution (LCD)	1024x768 (24 bit colors)
Maximum resolution (CRT)	1024x768 (24 bit colors)

Video Memory

Item	Specification
Fixed or upgradeable	Fixed, built-in video controller
Video memory size	8.0 MB

Video Resolutions Mode

Resolution	Refresh Rate	
	CRT Only	LCD/CRT Simultaneous
640x480x256	85	60
640x480x64K	85	60
640x480x16M	85	60
800x600x256	85	60
800x600x64K	85	60
1024x768x256	60, 75	60

Parallel Port

Item	Specification
Parallel port controller	NS PC97338VJG
Number of parallel port	1
Location	Rear side
Connector type	25-pin D-type connector, in female type
Parallel port function control	Enable/Disable by BIOS Setup
Supports ECP/EPP	Yes (set by BIOS setup)
Optional ECP DMA channel (in BIOS Setup)	DMA channel 1 and 3
Optional parallel port I/O address (in BIOS Setup)	3BCh, 378h, 278h
Optional parallel port IRQ (in BIOS Setup)	IRQ5, IRQ7

Serial Port

Item	Specification
Serial port controller	NS PC97338VJG
Number of serial port	1
Supports 16550 UART	Yes
Connector type	9-pin D-type connector, in male type
Location	Rear side
Serial port function control	Enable/Disable by BIOS Setup
Optional serial port (in BIOS Setup)	3F8h, 3E8h, 2E8h
Optional serial port IRQ (in BIOS Setup)	IRQ4, IRQ11

USB Port

Item	Specification
USB Compliancy Level	1.0
OHCI	USB 1.0
Number of USB port	1
Location	Rear side
Serial port function control	Enable/Disable by BIOS Setup

IrDA Port

Item	Specification
IrDA FIR port controller	NS PC97338VJG
Number of IrDA FIR port	1
Location	Left side
IrDA FIR port function control	Enable/disable by BIOS Setup
Optional IrDA FIR port (in BIOS Setup)	2F8h, 3F8h, 3E8h
Optional IrDA FIR port IRQ (in BIOS Setup)	IRQ3, IRQ10, IRQ11
Optional IrDA FIR port DRQ (in BIOS Setup)	DRQ3, DRQ0

PCMCIA Port

Item	Specification
PCMCIA controller	O2 OZ6833T
Supports card type	Type-III/II/I
Number of slots	One type-III or Two type-II/I
Access location	Left side
Supports ZV (Zoomed Video) port	only slot 1 can support ZV function
Supports 32 bit CardBus	Yes (IRQ9)

Keyboard

Item	Specification
Keyboard controller	Mitsubishi M38867
Keyboard vendor & model name	JME K9811
Total number of keypads	84/85/88-key
Windows 95 keys	Yes

Keyboard

Item	Specification
Internal & external keyboard work simultaneously	Yes

Battery

Item	Specification
Vendor & model name	Sony
Battery Type	Li-ion
Pack capacity	5400 mAh
Cell voltage	V/cell
Number of battery cell	9
Package configuration	3 cells in series, 3 series in parallel
Package voltage	11.1 V

DC-AC LCD Inverter

Item	Specification				
Vendor & model name	Ambit T62.123.C.01 Sumida IV12149				
Input voltage (V)	7.3 (min.)	-	-	-	21 (max.)
Input current (mA)	-	-	-	-	900 (max.)
Output voltage (Vrms, no load)	-	-	565 (typ.)	-	-
Output voltage frequency (kHz)	40 (min.)	-	-	-	65 (max.)
Output Current/ Lamp	Iout(Min)	0.7mA	1.0mA	1.3mA	Vadj=0V
	Iout(Max)	6.3mA	7.0mA	7.7mA	Vadj=3.2V

NOTE: DC-AC inverter is used to generate very high AC voltage, then support to LCD CCFT backlight user, and is also responsible for the control of LCD brightness. Avoid touching the DC-AC inverter area while the system unit is turned on.

NOTE: There is an EEPROM in the inverter, which stores its supported LCD type and ID code. If you replace a new inverter or replace the LCD with a different brand, use Inverter ID utility to update the ID information.

LCD

Item	Specification			
Vendor & model name	ADT L133X2-1	CPT CLA141XB01	IBM ITXG76	Hitachi
Mechanical Specifications				
LCD display area (diagonal, inch)	13.3	14.1	14.1	15
Display technology	TFT	TFT	TFT	TFT
Resolution	XGA (1024x768)	XGA (1024x768)	XGA (1024x768)	XGA (1024x768)
Supports colors	262K	260K	262K	262K
Optical Specification				
Brightness control	keyboard hotkey	keyboard hotkey	keyboard hotkey	keyboard hotkey
Contrast control	No	No	No	No
Electrical Specification				

LCD

Item	Specification			
Supply voltage for LCD display (V)	3.3	3.3	3.3	3.3
Supply voltage for LCD backlight (Vrms)	601	650	670	690

AC Adapter

Item	Specification
Vendor & model name	Delta ADT-60XB D 3P
Input Requirements	
Maximum input current (A, @90Vac, full load)	1.5 A @ 90Vac 0.9 A @ 180Vac
Nominal frequency (Hz)	47 - 63
Frequency variation range (Hz)	47 - 63
Nominal voltages (Vrms)	90 - 270
Inrush current	The maximum inrush current will be less than 50A and 100A when the adapter is connected to 115Vac(60Hz) and 230Vac(50Hz) respectively.
Efficiency	It should provide an efficiency of 83% minimum, when measured at maximum load under 115V(60Hz).
Output Ratings (CV mode)	
DC output voltage	+19.0V~20.0V
Noise + Ripple	300mvp-pmax (20MHz bandwidth)
Load	0 A (min.) 2.4 A (max.)
Output Ratings (CC mode)	
DC output voltage	+12V ~ +19V
Constant output	2.75 ± 0.2 A
Dynamic Output Characteristics	
Turn-on delay time	2 sec. (@115Vac)
Hold up time	4 ms min. (@115 Vac input, full load)
Over Voltage Protection (OVP)	24 V
Short circuit protection	Output can be shorted without damage
Electrostatic discharge (ESD)	15kV (at air discharge) 8kV (at contact discharge)
Dielectric Withstand Voltage	
Primary to secondary	1500 Vac (or 2121 Vdc), 10 mA for 1 second
Leakage current	0.25 mA max. (@ 254 Vac, 60Hz)
Regulatory Requirements	Internal filter meets: 1. FCC class B requirements. (USA) 2. VDE 243/1991 class B requirements. (German) 3. CISPR 22 Class B requirements. (Scandinavia) 4. VCCI class II requirements. (Japan)

Power Management

Power Saving Mode	Phenomenon
<p>Standby Mode</p> <p>Waiting time specified by the System Standby value or the operating system elapses without any system activity.</p> <p>Or</p> <p>When the computer is about to enter Hibernation mode (e.g., during a battery-low condition), but the Hibernation file is invalid or not present.</p>	<input type="checkbox"/> The buzzer beeps <input type="checkbox"/> The Sleep indicator lights up
<p>Hibernation Mode</p> <p>When customized functions for power management are set to Hibernation and the corresponding action is taken.</p>	<input type="checkbox"/> All power shuts off
<p>Display Standby Mode</p> <p>Keyboard, built-in touchpad, and an external PS/2 pointing device are idle for a specified period.</p>	<input type="checkbox"/> The display shuts off
<p>Hard Disk Standby Mode</p> <p>Hard disk is idle within a specified period of time.</p>	<input type="checkbox"/> Hard disk drive is in standby mode. (spindle turned-off)

Environmental Requirements

Item	Specification
Temperature	
Operating	+5~+35 °C
Non-operating	-20~+60 °C
Non-operating	-20~+60 °C (storage package)
Humidity	
Operating	20% to 80% RH, non-condensing
Non-operating	20% to 90% RH, non-condensing (unpacked)
Non-operating	20% to 90% RH, non-condensing (storage package)
Vibration	
Operating (unpacked)	5~25.6Hz: 0.38mm (peak to peak) 25.6~250Hz: 0.5G
Non-operating (unpacked)	5~27.1Hz: 0.6G 27.1Hz~50Hz: 0.41 mm (peak to peak) 50~500Hz: 2.0G
Non-operating (packed)	5~62.6Hz: 0.51mm (peak to peak) 62.6~500Hz: 4G

Mechanical Specification

Item	Specification
Dimensions	320.5(W) x 256/260(D) x 36(H)mm for 14.1" TFT 324.7 (W) x 268.55 (D) x 47.55(H) turtle shell for 15.1" TFT
Weight	6.9 lbs for 14.1" TFT

Mechanical Specification

Item	Specification
I/O Ports	2 type II/I or one type III CardBus socket(s), 1 RJ-11 modem port, 1 RJ-45 LAN port, 1 DC-in jack(AC adapter), 1 FIR port, 1 parallel port, 1 serial port, 1 VGA port, 1 PS/2 keyboard/mouse port, 1 mini docking station connector, 1 USB port, 1 speaker/headphone-out jack, 1 audio line-in jack, 1 microphone-in jack, 1 S-video output jack
Drive Bays	One
Material	Housing: MCS-050 Panel : Plastic
Indicators	Power LED, Sleep LED, Media Activity, Battery Charge, Caps Lock, Num Lock
Switch	Power

Memory Address Map

Memory Address	Size	Function
00000000-0009FFFF	640 KB	Base memory
000A0000-000BFFFF	128 KB	Video memory
000C0000-000C9FFF	40 KB	Video BIOS
000CA000-000CBFFF	8 KB	I/O ROM
000E0000-000FFFFF	128 KB	System BIOS
00100000-top limited	--	Extended (DIMM) memory
04301000-04301FFF	4 KB	PCMCIA controller (slot 1)
04302000-04302FFF	4 KB	PCMCIA controller (slot 2)
04300000-04300FFF	64 KB	USB controller
FFFF0000-FFFFFFFF	64 KB	System board extension for PnP BIOS

I/O Address Map

I/O Address	Function
000-00F	DMA controller-1
020-021	Interrupt controller-1
040-043	Timer 1
060, 064	Keyboard controller 8742 chip select
061	System speaker out
040B	DMA controller-1
061	System speaker
070-071	Real-time clock and NMI mask
080-08F	DMA page register
0A0-0A1	Interrupt controller-2
0C0-0DF	DMA controller-2
0F0-0FF	Numeric data processor
120-13F 180-18F	Power management controller
170-177	2nd EIDE device (CD-ROM) select
1F0-1F7	1st EIDE device (hard drive) select
220-22F	Audio
240-24F	Audio (optional)
278-27F	Parallel port 3
2E8-2EF	COM4

I/O Address Map

I/O Address	Function
2F8-2FF	COM2 or FIR (optional)
378, 37A	Parallel port 2
3BC-3BE	Parallel port 1
3B0-3BB 3C0-3DF	Video Controller
3F0h-3F7	Standard Floppy Disk Controller
3E8-3EF	COM3 or LT Win modem (optional)
3F0-3F7	Floppy disk controller
3F8-3FF	COM1
480-48F, 4D6	DMA controller-1
4D0-4D1 CF8-CFF	PCI configuration register

IRQ Assignment Map

Interrupt Channel	Function
NMI	System errors
IRQ0	System timer
IRQ1	Keyboard
IRQ2	Cascade
IRQ3	R2 Card
IRQ4	COM1
IRQ5	Audio or LPT1 (optional)
IRQ6	Floppy
IRQ7	LPT1 or Audio (optional)
IRQ8	Real time clock
IRQ9	Card bus / ACPI / Modem
IRQ10	USB
IRQ11	FIR
IRQ12	PS2 pointing device
IRQ13	Numeric data processor
IRQ14	1st EIDE device (hard disk)
IRQ15	2nd EIDE device (CD-ROM drive)

DMA Channel Assignment

DMA Channel	Function
DRQ0	Audio or FIR (optional)
DRQ1	ECP or Audio or FIR (optional)
DRQ2	Floppy
DRQ3	ECP or FIR (optional)
DRQ4	Not Used
DRQ5	Not used
DRQ6	Not used
DRQ7	Not used

System Utilities

BIOS Setup Utility

The BIOS Setup Utility is a hardware configuration program built into your computer's BIOS (Basic Input/Output System).

Your computer is already properly configured and optimized, and you do not need to run this utility. However, if you encounter configuration problems, you may need to run Setup. Please also refer to Chapter 4 Troubleshooting when problem arises.

To activate the BIOS Utility, press **F2** during POST (while the TravelMate logo is being displayed).

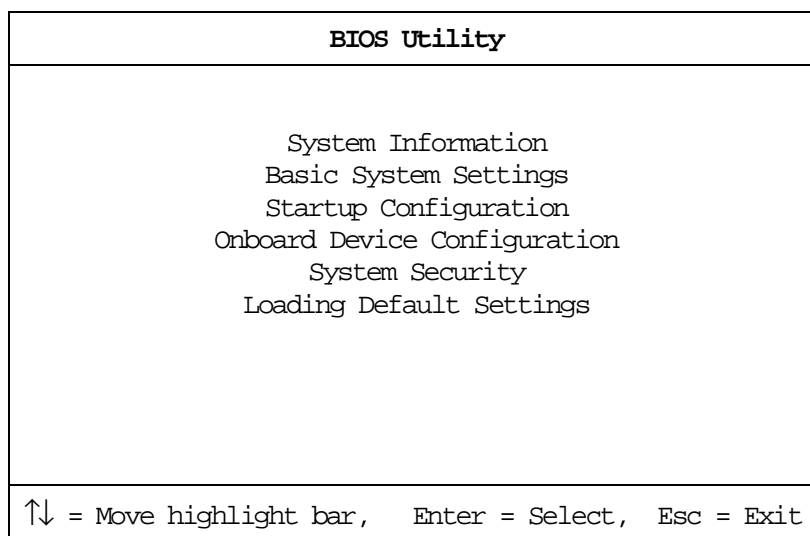

Navigating the BIOS Utility

There are six menu options: System Information, Basic System Settings, Startup Configuration, Onboard Device Configuration, System Security and Load Default Settings.

Use the cursor **up/down** (↑↓) keys to select a menu item, then press **Enter**.

Within a menu, navigate through the BIOS Utility by following these instructions:

- Press the cursor **up/down** (↑↓) keys to move between parameters.
- Press the cursor **left/right** (→←) keys to change the value of a parameter.
- Press **Esc** while you are in any of the menu options to return to the main menu.

NOTE: You can change the value of a parameter if it is enclosed in square brackets.

NOTE: Navigation keys for a particular menu are shown on the bottom of the screen.

At the main menu, press **Esc** to exit the BIOS Utility. If you make any changes, the following dialog box displays:

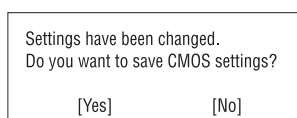

If you would like to keep the changes you made, use the cursor **left/right** (←→) keys to select **Yes**; then press **Enter**. Choose **No** if you want to discard the changes you made.

System Information

The System Information sub-menu displays basic and important information about your computer.

System Information	
CPU Type & Speed	Pentium III, 450 MHz (Coppermine)
Floppy Disk Drive	1.44 MB 3.5-inch
System with	CD-ROM/DVD-ROM Attached
Hard Disk Drive	xxxx MB
HDD Serial Number	xxxxxxxxxxx
System BIOS Version	V3.0 R01-Alh
VGA BIOS Version	ATI MACH64 SDRAM BIOS 4.222T (A730)
Serial Number	xxxxxxxxxxxxxxxxxxxxxxxxxxx
Asset Tag Number	xxxxxxxxxxxxxxxxxxxxxxxxxxx
Product Name	xxxxxxxxxxxxxxxxxxxxxxxxxxx
Manufacturer Name	xxxxxxxxxxxxxxxxxxx
UUID	xxxxxxxx-xxxx-xxxx-xxxx-xxxx
↑↓ = Move highlight bar, ←→ = Change Setting, F1 = Help	

NOTE: The screen above is a sample and may not reflect the actual data on your computer.

The following table describes the information in this sub-menu.

NOTE: “x” may refer to a series of numbers and/or characters or a combination of both.

Parameter	Description	Format
CPU Type & Speed	Shows the type and speed in Megahertz (MHz) of the Central Processing Unit (CPU)	
Floppy Disk Drive	Shows the floppy disk drive type	
System with	Shows the EasyLink Combo Drive type, CD-ROM or DVD-ROM.	
Hard Disk Drive	Shows the size or capacity of the hard disk	
HDD Serial Number	Shows the serial number of the hard disk	
System BIOS Version	Shows the version number of the BIOS.	Vx Rx (version and release numbers)
VGA BIOS Version	Shows the version number of the VGA display BIOS.	Vx Rx (version and release numbers)
Serial Number	Shows the serial number of the system. It is the number identical to the system’s serial number labelled at the bottom of the system unit. The default serial number is scanned while manufacturing, and stored to the LCD inverter.	
Asset Tag Number	Shows the asset tag number of the computer. The default setting is empty. Customers can input it from the Notebook Manager. It will be stored in LCD inverter.	

Parameter	Description	Format
Product Name	Shows the official name of the product "brand name + model name". The default setting is TravelMate 730. Product name will be stored in LCD inverter.	
Manufacturer Name	Shows the name of the manufacturer and stored in LCD inverter. The default setting is Acer.	
UUID	Shows the universally unique identifier number of the computer, also known as GUID (Globally Unique Identifier). It is the requirement specification of SMBIOS 2.1 (System Management BIOS). UUID are fixed-size 128-bit value and are unique across both space and time as well as stored in LCD inverter. UUID number can identify a person and even confidential documents user created.	

The items in this sub-menu are important and vital information about your computer. If you experience computer problems and need to contact technical support, this data helps our service personnel know more about your computer.

Basic System Settings

The Basic System Settings sub-menu allows you to set the system date and time.

Basic System Settings	
Date	[Mon Aug 28, 1998]
Time	[12:00:00]
↑↓ = Move highlight bar, -x- = Change Setting, F1 = Help	

The following table describes the parameters in this sub-menu.

Parameter	Description	Format
Date	Sets the system date.	DDD MMM DD, YYYY (day-of-the-week month day, year)
Time	Sets the system time.	HH:MM:SS (hour:minute:second)

Startup Configuration

The Startup Configuration sub-menu contains parameter values that define how your computer behaves on system startup.

Startup Configuration	
Boot Display	[Auto] / [Both]
Screen Expansion	[Disabled] / [Enabled]
Resume on LAN Access	[Disabled] / [Enabled]
Hotkey Beep	[Enabled] / [Disabled]
Fast Boot	[Enabled] / [Disabled]
Boot Drive Sequence:	
1st	[Hard Disk]
2nd	[Floppy Disk]
3rd	[CD-ROM, DVD-ROM]
↑↓ = Move highlight bar, →← = Change Setting, F1 = Help	

The following table describes the parameters in this sub-menu. Settings in **boldface** are the default and suggested parameter settings.

Parameter	Description	Options
Boot Display	Sets the display on boot-up. When set to Auto , the computer automatically determines the display device when the computer starts up. If an external display device (e.g., monitor) is connected, it becomes the boot display; otherwise, the computer LCD is the boot display. When set to Both , the computer outputs to both the computer LCD and an external display device if one is connected.	Auto or Both
Screen Expansion	Enables or disables the screen expansion feature. When enabled, DOS screens expand to fill the LCD.	Disabled or Enabled
Resume on LAN Access		Disabled or Enabled
Hotkey Beep	Enables or disables a system beep when a hotkey or key combination is pressed.	Enabled or Disabled
Fast Boot	Fast Boot allows your computer to boot up and resume from Sleep mode (including Standby and Hibernation modes) faster. When enabled, the operating system and BIOS communicate information about Plug-and-Play resources and previous boot-ups.	Enabled or Disabled
Boot Drive Sequence	Specifies the order in which the computer starts up from. See the section below.	1st: Hard Disk, 2nd: Floppy Disk, 3rd: CD-ROM, DVD-ROM

Setting the Boot Drive Sequence

The Boot Drive Sequence section lists boot priorities (1st, 2nd and 3rd) for bootable drives in your computer. For example, the default value (1st:Hard Disk, 2nd:Floppy Disk, and 3rd:CD-ROM, DVD-ROM) tells the computer to first search for a hard disk. If it finds one present, it boots up from that hard disk. If not, the computer continues to search for a bootable floppy disk in the floppy drive. If it cannot boot up from the floppy disk drive, it continues to search for a bootable CD-ROM in the CD-ROM drive or a bootable DVD-ROM in the DVD-ROM drive.

To set the boot drive sequence, use the cursor **up/down** (↑↓) keys to select a priority level (1st, 2nd, or 3rd); then use the cursor **left/right** (→←) keys to select the device for that priority level.

Onboard Device Configuration

The parameters in this screen are for advanced users only. You do not need to change the values in this screen because these values are already optimized.

The Onboard Devices Configuration sub-menu assigns resources to basic computer communication hardware.

Onboard Device Configuration	
Serial Port	[Enabled] / [Disabled]
Base Address	[3F8h] / [3E8h] / [2E8h]
IRQ	[4] / [11]
Infrared Port	[Disabled] / [Enabled]
Base Address	[2F8h] / [3F8h] / [3E8h]
IRQ	[3] / [10] / [11]
DMA Channel	[3] / [0]
Parallel Port	[Enabled] / [Disabled]
Base Address	[378h] / [278h] / [3BCh]
IRQ	[7] / [5]
Operation Mode	[ECP] / [EPP] / [Bi-directional] / [Standard]
ECP DMA Channel	[1] *Note 1
↑↓ = Move highlight bar, →← = Change Setting, F1 = Help	

- NOTE:**
1. This option item is set to 1 if user chooses ECP.
 2. This option item should be [---] if user chooses EPP, Bi-directional and Standard mode.
 3. When the device is disabled, all the sub-item will be showed with [---].

The following table describes the parameters in this sub-menu. Settings in **boldface** are the default and suggested parameter settings.

Parameter	Description	Options
Serial Port	Enables or disables the serial port. When enabled, you can set the base I/O address and interrupt request (IRQ) of the serial port.	Enabled or Disabled 3F8h , 3E8h or 2E8h 4 or 11
IrDA Port	Enables or disables the infrared port. When enabled, you can set the base I/O address, interrupt request (IRQ) and direct memory access (DMA) channel of the infrared port.	Disabled or Enabled 2F8h , 3E8h or 3F8h 3 , 10 or 11 3 or 0

Parameter	Description	Options
Parallel Port	Enables or disables the parallel port. When enabled, you can set the base I/O address, interrupt request (IRQ) and operation mode of the parallel port. If operation mode is set to ECP, the direct memory access (DMA) channel of the parallel port is set to 1.	Enabled or Disabled 378h , 278h, or 3BCh 7 or 5 ECP , EPP, Standard, or Bi-directional

System Security

The System Security sub-menu allows you to safeguard your computer and data with passwords and other security measures.

System Security	
Setup Password	[None] / [Present]
Power On Password	[None] / [Present]
Hard Disk Password	[None] / [Present]
Processor Serial Number	[Enabled] / [Disabled]
↑↓ = Move highlight bar, ←→ = Change Setting, F1 = Help	

- NOTE:**
1. In POST, BIOS must query the current HD password state and reflect it to the "Hard Disk Password" setting.
 2. If the user wants to change the password when the HD password is already enabled, the old password must be checked first.

The following table describes the parameters in this screen. Settings in **boldface** are the default and suggested parameter settings.

Parameter	Description	Options
Setup Password	When set, this password protects the computer and this BIOS Utility from unauthorized entry. See the following section for instructions on how to set a password.	None or Present
Power-on Password	When set, this password protects the computer from unauthorized entry. See the following section for instructions on how to set a password.	None or Present
Hard Disk Password	When set, this password protects the hard disk from unauthorized access. See the following section for instructions on how to set a password.	None or Present
Processor Serial Number	The Pentium III processor includes a unique serial number which allows individual CPUs to be identified. You can turn off this feature by setting this parameter to Disabled.	Enabled or Disabled

Setting a Password

Follow these steps:

- Use the cursor up/down keys to highlight a Password parameter (Setup, Power-on or Hard Disk) and press the **Enter** key. The password box appears:
- Type a password. The password may consist of up to seven characters (A-Z, a-z, 0-9).



IMPORTANT: Be very careful when typing your password because the characters do not appear on the screen.

- Press **Enter**. Retype the password to verify your first entry and press **Enter**.

After setting the password, the computer automatically sets the chosen password parameter to Present.

Three password types protect your computer from unauthorized access. Setting these passwords creates several different levels of protection for your computer and data:

- Setup Password prevents unauthorized entry to the BIOS Utility. Once set, you must key-in this password to gain access to the BIOS Utility.
- Power-On Password secures your computer against unauthorized use. Combine the use of this password with password checkpoints on boot-up and resume from hibernation for maximum security.
- Hard Disk Password protects your data by preventing unauthorized access to your hard disk. Even if the hard disk is removed from the computer and moved to another computer, it cannot be accessed without the Hard Disk Password.

When a password is set, a password prompt appears on the left-hand corner of the display screen.

1. When the Setup Password is set, the following prompt appears when you press **F2** to enter the BIOS Utility at boot-up.

Setup Password



Type the Setup Password and press **Enter** to access the BIOS Utility.

2. When the Power-on Password is set, the following prompt appears at boot-up.



Type the Power-on Password (a symbol appears for each character you type) and press **Enter** to use the computer. If you enter the password incorrectly, an **x** symbol appears. Try again and press **Enter**.

3. When the Hard Disk Password is set, the following prompt appears at boot-up.



Type the Hard Disk Password (a symbol appears for each character you type) and press **Enter** to use the computer. If you enter the password incorrectly, an **x** symbol appears. Try again and press **Enter**.

You have three chances to enter a password. If you successfully entered the password, the following symbol appears.



If you fail to enter the password correctly after three tries, the following message or symbol appears.

Setup
Incorrect password specified. System disabled.

Power-on/Hard Disk



Removing a Password

Should you decide to remove a password, do the following:

- Use the cursor **up/down** (\uparrow/\downarrow) keys to highlight a Password parameter (Setup, Power-on or Hard Disk).
- Use the cursor **left/right** (\rightarrow/\leftarrow) key to remove the password.

NOTE: When you want to remove the Hard Disk password, you are prompted for the Hard Disk password before it is removed.

IMPORTANT: The jumper setting Switch 4 of SW4 on the system main board, the default setting is “OFF: Enable Password Check”, this means that the system will always check the password when users set in. However, if users miss their own password, the servicers can switch the jumper to “ON: Disable Password Check” and then the Setup password and Power-on password will be unlocked. Therefore, users can reset their new password. (Refer to Chapter 5 Jumper and Connector for more information on setting the switches).

IMPORTANT: If Setup password is forgot by users, service technicians may need to update computers' BIOS or set up jumper SW4 Switch 4 on mainboard to bypass.

IMPORTANT: If Power-on password is forgot by users, service technicians may set the jumper SW4 to bypass password check, then remove the password.

IMPORTANT: If Hard Disk Password is missing, service technician can solve the lock of hard disk by using master HDD password utility. For the HDD password utility, service technician can contact with local service management level.

Changing a Password

To change a password, follow these steps:

- Remove the current password. See “Removing a Password” on page 30.
- Set a new password. See “Setting a Password” on page 29.

Load Default Settings

If you want to restore all parameter settings to their default values, select this menu item and press **Enter**. The following dialog box displays.

Do you want to load default settings?	
[Yes]	[No]

If you would like to load default settings for all parameters, use the cursor **left/right** (\rightarrow/\leftarrow) keys to select **Yes**; then press **Enter**. Choose **No** if otherwise.

Flash Utility

The BIOS flash memory update is required for the following conditions:

- New versions of system programs
- New features or options

Use the AFlash utility to update the system BIOS flash ROM.

NOTE: Do not install memory-related drivers (XMS, EMS, DPMI) when you use AFlash.

NOTE: This program contains a readme.txt file. This readme.txt file will introduce how to use AFlash utility.

Executing Flash Program

IMPORTANT: If this diskette is not bootable, do the following actions before you use it:

1. Create a bootable disk.
2. Copy all AFlash files into this bootable diskette.
3. Put the bootable disk into TravelMate 730 series mobile, then re-boot.

IMPORTANT: Never turn off the system power while Flash BIOS is programming. This will damage your system.

4. After Flash BIOS is done, reboot the system.

System Utility Diskette

This utility diskette is for the Acer TravelMate 730 notebook machine. It provides the following functions:

1. Panel ID Utility
2. Thermal & Fan Utility
3. Main Board Data Utility

To use this diskette, first boot from this diskette, then a "Microsoft Windows 98 Startup Menu" prompt you to choose the testing item. Follow the instructions on screen to proceed.

NOTE: This program contains a readme.txt file. This readme.txt file will introduce each test utility and its functions.

IMPORTANT: If this diskette is not bootable, do the following actions before you use it:

1. Do system transfers.
2. Copy HIMEM.SYS to A:\.
3. Copy EMM386.EXE to A:\.

Panel ID Utility

There is an EEPROM in the inverter which stores its supported LCD type ID code. If you replace an LCD with one of a different brand or use a new inverter, the ID information in the inverter EEPROM should be updated.

Follow the steps below to see the LCD Panel ID:

1. Follow the instruction on screen to read current or to set new LCD Panel ID code.

NOTE: When you set a new LCD Panel ID and the new LCD is not yet enabled (to function), so connect an external CRT to see the program execution process.

NOTE: Make sure the new ID code you choose corresponds with the LCD brand and type. If you write a wrong ID into inverter, just reboot and re-execute the program and input the correct ID code.

2. Restart computer - the new LCD should work normally.

NOTE: If LCD cannot display after change ID code, make sure you write the correct ID code, or try reconnecting the LCD FPC cable connectors.

Thermal and Fan Utility

The system is equipped with sensors to protect against system overheating. By setting System and processor thermal thresholds, the system can turn on the cooling fan or shut down automatically when temperatures reach the defined threshold parameters. This utility will test fan, processor thermal and system thermal.

Main Board Data Utility

This utility will display Main Board Data (MBD) which include header information, product name, manufacture name, UUID (Universally Unique IDentifiers) and serial number. This function can display and create MBD data as well as store those information to LCD inverter EEPROM (not flash ROM).

System Diagnostic Diskette

IMPORTANT: ¹The diagnostics program here that we used is called PQA (Product Quality Assurance) and is provided by Acer Headquarters. You can utilize it as a basic diagnostic tool. To get this program, either download it from <http://csd.acer.com.tw> or find it in the TravelMate 730 service CD kit. To better fit local service requirements, your regional office MAY have other diagnostic program. Please contact your regional offices or the responsible personnel/channel to provide you with further technical details.

NOTE: This program contains a readme.txt file. This readme.txt file will introduce each test and its functions.

This diagnostic program divided into two diskettes is for the Acer TravelMate 730 notebook machine. It provides the following functions:

Disk 1:

1. PQA System Diagnostics
2. Audio Resource and Speaker Out Test
3. USB Register and Connect/Disconnect Test

NOTE: The USB setting in BIOS Setup must be set to enable and a USB device is required when executing USB Connection/Disconnection Test, or this test fails.

4. Exit

To use this diskette, first boot from this diskette, then a "Microsoft Windows 98 Startup Menu" prompts you to choose the testing item. Follow the instructions on screen to proceed.

IMPORTANT: If this diskette is not bootable, do the following actions before you use it:

1. Do system transfers.
2. Copy the following files to A:\
HIMEM.SYS
MSCDEX.EXE
LASTDRV.COM
RAMDRIVE.SYS

Disk 2:

1. Infrared Ray Test

NOTE: The Infrared Ray setting in BIOS Setup must be set to enable when executing the Infrared Ray Test.

2. Modem Test

NOTE: A phone line is required for the modem test.

To use this diskette, first boot from this diskette, then a "Microsoft Windows 98 Startup Menu" prompts you to choose the testing item. Follow the instructions on screen to proceed.

IMPORTANT: If this diskette is not bootable, do the following actions before you use it:

1. Do system transfers.
2. Copy the following files to A:\
HIMEM.SYS
EMM386.EXE
CHOICE.COM

NOTE: When executing a parallel or serial port test in System Test item, a loopback tool is needed. This loopback is Acer proprietary design. You may reach the computerhwdoctor@acer.com.tw for ordering information.

¹ New added description. Please pay attention to it.

Running PQA Diagnostics Program

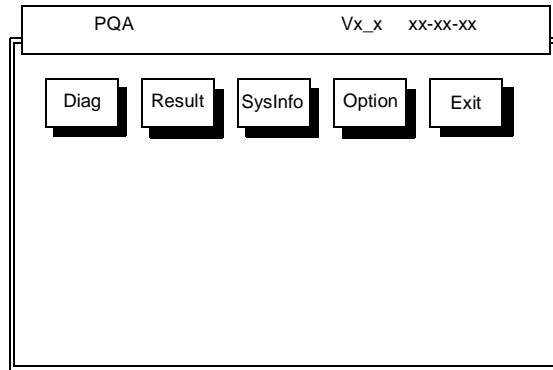

Press →← to move around the main menu. Press Enter to enable the selected option. The main options are Diag, Result, SysInfo, Option and Exit.

The Diag option lets you select testing items and times.

The following screen appears when you select Diag from the main menu.

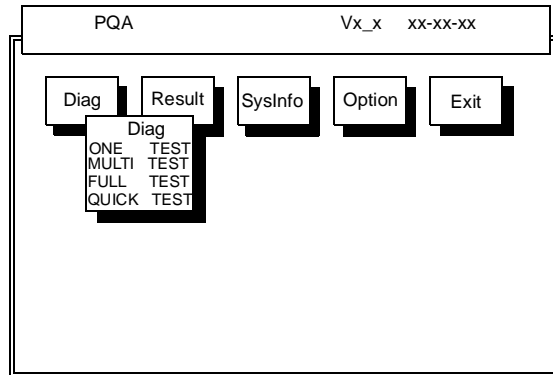

One Test performs a single test and Manual checks the selected test items in sequence.

Multi Test performs multiple tests of the selected items and check the selected test items in sequence.

Full Test performs all test items in detail for your system.

Quick Test performs all test items quickly for your system.

The screen below appears if you select Multi Test.

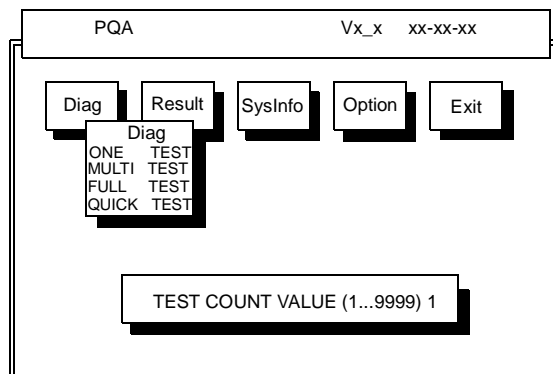

Specify the desired number of tests and press **Enter**.

After you specify the number of tests to perform, the screen shows a list of test items (see below).

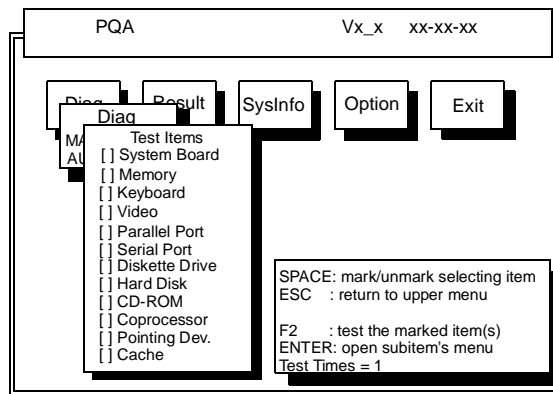

Move the highlight bar from one item to another. Press Space to enable or disable the item. Press **Enter** to view the available options of each selected item. Press **Esc** to close the submenu.

The right corner screen information gives you the available function keys and the specified test number.

- Space: Enables/disables the item
- ESC: Exits the program
- F1: Help
- F2: Tests the selected item(s)
- Enter: Opens the available options
- Test Times: Indicates the number of tests to perform.

NOTE: The F1 and F2 keys function only after you finish configuring the Test option.

Machine Disassembly and Replacement

This chapter contains step-by-step procedures on how to disassemble the notebook computer for maintenance and troubleshooting.

To disassemble the computer, you need the following tools:

- Wrist grounding strap and conductive mat for preventing electrostatic discharge
- Flat-bladed screw driver
- Phillips screw driver
- Tweezers
- Flat-bladed screw driver or plastic stick

NOTE: The screws for the different components vary in size. During the disassembly process, group the screws with the corresponding components to avoid mismatch when putting back the components.

General Information

Before You Begin

Before proceeding with the disassembly procedure, make sure that you do the following:

1. Turn off the power to the system and all peripherals.
2. Unplug the AC adapter and all power and signal cables from the system.
3. Remove the battery pack.

Disassembly Procedure Flowchart

The flowchart on the succeeding page gives you a graphic representation on the entire disassembly sequence and instructs you on the components that need to be removed during servicing. For example, if you want to remove the system board, you must first remove the keyboard, then disassemble the inside assembly frame in that order.

DISASSEMBLY FLOWCHART OF TM730

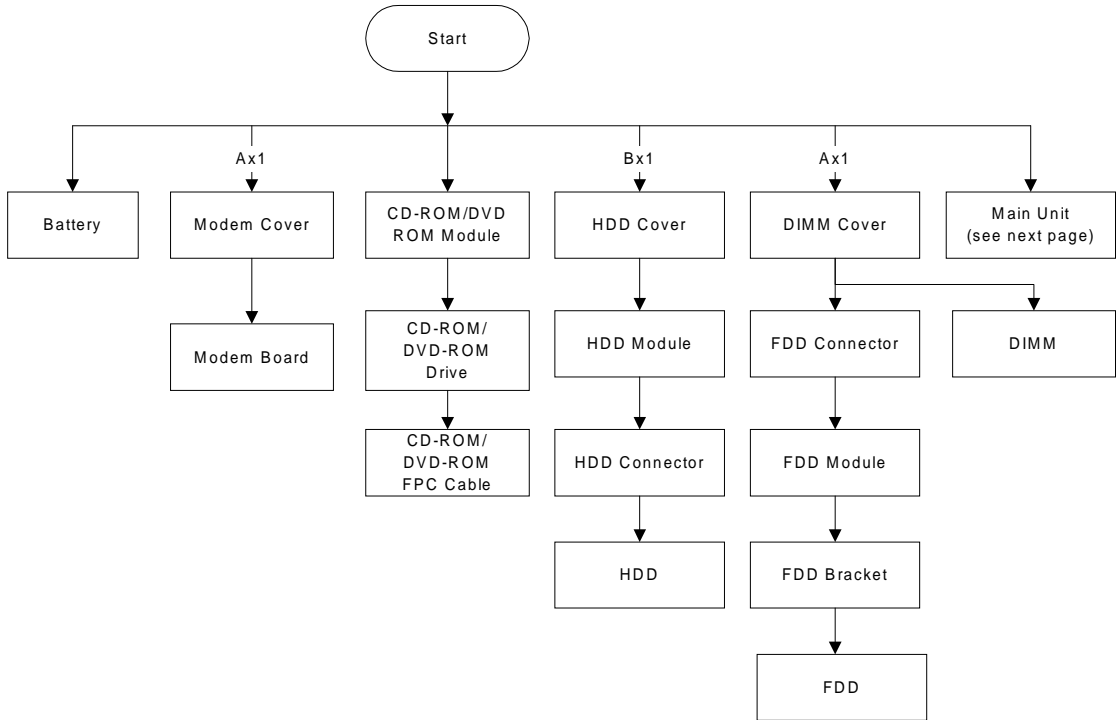

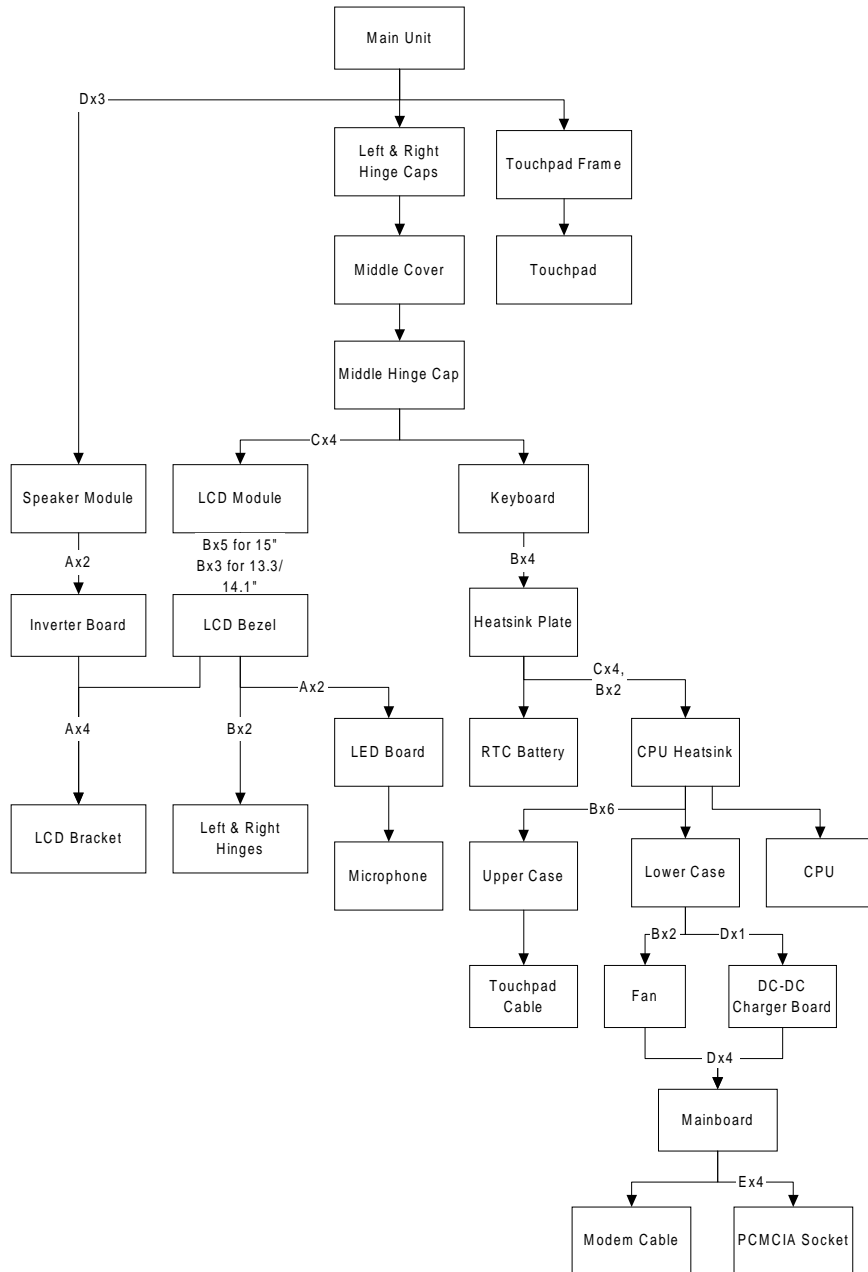

Screw List

Item	Description
A	Screw M2 X L4 (Black)
B	Screw M2.5 X L6 (Black)
C	Screw M2.5 X L10 ((Black)
D	Screw M2.5 X L3.5 (Black)
E	Screw M2 X L4 (Silver)

Removing the Battery Pack

1. Push the battery release button inward.
2. Slide the battery pack out from the main unit.

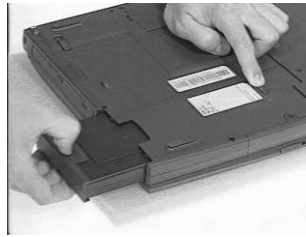

Removing the External DIMM Module

1. Remove the screw of the DIMM cover, then remove the DIMM cover from the lower case.



2. Use two flat-bladed screw drivers to push out the latches on either side of the DIMM socket and remove the DIMM memory.



Removing the External Modem Combo Card

1. Remove the screw holding the modem cover.
2. Use two flat-bladed screw drivers to push out the latches on either side of the modem socket.



3. Remove the modem board from the mainboard.
4. Disconnect the modem power cable from the modem board.

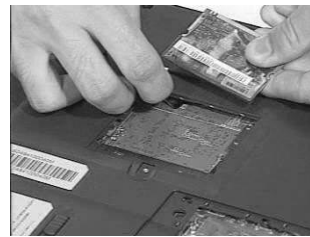
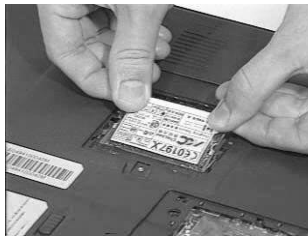

Removing the CD-ROM/DVD-ROM Module

1. Push the CD-ROM module release button inward.
2. Slide the CD-ROM module out from the main unit.

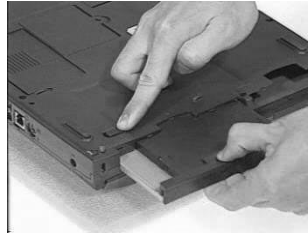

Removing the Hard Disk Drive Module

1. Remove the screw of the hard disk cover, then remove the HDD cover.
2. Pull the plastic tag to remove the HDD module.

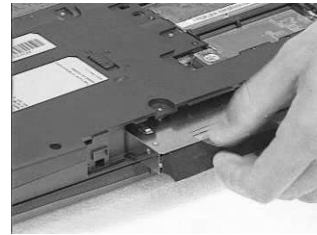

Removing the Floppy Disk Drive Module

1. Remove the screw as shown here.
2. Disconnect the FDD FPC cable.
3. Slide out the FDD module from the upper case smoothly.

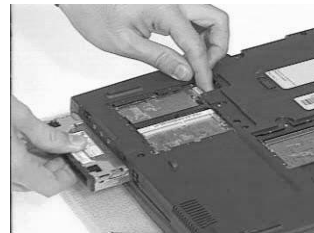
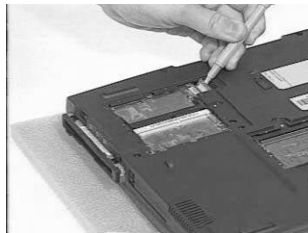
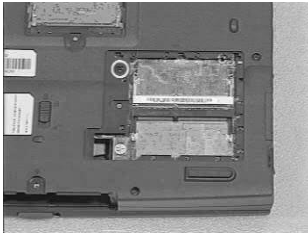

WARNING: Be careful not to break the FDD FPC cable, when sliding out the module.

Disassembling the Main Unit

Removing the Keyboard

1. First, release the left and right hinge caps.
2. Slide the middle cover to the right, then remove it from the main unit.



3. Release the middle hinge cap.
4. Hold the keyboard upward.

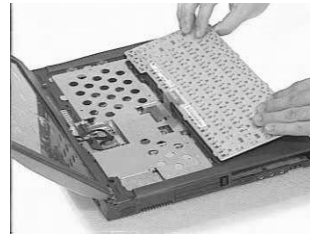

5. Disconnect the keyboard cable from the mainboard.
6. Remove the keyboard.

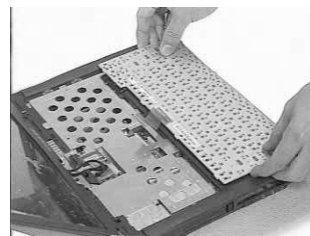
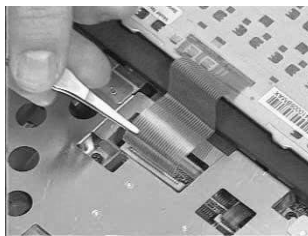

Removing the LCD Module

1. Remove the two screws as shown.
2. Disconnect the LED/inverter board FPC cable and the LCD FPC cable from the mainboard.

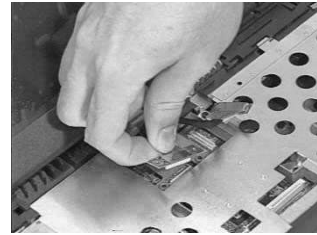
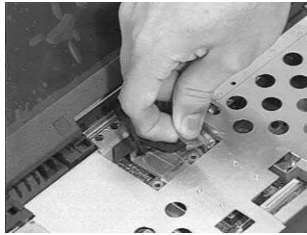
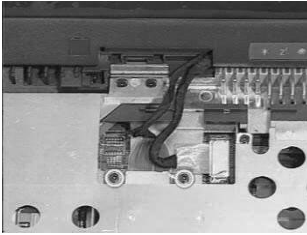

3. Release the two screws on the main unit.
4. Lift up the LCD module cautiously.

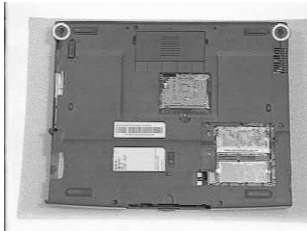

Removing the TouchPad Module

1. Use a flat-bladed plastic screw driver to detach the touchpad frame from the upper case.
2. Remove the left and right touchpad button and the touchpad lower button.

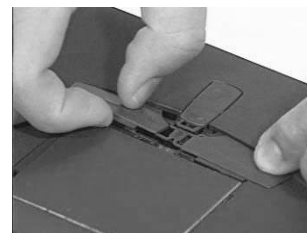
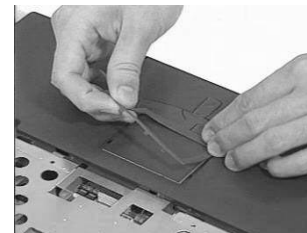
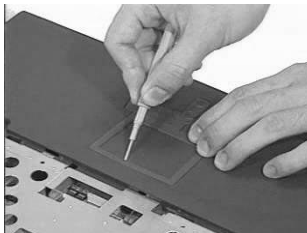

3. Disconnect the touchpad cable
4. Remove the touchpad board.

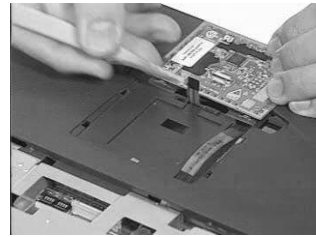
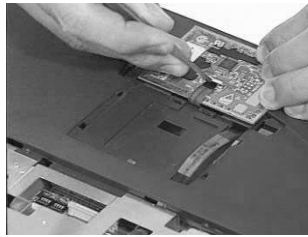
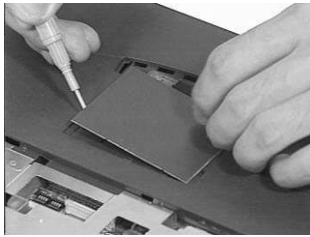

Removing the CPU

1. Release the four screws on the heatsink plate.
2. Remove the heatsink plate.

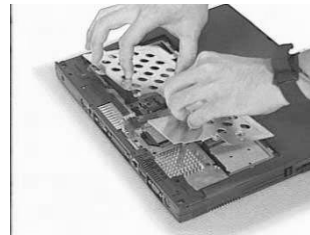
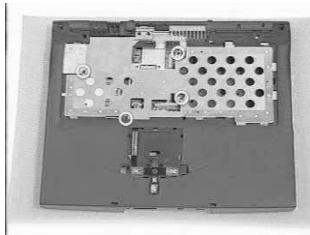

3. Release the six screws on the CPU heatsink.
4. Remove the CPU heatsink.

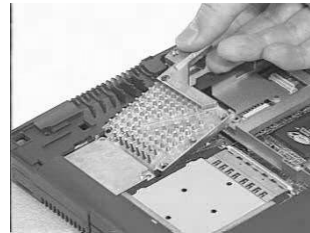
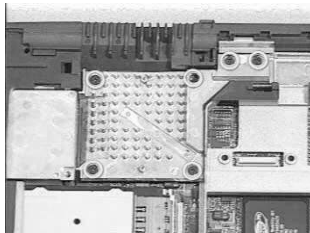

5. Loosen up the CPU secure knot.
6. Remove the CPU.

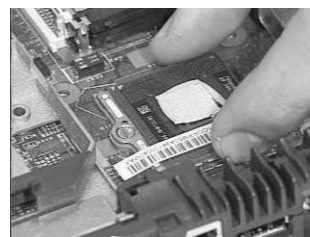
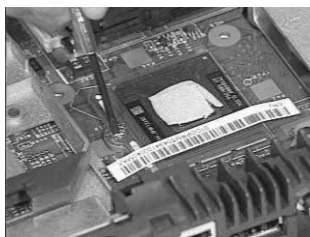

Removing the RTC

1. Use a plastic flat bladed screw driver to remove the RTC battery from its socket

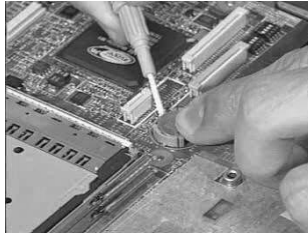

NOTE: To replace the RTC battery, press the RTC battery into the socket.

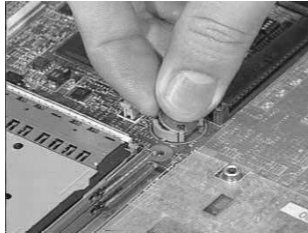

Separating the Lower Case from the Upper Case

1. Disconnect the touchpad cable from the mainboard.

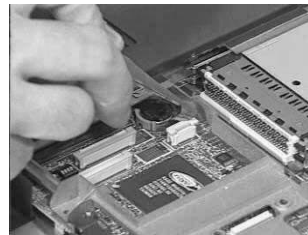
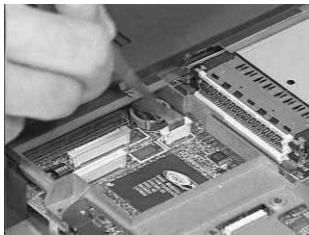

2. Release the six screws from the bottom of the main unit as shown below.
3. Remove the upper case backward.

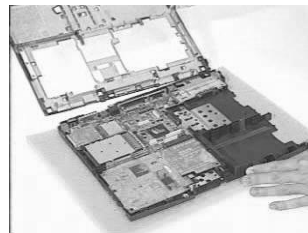
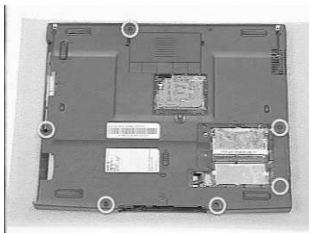

4. Disconnect the LCD cover switch connector from the mainboard.
5. Separate the upper case from the lower case.

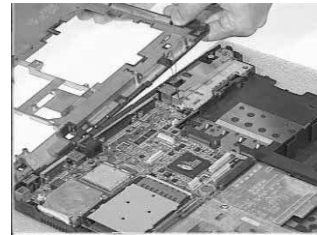
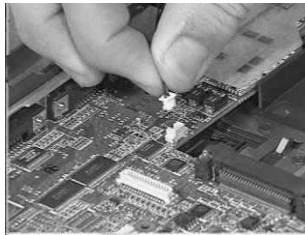
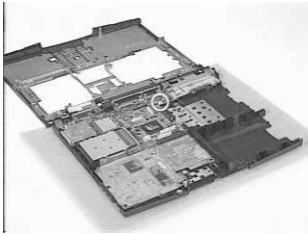

Removing the Fan

1. Remove the fan cable from the mainboard.
2. Release the two screws.
3. Remove the fan from the mainboard.

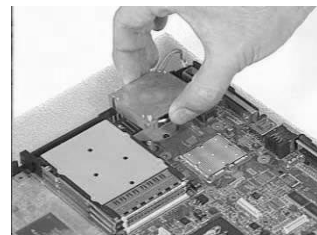
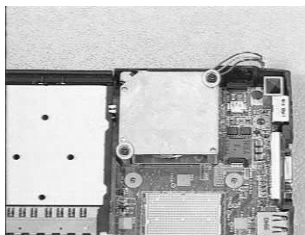
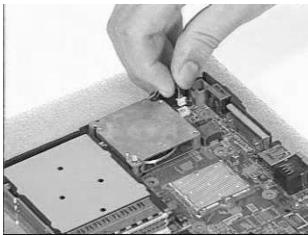

Removing the DC-DC Charger Board

1. Release the screw as shown.
2. Remove the DC-DC charger board from the mainboard.

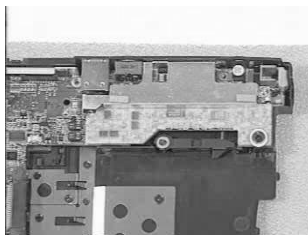

Removing the System Board

1. Remove the four screws on the mainboard as shown below.
2. Remove the mainboard from the lower case with caution.

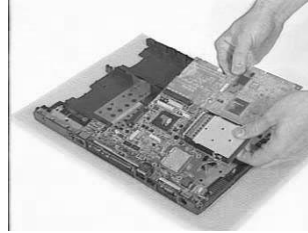
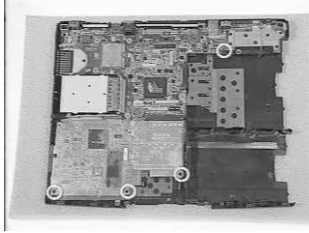

Removing the Audio Jack Cover

1. Remove the audio jack cover from the mainboard.

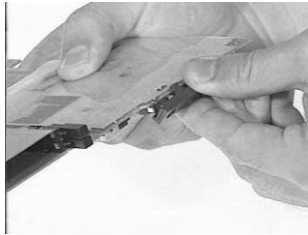

Removing the PCMCIA Socket

1. From the back of the mainboard, release the four screws as shown below.
2. Detach the PCMCIA socket from the mainboard.

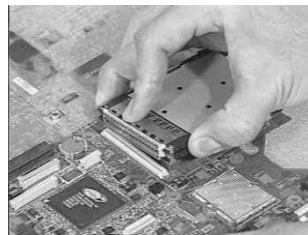
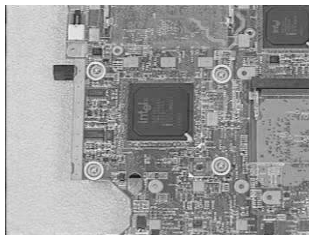

Removing the Modem Power Cable

1. Disconnect the modem power cable from the mainboard.
2. Remove the cable.

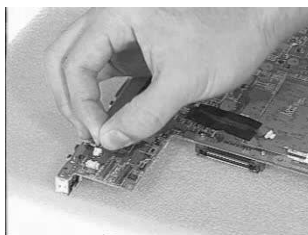

Disassembling the LCD Module

Removing the LCD Bezel

1. Remove the five mylars from the LCD module.

NOTE: 13.3" and 14.1" LCD have 5 mylars; 15" has only 3 mylars.

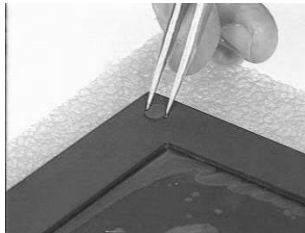
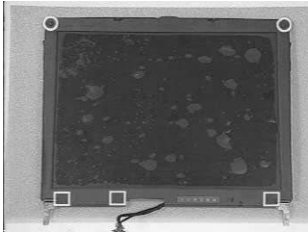

2. Remove the five screws from the LCD module.

NOTE: 13.3" and 14.1" LCD have 5 screws; 15" has only 3 screws.

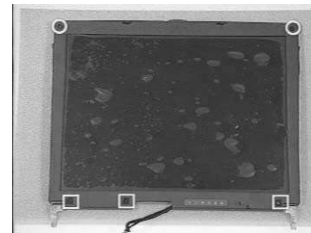

3. Snap the LCD bezel off carefully.

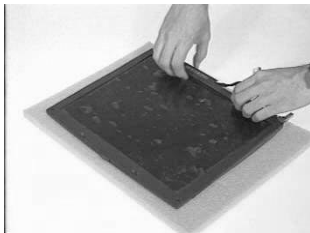

Removing the Speaker Assembly Module

1. Turn the LCD module over.

WARNING: Be careful not to break the LCD panel. Place a soft cushion below the LCD panel.

2. Remove the three mylars and the three screws from the speaker module.

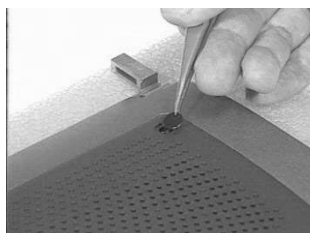

3. Remove the speaker to LED cable.
4. Remove the speaker assembly module.

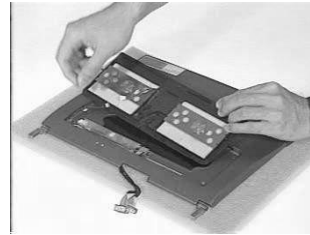

Removing the Inverter Board

1. Remove the LCD power cable and inverter to LED cable from the inverter.

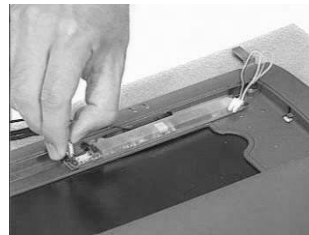
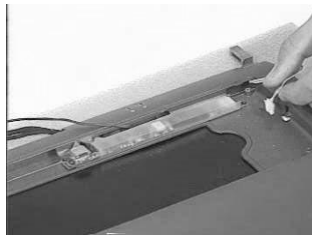

2. Remove the two screws as shown below.
3. Remove the inverter board.

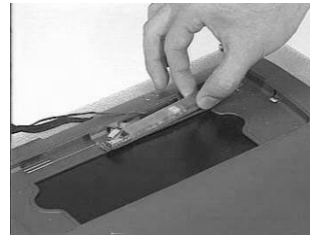
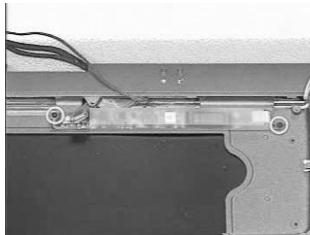

Removing the LCD Bracket

1. Release the four screws as shown below.
2. Take out the LCD panel from the LCD module carefully.

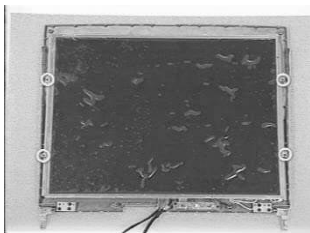

3. Release the two screws on the left side of the LCD panel.
4. Do the same for removing the two screws on the right side of the LCD panel.
5. Remove the left and right LCD brackets.

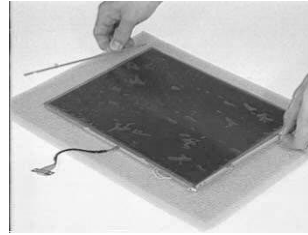
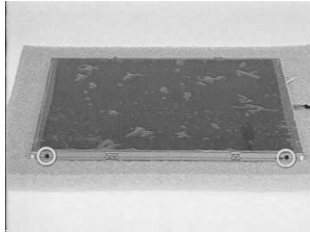

Removing the LED Board

1. Remove the two screws as shown below.
2. Disconnect the microphone cable.

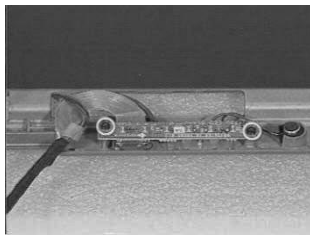

3. Disconnect the inverter to led cable, and speaker to led cable.
4. Remove the LED board.

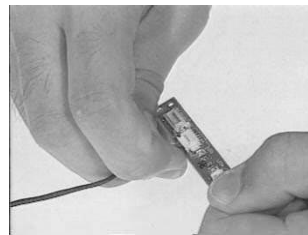
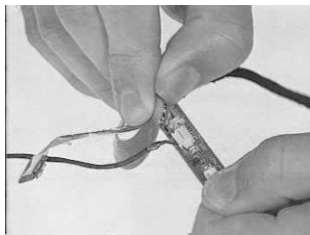

Removing the Microphone

1. Remove the microphone from the LCD module.



Removing the Left and Right Hinges

1. Release the two screws as shown below.
2. Remove the left and right hinges.

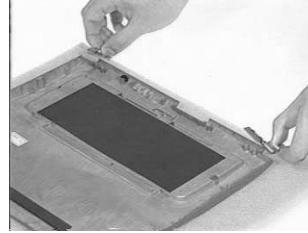
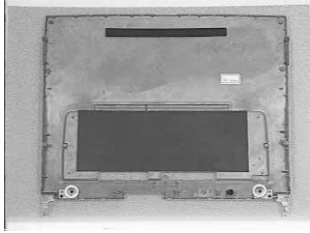

Troubleshooting

Use the following procedure as a guide for computer problems.

NOTE: The diagnostic tests are intended to test only Acer products. Non-Acer products, prototype cards, or modified options can give false errors and invalid system responses.

1. Obtain the failing symptoms in as much detail as possible.
2. Verify the symptoms by attempting to re-create the failure by running the diagnostic test or by repeating the same operation.
3. Use the following table with the verified symptom to determine which page to go to.

Symptoms (Verified)	Go To
Power failure. (The power indicator does not go on or stay on.)	"Power System Check" on page 59.
POST does not complete. No beep or error codes are indicated.	"Power-On Self-Test (POST) Error Message" on page 61 "Undetermined Problems" on page 68
POST detects an error and displayed messages on screen.	"Error Message List" on page 62
The diagnostic test detected an error and displayed a FRU code.	"Running PQA Diagnostics Program" on page 34
Other symptoms (i.e. LCD display problems or others).	"Power-On Self-Test (POST) Error Message" on page 61
Symptoms cannot be re-created (intermittent problems).	Use the customer-reported symptoms and go to "Power-On Self-Test (POST) Error Message" on page 61 "Intermittent Problems" on page 67 "Undetermined Problems" on page 68

System Check Procedures

External Diskette Drive Check

Do the following to isolate the problem to a controller, driver, or diskette. A write-enabled, diagnostic diskette is required.

NOTE: Make sure that the diskette does not have more than one label attached to it. Multiple labels can cause damage to the drive or cause the drive to fail.

Do the following to select the test device. See “Running PQA Diagnostics Program” on page 34 for details.

1. Boot from the diagnostics diskette and start the PQA program (see “Running PQA Diagnostics Program” on page 34).
2. Go to the diagnostic Diskette Drive in the test items.
3. Press F2 in the test items.
4. Follow the instructions in the message window.

If an error occurs with the internal diskette drive, reconnect the diskette connector on the system board.

If the error still remains:

1. Reconnect the external diskette drive/CD-ROM module.
2. Replace the external diskette drive/CD-ROM module.
3. Replace the system board.

External CD-ROM Drive Check

Do the following to isolate the problem to a controller, drive, or CD-ROM. Make sure that the CD-ROM does not have any label attached to it. The label can cause damage to the drive or can cause the drive to fail.

Do the following to select the test device:

1. Boot from the diagnostics diskette and start the PQA program (refer to “Running PQA Diagnostics Program” on page 34).
2. Go to the diagnostic CD-ROM in the test items.
3. Press F2 in the test items.
4. Follow the instructions in the message window.

If an error occurs, reconnect the connector on the System board. If the error still remains:

1. Reconnect the external diskette drive/CD-ROM module.
2. Replace the external diskette drive/CD-ROM module.
3. Replace the system board.

Keyboard or Auxiliary Input Device Check

Remove the external keyboard if the internal keyboard is to be tested.

If the internal keyboard does not work or an unexpected character appears, make sure that the flexible cable extending from the keyboard is correctly seated in the connector on the system board.

If the keyboard cable connection is correct, run the Keyboard Test. See “Running PQA Diagnostics Program” on page 34 for details.

If the tests detect a keyboard problem, do the following one at a time to correct the problem. Do not replace a non-defective FRU:

1. Reconnect the keyboard cables.
2. Replace the keyboard.
3. Replace the system board.

The following auxiliary input devices are supported by this computer:

- Numeric keypad
- External keyboard

If any of these devices do not work, reconnect the cable connector and repeat the failing operation.

Memory Check

Memory errors might stop system operations, show error messages on the screen, or hang the system.

1. Boot from the diagnostics diskette and start the PQA program (please refer to “Running PQA Diagnostics Program” on page 34).
2. Go to the diagnostic memory in the test items.
3. Press F2 in the test items.
4. Follow the instructions in the message window.

NOTE: Make sure that the DIMM is fully installed into the connector. A loose connection can cause an error.

Power System Check

To verify the symptom of the problem, power on the computer using each of the following power sources:

1. Remove the battery pack.
2. Connect the power adapter and check that power is supplied.
3. Disconnect the power adapter and install the charged battery pack; then check that power is supplied by the battery pack.

If you suspect a power problem, see the appropriate power supply check in the following list:

- “Check the Power Adapter” on page 59
- “Check the Battery Pack” on page 60

Check the Power Adapter

Unplug the power adapter cable from the computer and measure the output voltage at the plug of the power adapter cable. See the following figure

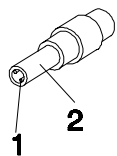

Pin 1: +19 to +20.5V
Pin 2: 0V, Ground

1. If the voltage is not correct, replace the power adapter.
2. If the voltage is within the range, do the following:
 - Replace the System board.
 - If the problem is not corrected, see “Undetermined Problems” on page 68.
 - If the voltage is not correct, go to the next step.

NOTE: An audible noise from the power adapter does not always indicate a defect.

3. If the power-on indicator does not light up, check the power cord of the power adapter for correct continuity and installation.
4. If the operational charge does not work, see “Check the Battery Pack” on page 60.

Check the Battery Pack

To check the battery pack, do the following:

From Software:

1. Check out the Power Management in control Panel
2. In Power Meter, confirm that if the parameters shown in the screen for Current Power Source and Total Battery Power Remaining are correct.
3. Repeat the steps 1 and 2, for both battery and adapter.
4. This helps you identify first the problem is on recharging or discharging.

From Hardware:

1. Power off the computer.
2. Remove the battery pack and measure the voltage between battery terminals 1(+) and 6(ground). See the following figure

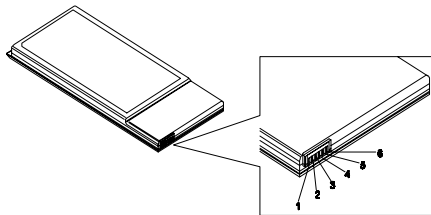

3. If the voltage is still less than 7.5 Vdc after recharging, replace the battery.

To check the battery charge operation, use a discharged battery pack or a battery pack that has less than 50% of the total power remaining when installed in the computer.

If the battery status indicator does not light up, remove the battery pack and let it return to room temperature. Re-install the battery pack.

If the charge indicator still does not light up, replace the battery pack. If the charge indicator still does not light up, replace the DC/DC charger board.

Touchpad Check

If the touchpad doesn't work, do the following actions one at a time to correct the problem. Do not replace a non-defective FRU:

1. Reconnect the touchpad cables.
2. Replace the touchpad.
3. Replace the system board.

After you use the touchpad, the pointer drifts on the screen for a short time. This self-acting pointer movement can occur when a slight, steady pressure is applied to the touchpad pointer. This symptom is not a hardware problem. No service actions are necessary if the pointer movement stops in a short period of time.

Power-On Self-Test (POST) Error Message

The POST error message index lists the error message and their possible causes. The most likely cause is listed first.

NOTE: Perform the FRU replacement or actions in the sequence shown in FRU/Action column, if the FRU replacement does not solve the problem, put the original part back in the computer. Do not replace a non-defective FRU.

This index can also help you determine the next possible FRU to be replaced when servicing a computer.

If the symptom is not listed, see “Undetermined Problems” on page 68.

The following lists the error messages that the BIOS displays on the screen and the error symptoms classified by function.

NOTE: Most of the error messages occur during POST. Some of them display information about a hardware device, e.g., the amount of memory installed. Others may indicate a problem with a device, such as the way it has been configured.

NOTE: If the system fails after you make changes in the BIOS Setup Utility menus, reset the computer, enter Setup and install Setup defaults or correct the error.

Index of Error Messages

Error Message List

Error Messages	FRU/Action in Sequence
Failure Fixed Disk	Reconnect hard disk drive connector. "Load Default Settings" in BIOS Setup Utility. Hard disk drive System board
Stuck Key	see "Keyboard or Auxiliary Input Device Check" on page 58 .
Keyboard error	see "Keyboard or Auxiliary Input Device Check" on page 58.
Keyboard Controller Failed	see "Keyboard or Auxiliary Input Device Check" on page 58.
Keyboard locked - Unlock key switch	Unlock external keyboard
Monitor type does not match CMOS - Run Setup	Run "Load Default Settings" in BIOS Setup Utility.
Shadow RAM Failed at offset: nnnn	BIOS ROM System board
System RAM Failed at offset: nnnn	DIMM System board
Extended RAM Failed at offset: nnnn	DIMM System board
System battery is dead - Replace and run Setup	Replace RTC battery and Run BIOS Setup Utility to reconfigure system time, then reboot system.
System CMOS checksum bad - Default configuration used	RTC battery Run BIOS Setup Utility to reconfigure system time, then reboot system.
System timer error	RTC battery Run BIOS Setup Utility to reconfigure system time, then reboot system. System board
Real time clock error	RTC battery Run BIOS Setup Utility to reconfigure system time, then reboot system. System board
Previous boot incomplete - Default configuration used	Run "Load Default Settings" in BIOS Setup Utility. RTC battery System board
Memory size found by POST differed from CMOS	Run "Load Default Settings" in BIOS Setup Utility. DIMM System board
Diskette drive A error	Check the drive is defined with the proper diskette type in BIOS Setup Utility See "External Diskette Drive Check" on page 58.
Incorrect Drive A type - run SETUP	Check the drive is defined with the proper diskette type in BIOS Setup Utility See "External Diskette Drive Check" on page 58.
System cache error - Cache disabled	System board
CPU ID:	System board
DMA Test Failed	DIMM System board
Software NMI Failed	DIMM System board
Fail-Safe Timer NMI Failed	DIMM System board

Error Message List

Error Messages	FRU/Action in Sequence
Device Address Conflict	Run "Load Default Settings" in BIOS Setup Utility. RTC battery System board
Allocation Error for device	Run "Load Default Settings" in BIOS Setup Utility. RTC battery System board
Failing Bits: nnnn	DIMM BIOS ROM System board
Fixed Disk n	None
Invalid System Configuration Data	BIOS ROM System board
I/O device IRQ conflict	Run "Load Default Settings" in BIOS Setup Utility. RTC battery System board
Operating system not found	Enter Setup and see if fixed disk and drive A: are properly identified. Diskette drive Hard disk drive System board

Error Message List

No beep Error Messages	FRU/Action in Sequence
No beep, power-on indicator turns off and LCD is blank.	Power source (battery pack and power adapter). See "Power System Check" on page 59. Ensure every connector is connected tightly and correctly. Reconnect the DIMM. LED board. System board.
No beep, power-on indicator turns on and LCD is blank.	Power source (battery pack and power adapter). See "Power System Check" on page 59. Reconnect the LCD connector Hard disk drive LCD inverter ID LCD cable LCD Inverter LCD System board
No beep, power-on indicator turns on and LCD is blank. But you can see POST on an external CRT.	Reconnect the LCD connectors. LCD inverter ID LCD cable LCD inverter LCD System board
No beep, power-on indicator turns on and a blinking cursor shown on LCD during POST.	Ensure every connector is connected tightly and correctly. System board
No beep during POST but system runs correctly.	Speaker System board

Index of Symptom-to-FRU Error Message

LCD-Related Symptoms

Symptom / Error	Action in Sequence
LCD backlight doesn't work LCD is too dark LCD brightness cannot be adjusted LCD contrast cannot be adjusted	Enter BIOS Utility to execute "Load Setup Default Settings", then reboot system. Reconnect the LCD connectors. Keyboard (if contrast and brightness function key doesn't work). LCD inverter ID LCD cable LCD inverter LCD System board
Unreadable LCD screen Missing pels in characters Abnormal screen Wrong color displayed	Reconnect the LCD connector LCD inverter ID LCD cable LCD inverter LCD System board
LCD has extra horizontal or vertical lines displayed.	LCD inverter ID LCD inverter LCD cable LCD System board

Indicator-Related Symptoms

Symptom / Error	Action in Sequence
Indicator incorrectly remains off or on, but system runs correctly	Reconnect the inverter board Inverter board System board

Power-Related Symptoms

Symptom / Error	Action in Sequence
Power shuts down during operation	Power source (battery pack and power adapter). See "Power System Check" on page 59. Battery pack Power adapter Hard drive & battery connection board System board
The system doesn't power-on.	Power source (battery pack and power adapter). See "Power System Check" on page 59. Battery pack Power adapter Hard drive & battery connection board System board
The system doesn't power-off.	Power source (battery pack and power adapter). See "Power System Check" on page 59. Hold and press the power switch for more than 4 seconds. System board
Battery can't be charged	See "Check the Battery Pack" on page 60. Battery pack System board

PCMCIA-Related Symptoms

Symptom / Error	Action in Sequence
System cannot detect the PC Card (PCMCIA)	PCMCIA slot assembly System board
PCMCIA slot pin is damaged.	PCMCIA slot assembly

Memory-Related Symptoms

Symptom / Error	Action in Sequence
Memory count (size) appears different from actual size.	Enter BIOS Setup Utility to execute "Load Default Settings, then reboot system. DIMM System board

Speaker-Related Symptoms

Symptom / Error	Action in Sequence
In Windows, multimedia programs, no sound comes from the computer.	Audio driver Speaker System board
Internal speakers make noise or emit no sound.	Speaker System board

Power Management-Related Symptoms

Symptom / Error	Action in Sequence
The system will not enter hibernation	Keyboard (if control is from the keyboard) Hard disk drive System board
The system doesn't enter hibernation mode and four short beeps every minute.	See "Hibernation Mode" on page 20. Press Fn+F4 and see if the computer enters hibernation mode. Touchpad Keyboard Hard disk connection board Hard disk drive System board
The system doesn't enter standby mode after closing the LCD	See "Standby Mode" on page 19. LCD cover switch System board
The system doesn't resume from hibernation mode.	See "Hibernation Mode" on page 20. Hard disk connection board Hard disk drive System board
The system doesn't resume from standby mode after opening the LCD.	See "Standby Mode" on page 19. LCD cover switch System board
Battery fuel gauge in Windows doesn't go higher than 90%.	Remove battery pack and let it cool for 2 hours. Refresh battery (continue use battery until power off, then charge battery). Battery pack System board

Power Management-Related Symptoms

Symptom / Error	Action in Sequence
System hangs intermittently.	See "Thermal and Fan Utility" on page 32. Reconnect hard disk/CD-ROM drives. Hard disk connection board System board

Peripheral-Related Symptoms

Symptom / Error	Action in Sequence
System configuration does not match the installed devices.	Enter BIOS Setup Utility to execute "Load Default Settings", then reboot system. Reconnect hard disk/CD-ROM/diskette drives.
External display does not work correctly.	Press Fn+F5, LCD/CRT/Both display switching See "Running PQA Diagnostics Program" on page 34. System board
USB does not work correctly	See "System Diagnostic Diskette" on page 33 System board
Print problems.	Ensure the "Parallel Port" in the "Onboard Devices Configuration" of BIOS Setup Utility is set to Enabled. Onboard Devices Configuration Run printer self-test. Printer driver Printer cable Printer System Board
Serial or parallel port device problems.	Ensure the "Serial Port" in the Devices Configuration" of BIOS Setup Utility is set to Enabled. Device driver Device cable Device System board

Keyboard/Touchpad-Related Symptoms

Symptom / Error	Action in Sequence
Keyboard (one or more keys) does not work.	Reconnect the keyboard cable. Keyboard System board
Touchpad does not work.	Reconnect touchpad cable. Touchpad board System board

Modem-Related Symptoms

Symptom / Error	Action in Sequence
Internal modem does not work correctly.	See "System Diagnostic Diskette" on page 33. Modem phone port modem combo board System board

NOTE: If you cannot find a symptom or an error in this list and the problem remains, see "Undetermined Problems" on page 68.

Intermittent Problems

Intermittent system hang problems can be caused by a variety of reasons that have nothing to do with a hardware defect, such as: cosmic radiation, electrostatic discharge, or software errors. FRU replacement should be considered only when a recurring problem exists.

When analyzing an intermittent problem, do the following:

1. Run the advanced diagnostic test for the system board in loop mode at least 10 times.
2. If no error is detected, do not replace any FRU.
3. If any error is detected, replace the FRU. Rerun the test to verify that there are no more errors.

Undetermined Problems

The diagnostic problems does not identify which adapter or device failed, which installed devices are incorrect, whether a short circuit is suspected, or whether the system is inoperative.

Follow these procedures to isolate the failing FRU (do not isolate non-defective FRU).

NOTE: Verify that all attached devices are supported by the computer.

NOTE: Verify that the power supply being used at the time of the failure is operating correctly. (See "Power System Check" on page 59):

1. Power-off the computer.
2. Visually check them for damage. If any problems are found, replace the FRU.
3. Remove or disconnect all of the following devices:
 - Non-Acer devices
 - Printer, mouse, and other external devices
 - Battery pack
 - Hard disk drive
 - DIMM
 - CD-ROM/Diskette drive Module
 - PC Cards
4. Power-on the computer.
5. Determine if the problem has changed.
6. If the problem does not recur, reconnect the removed devices one at a time until you find the failing FRU.
7. If the problem remains, replace the following FRU one at a time. Do not replace a non-defective FRU:
 - System board
 - LCD assembly

Index of AFlash BIOS Error Message

Error Message	Action in Sequence
Hardware Error	See "System Diagnostic Diskette" on page 33
VPD Checksum Error	Reboot the system and then retest with this diskette.
BIOS Update Program Error	Turn off the power and restart the system.
System Error	Make sure this AFlash BIOS diskette for this model.
Without AC adapter	make sure to connect AC adapter
Battery Low	make sure to install a highly charged battery, and reboot system.

Index of PQA Diagnostic Error Code, Message

Error Code	Message	Action in Sequence
16XXX	Backup battery error	Backup battery
01XXX	CPU or main board error	Reload BIOS default setting. System board
02XXX	Memory error	DIMM System board
03XXX	Keyboard error	Reset Keyboard Keyboard System board
04XXX	Video error	System board
05XXX	Parallel Port error	System board
06XXX	Serial port or main board error	System board
07XXX	Diskette drive error	Diskette drive System board
08XXX	Hard disk error	Reload BIOS default setting Hard disk System board
09XXX	CD-ROM error	Reset CD-ROM cable CD-ROM drive System board
10XXX	Co-processor error	System board
11XXX	Pointing device error	Reset Keyboard Keyboard System board
12XXX	Cache test error	System board

Jumper and Connector Locations

Top View

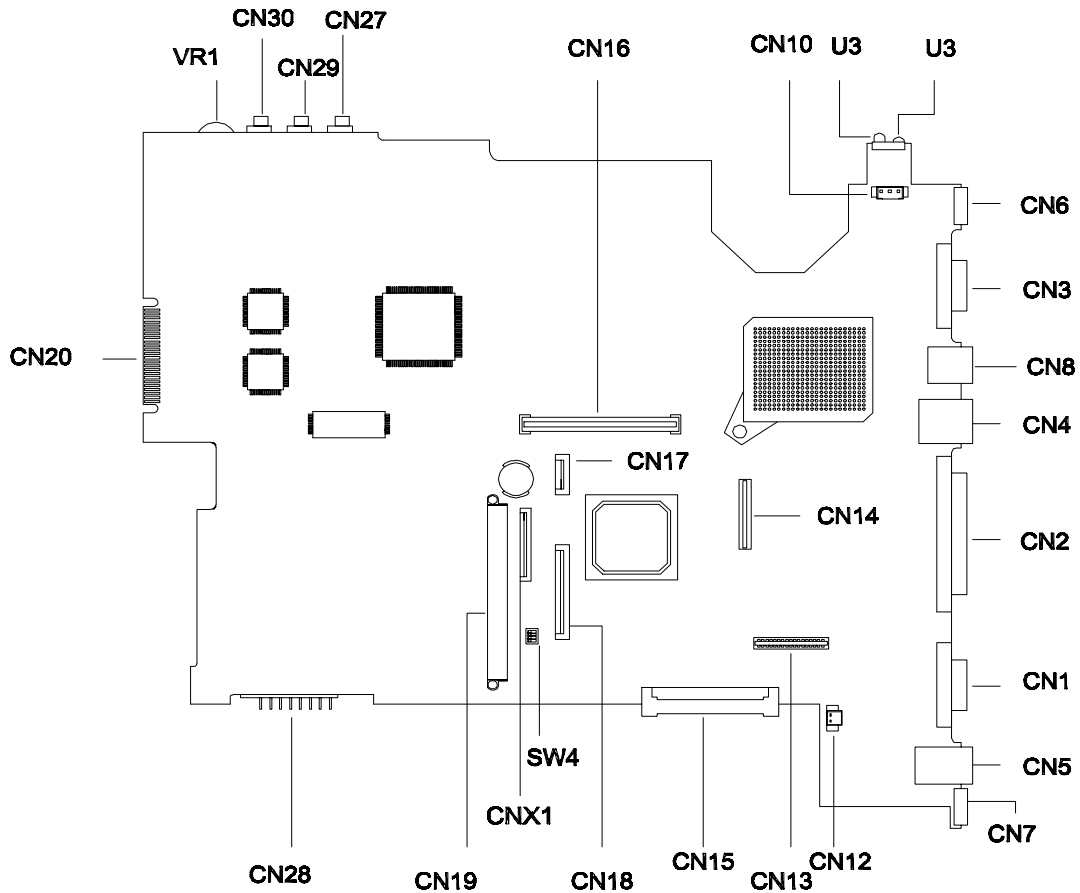

PCB 99202-SB

CN1	Serial Port	CN16	Cardbus Socket
CN2	Parallel Port	CN17	Touchpad Connector
CN3	VGA Port	CN18	Internal Keyboard Connector
CN4	LAN Connector (RJ45)	CN19	HDD Connector
CN5	Modem Connector (RJ11)	CN20	Debug Board
CN6	S-Video Port	CN27	Line-out Port
CN7	PS/2 Port	CN28	Battery Connector
CN8	USB Port	CN29	Line-in Port
CN10	FAN Connector	CN30	Microphone-in Port
CN12	LCD Cover Switch Connector	SW4	See SW4 Setting
CN13	LED/Inverter Board Connector	VR1	Volume Control
CN14	LCD FPC Connector	CNX1	Finger Print Check
CN15	External CD/DVD-ROM Module Connector		

SW4 Settings

SW4	Setting
Switch 1, Switch 2	OFF, OFF: US International keyboard ON, OFF: Japanese keyboard OFF, ON: German keyboard
Switch 3	ON: Enable BootBlock Erasable OFF: Disable BootBlock Erasable
Switch 4	ON: Disable password check OFF: Enable password check

Bottom View

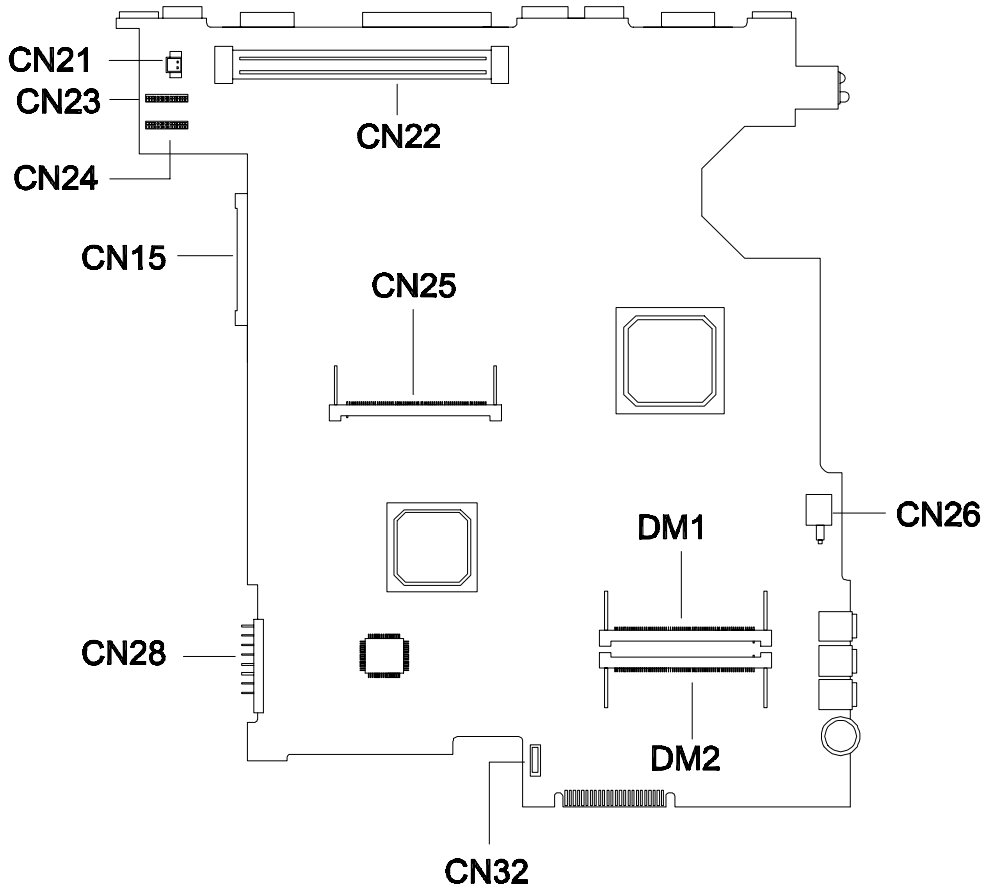

CN15	External CD/DVD-ROM Module Connector	CN26	Power Switch Connector
CN21	Modem Connector	CN28	Battery Connector
CN22	Docking Station Connector	CN32	FDD FPC Connector
CN23	DC-DC Board Connector	DM1	DIMM Socket 1
CN24	DC-DC Board Connector	DM2	DIMM Socket 2
CN25	FAX/Modem Board Socket		

FRU (Field Replaceable Unit) List

This chapter gives you the FRU (Field Replaceable Unit) listing in global configurations of TravelMate 730. Refer to this chapter whenever ordering for parts to repair or for RMA (Return Merchandise Authorization).

Please note that WHEN ORDERING FRU PARTS, you should check the most up-to-date information available on your regional web or channel. For whatever reasons a part number change is made, it will not be noted on the printed Service Guide. For ACER AUTHORIZED SERVICE PROVIDERS, your Acer office may have a DIFFERENT part number code from those given in the FRU list of this printed Service Guide. You MUST use the local FRU list provided by your regional Acer office to order FRU parts for repair and service of customer machines.

NOTE: To scrap or to return the defective parts, you should follow the local government ordinance or regulations on how to dispose it properly, or follow the rules set by your regional Acer office on how to return it.

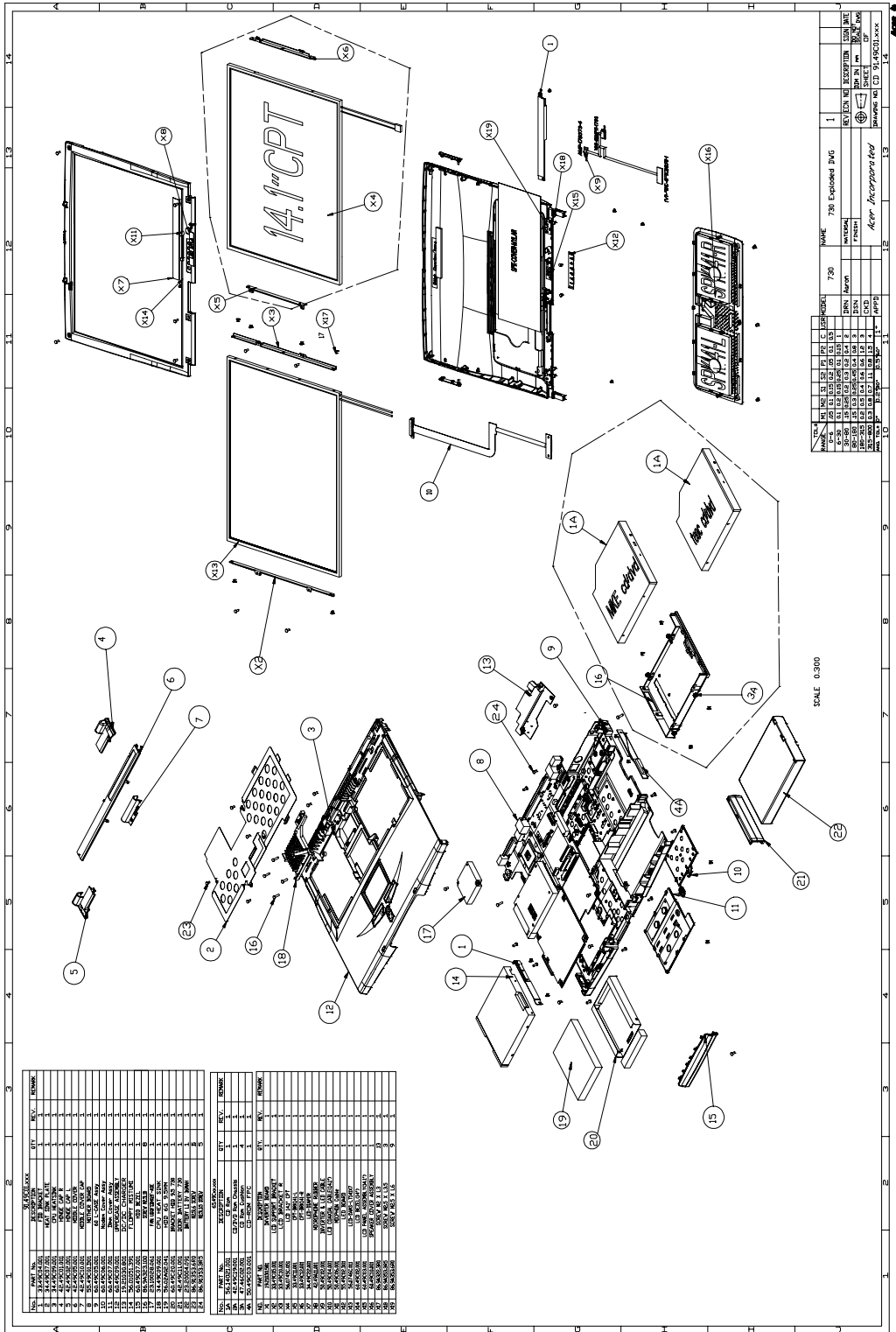

REV.	DATE	BY	CHK.	REMARKS
1				
2				
3				
4				
5				
6				
7				
8				
9				
10				
11				
12				
13				
14				
15				
16				
17				
18				
19				
20				
21				
22				
23				
24				



REV.	DATE	BY	CHK.	REMARKS
1				
2				
3				
4				
5				
6				
7				
8				
9				
10				
11				
12				
13				
14				
15				
16				
17				
18				
19				
20				
21				
22				
23				
24				

REV.	DATE	BY	CHK.	REMARKS
1				
2				
3				
4				
5				
6				
7				
8				
9				
10				
11				
12				
13				
14				



NAME: 730 Electronic IMG
 DRAWN: [Signature]
 CHECKED: [Signature]
 APPROVED: [Signature]
 ACCT: [Signature]
 REVISED BY: [Signature]
 REVISED DATE: [Date]
 DRAWING NO.: [Number]
 SHEET NO.: [Number]
 SHEETS: [Number]
 ISSUE NO.: [Number]
 ISSUE DATE: [Date]

Picture	No.	Partname	Description	Part No.
Processor				
	NS	CPU 450 MHz INTEL	IC CPU COPPERM-450 1.3V UPGA2	01.COPRM.450
	NS	CPU 500 MHz INTEL	IC CPU COPPERM-500 W/GEYS BGA2	01.COPRM.50A
	NS	CPU 600 MHz INTEL	IC CPU COPP600 W/GEY UPGA2	01.COPRM.60C
Memory				
	NS	DIMM 64MB SDRAM/ Mitsubishi	SDIMM 64M HYS64V8220GCDL- 8(SIE)	72.64820.B0N
	NS	DIMM 64MB SDRAM/ SAMSUNG	SODIMM 64M 4*16 MH8S64BS-8TA	72.08S64.C0N
	NS	DIMM 64MB SRRAM/ WINBOND	SODIMM 64M W9864CASB- 75(WINBON)	72.W9864.00N
	NS	DIMM 128MB SDRAM/ Mitsubishi	SODIMM 128M MH16S64VS-8TA(MIT)	72.16S64.A0N
PCB				
	8	TM730 MAINBOARD	730 MAIN BOARD	55.49C01.001
	13	DC-DC CHARGER BOARD TM730	DC-DC CHARG T62.136.C.00 730	19.21030.801
	NS	TOUCHPAD BOARD	TOUCHPAD MULTI- SWITCH SYNAPTIC	56.1740C.001
	NS	PCI MODEM BOARD	MODEM 56K AMBIT/ J07.017.C.00	54.09011.211





Picture	No.	Partname	Description	Part No.
	NS	PCI MODEM/LAN COMBO BOARD	MDM/LAN 56K AMBIT/T60.082.C.00	54.09051.001
LCD				
	NS	LCD ASSEMBLY MODULE(14.1") IBM	ASSY LCD 14.1" 730/IBM	6M.49C01.021
	NS	LCD 14.1" TFT IBM	LCD 14.1" IBM/ITXG76	56.0749C.001
	X12	LED BOARD 730	730 LED BOARD	55.49C02.001
	NS	INVERTER AMBIT	INVERTER T621124.00730	19.21030.941
	X9	INVERTER TO LED CABLE	C.A LED INVERTER COAXIAL 730	50.49C02.001
	X10	LCD FPC CABLE	C.A LCD COAXIAL 730	50.49C04.001

Picture	No.	Partname	Description	Part No.
	NS	SPEAKER TO LED CABLE	W.A 4/4P 50MM SPK&LED 730	50.49C07.011
	X11	MIC CABLE	W.A 2P/MIC 40MM 730	50.49C06.001
	NS	HINGE PACK	ASSY HINGE PACK 730	6K.49C01.011
	NS	LCD BRACKET L	BRKT LCD SUPPORT(L)SUS 730	33.49C10.001
	NS	LCD BRACKET R	BRACK LCD SUPPORT SECC 730	33.49C05.001
	NS	LCD PANEL	ASSY LCD PNL 14.1" 730	60.49C04.001
	X14	LCD BEZEL	ASSY LCD BZL 14.1" 730	60.49C02.001

Picture	No.	Partname	Description	Part No.
	X16	SPEAKER ASSEMBLY MODULE	ASSY SPEAKER COVER 730	60.49C10.001
	NS	LCD ASSEMBLY MODULE(13.3") ADT	ASSY LCD MODULE 13.3" 730/ADT	6M.49C01.051
	NS	LCD 13.3 TFT ADT	LCD 13.3"XGA TFT ADT/ L133X2	56.0742F.001
	X12	LED BOARD 730	730 LED BOARD	55.49C02.001
	NS	INVERTER AMBIT	INVERTER T621124.00 730	19.21030.941
	NS	INVERTER TO LED CABLE	C.A LCD 13.0, 13.3 INVER	50.41C10.001
	NS	LCD FPC CABLE	C.A LCD 13.3 LG 520	50.41C11.001

Picture	No.	Partname	Description	Part No.
	NS	MIC CABLE	MICROPHONE WM-60A W/CAB	23.42007.071
	NS	HINGE PACK	ASSY HINGE PACK 730	6K.49C01.001
	NS	LCD BRACKET L	BRKT LCD L 13.3"LG SECC 520	33.41C08.001
	NS	LCD BRACKET R	BRKT LCD-R 13.3 SECC 520	33.41C10.001
	NS	LCD PANEL	ASSY LCD PNL 13.3" LG ADT 520	60.41C04.051
	NS	LCD BEZEL	ASSY LCD BZL 13.3"LG ADT 520	60.41C03.041
	X16	SPEAKER ASSEMBLY MODULE	ASSY SPEAKER COVER 730	60.49C10.001

Picture	No.	Partname	Description	Part No.
	NS	LCD ASSEMBLY MODULE(14.1")	ASSY LCD MODULE 14.1" 730/CPT	6M.49C01.031
	NS	LCD 14.1" TFT CPT	LCD 14.1 LVDS CPT/ CLAA141*B01	56.0745C.051
	X12	LED BOARD 730	730 LED BOARD	55.49C02.001
	NS	INVERTER AMBIT	INVERTER T621124.00 730	19.21030.941
	X9	INVERTER TO LED CABLE	C.A LED INVERTER COAXIAL 730	50.49C02.001
	X10	LCD FPC CABLE	C.A LCD COAXIAL 730	50.49C04.001
	NS	SPEAKER TO LED CABLE	W.A 4/4P 50MM SPK&LED 730	50.49C07.011

Picture	No.	Partname	Description	Part No.
	X11	MIC CABLE	W.A 2P/MIC 40MM 730	50.49C06.001
	NS	HINGE PACK	ASSY HINGE PACK 730	6K.49C01.011
	X6	LCD BRACKET R	BRKT -R (CPT) SUS 730	33.49C12.001
	X5	LCD BRACKET L	BRKT -L (CPT) SUS 730	33.49C11.001
	NS	LCD PANEL	ASSY LCD PNL 14.1" 730	60.49C04.001
	X14	LCD BEZEL	ASSY LCD BZL 14.1" 730	60.49C02.001
	X16	SPEAKER ASSEMBLY MODULE	ASSY SPEAKER COVER 730	60.49C10.001



Picture	No.	Partname	Description	Part No.
	NS	LCD ASSEMBLY MODULE(15") HITACHI	ASSY LCD MODULE 15" 730 FP	6M.49C01.061
	NS	LCD 15" TFT HITACHI	LCD 15TFT HITACH/ TX38D85VC1CAA	56.0749C.031
	X12	LED BOARD 730	730 LED BOARD	55.49C02.001
	NS	INVERTER AMBIT	INVERTER T621124.00 730	19.21030.941
	X9	INVERTER TO LED CABLE	C.A LED INVERTER COAXIAL 730	50.49C02.001
	NS	LCD FPC CABLE	C.A LCD COAXIAL 730	50.49C04.011
	NS	SPEAKER TO LED CABLE	W.A 4/4P 50MM SPK&LED 730	50.49C07.011



Picture	No.	Partname	Description	Part No.
	X11	MIC CABLE	W.A 2P/MIC 40MM 730	50.49C06.001
	NS	HINGE PACK	ASSY HINGE PACK 730	6K.49C01.021
	NS	LCD PANEL	LCD PNL ASSY 15" 730 FP	60.49C04.021
	NS	LCD BEZEL	ASSYLCDBZL 15" 730	60.49C02.011
	X16	SPEAKER ASSEMBLY MODULE	ASSY SPEAKER COVER 730	60.49C10.001
HDD				
	NS	HDD ASSEMBLY 6G IBM	ASSY 6GB 9.5 HDD MODULE IBM	6M.49C05.001
	NS	HDD ASSEMBLY 9G IBM	ASSY 9GB 9.5 HDD MODULE IBM	6M.49C05.011
	NS	HDD ASSEMBLY 18G IBM	ASSY 18GB 12.7 HDD MODULE IBM	6M.49C05.041
	NS	HDD CONNECTOR	CONN EDGE 44P 20126S-44G5	20.50069.044





Picture	No.	Partname	Description	Part No.
FDD				
	14	FDD 1.44M MITSUMI	FDD 1.44M MITSUMI/ D353G	56.01051.391
CD-ROM				
	NS	CDROM ASSEMBLY MODULE 24X	ASSY CD ROM MODULE 730	6M.49C02.001
	NS	CHASSIS AND PLATE CDROM	ASSY DVD-ROM 730	60.49C03.001
	4A	CDROM FPC CABLE	C.AFPCD-ROM 730	50.49C03.001
	NS	CDROM 24X MKE	CD DRV SLIM MKE/CR- 176 24X	56.10241.001
DVD-ROM				
	NS	DVD-ROM ASSEMBLY MODULE 6X	ASSY DVD MODULE 730	6M.49C03.011

Picture	No.	Partname	Description	Part No.
	4A	CDROM FPC CABLE	C.A FPC CD-ROM 730	50.49C03.001
	NS	CHASSIS AND PLATE CDROM	ASSY DVD-ROM 730	60.49C03.001
	NS	DVD-ROM 6X TOSHIBA	DVD ROM 6X 12.7MM TOSH/SDC2302	56.2242C.001
Mechanical Parts				
	9	LOWER CASE	ASSY LOW CASE BCG955 730	60.49C05.001
	NS	UPPER CASE + T/P	U-CASE ASSY W T/P & CABLE 730	60.49C09.021
	11	LOWER DIMM COVER	ASSY DIMM CVR BCG955 730	60.49C07.001
	10	MODEM COVER	ASSY MODEM CVR BCG955 730	60.49C06.001

Picture	No.	Partname	Description	Part No.
	6	MIDDLE COVER	CVR MIDDLE KU2-1518 730	42.49C05.001
	7	MIDDLE HINGE CAP	CVR CAP MIDDLE PC 730	42.49C10.001
	3	CPU HEATSINK	HEATSINK CPU AL 730	34.49C09.001
	2	HEATSINK PLATE	HSINK PLT AL 730	34.49C07.001
	17	FAN	FAN 44.5*44.5 UDQFSDH02F-ASE	23.10028.061
	NS	AUDIO JACK HOLDER	HLD AUDIO JACK ABS 730	41.49C03.001
	1	FDD BRACKET	BRKT FDD SECC 730	33.49C04.001

Picture	No.	Partname	Description	Part No.
Touchpad				
	NS	TOUCHPAD FRAME	FRAME TOUCHPAD NYLON66 730	42.49C03.001
	NS	TOUCHPAD LOWER BUTTON	BUTTON TOUCHPAD ABS 730	42.49C04.001
	NS	TOUCHPAD R+L BUTTON	BUTTON TOUCHPAD 2 ABS 730	42.49C22.001

Picture	No.	Partname	Description	Part No.
Keyboard				
	NS	KEYBOARD/US DARFON	NKS-84X01 US	90.49C07.001
	NS	KEYBOARD/SWISS/ FRE/GER DARFON		91.63X07.000
	NS	KEYBOARD/THAI DARFON		91.63X07.003
	NS	KEYBOARD/ARABIC/US DARFON		91.63X07.004
	NS	KEYBOARD/CZECH DARFON		91.63X07.009
	NS	KEYBOARD/ARABIC/ SAKHA DARFON		91.63X07.00A
	NS	KEYBOARD/BELGIUM DARFON		91.63X07.00B
	NS	KEYBOARD/CHINESE DARFON		91.63X07.00C
	NS	KEYBOARD/DENMARK DARFON		91.63X07.00D
	NS	KEYBOARD/ITALIAN DARFON		91.63X07.00E
	NS	KEYBOARD/FRENCH DARFON		91.63X07.00F
	NS	KEYBOARD/GERMAN DARFON		91.63X07.00G
	NS	KEYBOARD/HEBREW DARFON		91.63X07.00H
	NS	KEYBOARD/JAPANESE DARFON		91.63X07.00J
	NS	KEYBOARD/KOREAN DARFON		91.63X07.00K
	NS	KEYBOARD/ NORWEGIAN DARFON		91.63X07.00N
	NS	KEYBOARD/ PORTUGAL DARFON		91.63X07.00P
	NS	KEYBOARD/RUSSIAN DARFON		91.63X07.00R
	NS	KEYBOARD/SPANISH DARFON		91.63X07.00S
	NS	KEYBOARD/TURKEY DARFON		91.63X07.00T
NS	KEYBOARD/UK DARFON		91.63X07.00U	
NS	KEYBOARD/SWEDEN DARFON		91.63X07.00W	
Cable				
	NS	TOUCH PAD CABLE	C.A FPC TOUCH PAD 730	50.49C01.001

Picture	No.	Partname	Description	Part No.
	NS	NETWORK CABLE	W.A 2/2P MODEM 185MM NAGANO-1	50.46C11.001
	NS	FDD FPC CABLE	C.A FPC FDD 730	50.49C05.011
Power				
	NS	ADAPTER 60W/DELTA	ADT 60W ADP-60XB D 3P 730/340	25.10064.041
	NS	ADAPTER 60W/LITEON	ADT 60W PA-1600-19 720	25.10068.031
	NS	BATTERY PACK	ASSY BTY PACK BTP- 30A1 730	60.49C01.001
	NS	POWER CORD	CORD 125V UL 3P K01081B1183WP	27.01618.051
Miscellaneous				
	NS	730 LOGO	PLATE NAME(LOGO) PC AN390	40.43A02.001
	NS	730 NAME PLATE	Name Plate for 730TLV	40.49C12.001
	NS	LCD RUBBER TM730	CSN SCRW SILICON 050 6*3H 800	47.49A02.001
	NS	FOOT RUBBER TM730	FOOT RUBBER 000 NAGANO-1	47.46C01.001
	NS	CAMERA RUBBER TM730	RUBBER CAMERA SILICON 520	47.41C04.001

Picture	No.	Partname	Description	Part No.
	NS	MIC RUBBER TM730	RUBBER MICROPHONE 730	47.49C10.001
	NS	LCD LATCH TM730	LATCH LCD NYLON66 730	42.49C07.001
	NS	LCD LATCH SPRING TM730	SPRING EJ-KNOB SWP 300	34.47604.001
	NS	SPEAKER SCREW MYLAR	MYLAR SPK CVR SCRW 730	40.49C08.001
	NS	HINGE SCREW MYLAR	MYLAR FOR HINGE PC 390	40.43A01.081
Screws				
	X17		SCRW BIND M2*L3 B-ZN SHIVA	86.9A322.3R0
	X18		SCRW WAFER MYLO M2.5*3.5L B-ZN	86.9A353.3R5
	X19		SCRW WAFER NYLO M2.5*6L B-ZN	86.9A353.6R0
	NS		SCRW MACH PAN M2*10L NI	86.1A522.100
	NS		SCRW BINDING BL-ZN M2.5*L10	86.9A323.100
	NS		SCREW MECH RWH M2*4L NI	86.6A522.4R0
Others				
	NS	RTC BATTERY	BTY LI 3V CR1220 36MAH	23.20004.091

Model Definition and Configuration

This appendix provides the BASIC model number and the configuration to TravelMate 730 decided for Acer's "global" product offering. Contact your regional offices or the responsible personnel/channel to provide you with further extension model numbers and configurations.

- Trade Mark: Acer
- Brand Name: Acer
- Product Name: TravelMate 730
- Description: Notebook Personal Computer

Model Number Definitions

Model No.	LCD	CPU	Memory	HDD	Ext. Module	BTY
730TX	14.1" TFT	PIII-450	64MB	12GB	HDD 24X CD-ROM	Lilon
731TL	15.0" TFT	PIII-500	128MB	18GB	HDD 24X CD-ROM	Lilon
731TLV	15.0" TFT	PIII-500	128MB	18GB	HDD 2X DVD	Lilon

Test Compatible Components

This computer's compatibility is tested and verified by Acer's internal testing department. All of its system functions are tested under Windows 95, Windows 98, Windows 2000 and Windows NT environment.

Refer to the following lists for components, adapter cards, and peripherals which have passed these tests. Regarding configuration, combination and test procedures, please refer to the TravelMate 730 Compatibility Test Report released by the Acer Mobile System Testing Department.

Windows 95 Environment Test

Item	Specifications
Processor	Intel Pentium III 450 Intel Pentium III 500
Memory	64MB SDRAM 128MB SDRAM
LCD	13.3 TFT LCD 14.1 TFT LCD 15 TFT LCD
Hard Disk	IBM 6GB IBM 9GB IBM 12GB IBM 15GB IBM 18GB
CD-ROM	24x CD-ROM
FDD	Mitsumi 3.5" FDD (support 3 mode)
Battery	Sony Li-Ion battery
Adapter	Delta adapter 60XBD
FIR	IBM

Windows 98 Environment Test

Item	Specifications
Processor	Intel Pentium III 450 Intel Pentium III 500
Memory	32MB SDRAM 64MB SDRAM 128MB SDRAM
LCD	13.3 TFT LCD 14.1 TFT LCD 15 TFT LCD
Hard Disk	IBM 6GB IBM 9GB IBM 12GB IBM 15GB IBM 18GB
CD-ROM	24x CD-ROM
FDD	Mitsumi 3.5" FDD (support 3 mode)
Battery	Sony Li-Ion battery
Adapter	Delta adapter 60XBD
FIR	IBM

Windows 2000 Environment Test

Item	Specifications
Processor	Intel Pentium III 450 Intel Pentium III 500
Memory	32MB SDRAM 64MB SDRAM 128MB SDRAM
LCD	13.3 TFT LCD 14.1 TFT LCD 15 TFT LCD
Hard Disk	IBM 6GB IBM 9GB IBM 12GB IBM 15GB IBM 18GB
CD/DVD ROM	24x CD-ROM 6x DVD ROM
FDD	Mitsumi 3.5" FDD (support 3 mode)
Battery	Sony Li-Ion battery
Adapter	Delta adapter 60XBD
FIR	IBM

Windows NT Environment Test

Item	Specifications
Processor	Intel Pentium III 450 Intel Pentium III 500
Memory	64MB SDRAM 128MB SDRAM
LCD	13.3 TFT LCD 14.1 TFT LCD 15 TFT LCD
Hard Disk	IBM 6GB IBM 9GB IBM 12GB IBM 15GB IBM 18GB
CD-ROM	24x CD-ROM
FDD	Mitsumi 3.5" FDD (support 3 mode)
Battery	Sony Li-Ion battery
Adapter	Delta adapter 60XBD
FIR	IBM

Online Support Information

This section describes online technical support services available to help you repair your Acer Systems.

If you are a distributor, dealer, ASP or TPM, please refer your technical queries to your local Acer branch office. Acer Branch Offices and Regional Business Units may access our website. However some information sources will require a user i.d. and password. These can be obtained directly from Acer CSD Taiwan.

Acer's Website offers you convenient and valuable support resources whenever you need them.

In the Technical Information section you can download information on all of Acer's Notebook, Desktop and Server models including:

- Service guides for all models
- User's manuals
- Training materials
- Main manuals
- Bios updates
- Software utilities
- Schematics
- Spare parts lists
- Chips
- TABs (Technical Announcement Bulletin)

The service repair section provides you with downloadable information on:

- Troubleshooting guides
- Tooling box information
- Repair instructions for specific models
- Basic repair guidelines
- Debug cards for Acer's latest models

For these purposes, we have included an Acrobat File to facilitate the problem-free downloading of our technical material.

Also contained on this website are:

- Detailed information on Acer's International Traveler's Warranty (ITW)
- Returned material authorization procedures
- An overview of all the support services we offer, accompanied by a list of telephone, fax and email contacts for all your technical queries.

We are always looking for ways to optimize and improve our services, so if you have any suggestions or comments, please do not hesitate to communicate these to us.

A

- AC Adapter 19
- ACPI 1.0a 12
- Ambit 13
- APM 1.2 12
- Audio 12, 15
- Audio Jack Cover
 - Removing 52

B

- Battery 18
- Battery Pack 41
- battery pack
- charging indicator 10
- BIOS 12
 - package 12
 - password control 12
 - ROM size 12
 - ROM type 12
 - vendor 12
 - Version 12
- BIOS Supports protocol 12
- BIOS Utility 23–30
 - Basic System Settings 25
 - Load Default Settings 30
 - navigating 23
 - Onboard Devices Configuration sub-menu 27
 - Startup Configuration 26
 - System Information 24
 - System Security 28
- Board Layout 4
 - Bottom View 5
 - Top View 4
- brightness
 - hotkeys 11

C

- Cache
 - controller 12
 - size 12
- caps lock
 - on indicator 10
- CardBus 17

- CD-ROM Interface 14
- Chipsets 12
- Compatibility Test 95
- computer
 - on indicator 10
- contrast
 - hotkeys 11
- Controllers 12
- Core logic 12
- CPU
 - core voltage 12
 - I/O voltage 12
 - package 12
 - Removing 49
 - type 12

D

- date
 - setting in Setup Utility 25
- DC-DC Charger Board
 - Removing 51
- Design 1
- Diagnostics
 - PQA 34
- DIMM 12
 - Combinations 13
 - external 42
 - package 13
 - removing 42
 - Speed 13
 - voltage 13
- Disassembly
 - Battery Pack 41
 - CD-ROM/DVD-ROM Module 44
 - Floppy Disk Drive 46
 - Hard Disk Drive 45
 - LCD Module 48
 - Machine 37
 - Procedure Flowchart 39
- Diskette
 - System Diagnostics 33
 - System Utility 32
- Display 2
- display
 - hotkeys 11
- Display Standby Mode 20

DMA Channel Assignment 22
DVD-ROM Interface 15

E

Environmental Requirements 20
Error Symptom-to-Spare Part Index 61
External CD-ROM Drive Check 58
External Diskette Drive Check 58

F

Fan
 Removing 51
Fan Utility 32
Features 1
FIR 17
Floppy Disk
 removing the 46
Floppy Disk Drive Interface 14
FRU (Field Replaceable Unit) List 75

H

Hard disk 12, 14
 removing the 45
Hard Disk Standby Mode 20
Hardware Specifications and Configurations 12
HDD 12, 14
Hibernation Mode 20
Hibernation mode
 hotkey 11
Hinge
 Removing 56
Hot Keys 11

I

I/O Address Map 21
Indicators 10
infrared
 setting in BIOS Utility 27
Intermittent Problems 67
Inverter Board
 Removing 54
IrDA 17
IRQ Assignment Map 22

J

Jumper and Connector Locations 71
 Top View 71

K

Keyboard 12, 17
 Removing 47
Keyboard or Auxiliary Input Device Check 58

L

L2 cache 12
LAN/Modem Combo 13
LCD 18
 DC-AC LCD Inverter 18
LCD Bezel
 Removing 53
LCD Bracket
 Removing 54
LED Board
 Removing 55

M

Machine Disassembly 37
Main Board Data Utility 32
Mechanical Specification 20
media access
 on indicator 10
Memory
 Address Map 21
Memory Address Map 21
Memory Check 59
Microphone
 Removing 55
Model Number and Configurations 93
Modem 13
Modem Combo Card
 external 43
Modem Power Cable
 Removing 52

N

Notebook Manager
 hotkey 11
num lock
 on indicator 10

O

Online Support Information 101

P

Panel 6

- Bottom 8
- left 6
- Rear 7
- right 9
- Panel ID Utility 32
- Parallel Port 16
- parallel port
 - setting in BIOS Utility 28
- password
 - changing in Setup Utility 30
- PC Card 10, 12, 17
- PCMCIA 17
- PCMCIA Socket
 - Removing 52
- Pentium III 12
- Power Management 19
- Power management 2
- Power System Check 59
 - Battery Pack 60
 - Power Adapter 59
- PQA
 - diagnostics 34
- PQA Diagnostics Program 34
- Processor 12, 96

R

- RTC 12
 - Removing 50

S

- Screw List 40
- Second Level Cache 12
- Serial Port 17
- serial port
 - setting in BIOS Utility 27
- Speaker Assembly Module
 - Removing 53
- speakers
 - hotkey 11
- Standby Mode 19

- Super I/O 12
- System
 - Block Diagram 3
 - Diagnostic Diskette 33
 - Layout 4
 - Utility Diskette 32
- System Board
 - Removing 52
- System Check Procedures 58
- System Memory 12

T

- Temperature 20
- Test Compatible Components 95
- Thermal Utility 32
- time
 - setting in Setup Utility 25
- touchpad
 - hotkey 11
- Touchpad Check 60
- TouchPad Module
 - Removing 48
- Troubleshooting 57

U

- Undetermined Problems 68
- USB 17
- utility
 - BIOS 23–30

V

- Video 16
 - Resolutions 16
- Video controller 12

W

- Windows 2000 Environment Test 98
- Windows 95 Environment Test 96
- Windows 98 Environment Test 97
- Windows NT Environment Test 99

