

Travel Mate 720

Service Guide

Service guide files and updates are available on the AIPG/CSD web; for more information, please refer to <http://csd.acer.com.tw>

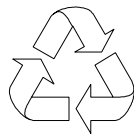

100% Recycled Paper

PART NO.: 49.42C01.001
DOC. NO.: SG295-9803A

PRINTED IN TAIWAN

Copyright

Copyright © 1999 by Acer Incorporated. All rights reserved. No part of this publication may be reproduced, transmitted, transcribed, stored in a retrieval system, or translated into any language or computer language, in any form or by any means, electronic, mechanical, magnetic, optical, chemical, manual or otherwise, without the prior written permission of Acer Incorporated.

Disclaimer

The information in this guide is subject to change without notice.

Acer Incorporated makes no representations or warranties, either expressed or implied, with respect to the contents hereof and specifically disclaims any warranties of merchantability or fitness for any particular purpose. Any Acer Incorporated software described in this manual is sold or licensed "as is".

Should the programs prove defective following their purchase, the buyer (and not Acer Incorporated, its distributor, or its dealer) assumes the entire cost of all necessary servicing, repair, and any incidental or consequential damages resulting from any defect in the software.

Acer is a registered trademark of Acer Corporation.

Intel is a registered trademark of Intel Corporation.

Pentium and Pentium II are trademarks of Intel Corporation.

Other brand and product names are trademarks and/or registered trademarks of their respective holders.

Conventions

The following conventions are used in this manual:

Screen messages	Denotes actual messages that appear on-screen.
NOTE	Gives bits and pieces of additional information related to the current topic.
WARNING	Alerts you to any damage that might result from doing or not doing specific actions.
CAUTION	Gives precautionary measures to avoid possible hardware or software problems.
IMPORTANT	Reminds you to do specific actions relevant to the accomplishment of procedures.

Preface

Before using this information and the product it supports, please read the following general information!

- 1 This Service Guide provides you with all technical information relating to the BASIC CONFIGURATION decided for Acer's "global" product offering. To better fit local market requirements and enhance product competitiveness, your regional office MAY have decided to extend the functionality of a machine (e.g. add-on card, modem, or extra memory capability). These LOCALIZED FEATURES will NOT be covered in this generic service guide. In such cases, please contact your regional offices or the responsible personnel/channel to provide you with further technical details.
- 2 Please note WHEN ORDERING FRU PARTS, that you should check the most up-to-date information available on your regional web or channel. If, for whatever reason, a part number change is made, it will not be noted in the printed Service Guide. For ACER-AUTHORIZED SERVICE PROVIDERS, your Acer office may have a DIFFERENT part number code to those given in the FRU list of this printed Service Guide. You MUST use the list provided by your regional Acer office to order FRU parts for repair and service of customer machines.

Table of Contents

Chapter 1 System Specifications

Major Features	1
System	1
Connectivity	1
Display	2
Video Performance	2
Simultaneous Display	2
Dual Display	2
Power Management	2
Opening and Closing the Display	3
Indicators	4
Keyboard	5
Special Keys	5
I/O Ports	10
Rear Ports	10
Right Ports	12
Bottom Port	13
Hardware Configuration and Specifications	14
Power Management	27
Power Management Modes	27
Advanced Power Management	30
Advanced Configuration and Power Interface	30

Chapter 2 System Utilities

PhDISK	32
Syntax	32
Notebook Manager	33
Information Viewer	34
Boot Sequence	35
Password	36
Power Management	38
Display Device	39
Line-in/Microphone	40
Setup Utility	41
Navigating the Setup Utility	41
Main	42
Advanced	47
Security	48

Table of Contents

Power	51
Exit	53

Chapter 3 Removal and Replacement

External Module Replacement	57
Reassembling the Modem Board	57
Installing Memory	57
Disassembling the CD-ROM Drive	58
Removing the Hard Disk Drive	59
Disassembling the Hard Disk Drive	59
Removing and Replacing the Battery Pack ..	60
Removing the Keyboard	62
Removing the LCD	65
Removing the CPU	68
Disassembling the Upper Case	70
Removing the Speakers	72
Removing the Touchpad Bracket	73
Disassembling the Lower Case	74
Removing the Floppy Disk Drive	74
Disassembling the Fan	75
Removing the System Board	76
Removing the IDE Board	77
Removing the PCMCIA Card	77
Disassembling the LCD	78

Chapter 4 Troubleshooting

Diskette Drive Checkout	83
CD-ROM Driver Test	83
Keyboard or Auxiliary Input Device Checkout	84
Memory Checkout	85
Power System Checkout	86
TouchPad Checkout	88
Symptom-to-FRU Index	89
Numeric Error Codes	89
Intermittent Problems	95
Undetermined Problems	96
Utility Program Diskette	97
Setting LCD Panel ID	97

Table of Contents

Setting Thermal Sensor Utility	97
Running the Diagnostics	98

Chapter 5 Jumper and Connector Information

Top View	103
Bottom View	104

Chapter 6 FRU (Field Replaceable Unit) List

Appendix A Model Definition and Configuration

Appendix B Test Compatible Components List

PCMCIA	124
PCMCIA Cards Tested for Year2000 Compliance	125
Long Run	126
Year2000 Compliance Test	126

Appendix C Online Support Information

Index

Table of Contents

System Specifications

Major Features

System

- Intel Pentium® II processor
- 64-bit main memory and on-die¹ L2 cache memory
- Large and vibrant Thin-Film-Transistor (TFT) Extended Graphics Array (XGA) Liquid Crystal Display (LCD)
- 256-bit PCI/AGP graphics acceleration with 2.5MB graphics memory
- Internal, Ultra-slim, high-speed and removable CD-ROM drive (AcerMedia Bay)
- Internal 3.5-inch floppy drive
- High-capacity, Enhanced-IDE removable hard disk
- Lithium-Ion battery pack
- Power management system
- 16-bit high-fidelity PCI stereo audio with 3-D sound and wavetable synthesizer
- Built-in dual speakers and echo-cancelling microphone
- S-video output
- Dual display capability

Connectivity

- High-speed fax/data PCI modem
- Fast infrared(FIR) wireless communication
- Universal Serial Bus (USB) port
- Sleek, smooth and stylish design
- Full-sized keyboard
- Wide and curved palm rest
- Ergonomically-centered touchpad pointing device
- CardBus PC Card (formerly PCMCIA) slots (two type II/I or one type III) with Zoomed Video (ZV) support
- DockMate V mini docking station option for one-step connection and disconnection of peripherals
- Upgradeable memory and hard disk

¹ "on-die" means "on chip"

Display

The large graphics display offers excellent viewing, display quality and desktop performance graphics. The computer supports a Thin-Film Transistor (TFT) liquid crystal display (LCD) displaying 16-bit hi-color at 1024x768 Extended Graphics Array (XGA) resolution.

Video Performance

PCI local bus video with industry-leading 256-bit graphics acceleration and high-speed 2.5MB Synchronous Graphics Random Access Memory (SGRAM) boost video performance.

Simultaneous Display

The computer's large display and multimedia capabilities are great for giving presentations. If you prefer, you can also connect an external monitor when giving presentations. This computer supports simultaneous LCD and CRT display. Simultaneous display allows you to control the presentation from your computer and at the same time face your audience. With the built-in S-video output jack, you can even connect other output display devices such as LCD projection panels for large-audience presentations.

Dual Display

The computer's unique graphics chip takes advantage of Windows 98's multi-display capability, allowing you to extend your desktop to an external display device, such as an external monitor or projector. With this feature enabled, you can move program windows to/from the computer LCD and the external monitor.

Power Management

The power management system incorporates an "automatic LCD dim" feature that automatically decides the best settings for your display and at the same time conserves power.

Opening and Closing the Display

To open the display, slide the display cover latch to the left and lift up the cover. Then tilt it to a comfortable viewing position. The computer employs a microswitch that turns off the display (and enters standby mode) to conserve power when you close the display cover, and turns it back on when you open the display cover.

Note: If an external monitor is connected, the computer turns off the display (but does not enter standby mode) when you close the display cover.

To close the display cover, fold it down gently until the display cover latch clicks into place.





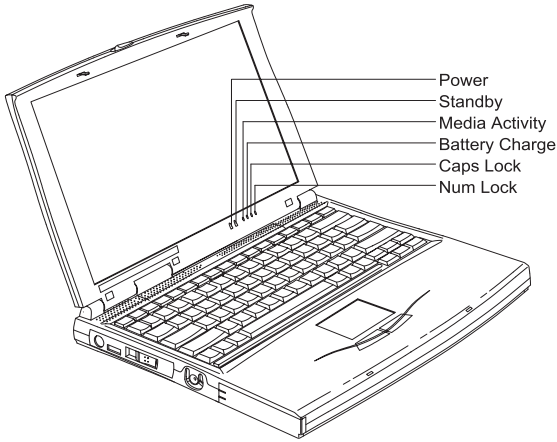

Warning: To avoid damaging the display, do not slam it when you close it. Also, do not place any object on top of the computer when the display is closed.

Indicators



The computer has six easy-to-read status indicators (LEDs) under the display screen.

The Power and Standby indicators are visible even when you close the display cover so you can see the status of the computer while the cover is closed.

Icon	Function	Description
	Power	Lights when the computer is on.
	Standby	Lights when the computer enters Standby mode.
	Media Activity	Lights when the floppy drive, hard disk or CD-ROM drive (or other AcerMedia Bay module) is active.
	Battery Charge	Lights when the battery is being charged.
	Caps Lock	Lights when Caps Lock is activated
	Num Lock	Lights when Numeric Lock is activated

Keyboard

The keyboard has full-sized keys and an embedded keypad, separate cursor keys, two Windows keys and twelve function keys.

Special Keys

Lock Keys

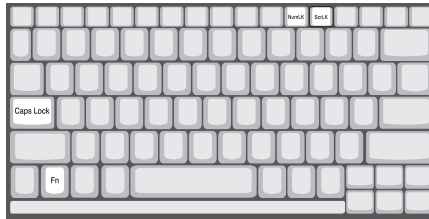

The keyboard has three lock keys which you can toggle on and off.

Lock Key	Description
Caps Lock	When Caps Lock is on, all alphabetic characters typed are in uppercase.
Num Lock (Fn-F11)	When Num Lock is on, the embedded keypad is in numeric mode. The keys function as a calculator (complete with the arithmetic operators +, -, *, and /). Use this mode when you need to do a lot of numeric data entry. A better solution would be to connect an external keypad.
Scroll Lock (Fn-F12)	When Scroll Lock is on, the screen moves one line up or down when you press \uparrow or \downarrow respectively. Scroll Lock does not work with some applications.

Embedded Numeric Keypad



- ❑ The embedded numeric keypad functions like a desktop numeric keypad. It is indicated by small characters located on the upper right corner of the keycaps. To simplify the keyboard legend, cursor-control key symbols are not printed on the keys.

Desired Access	Num Lock On	Num Lock Off
Number keys on embedded keypad	Type numbers in a normal manner.	
Cursor-control keys on embedded keypad	Hold Shift while using cursor-control keys.	Hold Fn while using cursor-control keys.
Main keyboard keys	Hold Fn while typing letters on embedded keypad.	Type the letters in a normal manner.

Note: If an external keyboard or keypad is connected to the computer, the Num Lock feature automatically shifts from the internal keyboard to the external keyboard or keypad.

Windows Keys

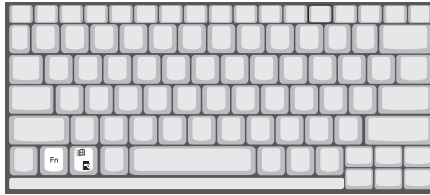

The keyboard has two keys that perform Windows-specific functions.



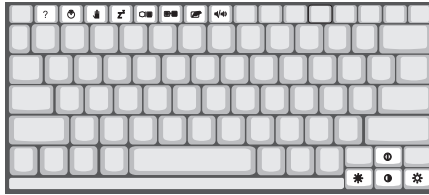

Key	Description
Windows logo key	Start button. Combinations with this key performs special functions. Below are a few examples: <ul style="list-style-type: none">Windows logo key + Tab (Activates next Taskbar button)Windows logo key + E (Explores My Computer)Windows logo key + F (Finds a Document)Windows logo key + M (Minimizes All)Shift + Windows logo key + M (Undoes Minimize All)Windows logo key + R (Displays the dialog box)
Application key	Opens the application's context menu (same as right-click).





Hot Keys



The computer employs hot keys or key combinations to access most of the computer's control like screen contrast and brightness, volume output and the BIOS setup utility.

To activate hot keys, press and hold the **Fn** key before pressing the other key in the hot key combination





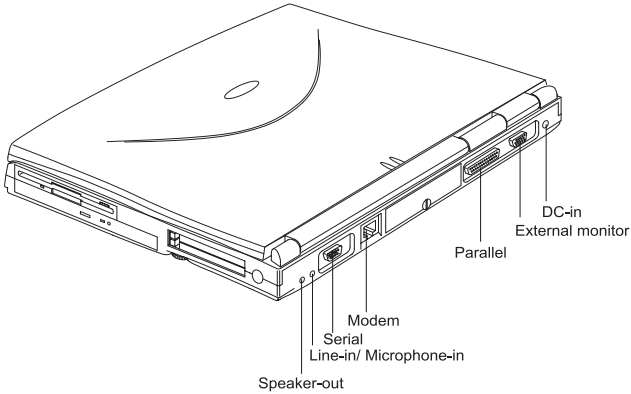

Hot Key	Icon	Function	Description
Fn+F1	?	Hot key help	Displays a list of the hotkeys and their functions.
Fn+F2		Setup	Accesses the notebook configuration utility.
Fn+F3		Standby	Puts the computer in Standby mode. Press any key to return.
Fn+F4	Z ^z	Hibernation	Puts the computer in Hibernation mode (if PHDISK, the hibernation utility, is installed, valid and enabled). Press the power switch to resume. Otherwise, the computer enters Standby mode. Note: If ACPI support is enabled, pressing this key puts the computer in sleep mode.
Fn+F5		Screen blank	Turns the display screen backlight off to save power. Press any key to return.
Fn+F6		Display toggle	Switches display output between the display screen, external monitor (if connected) and both the display screen and external monitor.

Hot Key	Icon	Function	Description
Fn+F7		Touchpad on/off	Turns the internal touchpad on and off.
Fn+F8		Speaker on/off	Turns the speakers on and off; mutes the sound.
Fn+→		Brightness up	Increases the screen brightness.
Fn+←		Brightness down	Decreases the screen brightness.

I/O Ports

Rear Ports



Icon	Port	Connects to...
	Speaker-out jack	Speakers or headphones
	Line-in/Microphone-in jack	Audio line-in device with a 3.5mm minijack (e.g., condenser microphone, audio CD player, stereo walkman).
	Serial port	Serial device (e.g., serial mouse)
	Modem jack	Phone line
	Parallel port	Parallel device (e.g., parallel printer)
	External monitor port	Display monitor (up to 1024x768 resolution, 64K-colors)

Icon	Port	Connects to...
	DC-in jack	AC adapter and power outlet

Fax/Data Modem



Some models have a built-in V.90 56Kbps PCI fax/data modem.

Note: This modem port is not compatible with digital phone lines. Plugging this modem into a digital phone line will damage the modem.

To use the fax/data modem port, connect a phone cable from the modem port to a telephone jack.

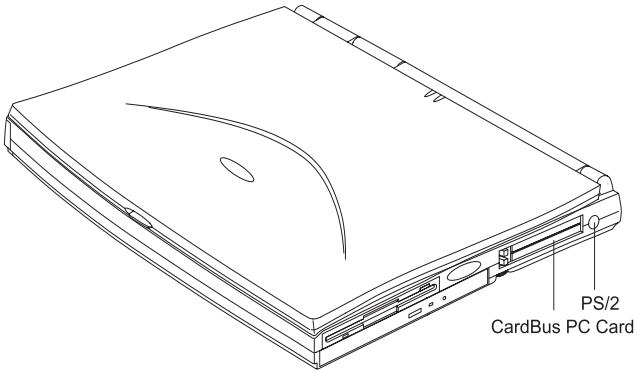
Right Ports



Icon	Port	Connects to...
	PC Card slots	16-bit PC Cards and 32-bit CardBus PC Cards (ZV- support)
	PS/2 port	PS/2-compatible device (e.g., PS/2 keyboard/mouse/keypad).

Bottom Port

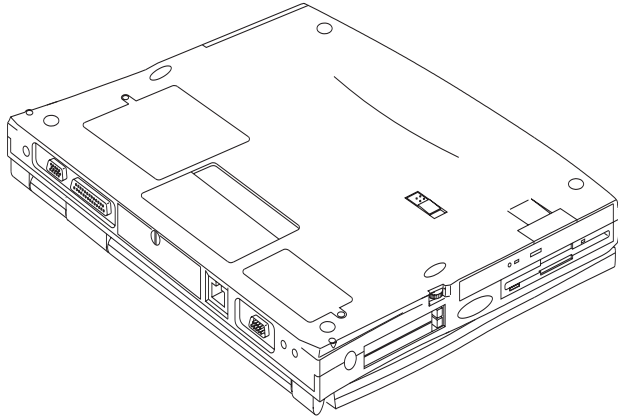

Icon	Port	Connects to...
	Mini docking connector	DockMate V mini docking station

Hardware Configuration and Specifications

Memory Address Map

Address Range	Definition	Function
000000-09FFFF	640 KB memory	Base memory
0A0000-0BFFFF	128 KB video RAM	Reserved
0C0000-0CBFFF	Video BIOS	Video BIOS
0F0000-0FFFFFF	64 KB system BIOS	System BIOS
100000-top limited	Extended memory	SIMM memory
FE0000-FFFFFF	256 KB system ROM	Duplicate of code assignment at 0E0000-0FFFFFF

Interrupt channel default assignment

Channel	Default setting	mode	Remarks
NMI	System errors		
IRQ0	System timer	Edge trigger	
IRQ1	Keyboard	Edge trigger	
IRQ2	(cascade)	Edge trigger	
IRQ3	Modem/COM1 (can be disable)	Edge trigger	Dynamically programmable
IRQ4	Infrared	Edge trigger	Dynamically programmable
IRQ5	SoundBlaster Audio (PCI device)	Level trigger	PCI interrupt sharing
IRQ6	Floppy	Edge trigger	
IRQ7	Printer	Edge trigger	Dynamically programmable
IRQ8	Real time clock	Edge trigger	
IRQ9	(SCI for ACPI OS) PCI device	Level trigger	PCI interrupt sharing
IRQ10	Modem	Edge trigger	Dynamically programmable
IRQ11	PCI device	Level trigger	PCI interrupt sharing
IRQ12	Pointing device	Edge trigger	
IRQ13	Math coprocessor	Edge trigger	
IRQ14	Hard disk driver		

Interrupt channel default assignment

Channel	Default setting	mode	Remarks
IRQ15	CD-ROM driver		

DMA channel default assignment

Channel	Default setting	Mode
DRQ/DACK0	Reserved	8-bit
DRQ/DACK1	ECP	8-bit
DRQ/DACK2	Floppy	8-bit
DRQ/DACK3	Fast Infrared	8-bit
DRQ/DACK5	Reserved	16-bit
DRQ/DACK6	Reserved	16-bit
DRQ/DACK7	Reserved	16-bit

I/O address map

Address	Device
000-00F	DMA controller-1
020-021	Interrupt controller-1
040-043	Timer 1
048-04B	Timer 2
060-06E	Keyboard controller 8742 chip select
070-071	Real-time clock and NMI mask
080-08F	DMA page register
0A0-0A1	Interrupt controller-2
0C0-0DF	DMA controller-2
1F0-1F7	Hard disk select
220-22F	Audio (option)
230-23F	Audio (option)
240-24F	Audio (option)
250-25F	Audio (option)
278-27F	Parallel port 3
2E8-2EF	COM4
2F8-2FF	COM2
378, 37A	Parallel port 2
3BC-3BE	Parallel port 1
3B4, 3B5, 3BA	Video subsystem
3C0-3C5	Video subsystem

I/O address map

Address	Device
3C6-3C9	Video DAC
3C0-3CF	Enhanced graphics adapter
3E0-3E1	PCMCIA controller
3E8-3EF	COM3
3F0-3F7	Floppy disk controller
3F8-3FF	COM1
CF8-Cff	PCI configuration register

Processor

Item	Specification
Processor type	Intel Dixson (300/333Mhz) MMC-2 module <ol style="list-style-type: none">1. Intel Pentium II architecture2. 16 KB instruction cache and 16 KB data cache with MMX Technology3. Quick Start for low power, low exit latency clock throttling"
Processor package	IMM module, 512KB L2 cache
Processor core voltage	1.8V
Processor I/O voltage	2.5V

BIOS

Item	Specification
BIOS vendor	Phoenix
BIOS Version	V1.0
BIOS ROM type	ROM
BIOS ROM size	256KB
BIOS package	32 PIn PLCC
Support protocol	PCI 2.1, APM 1.2, DMI 2.00.1, E-IDE, ACPI 1.0, ESCD 1.03, ANSI ATA 3.0, PnP 1.1a, Bootable CD-ROM 1.0, ATAPI
BIOS password control	RTC battery

System Memory

Item	Specification
Memory controller	MTXC
Onboard memory size	0MB
DIMM socket number	2 sockets (2 banks)

System Memory

Item	Specification
Supported memory size per DIMM	16/32/64/128 MB
Supported maximum memory size	256MB (128MB x 2)
Supported DIMM type	Synchronous DRAM
Supported DIMM Speed	SDRAM: With SPD without parity
Supported DIMM voltage	3.3V
Supported DIMM package	144-pin DIMM

DIMM Memory Combinations

Slot 1	Slot 2	Total Memory
16MB	0	16MB
0	16MB	16MB
0	32MB	32MB
0	64MB	64MB
16MB	16MB	32MB
16MB	32MB	48MB
16MB	64MB	80MB
16MB	128MB	144MB
32MB	32MB	64MB
32MB	64MB	96MB
32MB	128MB	160MB
64MB	64MB	128MB
64MB	128MB	192MB
128MB	128MB	256MB

Second-Level Cache

Item	Specification
Cache controller	MTXC
Tag RAM location	IMM
Tag RAM size	32K*8x1
Tag RAM voltage	3.3V
SRAM type	PBSRAM
SRAM size	256K/512K
SRAM location	IMM
SRAM configuration	32K*64 or 64K*32
SRAM speed	Cycle time = 7ns

Second-Level Cache

Item	Specification
SRAM voltage	3.3V
1st level cache control	always enabled
2st level cache control	always enabled
Cache scheme control	Fixed in Write-back

Video memory

Item	Specification
Fixed or upgradeable	Fixed, built-in NM2200 video controller
Memory size	2.5 MB

Video

item	Specification
Chip vendor	NeoMagic
Chip name	NM2200
Chip voltage	3.3 Volts
ZV port support (Y/N)	Yes
Graph interface (ISA/VESA/PCI)	PCI bus
Max. resolution (LCD)	1024x768 (64K colors) True Color
Max. resolution (Ext. CRT)	1024x768 (64K colors) True Color

External CRT Resolutions and Modes

Resolution	CRT Refresh Rate		Simultaneous on TFT LCD
	CRT only	LCD	
			SVGA
640x480x256	60,75,85	Y	Y
640x480x64K	60,75,85	Y	Y
640x480x16M	60,75,85	Y	Y
800x600x256	60,75,85	Y	Y
800X600X64K	60,75,85	Y	Y
800x600x16M	60,75,85	Y	Y
1024x768x256	60,70,75	Y	Y
1024X768X64K	60,70,75	Y	Y

Parallel Port

Item	Specification
Parallel port controller	NS PC97338

Parallel Port

Item	Specification
Number of parallel ports	1
Location	Rear side
Connector type	25-pin D-type
Parallel port function control	Enable/Disable by BIOS Setup
ECP support	Yes (set by BIOS setup)
Selectable ECP DMA channel (in BIOS Setup)	DMA channel 1 DMA channel 3
Selectable parallel port I/O address (via BIOS Setup)	3E8h, 2E8h, 378h, 278h, Disabled
Selectable parallel port IRQ (via BIOS Setup)	IRQ5, IRQ7

Serial Port

Item	Specification
Serial port controller	NS PC97338
Number of serial ports	1
16550 UART support	Yes
Connector type	9-pin D-type
Location	Rear side
Serial port function control	Enable/disable by BIOS Setup
Selectable serial port (via BIOS Setup)	3F8h, 2F8h, 3E8h, 2E8h, Disabled
Selectable serial port IRQ (via BIOS Setup)	IRQ3, IRQ4, IRQ10, IRQ11

FIR

Item	Specification
Vendor & model name	IBM 31T1100
Input power supply voltage	5V
Transfer data rate	4 Mbps
Transfer distance	SIR mode--Min 2.0, Typ 2.6 1.2 Mbps--Min 1.4, Typ 2.0 4 Mbps--Min 1.1, Typ 1.5
Compatible standard	IrDA (Infrared Data Association) 1.1, HP-SIR and Sharp ASK
Output Radiant Intensity Half Angle	+/-15
Number of Irda ports	1
16550 UART support	Yes

FIR

Item	Specification
FIR location	Left side
Selectable serial port (by BIOS Setup)	2F8h, IRQ3, Disabled

Audio

Item	Specification
Audio Controller	NeoMagic NMG5 + NMA2
Audio onboard or optional	Built-in
Mono or Stereo	Stereo
Resolution	16-bit
Compatibility	SB-16, Windows Sound System
Mixed sound source	Voice, Synthesizer, Line-in, Microphone, CD
Voice channel	8-/16-bit, mono/stereo
Voice control location	Right side
Sampling rate	44.1 KHz
Internal microphone	Yes, on the left-higher corner of LCD panel
Internal speaker / Quantity	Yes / 2 pieces, on both hinge sides
MPU-401 UART support	Yes

PCMCIA

Item	Specification
PCMCIA controller	TI PCI1251A
PCMCIA voltage controller	TI TPS2206
Supported card type	Type-II / Type-III
Number of slots	Two Type-II or one type-III
Access location	Right side
ZV (Zoomed Video) port support	Yes*2
32 bit CardBus support	Yes

Fax/Modem

Item	Specification
Chipset	Lucent
Fax modem data baud rate (bps)	56K
Data modem data baud rate (bps)	56K

Fax/Modem

Item	Specification
Support modem protocol	V.34 data modem, V.17 fax modem, voice/audio mode, and digital simultaneous voice and data (DSVD) operation over a dial-up telephone line PCI
Modem connector type	RJ11 & RJ45 combo phone jack
Modem connector location	Back side

Keyboard

Item	Specification
Keyboard controller	M38867
Keyboard vendor & model name	API
Total number of keypads	84-/85-/88-key
Windows 95 keys	Yes
Internal & external keyboard work simultaneously	Yes

Disk drives

Item	Specification		
Vendor & model name	MITSUMI D353F3		
Floppy Disk Specifications			
Media recognition	2DD (720K)	2HD (1.2M, 3mode)	2HD (1.44M)
Sectors / track	9	15	18
Tracks	80	80	80
Data transfer rate (Kbit/s)	250 300	500	500
Rotational speed (RPM)	300 360	360	300
Read/write heads	2		
Encoding method	MFM		
Power Requirement			
Input Voltage (V)	+5 +-10%		

Hard disk drives

Item	Specification	
Vendor & Model Name	IBM DCXA-210000	IBM DADA-26480

Hard disk drives

Item	Specification	
Drive Format		
Capacity (MB)	10050	6480
Bytes per sector	512	512
Logical heads	15	15
Logical sectors	63	63
Logical cylinders	16383	13424
Physical read/write heads	6	6
Disks	3	3
Spindle speed (RPM)	4200	4200
Buffer size (KB)	512	512
Interface	IDE	IDE
Data transfer rate (disk-buffer, Mbytes/s)	11.5~14.7	7.7~12.8
Data transfer, rate (host~buffer, Mbytes/s)	16.6/33.3	16.6/33.3
DC Power Requirements		
Voltage tolerance	5+-5%	5+-5%

CD-ROM

Item	Specification
Vendor & Model Name	KMEUJDA150L 24X
Performance Specification	
Speed (KB/sec)	2100 (ave.speed), 3600 (max)
Access time (ms)	150 (Typ.)
Buffer memory (KB)	128
Interface	Enhanced IDE compatible
Applicable disc format	CD-DA, CD-ROM, CD-ROM XA (except ADPCM), CD-I, Photo CD (Multisession), Video CD, CD+
Loading mechanism	Soft eject (with emergency eject hole)
Power Requirement	
Input Voltage (V)	5

Battery

Item	Specification
Vendor & model name	Sony BTP-1931
Battery Type	Li-ion (Graphite)

Battery

Item	Specification
Pack capacity (mAH)	3200
Cell voltage (V)	3.7
Number of battery call	8
Package configuration	2P-4S
Package voltage (V)	14.8V

Charger

Item	Specification
Vendor & model name	T62.085.C.00
Input voltage (from adapter, V)	7V-24V
Output current (to DC/DC converter, A)	3.5
Battery Low Voltage	Li-ion
Battery Low 1 level (V)	11.41V
Battery Lower 2 level (V)	10.94V
Battery Low 3 level (V)	9.9V
Charge Current	
Background charge (charge even system is still operative)	Constant power 30W
Normal charge (charge while system is not operative)	Constant power 45W
Charging Protection	
Maximum temperature protection	60

DC-DC Converter

Item	Specification				
Vendor & model name	Ambit T62.085.C.00				
Input voltage (Vdc)	8~21				
Output rating	5V	3.3V	+12V	6V	3.3VS B
Current (w/load, A)	0~5.8	0~3.3	0~0.12	0~0.1	0.01
Voltage ripple (max., mV)	50	50	100	300	75
Voltage noise (max., mV)	100	100	200	500	200
OVP (Over Voltage Protection, V)	5.52~5.55	3.642~3.693	15~17	7~9	-

DC-DC Converter

Item	Specification				
OCP (Over Current Protection, A)	4~6	4~6	0.3~0.4	-	-

DC-AC inverter is used to generate very high AC voltage, to support the LCD CCFT backlight user, and it is also responsible for the control of LCD brightness. Avoid touching the DC-AC inverter area while the system unit is turned on.

DC-AC Inverter

Item	Specification		
Vendor & model name	Ambit T62.086.C(12.1") T622.087.C.00 (13.3" & 14.1")		
Input voltage (V)	7.3 (min)	-	22 (max)
Input current (mA)	-	-	700 (max)
Output voltage (Vrms, no load)	1300 (min)	155	1600 (max)
Output voltage frequency (kHz)	40 (min)	-	65 (max)
Output current (mArms) (T62.087.C.00)	0.7~5.9 (min)	1.0~6.5 (typ)	1.3~7.1 (max)
Output current (mArms) (T62.086.C.00)	0.6~5.4 (min)	1.0~6.0 (typ)	1.4~6.6 (max)

LCD

Item	Specification	
Vendor & model name	LG LP141X3	Hitachi TX34D62VC1CAC
Mechanical Specifications		
LCD display area (diagonal, inch)	14.1	13.3
Display technology	TFT	TFT
Resolution	XGA (1024x768)	XGA (1024x768)
Support colors	66i	
Optical Specification		
Contrast ration	150 (typ)	100 (typ)
Brightness (cd/m2)	130 (typ)	100 (typ)

LCD

Item	Specification	
Brightness control	Keyboard hotkey	Keyboard hotkey
Contrast control	None	None
Electrical Specification		
Supply voltage for LCD display (V)	3.3 (typ)	3.3 (typ)
Supply voltage for LCD backlight (Vrms)	730 (typ)	650 (typ)

AC Adapter

Item	Specification
Vendor & model name	Delta ADP-60HB Lite-On PA-1600-19
Input Requirements	
nominal voltages (Vrms)	90~270
Frequency variation range (Hz)	47~63
Maximum input current (A, @90Vac, full load)	1.5A
Inrush current	The maximum inrush current will be less than 50A and 100A when the adapter is connected to 115Vac (60Hz) and 230Vac(50Hz) respectively.
Efficiency	It should provide an efficiency of 83% minimum, when measured at maximum load under 115V (60Hz) & 230Vac (60Hz)
Output Ratings (CV mode)	
DC output voltage (V)	+19.0V~20.5V
Noise + Ripple (mV)	300mvp-pmax (20Mhz bandwidth)
Output Ratings (CC mode)	
Load (A)	0 (min) 3.16 (max)
Dynamic output Characteristics	
Turn-on delay time (s, @115Vac)	2
Hold up time (ms; @115 Vac input, full load)	8 (min)
Over voltage protection (OVP, V)	26
Short circuit protection	Output can be shorted without damage

AC Adapter

Item	Specification
Electrostatic discharge (ESD, kV)	+/-15 (at air discharge)
Dielectric withstand voltage	
Primary to secondary	3000 Vac (or 4242 Vdc), 10mA for 1 second
Leakage current	0.25 mA maximum @ 254 Vac, 60Hz
Regulatory Requirements	
Internal filter meets: FCC class B requirements. (USA) VDE 243/1991 class B requirements. (German) CISPR 22 Class B requirements. (Scandinavia) VCCI class II requirements. (Japan)	

Weights and Dimension

Item	Specification
Weight	3.27 kg.
Dimension	315~317 x 251~ 257 x 44~47 mm.

Power Management

This computer has a built-in power management unit that monitors system activity. System activity refers to any activity involving one or more of the following devices: keyboard, mouse, drive, hard disk, peripherals connected to the serial and parallel ports, and video memory. If no activity is detected for a period of time (called an inactivity time-out), the computer stops some or all of these devices in order to conserve energy.

This computer employs a power management scheme that supports APM (Advanced Power Management) or ACPI (Advanced Configuration and Power Interface) which allows for maximum power conservation and maximum performance at the same time.

If your computer is set for APM, you can set time-out values for your computer's devices before power-saving methods are applied to these devices. If your computer is set for ACPI, Windows 98 handles all power-saving chores for your computer.

Note: Power management (APM or ACPI) greatly prolongs your battery life.

Power Management Modes

Display Standby Mode

Screen activity is determined by the keyboard, the built-in touchpad, and an external PS/2 pointing device. If these devices are idle for the period specified by the LCD backlight Time-out value, the display shuts off until you press a key or move the touchpad or external mouse.

"Automatic Dim" Feature

The computer has a unique "automatic dim" power-saving feature. When the computer is using AC power and you disconnect the AC adapter from the computer, it automatically dims the LCD backlight to save power. If you reconnect AC power to the computer, it automatically adjusts the LCD backlight to a brighter level.

Hard Disk Standby Mode

The hard disk enters Standby mode when there are no disk read/write operations within the period of time specified by the Hard Disk Time-out value. In this state, the power supplied to the hard disk is reduced to a minimum. The hard disk returns to normal once the computer accesses it.

Standby Mode

The computer consumes very low power in Standby mode. Data remain intact in the system memory until the battery is drained.

There are four ways to enter Standby mode:

- Pressing the Standby hot key **Fn-F3**
- Allowing the waiting time specified by the Standby Time-out value or the operating system to elapse without any system activity
- Closing the display cover
- When the computer is about to enter Hibernation mode (e.g., during a battery low condition), but the Hibernation file is invalid or not present

Note: If the computer beeps but does not enter Standby mode after pressing the Standby hot key, it means the operating system will not allow the computer to enter the power-saving mode.

The following signals indicate that the computer is in Standby mode:

- The buzzer beeps
- The Standby indicator lights

Warning: Unstored data is lost when you turn off the computer power in Standby mode or when the battery is drained.

To leave Standby mode and return to normal mode:

- Press any key
- Move the active pointing device (internal or external, PS/2 or serial)
- Have the resume timer set and let it be matched
- Open the display cover
- Experience an incoming PC card modem event

Hibernation Mode

In Hibernation mode, all power shuts off (the computer does not consume any power). The computer saves all system information onto the hard disk before it enters Hibernation mode. Once you turn on the power, the computer restores this information and resumes where you left off upon leaving Hibernation mode.

There is one necessary condition for the computer to enter Hibernation mode:

- The Hibernation file created by PhDISK must be present and valid.

In this situation, there are four ways to enter Hibernation mode:

- Pressing the Hibernation hot key **Fn-F4**
- Allowing the waiting time specified by the S2D Time-out value to elapse without any system activity
- When a battery low condition occurs and the Battery Low Suspend parameter in Setup is set to [ENABLED].
- Invoked by the operating system power-saving modes

Note: If the computer beeps but does not enter Hibernation mode after pressing the Hibernation hot key, it means the operating system will not allow the computer to enter the power-saving mode.

To exit Hibernation mode, press the power switch. The computer also resumes from Hibernation mode if the resume timer is set and matched. The computer also resumes via the network if the Wake on LAN Access parameter is enabled.

Warning: Do not change any devices (such as add memory or swap hard disks) when the computer is in Hibernation mode.

Sleep Mode (ACPI)

If ACPI is installed, all power management functions are handled by the Windows 98 operating system. In this set-up, you do not need to set time-out values for devices before they enter a power-saving mode.

Sleep mode may be one of three computer power-saving modes: Standby, Hibernation or power off. Windows 98 automatically determines which of these modes to enter in.

To enter Sleep mode under ACPI:

- Pressing the Sleep hot key **Fn-F4**
- Allowing idle times for devices and the computer determined by Windows 98 elapses

Exiting sleep mode depends on which power-saving mode the computer is currently in.

Advanced Power Management

This computer supports the APM standard designed to further reduce power consumption. APM is a power-management approach defined jointly by Microsoft and Intel. An increasing number of software packages support APM to take advantage of its power-saving features and to allow greater system availability without degrading performance.

For more information about APM under Windows 98, refer to your Windows 98 user's manual.

Advanced Configuration and Power Interface

Advanced Configuration and Power Interface (ACPI) is a power management specification jointly developed by Intel, Microsoft, and Toshiba. ACPI enables Windows 98 to control the amount of power given to each device attached to the computer. With ACPI, Windows 98 can turn off peripheral devices when they are not in use, thereby saving power.

System Utilities

The computer comes preloaded with the following softwares:

- Windows 98 or Windows NT operating system
- Hardware BIOS setup utility
- Support for LDCM (LANDesk Client Manager)
- System utilities, drivers and application software

Note: To access Windows 98 or Windows NT software applications, click on the **Start** button and select the application folder. Then click on the application icon to run the selected application. To learn about the software and utility, make use of the on-line help provided by the software.

Your computer is also compliant with the following:

- DMI (Desktop Management Interface) 2.1
- WfM (Wired for Management) 2.0
- APM (Advanced Power Management) or ACPI (Advanced Configuration and Power Interface)

PhDISK

The PhDISK utility allows your computer to enter Hibernation mode. Before entering Hibernation mode, your computer saves all necessary information into a file or partition created by PhDISK, then shuts off power to all system components. On the next start-up, the computer reloads the information from the PhDISK file or partition and resumes from where you left off.

Note: By default, this utility program is automatically loaded and set up on your computer, so you do not need to run it by yourself. You only need to run this program if you upgrade your memory. You can find PhDISK in the \windows\command\ directory.

Syntax

PHDISK [options]

where options:

- /CREATE (/FILE or /PARTITION) creates the hibernation file or partition
- /DELETE (/FILE or /PARTITION) deletes the hibernation file or partition
- /INFO displays information on the hibernation file or partition
- /REFORMAT PARTITION reformats the existing hibernation file or partition

Caution: The Hibernation file is a hidden file named SAVE2DSK.BIN; DO NOT delete or alter this file in any way except by using the PhDISK utility. Improper deletion or alteration of this file could cause you to lose all access to your computer.

Notebook Manager

The computer has a built-in system setup program called Notebook Manager. The Windows-based Notebook Manager allows you to set passwords, the start-up sequence of the drives, and power management settings. It also shows current hardware configurations.

Note: Certain hot key functions are disabled when you access the notebook manager, because these functions are also found in the notebook manager.

To start the Notebook Manager, press **Fn-F2** or follow these steps:

1. Click on **Start, Programs**, then **Notebook Manager**.
2. Select the **Notebook Manager** application to run the program.

Note: Changes made to most settings in the Notebook Manager take effect the next time the computer restarts. However changes made in the Power Management, Display Device or Line-in/Microphone screens will take effect immediately.

Notebook Manager consists of six sections:

- Information Viewer
- Boot Sequence
- Password
- Power Management
- Display Device
- Line-in/Microphone

To select a section, click on the tab of the section you want to view.

Information Viewer

Information Viewer summarizes and lists information about the specifications and settings of the different components of your computer.

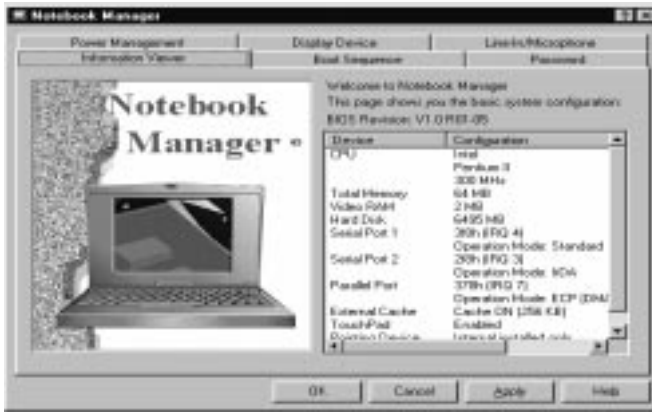

Note: Items in this table may differ slightly from the ones on-screen.

Item	Description
CPU	Brand, type and clock speed of the CPU (Central Processing Unit)
Total Memory	Total amount of main memory (in megabytes)
Video RAM	Total amount of video memory (in megabytes)
Hard Disk	Size of hard disk (in megabytes)
Serial Port 1	Resource settings of serial port 1
Parallel Port	Resource settings of the parallel port
External Cache	Total amount of external cache memory (in kilobytes)
Touchpad	Setting of the internal pointing device
Pointing Device	Type(s) of the pointing device(s) detected, internal and external

The current version of the computer's BIOS shows before the Device-Configuration table.

Boot Sequence

Boot Sequence defines the boot sequence to follow when your computer boots up.



The Boot Sequence screen displays the bootable devices in your computer and the order in which the booting sequence will occur. The devices include the following:

- Floppy Drive
- IDE Hard Drive
- CD-ROM/DVD-ROM Drive (for bootable AcerMedia Bay modules)

Simply drag and drop the devices to change the booting order. Then click on **Apply** to set the new sequence.

Password

Password is used to set, modify or delete the password(s) for your computer.



There are two passwords used in the system:

- Supervisor Password. The Supervisor Password prevents unauthorized access to sensitive parameters in the Notebook Manager and BIOS Utility. It also prevents unauthorized access to your computer at system start-up and at resume from Standby/Hibernation or Sleep mode.
- User Password. The User Password prevents unauthorized access to your computer at system start-up and at resume from Standby/Hibernation or Sleep mode.

Setting the Supervisor Password

Note: Before you can set the User Password, you need to set the Supervisor Password.

To set the Supervisor Password, follow these steps:

1. Click on the **Change Supervisor Password** button. The following dialog box displays:



2. Click on the Enable Supervisor Password checkbox.
3. Click in the New Password textbox and type in up to seven alphanumeric characters (A-Z, a-z, 0-9) which you want to be

your Supervisor Password.

4. Click in the Confirm Password textbox and retype the password.
5. Click on **OK** to set the new password.

Note: To change a password, follow the same steps used to set a password. To remove a password, follow the same steps used to set a password but leave both textboxes blank.

Setting the User Password

To set the User Password, follow these steps:

1. Click on the **Change User Password** button.



2. Click on the Enable User Password checkbox.
3. Click in the New Password textbox and type in up to seven alphanumeric characters (A-Z, a-z, 0-9) which you want to be your User Password.
4. Click in the Confirm Password textbox and retype the password.
5. Click on **OK** to set the new password.

Note: To change a password, follow the same steps used to set a password. To remove a password, follow the same steps used to set a password but leave both textboxes blank.

You can also set password checks when the computer boots up and/or when the computer resumes from Hibernation mode. Simply click on the desired checkbox(es) and click on **Apply**.

Power Management

Power Management is used to set various settings related to power management.



This includes the following power-saving-related features:

Item	Description
Enable modem ring resume on indicator	Select to allow the computer to wake up from Standby mode when an incoming modem ring is detected.
Enable wake on LAN	Select to allow the computer to wake up from Standby mode by a remote computer.
Enable battery low warning beep	Select to allow the computer to give off warning beeps when the computer runs low on battery.
Enable sleep upon battery low	Select to allow the computer to enter Standby or Hibernation mode when the computer runs low on battery.
Enable system resume timer	Select to set the system resume timer which allows the computer to wake up from Standby mode if the resume timer is set and matched. Click the System Resume Timer button to set it.

Display Device

Display Device is used to control various settings related to display device(s), such as the display brightness level.



The items in this screen include:

- Boot Display Device. Sets the default display device on boot-up.
- Switching Display Device. Sets the current display device.
Note: Make sure an external monitor is connected before External monitor is selected.
- Brightness for LCD Panel. Click and drag to set the LCD screen brightness levels.

Click on the radio button of the desired item, then click on **Apply** to accept the setting. To modify the brightness level, click and hold the slider control and move it to the right to increase or to the left to decrease the setting. You can also click on the item, and use the cursor keys to set the desired level.

Line-in/Microphone

Line-in/Microphone is used to set the input source from the computer's line-in/microphone-in jack.



Click on the radio button of the desired item, then click on **Apply** to accept the setting.

Setup Utility

The Setup Utility is a hardware configuration program built into your computer's BIOS (Basic Input/Output System).

Your computer is already properly configured and optimized, and you do not need to run this utility. However, if you encounter configuration problems, you may need to run Setup. Please also refer to Chapter 6, Troubleshooting when a problem arises.

To activate the Setup Utility, press **F2** during POST (while the TravelMate logo is being displayed).

Navigating the Setup Utility

There are five menu options: Main, Advanced, Security, Power Saving and Exit. To navigate the Setup Utility:

- ❑ Press the cursor right/left keys to move between the main menu items.
- ❑ Press **Esc** while you are in any of the menu options to display the Exit menu.
- ❑ Press the cursor up/down keys to move between parameters.
- ❑ Press the plus/minus keys (**+/-**) to change the value of a parameter.
Note: You can change the value of a parameter if it is enclosed in square brackets.
- ❑ Press the **Enter** key to access a submenu. A **>** symbol in front of a parameter denotes an item with a submenu.

Note: Parameter explanations are displayed in the Item-Specific Help section of the Setup Utility (right panel). Navigation keys are shown on the bottom of the screen.

Main

The Main screen contains parameters involving basic computer settings and hardware information.

Main	Advanced	Security	Power	Exit	
System Time:		[13:36:42]			Item Specific Help
System Date:		[11/10/1998]			
Floppy Disk A:		[1.44MB 3.5"]			
▶ Hard Disk 0:		[6495MB]			
▶ CD-ROM:		[CD-ROM]			
▶ Boot Sequence:					
System Memory:		64 MB			
Video Memory:		2 MB			
CPU Type		Pentium II			
CPU Speed		300PE Mhz			
Serial Number:		xxxxxxxxxxxxx			
Asset Number:		xxxxxxxxxxxxx			
BIOS Version:		V1.0 R105ST			
VGA BIOS Version:		V01.0E.0000			
F1 Help	↑↓	Select Item	-/+	Change Values	F9 Setup Defaults
Esc Exit	←→	Select Menu	Enter	Select ▶ Sub-Menu	F10 Save and Exit

The table below describes the parameters in this screen. Settings in boldface are the default and suggested parameter settings.

Parameter	Description
System Time	Sets the system time. Format: HH:MM:SS (hour:minute:second)
System Date	Sets the system date. Format: DD/MM/YYYY (day/month/year)
Floppy Disk A	Selects the floppy disk drive type. Options: 1.44MB 3.5" or Disabled
Hard Disk 0	Shows the hard disk size. Press Enter to access the Hard Disk 0 submenu.
CD-ROM	Sets the AcerMedia Bay module type installed. Press Enter to access the CD-ROM submenu.
Boot sequence	Press Enter to access the Boot sequence submenu.
System Memory	Shows the main memory size.
Video Memory	Shows the video memory size.
CPU Type	Shows the CPU type.
CPU Speed	Shows the CPU speed.
Serial Number	Shows the serial number of the computer.
Asset Number	Shows the asset number of the computer.
BIOS Version	Shows the version number of the BIOS. Format: Vx Rx (version and release numbers)
VGA BIOS Version	Shows the version number of the VGA BIOS. Format: Vx (version numbers)

Note: The BIOS versions are important information about your computer. If you experience computer problems and need to contact technical support, this data helps our service personnel know more about your computer.

Hard Disk 0 Submenu

The Hard Disk 0 submenu allows you to set parameters related to your hard disk. Press **Enter** to access this submenu.

Main		Hard Disk 0: [6495MB]		Item Specific Help
Type:	[Auto]			
Cylinder:	[13424]			
Heads:	[15]			
Sectors/Track:	[63]			
Maximum Capacity:	6495MB			
F1 Help	↑↓ Select Item	-/+ Change Values	F9 Setup Defaults	
Esc Exit	←→ Select Menu	Enter Select ▶ Sub-Menu	F10 Save and Exit	

The table below describes the parameters in this screen. Settings in boldface are the default and suggested parameter settings.

Parameter	Description
Type	Sets the hard disk type. Options: Auto , User, CD-ROM, ATAPI Removable, IDE Removable or None
Cylinder	Shows the number of cylinders of the hard disk.
Heads	Shows the number of heads of the hard disk.
Sectors/Track	Shows the number of sectors per track of the hard disk.
Maximum Capacity	Shows the maximum capacity of the hard disk.

Note: The values in this screen are automatically set to their optimal values when **Type** is set to **Auto**. We suggest you set **Type** to **Auto** for hassle-free and correct hard disk detection.

CD-ROM Submenu

The CD-ROM submenu allows you to set parameters related to the CD-ROM drive (or other drive installed in the AcerMedia Bay). Press **Enter** to access this submenu.

Main	
CD-ROM: [CD-ROM]	Item Specific Help
Type: [Auto]	
F1 Help Esc Exit	↑↓ Select Item ←→ Select Menu
-/+ Change Values Enter Select ▶ Sub-Menu	F9 Setup Defaults F10 Save and Exit

The table below describes the parameters in this screen. Settings in boldface are the default and suggested parameter settings.

Parameter	Description
Type	Sets the hard disk type. Options: Auto , User, CD-ROM, ATAPI Removable, IDE Removable or None

Note: We suggest you set **Type** to **Auto** for hassle-free and correct AcerMedia Bay drive detection.

Boot Sequence Submenu

The Boot Sequence submenu allows you to set the boot sequence of the bootable devices in your computer. Press **Enter** to access this submenu.

Main		
Boot Sequence:		Item Specific Help
Boot Device 1	[Removable Devices]	
Boot Device 2	[Hard Drive]	
Boot Device 3	[ATAPI CD-ROM Drive]	
F1 Help	↑↓ Select Item	-/+ Change Values
Esc Exit	←→ Select Menu	Enter Select ▶ Sub-Menu
		F9 Setup Defaults
		F10 Save and Exit

The computer boots-up using the sequence specified in this submenu. To set the boot sequence, use the plus/minus (+-) keys.

Boot Devices	Description
Removable Devices	Computer boots from a bootable diskette in the floppy drive.
Hard Drive	Computer boots from the hard disk.
ATAPI CD-ROM Drive	Computer boots from a bootable CD-ROM in the CD-ROM drive.

Advanced

Caution: The parameters in this screen are for advanced users only. You do not need to change the values in this screen because these values are already optimized.

The Advanced screen contains parameters that are related to computer hardware.

Main	Advanced	Security	Power	Exit	
Warning Setting items on this menu to incorrect values may cause your system to malfunction.					Item Specific Help
Serial Port: [Enabled] IrDA: [Disabled] Parallel Port: [Enabled] Mode: [ECP] Speaker Default: [Enabled] Microphone/Line-In: [Microphone] Boot Display: [Auto]					
F1 Help	↑↓ Select Item	-/+ Change Values	F9 Setup Defaults		
Esc Exit	←→ Select Menu	Enter Select ▶ Sub-Menu	F10 Save and Exit		

The table below describes the parameters in this screen. Settings in boldface are the default and suggested parameter settings.

Parameter	Description
Serial Port	Enables or disables the serial port. Options: Enabled or Disabled
IrDA Port	Enables or disables the infrared port. Options: Enabled or Disabled
Parallel Port	Enables or disables the parallel port. Options: Enabled or Disabled
Mode	Sets the operation mode of the parallel port. Options: ECP , Bi-directional, or Output only
Speaker Default	Enables or disables the internal speakers on boot-up. You can override this by toggling Fn-F8 during computer operation. Options: Enabled or Disabled
Microphone/Line-In	Specifies the function of the microphone/line-in audio jack. Options: Microphone or Line-In

Parameter	Description
Boot Display	<p>Sets the display on boot-up.</p> <p>When set to Auto, the computer automatically determines the display device. If an external display device (e.g., monitor) is connected, it becomes the boot display; otherwise, the computer LCD is the boot display. When set to Both, the computer outputs to both the computer LCD and an external display device if one is connected.</p> <p>Options: Auto or Both</p>

Security

The Security screen contains parameters that help safeguard and protect your computer from unauthorized use.

Main	Advanced	Security	Power	Exit	Item Specific Help
Supervisor Password is		Disabled			
User Password is		Disabled			
Set Supervisor Password		[Enter]			
Set User Password		[Enter]			
Password on boot:		[Enabled]			
Password Check During Resume:		[Enabled]			
F1 Help	↑↓ Select Item	-/+ Change Values	F9 Setup Defaults		
Esc Exit	←→ Select Menu	Enter Select ▶ Sub-Menu	F10 Save and Exit		

The table below describes the parameters in this screen. Settings in boldface are the default and suggested parameter settings.

Parameter	Description
Supervisor Password is	When set, this password protects the computer and this Setup Utility from unauthorized entry. It also protects certain parameters in the Setup Utility. When Password on boot and/or Password Check During Resume is enabled, you need to enter this password to continue operation. Options: Disabled or Enabled
User Password is	When set, this password protects the computer from unauthorized entry. When Password on boot and/or Password Check During Resume is enabled, you need to enter this password to continue operation. Before setting the User Password, you need to set the Supervisor Password. Options: Disabled or Enabled
Set Supervisor Password	Press Enter to set the Supervisor Password.
Set User Password	Press Enter to set the User Password.
Password on boot	When enabled, the computer prompts you for a password when the computer boots up. Options: Enabled or Disabled
Password Check During Resume	When enabled, the computer prompts you for a password when the computer resumes from Hibernation mode. Options: Disabled or Enabled

Note: To set the User Password, the Password on boot or Password Check During Resume parameters, you need to set the Supervisor Password first.

Setting a Password

Follow these steps:

1. Set Password parameter (Supervisor or User) and press the **Enter** key. The set password box appears:

Set Password		
Enter new password:	[]
Confirm new password:	[]

2. Type a password. The password may consist of up to seven alphanumeric (A-Z, a-z, 0-9) characters.

Important: Be very careful when typing your password because the characters do not appear on the screen.

3. Press **Enter**. Retype the password to verify your first entry and press **Enter**.
4. After setting the password, the computer automatically sets the chosen password parameter to Enabled.
5. Press **F10** to save the changes and exit the Setup Utility.

To change a password, follow the same steps above, but enter and confirm a new password.

Removing a Password

Should you want to remove a password, do the following:

1. Set Password parameter (Supervisor or User) and press the **Enter** key. The Set Password box appears:

Set Password		
Enter Current Password	[]
Enter New Password	[]
Confirm New Password	[]

2. Type the current password and press **Enter**.
3. Press **Enter** twice without entering anything in the password box to remove the existing password.
4. Press **F10** to save the changes and exit the Setup Utility.

Power

The Power Saving screen contains parameters that are related to power-saving and power management.

Main	Advanced	Security	Power	Exit	
LCD backlight Timeout: [1 Minute] Hard Disk Timeout: [1 Minute] Standby Timeout: [2 Minutes] S2D Timeout: [12 Minutes]				Item Specific Help	
Resume on LAN access: [Disabled] Resume On Time: [Disabled]					
Hotkey Beep: [Enabled] Battery Low Warning: [Enabled] Battery Low Suspend: [Enabled]					
F1 Help Esc Exit	↑↓ Select Item ←→ Select Menu	-/+ Enter	Change Values Select ▶ Sub-Menu	F9 Setup Defaults F10 Save and Exit	

The table below describes the parameters in this screen. Settings in boldface are the default and suggested parameter settings.

Note: If your system has ACPI, all power management functions are taken care of by Windows 98.

Parameter	Description
LCD backlight Time-out	Sets the time-out value before the display enters power saving mode. Options: Disabled or time values
Hard Disk Time-out	Sets the time-out value before the hard disk enters power saving mode. Options: Disabled or time values
Standby Time-out	Sets the time-out value before the computer enters Standby mode. Options: Disabled or time values
S2D Time-out	Sets the time-out value before the computer enters Hibernation mode. Options: Disabled or time values
Resume on LAN access	When enabled, the computer resumes operation when accessed via LAN using a remote computer. Options: Disabled or Enabled

Parameter	Description
Resume On Time	<p>When enabled and the system resume date and time are valid, the computer resumes (wakes up) at the set time and date.</p> <p>Options: Disabled or Enabled</p> <p>When enabled, the Resume Time and Resume Date parameters appear. Set the time and date the computer resumes at.</p> <p>Format: HH:MM:SS (hour:minute:second); DD/MM/YYYY (day/month/year)</p>
Hotkey Beep	<p>Enables or disables a beep when over a hot key is pressed.</p> <p>Options: Enabled or Disabled</p>
Battery Low Warning	<p>Enables or disables warning beeps during a battery-low condition.</p> <p>Options: Enabled or Disabled</p>
Battery Low Suspend	<p>Enables or disables the Hibernation function during a battery-low condition.</p> <p>When the computer is very low on battery power, the computer will enter Hibernation mode if PhDISK is installed and the hibernation file is valid.</p> <p>Options: Enabled or Disabled</p>

Exit

When you select the Exit menu or press **Esc** from any screen, the Exit options screen displays.

Main	Advanced	Security	Power	Exit	
Exit Discarding Changes Exit Saving Changes Load Setup Defaults Discard Changes Save Changes					Item Specific Help
F1 Help Esc Exit	↑↓ Select Item ←→ Select Menu	~/+ Change Values Enter Execute Command	F9 Setup Defaults F10 Save and Exit		

The table describes the parameters in this screen.

Parameter	Description
Exit Discarding Changes	Discards any changes made, exits the Setup utility and reboots.
Exit Saving Changes	Saves any changes made, exits the Setup utility and reboots.
Load Setup Defaults	Resets all parameters to their factory-default values.
Discard Changes	Disregards any changes made in the current session and reloads their previous values.
Save Changes	Saves any changes made.

Note: If you wish to keep any changes you make to parameters, select Exit Saving Changes or Save Changes.

Removal and Replacement

This chapter contains procedures on how to disassemble the notebook computer for maintenance and troubleshooting.

To disassemble the computer, you need the following tools:

- Wrist grounding strap and conductive mat for preventing electrostatic discharge
- Two flat-bladed screwdrivers
- Phillips screwdriver
- Hexagonal screwdriver
- Tweezers
- Plastic stick
- Special tool for CPU

The flowchart on the following page gives a clearer and more graphic representation of the entire disassembly sequence. Please refer to it from time to time, together with the screw list below. For a more detailed disassembly procedure, please refer to the Service CD kit.

The screws for the different components vary in size. During the disassembly process, group the screws together with the corresponding components to avoid mismatches when replacing the components.

TravelMate 720 Disassembly Flowchart (13.3 LCD)

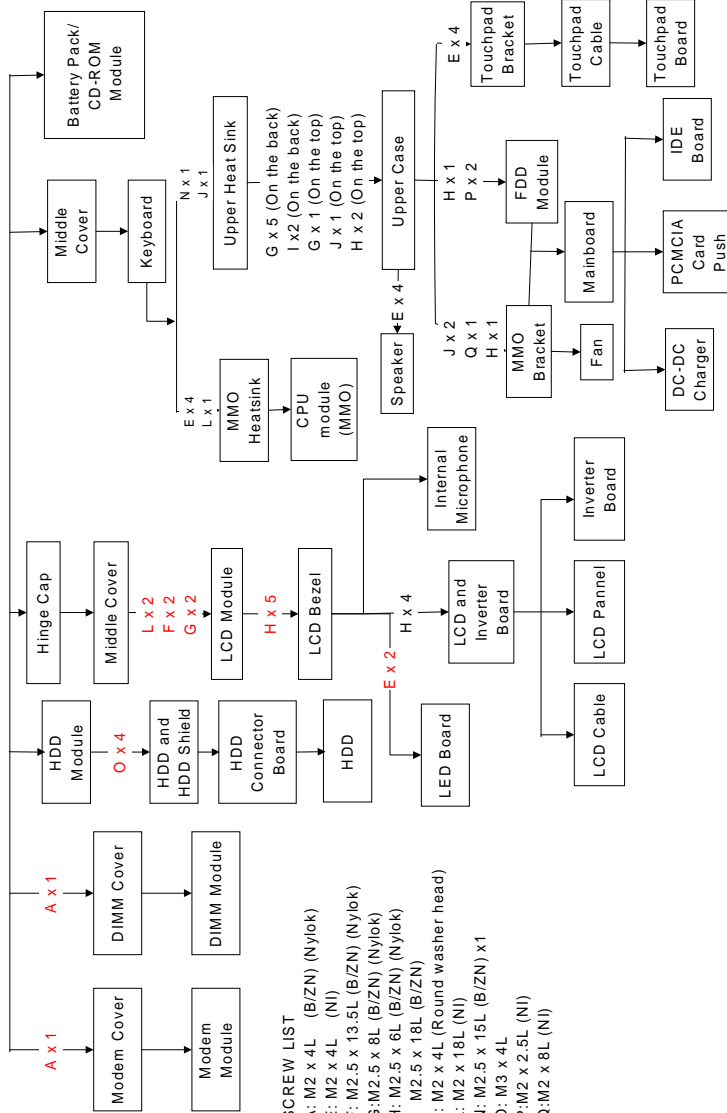

- SCREW LIST**
- A: M2 x 4L (B/Z/N) (Nylok)
 - E: M2 x 4L (NI)
 - F: M2.5 x 13.5L (B/Z/N) (Nylok)
 - G: M2.5 x 8L (B/Z/N) (Nylok)
 - H: M2.5 x 6L (B/Z/N) (Nylok)
 - I: M2.5 x 18L (B/Z/N)
 - J: M2 x 4L (Round washer head)
 - L: M2 x 18L (NI)
 - N: M2.5 x 15L (B/Z/N) x 1
 - O: M3 x 4L
 - P: M2 x 2.5L (NI)
 - Q: M2 x 8L (NI)

External Module Replacement

Reassembling the Modem Board

1. Connect the modem cable to the system board.
2. Insert the modem board back into its socket.



3. Put on the modem board cover.
4. Secure the modem board cover with its original screw.



Installing Memory

1. Insert the DIMM module into its socket.
2. Put on the DIMM cover.



-
- Secure the DIMM cover with its original screw.



Disassembling the CD-ROM Drive

- Push the CD-ROM drive locker forward and carefully pull out the CD-ROM module.

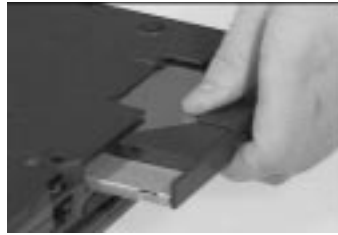

- To disassemble the CD-ROM module, remove the 2 screws from both sides of the CD-ROM module and the screw on the CD-ROM chassis.
- Remove the CD-ROM drive from the CD-ROM chassis.

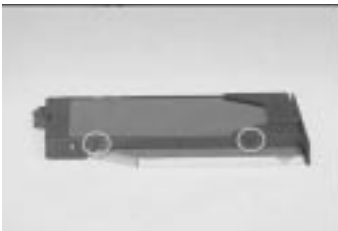

-
4. Disconnect the cable of the CD-ROM drive.



Removing the Hard Disk Drive

1. Use a flat-bladed screwdriver to remove the screw of the hard disk drive.
2. Carefully, pull out the hard disk drive to remove it.



Disassembling the Hard Disk Drive

1. To disassemble the hard disk drive, remove the 2 screws on both sides of the hard disk drive.
2. Separate the hard disk drive from its bezel.



-
3. Remove the hard disk drive from its shield plate.
 4. Disconnect the hard disk cable from the hard disk drive.

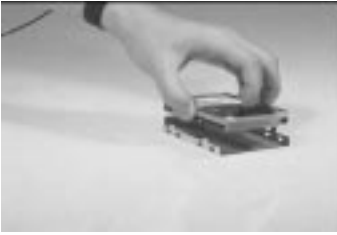

5. To reconnect the hard disk cable, be sure that the 1st pin is aligned up as indicated.



Removing and Replacing the Battery Pack

1. To remove the battery pack, press the battery compartment cover latch and slide the cover out.



-
2. Pull out the battery pack.
 3. Reinsert the battery pack by sliding it back in.
 4. Slide the battery compartment cover into its place.



Removing the Keyboard

1. Slide out the hinge covers on both sides of the notebook.

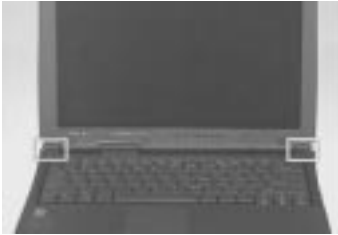

2. To remove the middle cover, use a flatbladed screwdriver to release the latches as shown.

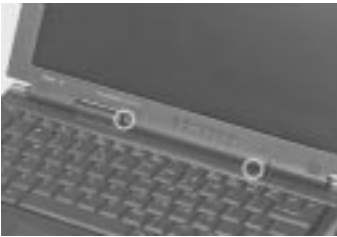

3. Lift the middle cover away



-
4. Lift the keyboard up and outward to expose the keyboard connector at CN20.

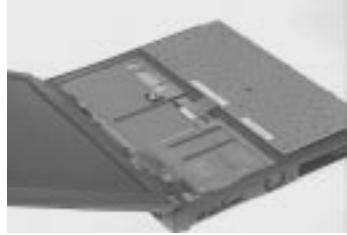

5. Remove the keyboard by carefully releasing the connector.

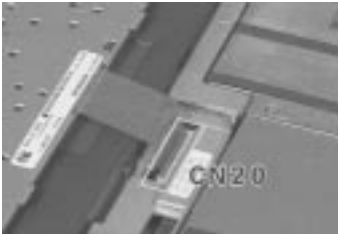

6. In reassembling the keyboard, be sure that the latches are lined up as indicated below.



-
7. To replace the middle cover, be sure that the latches are lined up with the upper case as indicated below.

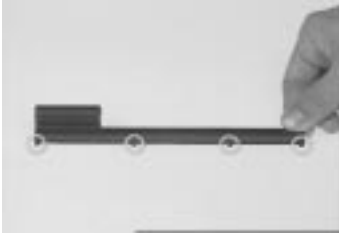

8. Press the middle cover to lock it in place.



Removing the LCD

1. Disconnect the internal microphone cable at CN4 from the system board.



2. Remove the LED cable at CN8 from the system board.

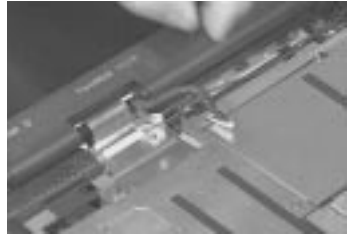

3. Remove the two screws of the LCD FPC cable at CN2 from the LVDS board.



-
4. Remove the LCD FPC cable cover from the system board.



5. Disconnect the LCD FPC cable from the LVDS board.
6. Use two flatbladed screwdrivers to remove the LVDS board at CN13 from the system board.



7. Remove the two screws at the base and at the back of the lower case.

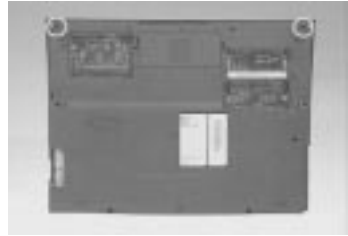

8. Carefully, detach the LCD module from the main unit.



Removing the CPU

1. To remove the CPU board, first remove the five screws of the CPU heat sink.
2. Lift the heat sink away.



3. Use this special tool placing it under the CPU board and aligning it with the white line, then lift up the CPU board to bring it out from the system board.



4. To reinsert the CPU board, first insert the upper heat sink back into the upper case.



-
5. Reinsert the CPU board at CN17 of the system board by aligning the CPU board with the two pillars of the MMO shield as shown below.

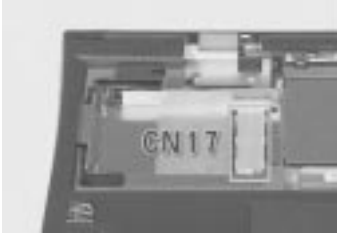

6. Use this special tool to press down and completely connect the CPU board to its socket.



Disassembling the Upper Case

1. To detach the upper case, first remove the two screws from the upper heat sink then lift the upper heat sink up and out.

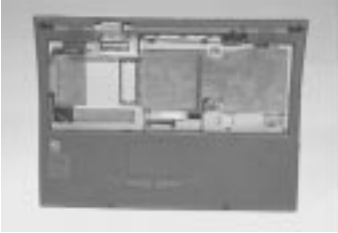

2. Remove the floppy cable at CN18 from the system board.
3. Remove the mouse cable at CN19 from the system board.



-
4. Remove the 11 screws from the upper case and the base of the unit.

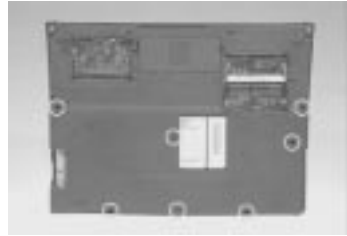
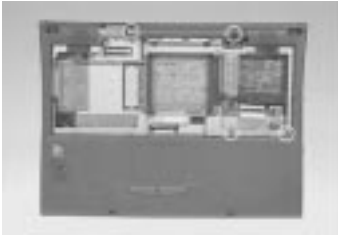

5. Disconnect the suspend cable at CN9, the left channel speaker at CN10 and the right channel speaker at CN11.
6. Remove the upper case from the lower case.

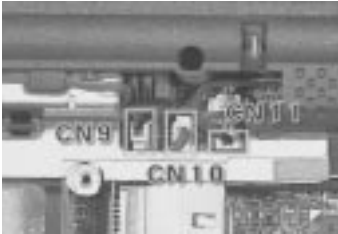

7. To reinsert the upper case into the lower case, be sure that the latches on the lower case are aligned to the latches on the upper case.

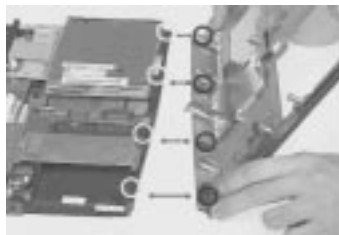

Removing the Speakers

1. Remove the two screws of the right channel speaker, then lift it away.
2. To remove the right channel speaker from the upper case, release its cable from the latches.

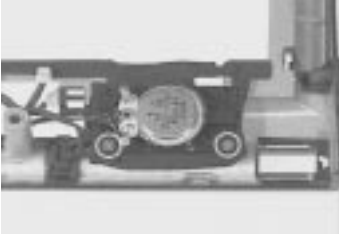

3. Remove the two screws from the left channel speaker, then lift it away.

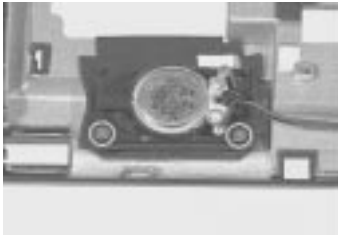

Removing the Touchpad Bracket

1. Remove the four screws of the touchpad bracket.
2. Detach the bracket from the side latches.



3. Detach the touchpad cable from the touchpad board.
4. Remove the touchpad board from the upper case.



Disassembling the Lower Case

Removing the Floppy Disk Drive

1. Remove the three screws of the floppy disk drive.
2. Lift the floppy disk drive from the lower case.



3. Remove the two screws from the floppy frame.
4. Separate the floppy disk drive from its frame.

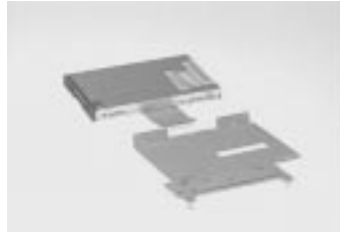

5. Carefully, disconnect the floppy cable from the floppy drive.

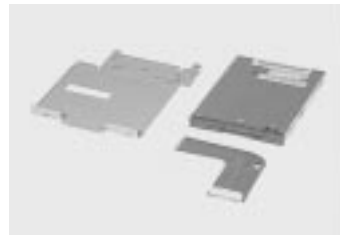

Disassembling the Fan

1. Disconnect the fan cable from the system board.
2. Remove the four screws of the MMO shield.



3. Lift the MMO shield away from the lower case.
4. Remove the two screws of the fan.

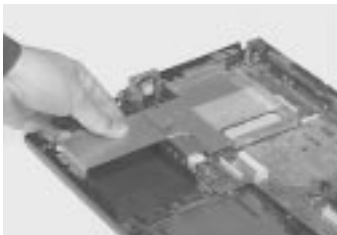

5. Separate the fan from the MMO shield.



Removing the System Board

1. Remove the FIR lens from the lower case.
2. Disconnect the DC-DC charger between the two pins at CN22 and CN23 from the system board.

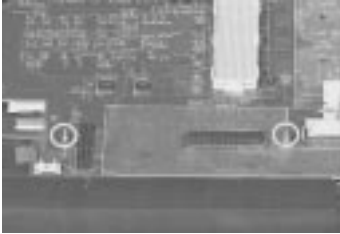

3. Remove the system board away from the lower case.



Removing the IDE Board

1. Remove the IDE board at CN30 from the system board.



Removing the PCMCIA Card

1. Remove the four screws of the PCMCIA card.
2. Remove the PCMCIA card at CN16 from the system board.

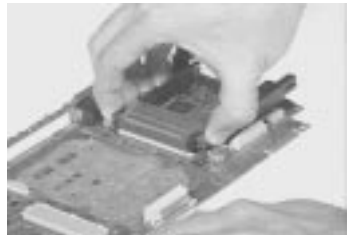
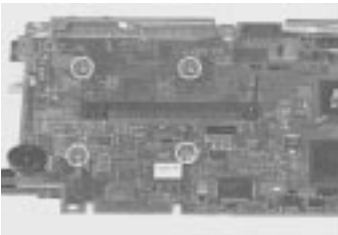

3. This completes the disassembly procedure of the lower case.

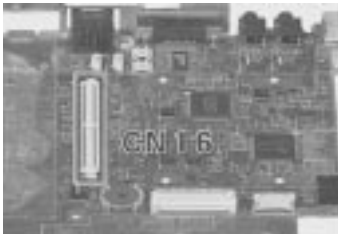

Disassembling the LCD

1. Remove the two cushions and three mylar stickers from the LCD bezel.



2. Remove the five screws on the LCD bezel.
3. Carefully, pull out the display bezel.



-
4. Remove the two screws of the LED board.
 5. Pull out the LED board from the LCD.

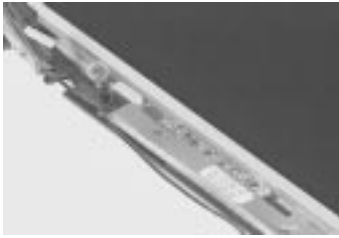

6. Disconnect the LED board cable from the LED board.
7. Remove the internal microphone from the LCD.



8. Remove the six screws from the inverter board.
9. Lift the LCD and inverter board from the LCD panel.

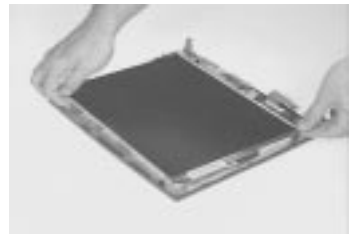
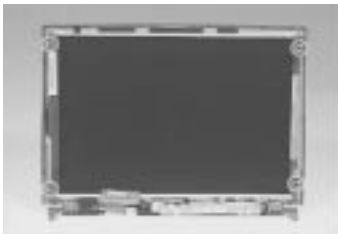

-
10. Remove the inverter board by disconnecting the LCD FPC cable.
 11. Remove the LCD power cable.

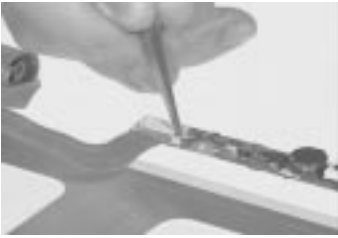

12. Peel the tape off.



13. Disconnect the LCD FPC cable from the LCD.

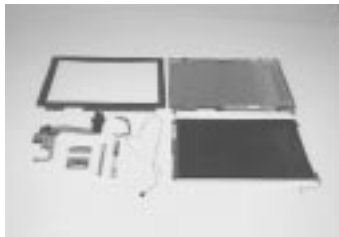

Troubleshooting

TravelMate 720 has system checkouts, a list of error codes and messages with corresponding actions, and procedures for undetermined problems to help with troubleshooting.

Note: The diagnostic tests are intended to test only Acer products. Non-Acer products, prototype cards, or modified options can give false errors and invalid system responses.

When troubleshooting, it is important to:

- ❑ Obtain the failing symptoms in as much detail as possible.
- ❑ Verify the symptoms by attempting to re-create the failure by running the diagnostic test or by repeating the same operation.

Note: To run the diagnostics, refer to “Running the Diagnostics”.

Use the following table with the verified symptom to determine which page in this chapter to go to. Search the symptoms column and find the description that best matches your symptom; then go to the page shown in the “Go To” column.

Symptoms (Verified)	Go To
Power failure. (The power indicator does not go on or stay on.)	“Power System Checkout”.
POST does not complete. No beep or error codes are indicated.	“Symptom-to-FRU Index”, and then use the No Beep Symptoms table.
POST beeps, but no error codes are displayed.	“Symptom-to-FRU Index”, and then use the Beep Symptoms table.
POST detected an error and displayed numeric error codes.	“Symptom-to-FRU Index”, and then use the Numeric Error Codes table.
The diagnostic test detected an error and displayed an FRU code.	“Running the Diagnostics”.
Other symptoms (such as LCD display problems).	“Symptom-to-FRU Index”, and then use the Other Symptoms table.
Symptoms cannot be re-created (intermittent problems).	Use the customer-reported symptoms and go to “Symptom-to-FRU Index”.

Diskette Drive Checkout

Do the following to isolate the problem to a controller, driver, or diskette. A write-enabled, diagnostic diskette is required.

Note: Make sure that the diskette does not have more than one label attached to it. Multiple labels can cause damage to the drive or cause the drive to fail.

Do the following to select the test device. See “Running the Diagnostics” for details.

1. Boot from the diagnostics diskette and start the PQA program (please refer to “Running PQA Diagnostics Program”).
2. Go to the diagnostic Diskette Drive in the test items.
3. Press F2 in the test items.
4. Follow the instructions in the message window.

If an error occurs with the internal diskette drive, reseal the connector on the System board.

If the error still remains:

1. Reseat the diskette drive.
2. Replace the diskette driver cable.
3. Replace the diskette.
4. Replace the IDE board
5. Replace the System board.

CD-ROM Driver Test

Do the following to isolate the problem to a controller, drive, or CD-ROM. Make sure that the CD-ROM does not have any label attached to it. The label can cause damage to the drive or can cause the drive to fail.

Do the following to select the test device:

1. Boot from the diagnostics diskette and start the PQA program (please refer to “Running PQA Diagnostics Program”).
2. Go to the diagnostic CD-ROM in the test items.
3. Press F2 in the test items.
4. Follow the instructions in the message window.

If an error occurs, reseal the connector on the System board. If the error still remains:

1. Reseat the CD-ROM drive.
2. Replace the CD-ROM drive.
3. Replace the IDE board.
4. Replace the System board.

Keyboard or Auxiliary Input Device Checkout

Remove the external keyboard if the internal keyboard is to be tested.

If the internal keyboard does not work or an unexpected character appears, make sure that the flexible cable extending from the keyboard is correctly seated in the connector on the sub card.

If the keyboard cable connection is correct, run the Keyboard Test. See "Running the Diagnostics" for details.

If the tests detect a keyboard problem, do the following one at a time to correct the problem. (Do not replace a nondefective FRU):

1. Reseat the keyboard cables.
2. Replace the keyboard.
3. Replace the System board.

The following auxiliary input devices are supported for this computer:

- Numeric keypad
- External keyboard (with keyboard/mouse cable)

If any of these devices do not work, reseat the cable connector and repeat the failing operation.

If the problem does not recur, recheck the connector. If the problem is not corrected, replace the device and then the System board.

Memory Checkout

DIMM cards are available for increasing memory capacity.

Slot 1 (MB)	Slot 2 (MB)	Total Memory (MB)
32	0	32
8	32	40
32	8	40
16	32	48
32	16	48
32	32	64
64	0	64
8	64	72
64	8	72
16	64	80
64	16	80
32	64	96
64	32	96
64	64	128
64	128	160
128	128	256

Memory errors might stop system operations, show error messages on the screen, or hang the system.

1. Boot from the diagnostics diskette and start the PQA program (please refer to "Running PQA Diagnostics Program").
2. Go to the diagnostic Memory in the test items.
3. Press F2 in the test items.
4. Follow the instructions in the message window.

Note: Make sure that the DIMM is fully installed into the connector. A loose connection can cause an error.

Flash Memory Update:

The flash memory update is required for the following conditions:

- New versions of system programs
- New features or options

Power System Checkout

To verify the symptom of the problem, power on the computer using each of the following power sources:

1. Remove the battery pack and diskette drive.
2. Connect the AC Adapter and check that power is supplied.
3. Disconnect the AC Adapter and install the charged battery pack; then check that power is supplied by the battery pack.

If you suspect a power problem, see the appropriate power supply checkout in the following list:

- "Checking the AC Adapter"
- "Checking Operational Charging"
- "Checking the Battery Pack"

Checking the AC Adapter:

- If the power problem occurs only when the port replicator is used, replace the port replicator.
- If the power-on indicator does not turn on, check the power cord of the AC Adapter for correct continuity and installation.
- If the operational charge does not work, go to "Checking Operational Charging."

Checking Operational Charging:

To check operational charging, use a discharged battery pack or a battery pack that has less than 50% of the total power remaining when installed in the computer.

Perform operational charging. If the battery status indicator does not turn on, remove the battery pack and let it return to room temperature. Reinstall the battery pack.

If the charge indicator still does not turn on, replace the battery pack. If the charge indicator still does not turn on, replace the System board. Then reinstall the battery pack. If the reinstalled battery pack is not charged, go to the next section.

Checking the Battery Pack:

Battery charging will not start until the Fuel-Gauge shows that less than 95% of the total power remains; with this condition the battery pack can charge to 100% of its capacity. This protects the battery pack from being overcharged or having a shortened life.

Do the following:

1. Power off the computer.
2. Remove the battery pack and measure the voltage between battery terminals 1 (+) and 7. See the following figure:

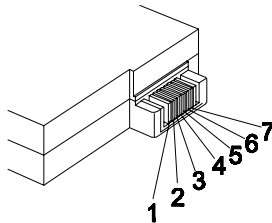

If the voltage is still less than +10.0 Vdc after recharging, replace the battery.

TouchPad Checkout

If the TouchPad does not work, check the configuration in the BIOS program. If the configuration of the TouchPad is disabled, select Enable to enable it.

If this does not correct the TouchPad problem, continue with the following. After you use the TouchPad, the pointer drifts on the screen for a short time. This self-acting pointer movement can occur when a slight, steady pressure is applied to the TouchPad pointer. This symptom is not a hardware problem. No service actions are necessary if the pointer movement stops in a short period of time.

If a click button problem or the pointing stick problem occurs, do the following:

1. Boot from the diagnostics diskette and start the PQA program (please refer to "Running PQA Diagnostics Program").
2. Go to the diagnostic Pointing Dev. in the test items.
3. Press F2 in the test items.
4. Follow the instructions in the message window.

If either the pointing stick or the click button do not work, do the following actions one at a time to correct the problem do not replace a nondefective FRU:

1. Reseat the TouchPad cables.
2. Replace the TouchPad cables.
3. Replace the TouchPad.

Symptom-to-FRU Index

The symptom-to-FRU index lists the symptoms and errors and their possible causes. The most likely cause is listed first.

Note: Perform the FRU replacement or actions in the sequence shown in the “FRU/Action” columns. If a FRU replacement did not solve the problem, put the original part back in the computer. Do not replace a nondefective FRU.

This index can also help you determine the next possible FRU to be replaced when servicing a computer.

Numeric error codes show the errors detected in POST or system operation. If no codes are available, use narrative symptoms.

If the symptom is not listed, go to “Undetermined Problems”.

Numeric Error Codes

The following is a list of the messages that the BIOS can display. Most of them occur during POST. Some of them display information about a hardware device, e.g., the amount of memory installed. Others may indicate a problem with a device, such as the way it has been configured. Following the list are explanations of the messages and remedies for the reported problems.

Note: If the system fails after you make changes in the Setup menus, reset the computer, enter Setup and install Setup defaults or correct the error.

Symptom / Error	FRU / Action in Sequence
0200 Failure Fixed Disk	1. Reseat Hard disk driver. 2. “Load Setup Defaults” in BIOS Setup Utility. 3. Hard disk driver 4. System board
0211 Stuck Key	Go to “Keyboard or Auxiliary Input Device Checkout”.
0211 Keyboard error	Go to “Keyboard or Auxiliary Input Device Checkout”.
0212 Keyboard Controller Failed	Go to “Keyboard or Auxiliary Input Device Checkout”.
0213 Keyboard locked - Unlock key switch	Unlock external keyboard

Symptom / Error	FRU / Action in Sequence
0220 Monitor type does not match CMOS - Run Setup	Run "Load Setup Defaults" in BIOS Setup Utility.
0230 Shadow RAM Failed at offset: nnnn	1. BIOS ROM 2. System board
0231 System RAM Failed at offset: nnnn	1. DIMM 2. System board
0232 Extended RAM Failed at offset:nnnn	1. DIMM 2. System board
0250 System battery is dead - Replace and run Setup	Replace backup battery (RTC) and Run SETUP to reconfigure System time, then reboot system.
0251 System CMOS checksum bad - Default configuration used	1. Backup battery (RTC) 2. Run SETUP to reconfigure System, then reboot system.
0260 System timer error	1. Backup battery (RTC) 2. Run SETUP to reconfigure System, then reboot system. 3. System board
0270 Real time clock error	1. Backup battery (RTC) 2. Run SETUP to reconfigure System, then reboot system. 3. System board
0280 Previous boot incomplete - Default configuration used	1. Run "Load Setup Defaults" in BIOS Setup Utility. 2. Backup battery (RTC) 3. System board
0281 Memory size found by POST differed from CMOS	1. Run "Load Setup Defaults" in BIOS Setup Utility. 2. DIMM 3. System board
02B0 Diskette driver A error	1. Check that the drive is defined with the proper diskette type in Setup. 2. Go to "Diskette Drive Checkout".
02B2 Incorrect Drive A type - run SETUP	1. Check that the drive is defined with the proper diskette type in Setup. 2. Go to "Diskette Drive Checkout".

Symptom / Error	FRU / Action in Sequence
02D0 System cache error - Cache disabled	1. IMM (CPU board) 2. System board
02F0 CPU ID:	1. IMM (CPU board) 2. System board
02F5 DMA Test Failed	1. DIMM 2. IMM (CPU board) 3. System board
02F6 Software NMI Failed	1. DIMM 2. IMM (CPU board) 3. System board
02F7 Fail-Safe Timer NMI Failed	1. DIMM 2. IMM (CPU board) 3. System board
Device Address Conflict	1. Run "Load Setup Defaults" in BIOS Setup Utility. 2. Backup battery (RTC) 3. System board
Allocation Error for: device	1. Run "Load Setup Defaults" in BIOS Setup Utility. 2. Backup battery (RTC) 3. System board
Failing Bits: nnnn	1. DIMM 2. BIOS ROM 3. System board
Fixed Disk n	None
Invalid System Configuration Data	1. BIOS ROM 2. System board
I/O device IRQ conflict	1. Run "Load Setup Defaults" in BIOS Setup Utility. 2. Backup battery (RTC) 3. System board
Operating system not found	1. Enter Setup and see if fixed disk and drive A: are properly identified. 2. Diskette Driver 3. Hard Disk 4. System board

Symptom / Error	FRU / Action in Sequence
Power-on indicator on, and a blank LCD not POST	<ol style="list-style-type: none"> 1. Ensure every connection is correct. 2. DIMM 3. Reseat IMM (CPU board) 4. IMM (CPU board) 5. System board
Power-on indicator not on, and a blank LCD during POST	<ol style="list-style-type: none"> 1. Reseat LCD connectors. 2. LCD inverter ID 3. LCD FPC cable 4. LCD inverter 5. LCD 6. LED board 7. System board
Power-on indicator on, and a blank LCD during POST.	<ol style="list-style-type: none"> 1. Reseat the LCD connectors. 2. LCD inverter ID 3. LCD FPC Cable 4. LCD inverter 5. LCD 6. System board
<ul style="list-style-type: none"> • LCD backlight not working • LCD too dark • LCD brightness can not be adjusted • LCD contrast cannot be adjusted 	<ol style="list-style-type: none"> 1. Reseat the LCD connectors. 2. Keyboard (if control is from the keyboard) 3. LCD inverter ID 4. LCD FPC Cable 5. LCD inverter 6. LCD 7. System board
<ul style="list-style-type: none"> • LCD screen unreadable • Characters missing pels • Screen abnormal • Wrong color displayed 	<ol style="list-style-type: none"> 1. Reseat the LCD connectors. 2. LCD inverter ID 3. LCD FPC Cable 4. LCD inverter 5. LCD 6. System board
LCD has extra horizontal or vertical lines displayed.	<ol style="list-style-type: none"> 1. LCD inverter ID 2. LCD inverter 3. LCD FPC Cable 4. LCD 5. System board
Keyboard (one or more keys) does not work.	<ol style="list-style-type: none"> 1. Reseat the keyboard cable. 2. Keyboard 3. System board
TouchPad does not work.	<ol style="list-style-type: none"> 1. Reseat TouchPad cable. 2. TouchPad board 3. System board

Symptom / Error	FRU / Action in Sequence
Keyboard (one or more keys) does not work.	<ol style="list-style-type: none"> 1. Reseat the keyboard cable. 2. Keyboard 3. System board
Power shuts down during operation.	<ol style="list-style-type: none"> 1. Battery 2. AC Adapter 3. DC/DC & Charge board 4. System board
The system will not power-on.	<ol style="list-style-type: none"> 1. Battery 2. AC adapter 3. DC/DC & Charge board 4. System board
The system will not power-off.	<ol style="list-style-type: none"> 1. DC/DC & Charge board 2. System board
Battery can't be charged.	<ol style="list-style-type: none"> 1. Battery 2. DC/DC & Charge board 3. IDE board 4. System board
System cannot detect the PCMCIA.	PCMCIA slots assembly System board
Memory count (size) appears different from actual size.	<ol style="list-style-type: none"> 1. Enter BIOS Utility to execute load setup default settings, then reboot system. 2. DIMM 3. System board
Speakers have noise or no sound comes from system.	<ol style="list-style-type: none"> 1. Speaker 2. System board
The system will not enter Hibernation.	<ol style="list-style-type: none"> 1. Keyboard (if control is from the keyboard) 2. Hard disk 3. System board
The system will not enter Standby after closing the LCD.	<ol style="list-style-type: none"> 1. LCD cover switch 2. System board
Battery fuel gauge does not go higher than 90%.	<ol style="list-style-type: none"> 1. Remove battery pack and let it cool for 2 hours. 2. Refresh battery (continue to use battery until power off, then charge battery). 3. Battery 4. DC/DC & charge board 5. System board
System configuration does not match the installed devices.	<ol style="list-style-type: none"> 1. Enter BIOS Utility to execute load setup default settings, then reboot system. 2. Reseat CD-ROM/DVD module.
System hangs intermittently.	<ol style="list-style-type: none"> 1. Hard Disk/CD-ROM/DVD drive connector 2. Fan 3. System board

Symptom / Error	FRU / Action in Sequence
In DOS or Windows multimedia programs, no sound comes from the computer.	<ol style="list-style-type: none"> 1. Speaker 2. System board
External display does not work correctly.	System board
USB does not work correctly.	System board
Print problems	<ol style="list-style-type: none"> 1. Run printer self-test. 2. Printer driver 3. Printer cable 4. System board
Serial or parallel port device problems	<ol style="list-style-type: none"> 1. Device driver 2. Device cable 3. Device 4. System board

Intermittent Problems

Intermittent system hang problems can be caused by a variety of reasons that have nothing to do with a hardware defect, such as: cosmic radiation, electrostatic discharge, or software errors. FRU replacement should be considered only when a recurring problem exists.

When analyzing an intermittent problem, do the following:

1. Run the advanced diagnostic test for the System board in loop mode at least 10 times.
2. If no error is detected, do not replace any FRU.
3. If any error is detected, replace the FRU shown by the FRU code. Rerun the test to verify that no more errors exist.

Undetermined Problems

You are here because the diagnostic tests did not identify which adapter or device failed, installed devices are incorrect, a short circuit is suspected, or the system is inoperative. Follow these procedures to isolate the failing FRU (do not isolate a nondefective FRU).

Note: Verify that all attached devices are supported by the computer.

Note: Verify that the power supply being used at the time of the failure is operating correctly (See "Power Systems Checkout").:

1. Power off the computer.
2. Visually check them for damage. If any problems are found, replace the FRU.
3. Remove or disconnect all of the following devices:
 - a. Non-Acer devices
 - b. Devices attached to the port replicator
 - c. Printer, mouse, and other external devices
 - d. Battery pack
 - e. Hard disk drive
 - f. DIMM
 - g. CD-ROM
 - h. Diskette drive
 - i. PC Cards
4. Power on the computer.
5. Determine if the problem has changed.
6. If the problem does not recur, reconnect the removed devices one at a time until you find the failing FRU.
7. If the problem remains, replace each following FRU one at a time. Do not replace a nondefective FRU:
 - a. System board
 - b. LCD assembly
 - c. CPU card

Utility Program Diskette

Setting LCD Panel ID

There is an EEPROM in the inverter which stores its supported LCD type ID code. If you replace an LCD with one of a different brand or use a new inverter, the ID information in the inverter EEPROM should be updated.

Follow the steps below to see the LCD Panel ID:

1. Follow the instructions on-screen to read current or to set new LCD Panel ID code.

Note: When you set a new LCD Panel ID and the new LCD is not yet enabled (to function), connect an external CRT to see the program execution process.

Note: Make sure the new ID code you choose corresponds with the LCD brand and type. If you write a wrong ID into the inverter, just reboot and re-execute the program and input the correct ID code.

2. Restart the computer - the new LCD should work normally.

Note: If LCD cannot display after changing the ID code, make sure you write the correct ID code, or try reseating the LCD FPC cable connectors.

Setting Thermal Sensor Utility

The system is equipped with sensors to protect against system overheating. By setting System and processor thermal thresholds, the system can turn on the cooling fan or shut down automatically when temperatures reach the defined threshold parameters.

Running the Diagnostics

Running PQA Diagnostics Program

Note: Before running the PQA Diagnostics Program, make sure that the write enable tab of the Diagnostic Program Diskette is set to enabled.

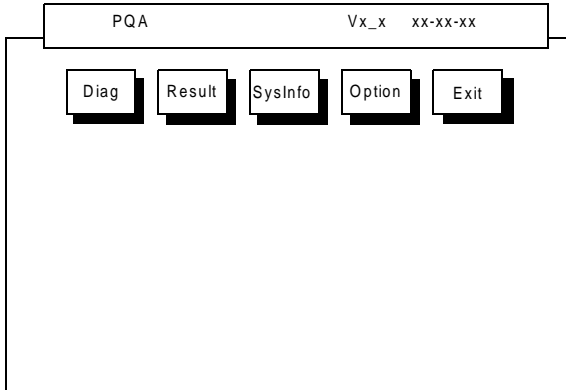

Press -> or <- to move around the main menu. Press enter to enable the selected option. The main options are Diag, Result, SysInfo, Option and Exit.

The Diag option lets you select testing items and times.

The following screen appears when you select Diag from the main menu:

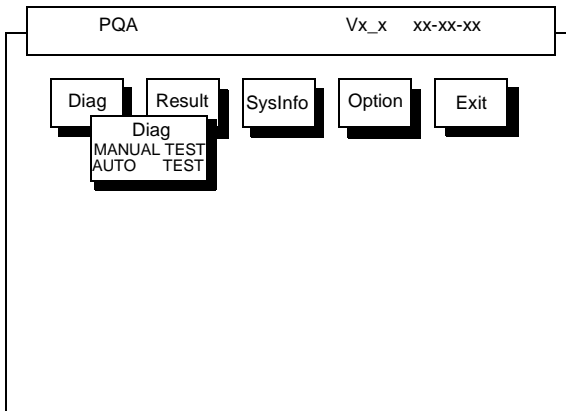

This screen allows you to specify the number of tests to perform. The options are as follows:

Manual Test performs a single test and manually checks the selected test items in sequence.

Auto Test performs multiple tests of the selected items and automatically checks the selected test items in sequence.

Note: PCMCIA Diagnostic Supports the Manual test only. Do not select PCMCIA Diagnostic in Auto Test.

The screen below appears if you select AUTO Test.

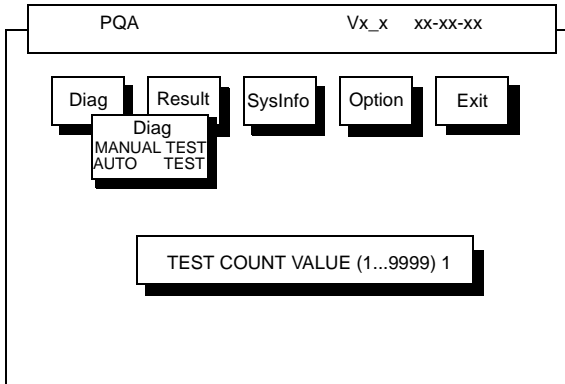

Specify the desired number of tests and press **Enter**. After you specify the number of tests to perform, the screen shows a list of test items (see below):

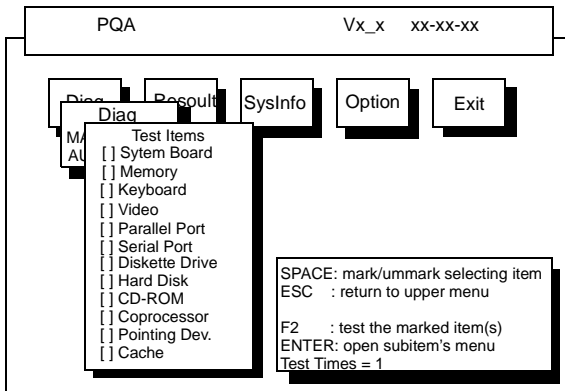

Move the highlight bar from one item to another. Press space to enable or disable the item. Press **Enter** to view the available suboptions of each selected item. Press **Esc** to close the submenu.

The right corner screen information gives you the available function keys and the specified test number.

- Space Enables/disables the item
- ESC Exits the program
- F1 Help
- F2 Tests the selected item(s)
- Enter Opens the available suboptions
- Test Times Indicates the number of tests to perform.

Note: The F1 and F2 keys function only after you finish configuring the Test option.

PQA Diagnostics Program Error Codes and Messages

Error Code	Message	FRU/Action in Sequence
System		
16XX	Backup battery error	Backup battery
1XXX	CPU or System board error	1. Reload BIOS default setting. 2. CPU 3. System board
2XXX	Memory error	1. Reseat CPU (IMM module). 2. DIMM 3. System board
3XXX	Keyboard error	1. Reseat Keyboard. 2. Keyboard 3. System board
4XXX	Video error	System board
5XXX	Parallel Port error	System board
6XXX	Serial port or System board error	System board
7XXX	Diskette drive error	1. Diskette drive 2. System board
8XXX	Hard disk error	1. Reload BIOS default setting. 2. Hard disk 3. System board
9XXX	CD-ROM error	1. Reseat CD-ROM cable. 2. CD-ROM drive 3. System board
10XXX	CPU or System board error	1. CPU 2. System board
11XXX	Pointing device error	1. Reseat Keyboard. 2. Keyboard 3. System board

Jumper and Connector Information

Top View

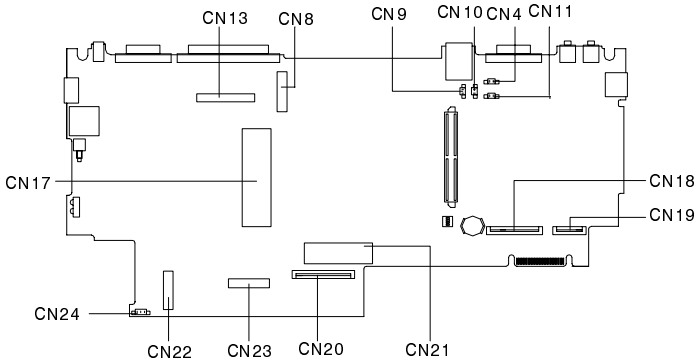

PCB No. 97143

CN13	LCD Connector	CN8	LED Connector
CN9	Cover Switch Connector	CN10	Left Speaker Connector
CN4	MIC Connector	CN11	Right Speaker Connector
CN21	HDD Connector	CN18	FDD Connector
CN17	IMM Connector (MMC 2)	CN19	Touchpad Connector
CN22& CN23	DC/DC & Charger board Connector	CN20	Keyboard Connector
		CN24	Fan Connector

SW1

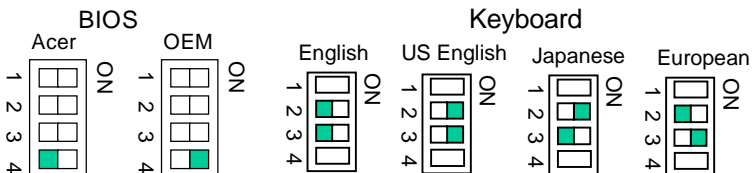

Bottom View

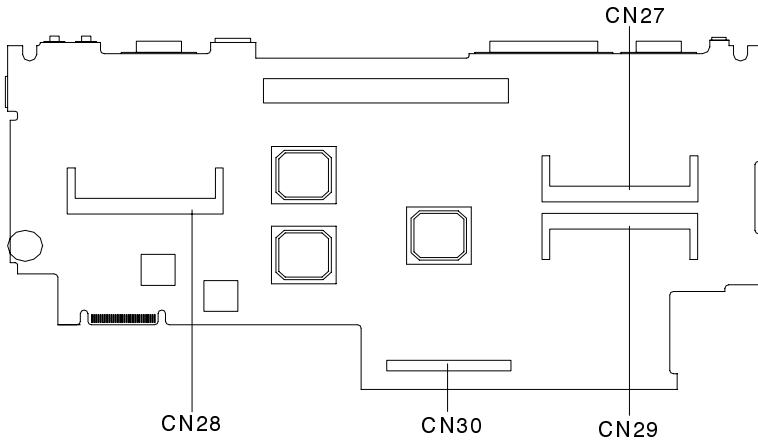

CN27 & CN29
DIMM Module Connector

CN28 Modem Module Connector
CN30 IDE Board Connector



FRU (Field Replaceable Unit) List





This chapter gives you the FRU (Field Replaceable Unit) listing in global configurations of TravelMate 720. Refer to this chapter whenever ordering for parts to repair or for RMA (Return Merchandise Authorization).

Please note WHEN ORDERING FRU PARTS, that should check the most up-to-date information available on your regional web or channel. If for whatever reason a part number change is made, it will not be noted on the printed Service Guide. For ACER AUTHORIZED SERVICE PROVIDERS, your Acer office may have DIFFERENT part number codes to those given in the FRU list of this printed Service Guide. You MUST use the local FRU list provided by your regional Acer office to order FRU parts for repair and service of customer machines.







Note: To scrap or to return defective parts, you should follow the local government ordinance or regulations on how to dispose of them properly, or follow the rules set by your regional Acer office on how to return them.







Note: The number indicates the location shown on exploded diagrams or "NS" indicates "Not Shown" on it.





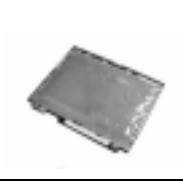
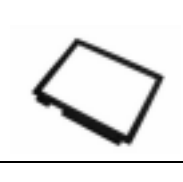

Picture	No.	Part name	Description	Part No.
CD-ROM				
	NS	CD-ROM	ASSY CD-ROM MODULE	6M.47A01.001
	17	CD-ROM FPC CABLE	CABLE ASSEMBLY FPC CD-ROM 700	50.47A02.001
NS	16	CD-ROM	CD DRV KME/ UJDA-150L W/ BZL 700	56.10019.071
NS	NS	CD-ROM	DVD 12.7 KME UJDA510 700	56.22021.001



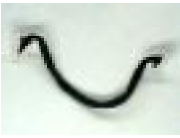

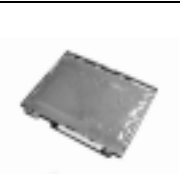

Picture	No.	Part name	Description	Part No.
	18	CD-ROM BRACKET	ASSY CD ROM CHASSIS 700	60.47A02.001
Processor				
	44	CPU P II-300 MHZ	IC CPU MOBI PII-300 W/AGP IMM	01.I0MP2.U0B
		CPU P II-333MHZ	IC CPU MPII-333 DIXON MMC2 256	01.I0MP2.X3A
		CPU P II-333MHZ	IC CPU MPII-333 DIXON MMC1 256	01.I0MP2.X30
		CPU P II-366MHZ	IC CPU MPII-366 DIXON MMC2 256	01.I0MP2.36A
DIMM				
	NS	SO-DIMM 32MB	DIMM KMM 466S424AT-F0 100NS 32M	72.46424.04E
		SO-DIMM 64MB NEC	S0-DIMM 253509-10(64MB)NEC	72.25359.00N
		SO-DIMM 64MB	SDIMM 64M 4564163G5-A10B-9JF B	72.25359.A0N
		DIMM 32MB Mitsubishi	S0-DIMM M5M4V64S40A TP-10L 32MB	72.54644.A0N
		SO-DIMM 64MB	SDIMM 64M M5M4V64S40B TP-8L B	72.54644.C0N
FDD				
	13	FDD	FDD MIT/ D353F3 3 MODE 700	56.01051.351

Picture	No.	Part name	Description	Part No.
	14	FDD FPC CABLE	C.A FPC FDD 720	C.A FPC FDD 720
HDD				
	NS	HDD MODULE 6GB	HDD MODULE 6GB IBM	6M.42C01.001
		HDD MODULE 4GB	HDD MODULE 4GB IBM	6M.47A03.021
	20	HDD 6GB	HDD 2.5 6480MB IBM/ DADA26480	56.02A04.002
		HDD 4GB	HDD 4090MB IBM/DTCA 20490 IDE	56.02834.071
	21	HDD FPC CABLE	CABLE ASSEMBLY FPC HDD 2.5"700	50.47A01.001
	22	HDD shield	ASSY HDD SHIELD PLT 700	60.47A03.001
	19	HDD BZL	ASSY HDD BZL 700	60.47A04.002







Picture	No.	Part name	Description	Part No.
Keyboard				
	37	KEY BOARD US	NSK-84A41	91.78S07.041
13.3" LCD				
	NS	LCD MOUDLE 13.3" TFT	ASSY LCD MODULE 13.3"	6M.47A05.021
	10	LCD INVERTER 13.3" TFT	INVERTER T62.087.C 700	19.21030.191
	NS	LED CABLE 13.3" TFT	C.A 15P 2C 100MM LED AN700	50.47A09.002
	NS	LED CABLE 13.3" TFT	C.A 15P 2C 100MM LED AN700	50.47A09.003
	12	LED BOARD 13.3" TFT	EXTENSA 700 LED BOARD	55.47A03.001
	64	LVDS BOARD FOR 13.3" TFT	EXTENSA 700 LVDS BOARD	55.47A05.001

Picture	No.	Part name	Description	Part No.
	5	LCD 13.3"TFT	LCD TX34D62VC1C AC 13.3 TFT XGA	56.0747A.001
	6	LCD FPC CABLE 13.3"TFT	ASSY LCD FPC 13.3TFT 700	60.47A07.093
	9	LCD PANEL 13.3" TFT	ASSY LCD PNL(HIT13.3"T FT) 700	60.42C10.021
	1	LCD BAZEL 13.3" TFT	ASSY LCD BEZEL(13.3") 700	60.47A09.003
	NS	LCD HINGE SUPPORT PACK	ASSY LCD HINGE SUPPORT PACK 700	6M.47A04.021
	NS	LCD HINGE PACK 13.3"	ASSY HINGE 13.3"TFT(710T E)	6M.47A04.011
14.1" LCD				
	NS	LCD MODULE 14.1" TFT	ASSY LCD MODULE 14.1" 720	6M.42C02.001
	N	LCD INVERTER 14.1" TFT	INVERTER T62.087.C 700	19.21030.191







Picture	No.	Part name	Description	Part No.
	NS	LCD LED CABLE 14.1"	C.A 15P 2C 100MM LED AN700	50.47A09.002
	O	LED BOARD 14.1" TFT	14.1 LDE BOARD PLATINUM	55.49A05.001
	64	LVDS BOARD FOR 14.1" TFT	EXTENSA 700 LVDS BOARD	55.47A05.001
	G	LCD 14.1" TFT	LCD 14.1" TFT LG/LP141X3- ABT	56.0743B.041
	F	LCD FPC CABLE 14.1" TFT	ASSY LCD FPC 720	60.42C14.001
	F	LCD FPC CABLE 14.1" TFT	ASSY LCD FPC 720	60.42C14.002
	L	LCD PANEL 14.1" TFT	ASSY LCD PNL 14.1" 720	60.42C10.001
	L	LCD PANEL 14.1" TFT	ASSY LCD PNL 14.1" 720	60.42C10.002
	B	LCD BAZEL 14.1" TFT	ASSY LCD BAZEL (ACER) 14.1" 720	60.42C12.011
	B	LCD BAZEL 14.1" TFT	ASSY LCD BAZEL (ACER) 14.1" 720	60.42C12.012

Picture	No.	Part name	Description	Part No.
	NS	LCD HINGE PACK 14.1"	ASSY HINGE PACK 14.1 EXT 720	6M.42C03.001
SYSTEM BOARD				
	23	MAIN BOARD	720 MAIN BOARD	55.42C01.001
NS	NS	PCMCIA SOCKET	SKT CARDBUS IC10S-136PL-PEJL	22.10172.051
MECHANICAL PARTS				
	15	FDD BRACKET	BRACKET FDD SECC T-0.8	33.47A03.002
	38	HEAT SINK UP	ASSY U HSINK 720	60.42C08.001
	43	MMOHEAT SINK	ASSY HSINK MMO 720	60.42C02.001
	46	MMO BRACKET	ASSY MMO SHIELD 720	60.42C03.001
	NS	MMO BRACKET	ASSY MMO SHIELD 720	60.42C03.002

Picture	No.	Part name	Description	Part No.
	34	HINGE COVER (R)	CAP HINGE (R) PC	42.47A14.001
	35	HINGE COVER (L)	CAP HINGE CAP (L) PC	42.47A15.001
	36	MIDDLE COVER WITHOUT NAME PLATE	ASSY MIDDLE CVR 700	60.47A22.001
	29	BATTERY DOOR	COVER BATTERY PC	42.47A17.002
	27	SIR COVER	ASSY SIR-LENS 700	60.47A10.002
	26	LOWER CASE	ASSY L CASE 720	60.42C09.001
	26	LOWER CASE	ASSY L CASE 720	60.42C09.002

Picture	No.	Part name	Description	Part No.
	39	UPPER CASE	ASSY U CASE 720	60.42C06.001
	39	UPPER CASE	ASSY U CASE 720	60.42C06.002
NS	NS	COVER SWITCH	W.A CVR SW/ 2P 45MM AN700	50.47A10.001
	NS	SPEAKER MODULE	SPK 1W 3520-7CC W/CABLE 700DX	6M.47A09.001
NS	NS	POWER SWITCH CABLE	W.A CVR SW/ 2P 45MM AN700	50.47A10.001
	30	DIMM COVER	ASSY DIMM DOOR 720	60.47A05.002
	31	MODEM COVER	DOOR MODEM AL T-.8 720	34.42C06.001
	63	LVDS BOARD COVER	CVR LVDS SHIELD CU 700	34.47A43.001
PCB				
	NS	IDE TRANSFER BOARD	EXTENSA 700 IDE TRANSFER BOARD	55.47A04.001

Picture	No.	Part name	Description	Part No.
	25	DC-DC CHARGER BOARD	DC-DC CHARGER T62.085.C V.6	19.21030.331
	NS	MODEM BOARD (AMBIT)	MODEM 56K AMBIT/ J07.017.C.00	54.09011.211
	NS	MODEM BOARD	MODEM PCI CIS/BM-5614BMDG BT2	54.09232.011
POWER				
	NS	ADAPTER	ADT 90-264V 60W ADP-60HB V.A2	25.10064.021
	NS	ADAPTER	ADT 90-270V ADP-60JB V.A 720	25.10064.031
	28	BATTERY PACK	ASSY BTY PACK LIP848NLA	60.47A01.001
	28	BATTERY PACK	ASSY BTY PACK LIP860FLACP 720	60.47A01.021
	NS	POWER CORE	CORD SPT-2 #18*2C 7A125V1830MM	27.01618.001
TOUCHPAD				
	40	TOUCH PAD	TOUCHPAD SYNAPTICS/ TM4-220	56.1748A.001

Picture	No.	Part name	Description	Part No.
	42	TOUCH PAD BRACKET	ASSY TOUCHPAD BRKT 720	60.42C07.001
	41	TOUCH PAD FPC CABLE	ASSY TOUCHPAD FPC 720	60.42C11.001
OTHERS				
	45	FAN	FAN 30*30*10 U12QFB3E65	23.10033.001
		FAN	FAN 30*30*10 UDPFFMH01H BT2	23.10033.031
	7	MICROPH ONE MODULE	MICROPHONE ACER 700DX	6M.47A08.001
	NS	SPEAKER MODULE	SPK 1WV3520- 7CC W/CABLE 700DX	6M.47A09.001
	NS	RTC BATTERY	BTY LI 3V CR1220 36MAH	23.20004.091
NS	NS	SCREW	SCREW SPC COIN M2.5*0.45 H- 6.5	86.00074.330

Picture	No.	Part name	Description	Part No.
NS	55	SCREW	SCREW M2.5*L15 BLW ZN	86.1A323.150
NS	56	SCREW	SCREW M2.5*18L (B/ ZN) 700	86.1A323.180
NS	49	SCREW	SCREW MACH PAN M2*8L	86.1A522.8R0
NS	57	SCREW	SCREW NUT MMO HEX STEEL	87.00010.320
NS	NS	SCREW	NUT MMO HEX STEEL	87.00010.321
NS	58	SCREW	SCREW MACH M2*4 NI SHIGA	XB6-7200-407
NS	NS	SCREW	SCREW STEEL NI M2*5L	86.9A522.5R0
NS	J	SCREW	SCRW MACH PAN NYLOK M2*4 ZN	86.1A352.4R0
NS	50	SCREW	SCRW MACH PAN M2*18L NI	86.1A522.180
NS	61	SCREW	SCRW MACH FL M3*4L NI	86.5A524.4R0
NS	47	SCREW	SCRW MACH PAN M2*4L C- ZN	86.9A522.4R0
NS	52, K	SCREW	SCRW WAFER NYLO M2.5*6L B-ZN	86.9A353.6R0
NS	48	SCREW	SCRW MACH PAN NYLOK M2*4 ZN	86.1A352.4R0
NS	54	SCREW	SCR M2.5*13.5L B/ ZN NYLOK 700	86.1A353.135
NS	NS	SCREW	SCRW PAN M2*12L NI	86.1A522.120
NS	53	SCREW	SRW M2.5*8L B/ZN NYLOK 700	86.9A353.8R0

Picture	No.	Part name	Description	Part No.
NS	51	SCREW	SCREW M2.5*4L (NI) 700	86.9A553.4R0
MISCELLANEOUS PARTS				
NS	NS	LCD LATCH SPRING	SPRING EJ- KNOB SWP 300	34.47604.001
NS	NS	LCD LATCH	LATCH LCD 700	42.47A01.002
NS	2, C	LCD SCREW CAP (LOWER)	MYLAR FOR HINGE PC 390	40.43A01.081
NS	3	LCD SCREW CAP (UPPER)	CSN SCRW SILICON 050 6*3H 800	47.49A02.001
NS	NS	PLATE NAME	PLT NAME (721TX)PC 31.7*5.6 720	40.42B01.071
NS	11, M	LOGO	PLATE NAME(LOGO) PC AN390	40.43A02.001
NS	NS	PLATE NAME	PLT NAME (720TE ACER) PC 720	40.48406.721
NS	NS	BASE GRIP	FOOT PU BLACK 350P	47.45001.001
NS	NS	PCMCIA DOOR SPRING UPPER	SPRING PCMCIA DOOR SWP 700	34.47A40.001
NS	NS	POWER SWITCH KNOB	KNOB POWER PC	42.47A18.002
NS	NS	PCMCIA DOOR UPPER	DOOR PCMCIA ABS 050 370	42.46913.001
NS	NS	PCMCIA DOOR SPRING LOWER	SPRING PCM DOOR-L SUS PEACH	34.46928.001

Picture	No.	Part name	Description	Part No.
NS	NS	PCMCIA DOOR LOWER	DOOR(L) PCMCIA ABS 050 AN370	42.46919.001
RECOVERY CD				
NS	NS	W98 English-ST	Recovery CD W98 (ENG) TM720	90.42C39.103
NS	NS	W98 German	Recovery CD W98 (GER) TM720	90.42C39.G04
NS	NS	W98 Italian	Recovery CD W98 (ITA) TM720	90.42C39.I03
NS	NS	W98 Sp/ Por	Recovery CD W98 (SP/Por) TM720	90.42C39.S02
NS	NS	W98 French	Recovery CD W98 (FRE) TM720	90.42C39.F02
NS	NS	W98 G/F/I	Recovery CD W98 G/F/I TM720	90.42C39.G03
NS	NS	W98 Traditional Chinese	Recovery CD W98 T-C TM720	90.42C39.C02
NS	NS	W98 Simplified Chinese	Recovery CD W98 S-C TM720	90.42C39.C01
NS	NS	W98 Eng/F/ Dut	Recovery CD W98 (E/F/Dut) TM720	90.42C39.102
NS	NS	W98 Eng/ Sp/Br	Recovery CD W98 (E/SP/BR) TM720	90.42C39.SB1
NS	NS	W98 Danish	Recovery CD W98 (Dan) TM720	90.42C39.D01
NS	NS	W98 Norwegian	Recovery CD W98 (NOR) TM720	90.42C39.N01
NS	NS	W98 Swedish/ Finnish	Recovery CD W98 (SWE/ FIN) TM720	90.42C39.SF1

Picture	No.	Part name	Description	Part No.
NS	NS	W98 Traditional Chinese- H.K	Recovery CD W98 (TC-HK) TM720	90.42C39.HK1
NS	NS	W98 Russian	Recovery CD W98 (RUS) TM720	90.42C39.R01
NS	NS	W98 Turkish	Recovery CD W98 (TUR) TM720	90.42C39.T01
NS	NS	W98 Thai	Recovery CD W98 (THAI) TM720	90.42C39.L01
NS	NS	NT4 English- STD	Recovery CD NT4 (ENG) TM720	90.42C39.101
NS	NS	NT4 German	Recovery CD NT4 (GER) TM720	90.42C39.G02
NS	NS	NT4 Italian	Recovery CD NT4 (ITA) TM720	90.42C39.I02
NS	NS	NT4 French	Recovery CD NT4 (FRE) TM720	90.42C39.F01
NS	NS	NT4 Spanish	Recovery CD NT4 (SPA) TM720	90.42C39.S01
NS	NS	NT4 Traditional Chinese	Recovery CD NT4 (T-C) TM720	90.42C39.C03
NS	NS	W95 German	Recovery CD W95 (GER) TM720	90.42C39.G01
NS	NS	W95 Italian	Recovery CD W95 (ITA) TM720	90.42C39.I01

Model Definition and Configuration

TravelMate 720 Model Number Define

Model Number	LCD Type	CPU	Memory	HDD	CD-ROM/DVD Speed	Battery
720TX	14.1" TFT	PII-300/AGP	64MB	6GB	24x	Li-Ion
721TX	14.1" TFT	PII-333/AGP	64MB	6GB	24x	Li-Ion
721TXV	14.1" TFT	PII-333/AGP	64MB	6GB	2XDVD	Li-Ion
722TX	14.1" TFT	PII-366/AGP	64MB	10GB	24x	Li-Ion
722TXV	14.1" TFT	PII-366/AGP	64MB	10GB	2XDVD	Li-Ion

Test Compatible Components List

TravelMate720 compatibility is tested and verified by Acer's internal testing department. The PCMCIA functions are tested under Windows®95 (4.00.950C), Windows®98 and Windows®NT 4.0 environments. In addition to these tests, Long Run tests and Year 2000 Compliancy have been verified, too.

Refer to the following lists for components, cards, and peripherals which have passed these tests. Regarding configuration, combination and test procedures, please refer to the "720 Compatibility Test Report" released by the Acer Notebook System Testing Department.

PCMCIA

PCMCIA, PM Test

Cards	Win95	Win98	WinNT4.0
Memory cards	Pass	Pass	Pass
LAN cards	Pass	Pass	Pass
Modem cards	Pass	Pass	Pass
Combo cards	Pass	Pass	Pass
ZV cards	Pass	Pass	-
Capture cards	Pass	Pass	-
SCSI cards	Pass	Pass	Pass
Cardbus cards	Pass	Pass	-

PCMCIA, Integration/Application Test

Item	Win95	Win98	WinNT4.0
Two R2 cards	Pass	Pass	Pass
Two CardBus cards	Pass	Pass	-
R2 & ZV cards	Pass	Pass	-
CardBus & ZV cards	Pass	Pass	-
R2 & CardBus cards	Pass	Pass	-
4 cards	Pass	Pass	Pass

PCMCIA Cards Tested for Year2000 Compliance

Type	Name	Model No.
ATA Flash	Viking ATA Flash Card 16MB	
ATA Flash	Viking ATA Flash Card 4MB	
ATA Flash	Epson 5MB Flash	ATA 502SD00
ATA Flash	Epson 1MB Flash	
CardBus	3COM/Megahertz 10/100 LAN CardBus	3CCFE575BT
CardBus	Xircom CardBus Ethernet 10/100	CBE-10/100BTX
CD-ROM	Panasonic 8x CD-ROM	KLX-783A
Ethernet	Xircom CreditCard Ethernet Adapter IIps	PS-CE2-10
Ethernet	3COM Etherlink III LAN1	3C589D
Ethernet	IBM Ethernet II	
Ethernet	3COM Fast Etherlink 16-bit PC Card	3C574-TX
Ethernet/Modem	Xircom CreditCard Ethernet +Modem 33.6	CEM-33BC
Ethernet/Modem	3COM Etherlink III LAN+33.6 Modem	3C562D/3C563D
Modem	Cardinal V.34 33.6 Fax Modem	MVPV34PC
Modem	Xircom CreditCard Modem 56	CM56
Modem	Hayes Accura 56k	
Modem	USR Worldport 14.4	
MPEG	LiveGear MPEG	R1-7001
MPEG2	Margi DVD-to-Go	
Slim SCSI	Adaptec Slim SCSI 1460A	
Slim SCSI	Adapter Slim SCSI 1460	
Token Ring	3COM Token Ring LAN	3C389

Long Run

Item	Win95	Win98	WinNT4.0
Long Run 4 hr	Pass	Pass	Pass

Year2000 Compliance Test

Item	Description	Result
RTC test	Pass	Pass

Online Support Information

This appendix describes online technical support services available to help you repair your Acer systems.

If you are a distributor, dealer, ASP or TPM, please refer your technical queries to your local Acer branch office. Acer Branch Offices, Regional Offices and Regional Groups may access our website. However, some information sources will require a user I.D. and password. These can be obtained directly from Acer CSD Taiwan.

Acer's website offers you convenient and valuable support resources whenever you need them.

You can find information on all of Acer's Notebook, Desktop and Server models including;

- Service guides for all models
- User's manuals
- Training materials
- BIOS updates
- Software utilities

Also contained on this website is

- Detailed information on Acer's International Traveler's Warranty (ITW)
- An overview of all the support services we offer, accompanied by a list of telephone, fax and e-mail contacts for all of your technical queries.

Here is the Acer headquarters' Customer Service Division Internet address for your support information:

<http://csd.acer.com.tw>

If you have any suggestions or comments, please do not hesitate to communicate these to TerryMasi@acer.com.tw, or fax to (886) 2 86911799.

16550 UART 19

A

AC Adapter 25

ACPI 30

ACPI. See Advanced Configuration and Power Interface

Advanced 47

Advanced Configuration and Power Interface 30

Advanced Power Management 30

and 31

APM 31

APM. See Advanced Power Management

Application key 7

ASP 127

Audio 20

Mixed sound source 20

Resolution 20

Sampling rate 20

Voice channel 20

audio

setting input source in Notebook Manager 40

Audio Controller 20

B

Battery 22

battery pack

charging indicator 4

Boot Device Priority Submenu 46

boot order

setting in Notebook Manager 35

setting in Setup Utility 46

Boot Sequence 35

brightness

hot keys 9

setting in Notebook Manager 39

C

caps lock 5

on indicator 4

CardBus PC Card 1

CCFT 24

CD-ROM Drive

Disassembly 58

Charger 23

Checkout

Auxiliary Input Device 84

Diskette Drive 83

Keyboard 84

Memory 85

Power System 86

TouchPad 88

computer

features 1

information 34

on indicator 4

power management 27

Connectivity 1

Connectors 103

contrast

setting in Notebook Manager 39

CPU

Removing the CPU 68

D

date

setting in Setup Utility 43

DC-AC Inverter 24

-
- DC-DC Converter 23
 - DC-in jack 11
 - Desktop Management Interface 31
 - Diagnostics 98
 - Disk Drives
 - Read/write heads 21
 - Disk drives 21
 - Read/write heads 21
 - Rotational speed (RPM) 21
 - Tracks 21
 - Display 2
 - Opening and Closing the Display 3
 - display 2
 - auto-dim feature 27
 - dual 2
 - hot keys 8
 - opening and closing 3
 - performance 2
 - power management 2, 27
 - setting boot device in Notebook Manager 39
 - setting boot device in Setup Utility 48
 - setting in Notebook Manager 39
 - simultaneous 2
 - switching device in Notebook Manager 39
 - Display Device 39
 - Driver Test
 - CD-ROM 83
 - DSVD 21
 - Dual Display 2
 - E**
 - EEPROM 97
 - Extended Graphics Array (XGA) 1
 - External CRT Resolutions and Modes 18
 - External Module
 - Replacement 57
 - Disassembling the CD-ROM Drive 58
 - Disassembling the Hard Disk Drive 59
 - Installing Memory 57
 - Reassembling the Modem Board 57
 - Removing and Replacing the Battery Pack 60
 - Removing the Hard Disk Drive 59
 - External monitor port 10
 - F**
 - Fast infrared(FIR) 1
 - Fax/Data Modem 11
 - fax/data PCI modem 1
 - Fax/Modem 20
 - baud rate 20
 - Field Replaceable Unit 105
 - FIR 19
 - Flash Memory Update 86
 - FRU 89, 105
 - CD-ROM 105
 - DIMM 106
 - FDD 106
 - HDD 107
 - LCD 108
 - Mechanical Parts 111
 - Miscellaneous Parts 117
 - Others 115
 - PCB 113
 - Power 114
 - Recovery CD 118
 - Touchpad 114
 - Fuel-Gauge 87
 - H**
 - hard disk
 - power management 27

Hard Disk 0 Submenu 44

Hard Disk Drive

Disassembly 59

Hard disk drives 21

Hibernation mode 29

conditions 29

entering 29

hot key 8

resuming from 29

utility 32

Hot Keys 8

I

I/O Ports 10

I/O ports

bottom ports 13

rear ports 10

right ports 12

indicator lights 4

Indicators 4

Information Viewer 34

infrared

turning on and off 47

Intermittent Problems 95

Internal microphone 20

Internal speaker 20

J

Jumpers 103

Bottom View 104

Top View 103

K

Keyboard 5, 21

Keyboard controller 21

Removing the keyboard 62

Special Keys 5

keyboard 5

embedded numeric

keypad 6

hot keys 8

lock keys 5

Windows keys 7

L

LCD 24

Removing the LCD 65

Resolution 24

LCD Panel ID

Setting 97

LEDs 4

Line-in Jack 10

Line-in/Microphone 40

Lithium-Ion battery 1

Lock Keys 5

Long Run 126

Lower Case

Disassembly 74

Lower Case Disassembly

Fan 75

Floppy Disk Drive 74

IDE Board 77

LCD 78

PCMCIA Card 77

System Board 76

M

Main screen 42

Major 1

Major Features 1

System 1

media access

on indicator 4

Microphone-in jack 10

Mini docking connector 13

MMO 75

Model Definition 121

modem 11

Modem jack 10

MPU-401 UART 20

N

Navigating the Setup Utility 41

Notebook Manager 33, 33–40

-
- Boot Sequence 35
 - Display Device 39
 - Hot key 8
 - Information Viewer 34
 - Password 36
 - Power Management 38
 - starting 33
 - Num lock 5
 - on indicator 4
 - Numeric Error Codes 89
 - numeric keypad
 - embedded 6
 - O**
 - On-die L2 cache 1
 - Online Support Information 127
 - Operational Chargin 87
 - P**
 - Parallel Port 18
 - Parallel port 10
 - parallel port
 - setting in Setup Utility 47
 - Password 36
 - password
 - changing in Setup Utility 50
 - checking during boot 49
 - checking during resume 49
 - removing in Setup Utility 50
 - setting in Notebook Manager 36–37
 - setting in Setup Utility 50
 - PC Card slots 12
 - PCMCIA 20
 - voltage controller 20
 - PCMCIA controller 20
 - PhDISK 32
 - PhDisk
 - Syntax 32
 - Power
 - managing in Notebook Manager 38
 - managing in Setup Utility 51
 - Power and Standby Indicators 4
 - Power Management 2, 27, 38
 - power management 27
 - ACPI 30
 - advanced 30
 - Power Management Modes 27
 - Hard Disk Standby Mode 27
 - Hibernation mode 29
 - Peripheral Standby Modes 28
 - Sleep Mode (ACPI) 29
 - power management modes
 - display standby mode 27
 - hard disk standby mode 27
 - Hibernation mode 29
 - sleep mode (ACPI) 29
 - Standby mode 28
 - Power Saving 51
 - PQA Diagnostics 98
 - Error Codes and Messages 101
 - PS/2 port 12
 - R**
 - Reassembling the Modem Board 57
 - Removal and Replacement 55
 - Removing a Password 50
 - RJ45 combo phone jack 21
 - RMA 105
 - S**
 - Security 48
 - Serial Port 19, 10
 - serial port
 - setting in Setup Utility 47
 - Setting a Password 50
 - Setup Utility 41, 41–53
 - Advanced menu 47
 - Boot Device Priority sub-menu 46

-
- CD-ROM submenu 45
 - entering 41
 - Exit menu 53
 - Hard Disk 0 submenu 44
 - Main menu 42
 - navigating 41
 - Power menu 51
 - Security menu 48
 - SGRAM 2
 - Simultaneous Display 2
 - sleep mode 29
 - software
 - bundled 31
 - Speaker-out jack 10
 - Speakers
 - Removal 72
 - speakers
 - hot key 9
 - Standby mode 28
 - entering 28
 - hot key 8
 - resuming from 28
 - signals 28
 - status indicator 4
 - status indicators 4
 - Stereo 20
 - Supervisor Password 36
 - S-video output 1
 - Symptom-to-FRU Index 89
 - System Specification 1
 - System Utilities 31
- T**
- Tag RAM 17
 - Test Compatible Components List 123
 - PCMCIA 124
 - Thermal Sensor Utility
 - Setting 97
 - Thin-Film-Transistor (TFT) 1
 - time
 - setting in Setup Utility 43
 - touchpad
 - hot key 9
 - Touchpad Bracket
 - Removal 73
 - TPM 127
 - Troubleshooting 81
- U**
- Undetermined Problems 96
 - Universal Serial Bus (USB) 1
 - Upper Case
 - Disassembly 70
 - User Password 37
 - utility
 - BIOS Setup 41–53
 - Notebook Manager 33–40
 - PhDISK 32
 - Utility Program Diskette 97
- V**
- V.17 fax modem 21
 - V.34 data modem 21
 - Video memory 18
 - Video Performance 2
 - voltage controller 20
- W**
- Wavetable synthesizer 1
 - Weights and Dimension 26
 - WfM 31
 - Windows 95 Keys 7
 - Windows keys 7
 - Windows logo key 7
- Y**
- Year2000 125
 - Compliance Test 126
 - PCMCIA Cards 125
- Z**
- Zoomed Video (ZV) 1
 - ZV (Zoomed Video) port 20

