

TravelMate 350

Service Guide

Service guide files and updates are available on the AIPG/CSD web; for more information, please refer to <http://csd.acer.com.tw>

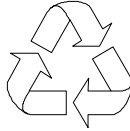

100% Recycled Paper

PART NO.: 49.45H02.001
DOC. NO.: SG348

PRINTED IN TAIWAN

Copyright

Copyright © 1999 by Acer Incorporated. All rights reserved. No part of this publication may be reproduced, transmitted, transcribed, stored in a retrieval system, or translated into any language or computer language, in any form or by any means, electronic, mechanical, magnetic, optical, chemical, manual or otherwise, without the prior written permission of Acer Incorporated.

Disclaimer

The information in this guide is subject to change without notice.

Acer Incorporated makes no representations or warranties, either expressed or implied, with respect to the contents hereof and specifically disclaims any warranties of merchantability or fitness for any particular purpose. Any Acer Incorporated software described in this manual is sold or licensed "as is". Should the programs prove defective following their purchase, the buyer (and not Acer Incorporated, its distributor, or its dealer) assumes the entire cost of all necessary servicing, repair, and any incidental or consequential damages resulting from any defect in the software.

Acer is a registered trademark of Acer Corporation.

Intel is a registered trademark of Intel Corporation.

Pentium and Pentium II/III are trademarks of Intel Corporation.

Other brand and product names are trademarks and/or registered trademarks of their respective holders.

Conventions

The following conventions are used in this manual:

Screen messages	Denotes actual messages that appear on screen.
NOTE	Gives bits and pieces of additional information related to the current topic.
WARNING	Alerts you to any damage that might result from doing or not doing specific actions.
CAUTION	Gives precautionary measures to avoid possible hardware or software problems.
IMPORTANT	Reminds you to do specific actions relevant to the accomplishment of procedures.

Preface

Before using this information and the product it supports, please read the following general information.

1. This Service Guide provides you with all technical information relating to the BASIC CONFIGURATION decided for Acer's "global" product offering. To better fit local market requirements and enhance product competitiveness, your regional office MAY have decided to extend the functionality of a machine (e.g. add-on card, modem, or extra memory capability). These LOCALIZED FEATURES will NOT be covered in this generic service guide. In such cases, please contact your regional offices or the responsible personnel/channel to provide you with further technical details.
2. Please note WHEN ORDERING FRU PARTS, that you should check the most up-to-date information available on your regional web or channel. If, for whatever reason, a part number change is made, it will not be noted in the printed Service Guide. For ACER-AUTHORIZED SERVICE PROVIDERS, your Acer office may have a DIFFERENT part number code to those given in the FRU list of this printed Service Guide. You MUST use the list provided by your regional Acer office to order FRU parts for repair and service of customer machines.

Chapter 1	System Specifications	1
	Features	1
	System Block Diagram	3
	Board Layout	4
	Panel	6
	Indicators	10
	Keyboard	11
	Touchpad	15
	Hardware Specifications and Configurations	17
Chapter 2	System Utilities	29
	BIOS Setup Utility	29
	BIOS Flash Utility	37
	System Utility Diskette	38
	System Diagnostic Diskette	39
Chapter 3	Machine Disassembly and Replacement	43
	General Information	44
	Disassembly Procedure Flowchart	45
	Removing the Battery Pack	47
	Removing the Hard disk drive Module	48
	Removing the DVD-ROM and Floppy disk drive Module	49
	Removing the Video Capture Kit	50
	Removing the Extended Memory	51
	Disassembling the LCD	52
	Removing the LAN Board	57
	Removing the Upper Case	58
	Removing the Lower Case	61
	System Upgrade Procedure	64
Chapter 4	Troubleshooting	69
	System Check Procedures	70
	Power-On Self-Test (POST) Error Message	73
Chapter 5	Jumper and Connector Information	83
	Top View	83
	Bottom View	85
Chapter 6	FRU (Field Replaceable Unit) List	87
Appendix A	Model Definition and Configuration	101
Appendix B	Test Compatible Components	103
	Microsoft Windows 98 Environment Test	104
	Microsoft Windows 2000 Environment Test	107
	Windows Millenium Environment Test	110
	Microsoft Windows NT Environment Test	113
Appendix C	Online Support Information	117
Index		119

Table of Contents

System Specifications

Features

This computer was designed with the user in mind. Here are just a few of its many features:

Performance

- Mobile Pentium® III 256 KB level 2 cache featuring Intel® SpeedStep™ technology
- 64-bit memory bus
- External EasyLink™ Combo Drive (floppy and CD-ROM/DVD-ROM drive)
- High-capacity, Enhanced-IDE hard disk
- Li-ion main battery pack
- Power management system with ACPI (Advanced Configuration Power Interface)
- Smart Card interface with pre-boot authentication systems as security feature.

Display

- 13.3" Thin-Film Transistor (TFT) liquid-crystal display (LCD) displaying 24-bit true-color at 1024x768 eXtended Graphics Array (XGA) resolution
- 4 MB to 8 MB Video DRAM, configurable through BIOS
- 3D capabilities
- Simultaneous LCD and CRT display support
- Supports other output display devices such as LCD projection panels for large-audience presentations
- "Automatic LCD dim" feature that automatically decides the best settings for your display and conserves power
- Dual display capability

Multimedia

- 16-bit high-fidelity AC'97 PCI stereo audio with wavetable synthesizer
- Built-in speaker with microphone
- Sound Blaster Pro and Windows Sound System-compatible
- High-speed CD-ROM or DVD-ROM drive
- USB video capture kit option

Connectivity

- High-speed fax/data modem port
- Fast infrared wireless communication
- USB (Universal Serial Bus) ports
- Ethernet/Fast Ethernet port
- IEEE 1394 port
- Smart Card interface socket
- Optional Bluetooth wireless communication feature
- Optional 802.11b wireless LAN

Human-centric design and ergonomics

- Sleek, smooth and stylish design
- Full-sized keyboard
- Ergonomically-centered touchpad pointing device
- Internet scroll key

Expansion

- One type II/I CardBus PC card (formerly PCMCIA) slot with ZV (zoomed video) port support
- Upgradeable memory
- EasyPort port replicator

System Block Diagram

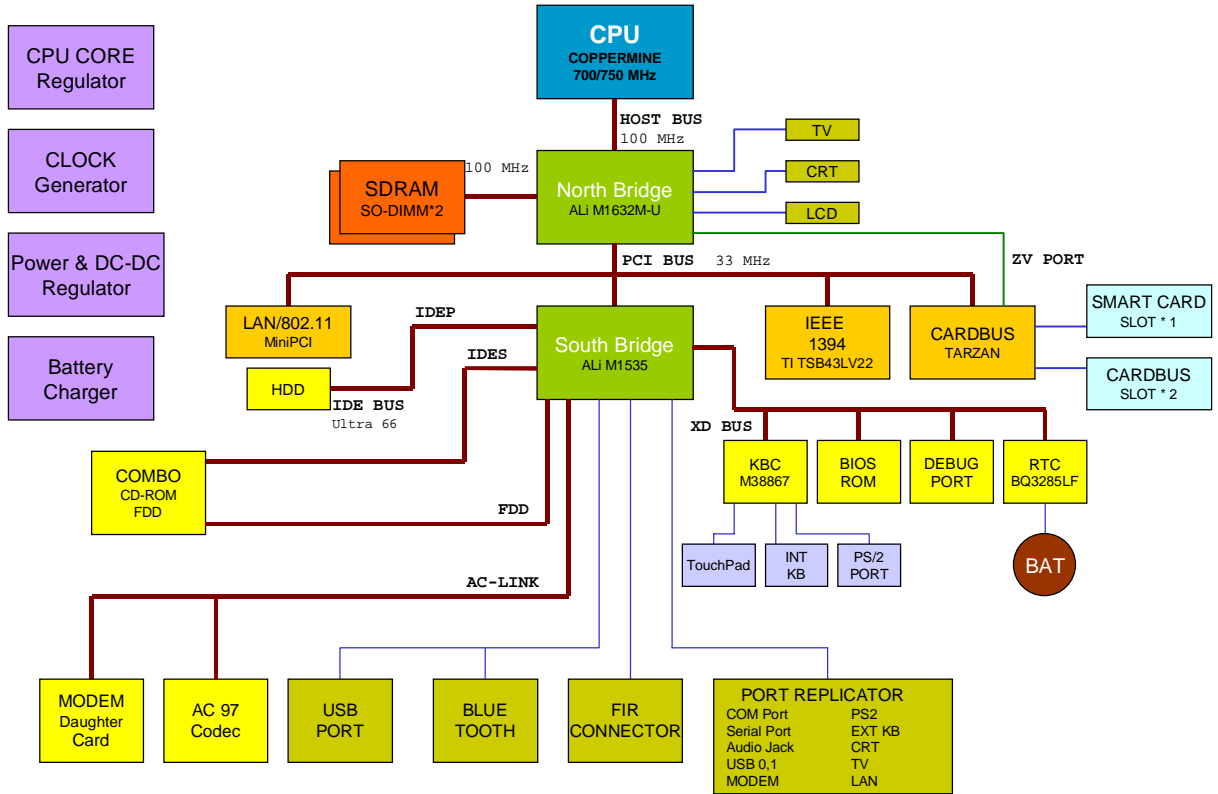

Board Layout

Top View

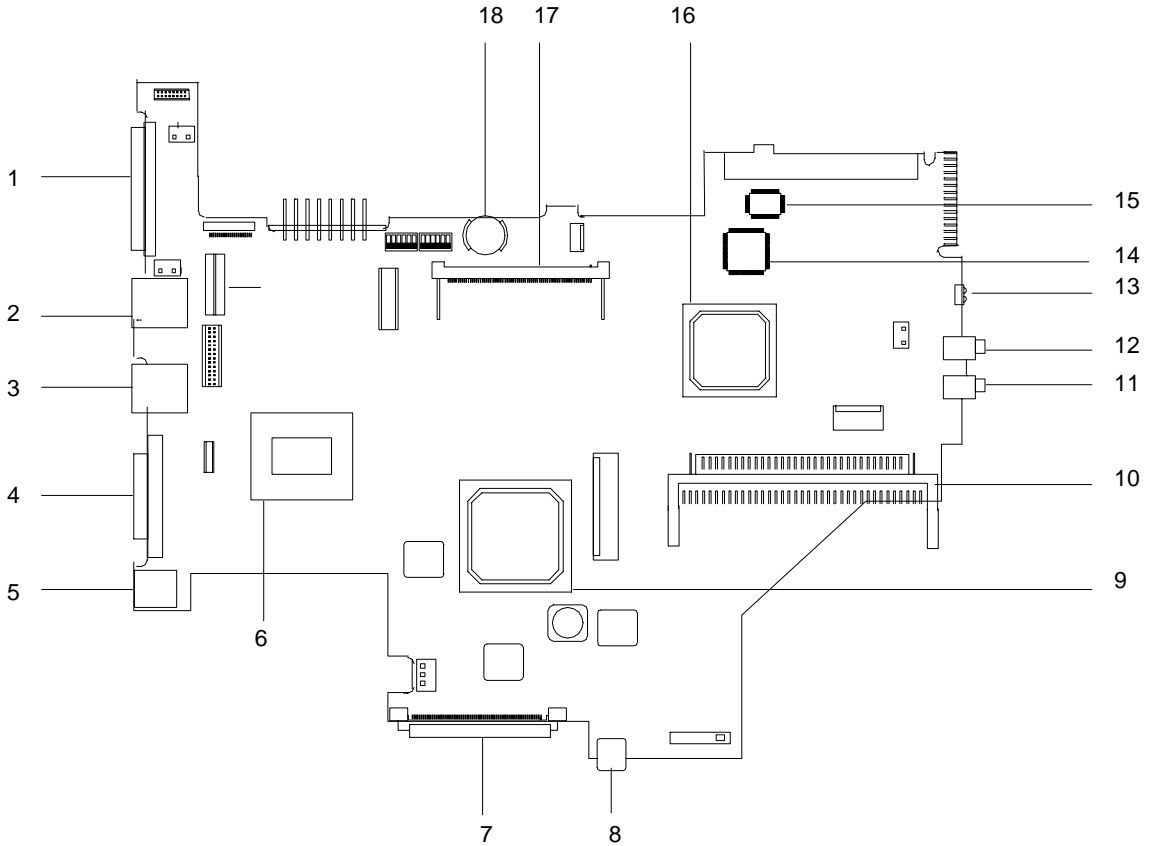

- | | |
|------------------------------|----------------------------------|
| 1. Expansion port | 10. PCMCIA socket connector |
| 2. Modem port | 11. Speaker/Headphone-out jack |
| 3. LAN port | 12. Line-in/external MIC jack |
| 4. External monitor port | 13. Infrared port |
| 5. DC-in port 1 | 14. Keyboard controller (M38867) |
| 6. Pentium III processor | 15. BIOS Flash ROM |
| 7. EasyLink Combo Drive port | 16. ALI M1535 South Bridge |
| 8. IEEE 1394 port | 17. Mini PCI socket |
| 9. ALI M1632 North Bridge | 18. RTC battery |

Bottom View

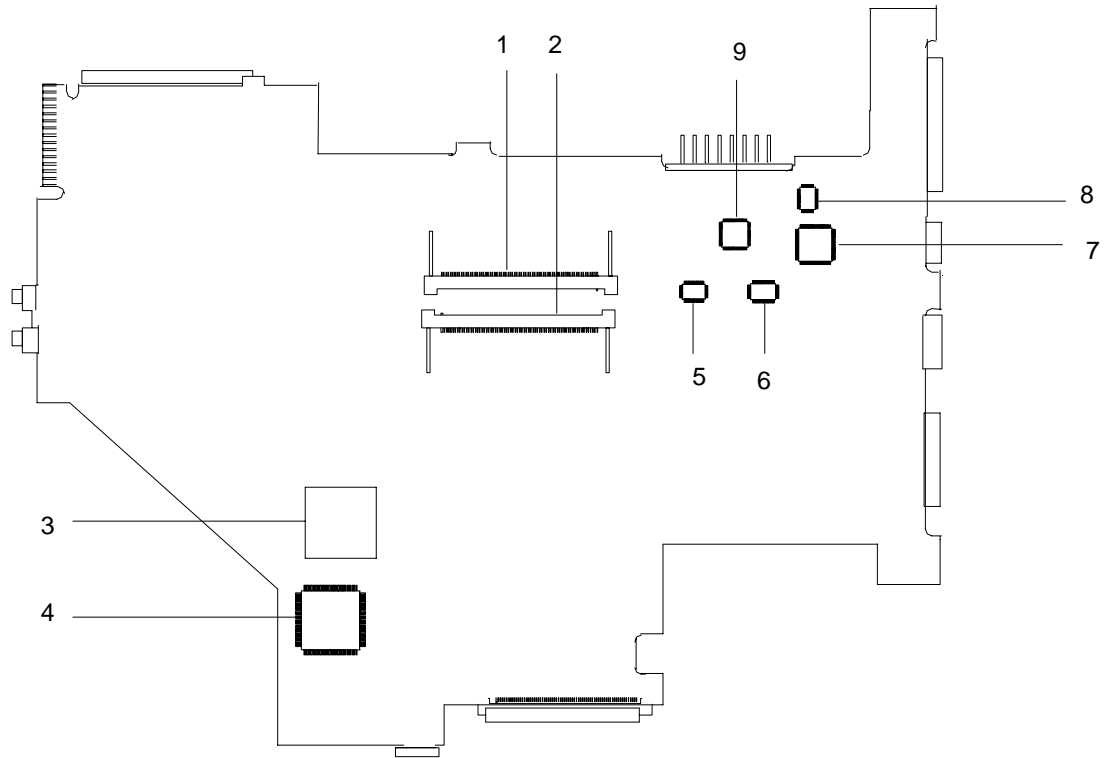





- 1. DIMM 1 socket
- 2. DIMM 2 socket (reverse)
- 3. CardBus controller
- 4. IEEE 1394 controller (TI TSB43LV22)
- 5. Clock buffer
- 6. Clock generator
- 7. TV controller
- 8. COM port controller
- 9. Geyserville controller

Panel

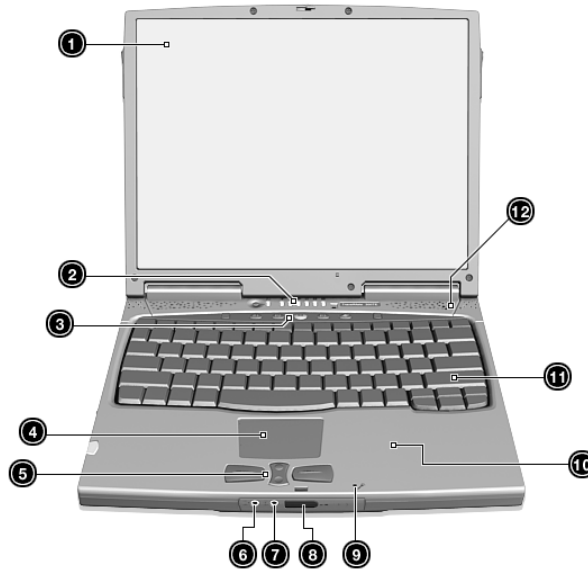
Ports allow you to connect peripheral devices to your computer as you would with a desktop PC.

Front view



#	Item	Description
1	Display screen	Also called LCD (liquid-crystal display), displays computer output.
2	Status indicators	LEDs (light-emitting diodes) that turn on and off to show the status of the computer and its functions and components.
3	Launch keys	Buttons for launching frequently used programs. See "Launch Keys" on page 14 for more details.
4	Touchpad	Touch-sensitive pointing device which functions like a computer mouse.
5	Click buttons (left, center and right)	The left and right buttons function like the left and right mouse buttons; the center button serves as a scroll up/down button.
6	Speaker/Headphone-out jack 	Connects to audio line-out devices (e.g., speakers, headphones).
7	Line-in jack 	Accepts audio line-in devices (e.g., audio CD player, stereo walkman).
8	Infrared port 	Interfaces with Infrared devices (e.g., infrared printer, IR-aware computers).
9	Microphone 	Inputs sounds and voices into your computer.
10	Palmrest	Comfortable support area for your hands when you use the computer.

#	Item	Description
11	Keyboard	Inputs data into your computer.
12	Speaker	Outputs sound.

Left view

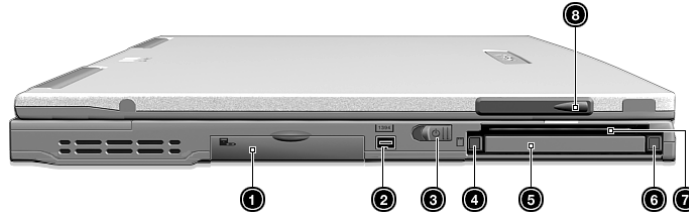

#	Item	Description
1	EasyLink Combo Drive connector	Connects to an EasyLink Combo Drive.
2	IEEE 1394 port	Connects to any IEEE 1394 supported devices.
3	Power switch	Turns on the computer power.
4	PC Card eject button	Ejects PC Card from the card slot.
5	PC Card slot 	Connects to one Type II 16-bit PC Card or 32-bit CardBus PC Card.
6	SmartCard eject button	Ejects SmartCard from the card slot.
7	Smart card slot	Slot for Smart Card interface with pre-boot authentication systems.
8	Video capture kit slot	Accepts the video capture kit option on the left side of the computer.



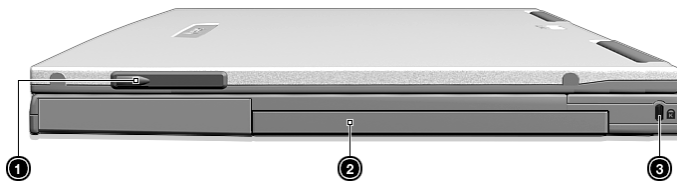



Right view

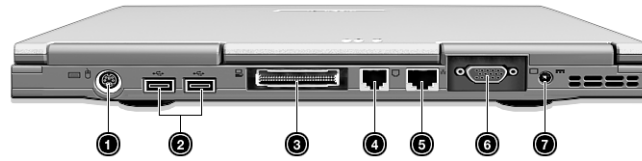

#	Item	Description
1	Video capture kit slot	Accepts the video capture kit option on the right side of the computer.
2	Battery bay	Houses the computer's battery pack.
3	Security keylock	Connects to a Kensington-compatible key-based computer security lock.

Rear view



#	Item	Description
1	PS/2 port 	Connects to any PS/2-compatible device (e.g., PS/2 keyboard/mouse/keypad).
2	USB ports (two) 	Connect to any Universal Serial Bus devices (e.g., USB mouse, USB camera).
3	Expansion port 	I/O replicator or EasyPort expansion devices.
4	Modem jack 	Connects to a phone line.
5	Network jack 	Connects to an Ethernet 10/100-based network
6	External display port 	Connects to a display device (e.g., external monitor, LCD projector) and displays up to 64K colors at 1280x1024 resolution.
7	Power jack 	Connects to an AC adapter.

Bottom view

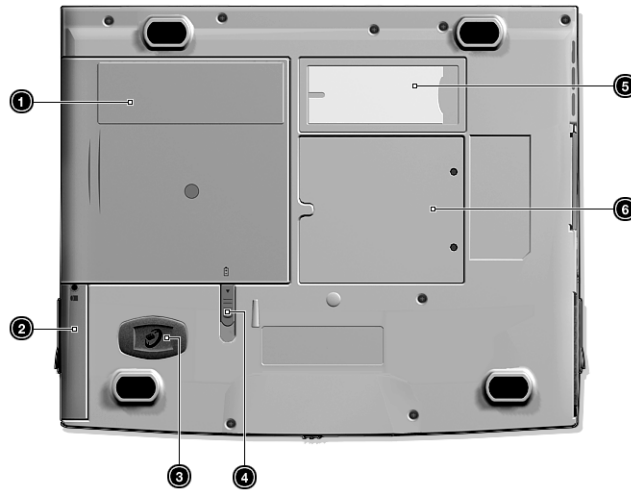





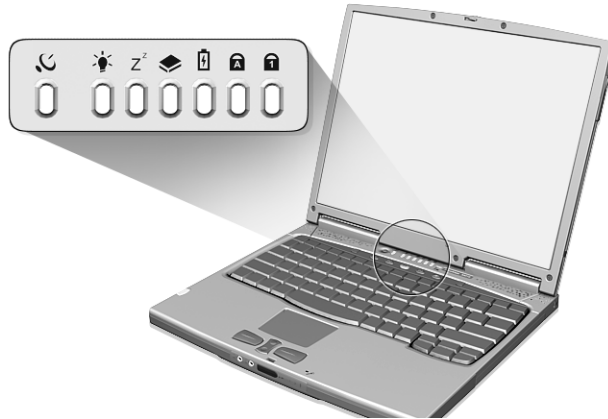

#	Item	Description
1	Battery bay	Houses the computer's battery pack.
2	Hard disk bay	Houses the computer's hard disk (secured by a screw).
3	Hard disk anti-shock protection	Protects your hard disk against shocks.
4	Battery release latch	Unlatches the battery to remove the battery pack.
5	Personal identification slot	Insert a business card or similar-sized identification card to personalize your computer.
6	Memory compartment	Houses the computer's main memory.

Indicators

The computer has seven easy-to-read status icons below the display screen.



The Power and Sleep status icons are visible even when you close the display cover so you can see the status of the computer while the cover is closed.

Icon	Function	Description
	Wireless Communication	Lights when the Blue Tooth/Wireless LAN capabilities are enabled.
	Power	Lights when the computer is on.
	Sleep	Lights when the computer enters Sleep mode.
	Media Activity	Lights when the floppy drive, hard disk or EasyLink Combo drive is active.
	Battery Charge	Lights when the battery is being charged.
	Caps Lock	Lights when Caps Lock is activated.
	Num Lock	Lights when Num Lock is activated.

Keyboard

The keyboard has full-sized keys and an embedded keypad, separate cursor keys, two Windows keys and twelve function keys.

Special keys

Lock keys

The keyboard has three lock keys which you can toggle on and off.



Lock key	Description
Caps Lock	When Caps Lock is on, all alphabetic characters typed are in uppercase.
Num Lock (Fn-F11)	When Num Lock is on, the embedded keypad is in numeric mode. The keys function as a calculator (complete with the arithmetic operators +, -, *, and /). Use this mode when you need to do a lot of numeric data entry. A better solution would be to connect an external keypad.
Scroll Lock (Fn-F12)	When Scroll Lock is on, the screen moves one line up or down when you press the up or down arrow keys respectively. Scroll Lock does not work with some applications.

NOTE: To access the Num Lock and Scroll Lock functions, hold the Fn key down while pressing the F11 and F12 keys respectively.

Embedded numeric keypad

The embedded numeric keypad functions like a desktop numeric keypad. It is indicated by small characters located on the upper right corner of the keycaps. To simplify the keyboard legend, cursor-control key symbols are not printed on the keys.











Desired access	Num lock on	Num lock off
Number keys on embedded keypad	Type numbers in a normal manner.	
Cursor-control keys on embedded keypad	Hold Shift while using cursor-control keys.	Hold Fn while using cursor-control keys.
Main keyboard keys	Hold Fn while typing letters on embedded keypad.	Type the letters in a normal manner.

NOTE: If an external keyboard or keypad is connected to the computer, the Num Lock feature automatically shifts from the internal keyboard to the external keyboard or keypad.

Windows keys

The keyboard has two keys that perform Windows-specific functions.



Key	Description
Windows logo key 	Start button. Combinations with this key perform shortcut functions. Below are a few examples: <ul style="list-style-type: none">  + Tab (Activates next taskbar button)  + E (Explores My Computer)  + F (Finds Document)  + M (Minimizes All) Shift +  + M (Undo Minimize All)  + R (Displays the Run... dialog box)
Application key 	Opens a context menu (same as a right-click).

Hot keys

The computer employs hot keys or key combinations to access most of the computer's controls like screen brightness, volume output and the BIOS Utility.

To activate hot keys, press and hold the **Fn** key before pressing the other key in the hot key combination.



Hot key	Icon	Function	Description
Fn-F1	?	Hot Key Help	Displays help on hot keys.
Fn-F2		Setup	Accesses the computer's configuration utility.
Fn-F3		Power Management Scheme Toggle	Switches the power management scheme used by the computer (function available if supported by operating system).
Fn-F4	Zz	Sleep	Puts the computer in Sleep mode.
Fn-F5		Display Toggle	Switches display output between the display screen, external monitor (if connected) and both the display screen and external monitor.
Fn-F6		Screen Blank	Turns the display screen backlight off to save power. Press any key to return.
Fn-F7		Touchpad Toggle	Turns the internal touchpad on and off.
Fn-F8		Speaker Toggle	Turns the speakers on and off.
Fn-↑		Volume up	Increases the speaker volume.
Fn-↓		Volume down	Decreases the speaker volume.
Fn-→		Brightness up	Increases the screen brightness.
Fn-←		Brightness down	Decreases the screen brightness.
Alt Gr-Euro	€	Euro	Types the Euro symbol (available on some models).

The Euro symbol

If your keyboard layout is set to United States-International or United Kingdom or if you have a keyboard with a European layout, you can type the Euro symbol on your keyboard.

NOTE: For US keyboard users: The keyboard layout is set when you first set up Windows. For the Euro symbol to work, the keyboard layout has to be set to United States-International.

To verify the keyboard type:

1. Click on **Start, Settings, Control Panel**.
2. Double-click on **Keyboard**.
3. Click on the **Language** tab.
4. Verify that the keyboard layout used for "English (United States)" is set to United States-International.
5. If not, select and click on **Properties**; then select **United States-International** and click on **OK**.
6. Click on **OK**.

To type the Euro symbol:

1. Locate the Euro symbol on your keyboard.
2. Open a text editor or word processor.
3. Hold **Alt Gr** and press the Euro symbol.

NOTE: Some fonts and software do not support the Euro symbol. Please refer to <http://www.microsoft.com/typography/faq/faq12.htm> for more information.

Launch Keys

Located at the top of the keyboard are five buttons. These buttons are called launch keys. They are designated as P1, P2, P3, mail button and Web browser button. By default, buttons P1 and P2 are users programmable. The mail button is used to launch the e-mail application. The LED of the mail button will flash when the user has received an incoming e-mail. The P3, by default is used to launch a multimedia application that came bundled with your system. The Web browser button, by default, is used to launch your Internet browser.



Touchpad

The built-in touchpad is a PS/2-compatible pointing device that senses movement on its surface. This means the cursor responds as you move your finger on the surface of the touchpad. The central location on the palm rest provides optimum comfort and support.

NOTE: When using an external USB or serial mouse, you can press **Fn-F7** to disable the touchpad. If you are using an external PS/2 mouse, the touchpad is automatically disabled.



Touchpad basics

The following items teach you how to use the touchpad:

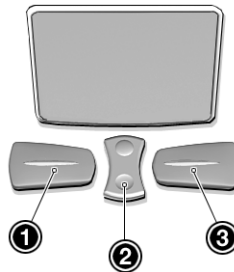

- Move your finger across the touchpad to move the cursor.
- Press the left (1) and right (3) buttons located on the edge of the touchpad to do selection and execution functions. These two buttons are similar to the left and right buttons on a mouse. Tapping on the touchpad produces similar results.
- Use the center (2) button (top and bottom) to scroll up or down a page. This button mimics your cursor pressing on the right scroll bar of Windows applications.

Function	Left button	Right button	Center buttons	Tap
Execute	Click twice quickly			Tap twice (at the same speed as double-clicking a mouse button)
Select	Click once			Tap once
Drag	Click and hold, then use finger to drag the cursor on the touchpad			Tap twice (at the same speed as double-clicking a mouse button) then hold finger to the touchpad on the second tap and drag the cursor
Access context menu		Click once		

Function	Left button	Right button	Center buttons	Tap
Scroll			Click and hold the up/down button	

NOTE: Keep your fingers dry and clean when using the touchpad. Also keep the touchpad dry and clean. The touchpad is sensitive to finger movements. Hence, the lighter the touch, the better the response. Tapping harder will not increase the touchpad's responsiveness.

Hardware Specifications and Configurations

Main board Major Chips

Item	Controller
System core logic	ALI Aladdin Pro II chipset M1632/M1535
Super I/O controller	Built in M1535
Audio controller	Built in M1535
Video controller	Built in M1632 (Trident CyberBlade AGP-2X)
IDE controller	Built in M1535 (2-channel dedicated Ultra-66 IDE Master Controller)
Keyboard controller	Mitsubishi M38867
RTC	BenchMark BQ3285LF SSOP
PCMCIA controller	O2 Micro OZ711 CardBus controller (Tarzan)
IEEE 1394 controller	TI TSB43LV22

Processor

Item	Specification
CPU type	Intel Pentium III 650/700 MHz processor with 256KB L2 on-die cache memory
CPU package	BGA package
CPU core voltage	1.6V/1.35V
CPU I/O voltage	1.5V

BIOS

Item	Specification
BIOS vendor	Acer
BIOS version	V3.3
BIOS ROM type	Flash ROM
BIOS ROM size	512KB
BIOS package	32-pin TSOP
Supported protocols	ACPI 1.0b, HDD Password, Int 13h Extensions, S4BIOS for Win98, PnP BIOS 1.0a, SMBIOS 2.3, Simple Boot Flag 1.0, PCI 2.1 USB specification 1.0., PCI Bus Power Management interface Specification, Boot Block, SMI 1.2, EPP/IEEE 1284, ECP/IEEE 1284 1.7 & 1.9, IrDA, PS/2 keyboard and mouse, VESA VGA BIOS, DDC-2B, CD-ROM bootable
BIOS password control	Set by switch, see SW3 settings

Second Level Cache

Item	Specification
Cache controller	Built-in CPU
Cache size	256KB
1st level cache control	Always enabled
2nd level cache control	Always enabled
Cache scheme control	Fixed in write-back

System Memory

Item	Specification
Memory controller	Built-in ALI M1632
Onboard memory size	0MB
DIMM socket number	2 sockets
Supports memory size per socket	64/128 MB
Supports maximum memory size	256MB (128MB x 2)
Supports DIMM type	SDRAM
Supports DIMM speed	100MHz
Supports DIMM voltage	3.3V
Supports DIMM package	144-pin SO-DIMM
Memory module combinations	You can install memory modules in any combinations as long as they match the above specifications.

Memory Combinations

Slot 1	Slot 2	Total Memory
0 MB	64 MB	64 MB
64 MB	64 MB	128 MB
0 MB	128 MB	128 MB
64 MB	128 MB	192 MB
128 MB	128 MB	256 MB

Above table lists some system memory configurations. You may combine DIMMs with various capacities to form other combinations.

NOTE: The shipping specification for DIMM combination is 64MB in slot 1.

LAN Interface

Item	Specification
LAN Interface/Chipset	Mini PCI interface LAN card / Intel 82559 chipset
Supports LAN protocol	10/100 Mbps
LAN connector type	RJ45
LAN connector location	Rear side

Wireless LAN Interface

Item	Specification
LAN Interface	Mini PCI interface IEEE 802.11a LAN card
Channel support and default channel protocol	Covering the FCC subset of the IEEE802.11b ISM Band
Enable/disable radio	Support FAA requirement

Modem Interface

Item	Specification
Modem Interface/Chipset	Built in M1535 AC'97 2.1 compliant digital controller interface with software modem solution / Ambit U98M005.01
Fax modem data baud rate (bps)	14.4K
Data modem data baud rate (bps)	56K
Supports modem protocol	V.90 data modem 56K, V.90 fax modem 14.4K and digital line protection operation
Modem connector type	RJ11
Modem connector location	Rear side

Hard Disk Drive Interface

Item	Specification		
Vendor & Model Name	IBM DJSA-205	IBM DJSA-210	IBM DJSA-220
Capacity (GB)	5	10	20
Bytes per sector	512	512	512
Logical heads	15	16	16
Logical sectors	63	63	63
Drive Format			
Logical cylinders	13424	16383	16383
Physical read/write heads	1	2	4
Disks	1	1	2
Spindle speed (RPM)	4200	4200	4200
Performance Specifications			
Buffer size (KB)	418	418	418
Interface	IDE (ATA-4)	IDE (ATA-4)	IDE (ATA-4)
Data transfer rate (disk buffer, MB/s)	85.5-161.6	85.5-161.6	85.5-161.6
Data transfer rate (host buffer, MB/s)	16.6 (PIO Mode-4) 66.6 (Ultra DMA Mode-4)	16.6 (PIO Mode-4) 66.6 (Ultra DMA Mode-4)	
DC Power Requirements			
Voltage tolerance	5+/-5%	5+/-5%	5+/-5%

CD-ROM/Floppy Diskette Combo Drive Interface

Item	Specification
Vendor & model name	TEAC CF240500
CD-ROM	
Performance Specification	
Transfer rate (KB/sec)	1,545KB/sec ~ 3,600KB/sec. (FULL - CAV)
Access time (typ.)	130 ms
Rotation speed	5136 rpm (typ.)
Buffer memory	128 KB
Interface	ATAPI
Applicable disc format	CD-DA, CD-ROM (Mode-1, Mode-2), CD-ROM XA MODE-2 (FORM-1, FORM-2), Multi-Session Photo CD, CD-I, Video CD, Enhanced CD & CD PLUS Compatible, CD-R/W

CD-ROM/Floppy Diskette Combo Drive Interface

Item	Specification		
Loading mechanism	Drawer with soft eject and emergency eject hole		
Power Requirement			
Input Voltage	5 V		
Floppy disk drive			
Floppy disk Specifications			
Media recognition	2DD (720KB)	2HD (1.2MB, 3-mode)	2HD (1.44MB)
Sectors / track	9	15	18
Tracks	80	80	80
Data transfer rate (Kbit/s)	250	500	500
Rotational speed (RPM)	300	360	300
Read/write heads	2		
Encoding method	MFM		
Power Requirement			
Input Voltage (V)	+5V +-10%		

DVD-ROM/Floppy Diskette Combo Drive Interface

Item	Specification		
Vendor & model name	Addonics MKE SR8175		
DVD-ROM			
Performance Specification	With CD Diskette	With DVD Diskette	
Transfer rate (KB/sec)	1,500KB/sec ~ 3,600KB/sec. (FULL - CAV)	4.58MB/sec ~ 11.08MB/sec. (FULL - CAV)	
Access time (typ.)	110 ms	150 ms	
Rotation speed	4800 rpm (typ.)	3700 rpm (typ.)	
Buffer memory	512 KB	512 KB	
Interface	ATAPI		
Applicable disc format	DVD-ROM, DVD-Video, CD-DA, CD-ROM (Mode-1, Mode-2), CD-ROM XA MODE-2 (FORM-1, FORM-2), Multi-Session Photo CD, CD-I, Video CD, Enhanced CD & CD PLUS Compatible, CD-R/W		
Loading mechanism	Drawer with soft eject and emergency eject hole		
Power Requirement			
Input Voltage	5 V		
Floppy disk drive			
Floppy disk Specifications			
Media recognition	2DD (720KB)	2HD (1.2MB, 3-mode)	2HD (1.44MB)
Sectors / track	9	15	18
Tracks	80	80	80
Data transfer rate (Kbit/s)	250	500	500
Rotational speed (RPM)	300	360	300
Read/write heads	2		
Encoding method	MFM		
Power Requirement			
Input Voltage (V)	+5V +-10%		

Audio Interface

Item	Specification
Audio controller	Built in M1535 audio controller combined with standard AC97/AC98 codec (Cirrus CS-4299)
Audio onboard or optional	Onboard
Mono or Stereo	Stereo
Resolution	16 bit
Compatibility	Windows Sound System (WSS), Microsoft PC98/PC99, WHQL audio requirement
Mixed sound source	Voice, Synthesizer, Line-in, Microphone, CD
Voice channel	6/16-bit, mono/stereo
Sampling rate	48 KHz
Internal microphone	Yes
Internal speaker / Quantity	Yes/ 1 pieces
Supports PnP DMA channel	DMA channel 0 DMA channel 1
Supports PnP IRQ	IRQ3, IRQ5, IRQ7, IRQ9, IRQ10, IRQ11

Video Interface

Item	Specification
Vendor & model name	Built in M1632 (Trident CyberBlade AGP-2X)
Chip voltage	Core/2.5V Memory/3.3V
Supports ZV (Zoomed Video) port	Yes
Graph interface	2X AGP (Accelerated Graphics Port) bus
Maximum resolution (LCD)	1024x768 (24 bit colors)
Maximum resolution (CRT)	1024x768 (24 bit colors)

Video Memory

Item	Specification
Fixed or upgradeable	Share with system memory
Video memory size	4 or 8 MB

Video Resolutions Mode

Resolution	Refresh Rate	
	CRT Only	LCD/CRT Simultaneous
640x480x256	85	60
640x480x64K	85	60
640x480x16M	85	60
800x600x256	85	60
800X600X64K	85	60
1024x768x256	60, 75	60

USB Port

Item	Specification
USB Compliance Level	1.0
OHCI	USB 1.0
Number of USB port	2
Location	Rear side
Serial port function control	Enable/Disable by BIOS Setup

IrDA Port

Item	Specification
IrDA FIR port controller	Built in M1535
Number of IrDA FIR port	1
Location	Front side
IrDA FIR port function control	Enable/disable by BIOS Setup
Optional IrDA FIR port (in BIOS Setup)	2F8h, 3F8h, 3E8h, 2E8h
Optional IrDA FIR port IRQ (in BIOS Setup)	IRQ3, IRQ4, IRQ10, IRQ11
Optional IrDA FIR port DRQ (in BIOS Setup)	DRQ3, DRQ1, DRQ0

PCMCIA Port

Item	Specification
PCMCIA controller	O2 Micro OZ711 CardBus controller (Tarzan)
Supports card type	Type II/I
Number of slots	One for smart card (upper) One type II/I (lower)
Access location	Left side
Supports ZV (Zoomed Video) port	Yes
Supports 32 bit CardBus	Yes

Keyboard

Item	Specification
Keyboard controller	Mitsubishi M38867
Keyboard vendor & model name	Darfon NSK-A3001
Total number of keypads	84/85/88-key
Windows 95 keys	Yes
Internal & external keyboard work simultaneously	Yes

Battery

Item	Specification
Vendor & model name	Sanyo 3UF103450P-2
Battery Type	Li-ion
Pack capacity	1650 mA

Battery

Item	Specification
Cell voltage	3.6V
Number of battery cell	6
Package configuration	3S-2P
Package voltage	11V

DC-AC LCD Inverter

Item	Specification
Vendor & model name	Ambit T62I174.00 & Sumida IV003 (IV15090/T)
Input voltage (V)	+5V
Input current (mA)	200mA max
Output voltage (Vrms, no load)	1300Vrms
Output voltage frequency (kHz)	60K-65K Hz
Output Current/Lamp	6.0 mA max

NOTE: DC-AC inverter is used to generate very high AC voltage, then support to LCD CCFT backlight user, and is also responsible for the control of LCD brightness. Avoid touching the DC-AC inverter area while the system unit is turned on.

NOTE: There is an EEPROM in the inverter, which stores its supported LCD type and ID code. If you replace a new inverter or replace the LCD with a different brand, use Inverter ID utility to update the ID information.

LCD

Item	Specification
Vendor & model name	LG LP133X8
Mechanical Specifications	
LCD display area (diagonal, inch)	13.3
Display technology	TFT
Resolution	XGA, 1024x768
Supports colors	262K
Optical Specification	
Brightness control	keyboard hotkey
Contrast control	No
Electrical Specification	
Supply voltage for LCD display (V)	3.3
Supply voltage for LCD backlight (Vrms)	630

AC Adapter

Item	Specification	
Vendor & model name	Lite-On PA-1600-02	Delta ADP-60DB
Input Requirements		
Maximum input current (A, @90Vac, full load)	1.5 A @ 90Vac 0.9 A @ 180Vac	1.5 A @ 90Vac 0.9 A @ 180Vac
Nominal frequency (Hz)	47 - 63	47 - 63

AC Adapter

Item	Specification	
Frequency variation range (Hz)	47 - 63	47 - 63
Nominal voltages (V)	90 - 264	90 - 264
Inrush current	The maximum inrush current will be less than 50A and 100A when the adapter is connected to 115Vac(60Hz) and 230Vac(50Hz) respectively.	The maximum inrush current will be less than 50A and 100A when the adapter is connected to 115Vac(60Hz) and 230Vac(50Hz) respectively.
Efficiency	It should provide an efficiency of 83% minimum, when measured at maximum load under 115V(60Hz).	It should provide an efficiency of 83% minimum, when measured at maximum load under 115V(60Hz).
Output Ratings (CV mode)		
DC output voltage	19 +0.6/-0 V	19 +0.6/-0 V
Noise + Ripple	300m Vp-p max (20MHz bandwidth)	300m Vp-p max (20MHz bandwidth)
Load	0 A (min.) 3.16 A (max.)	0 A (min.) 3.16 A (max.)
Output Ratings (CC mode)		
DC output voltage	+12V ~ +19V	+12V ~ +19V
Constant output	2.75 ± 0.2 A	2.75 ± 0.2 A
Dynamic Output Characteristics		
Turn-on delay time	2 sec. (@115Vac)	2 sec. (@115Vac)
Hold up time	4 ms min. (@115 Vac input, full load)	4 ms min. (@115 Vac input, full load)
Over Voltage Protection (OVP)	24 V	24 V
Short circuit protection	Output can be shorted without damage	Output can be shorted without damage
Electrostatic discharge (ESD)	15kV (at air discharge) 8kV (at contact discharge)	15kV (at air discharge) 8kV (at contact discharge)
Dielectric Withstand Voltage		
Primary to secondary	1500 Vac (or 2121 Vdc), 10 mA for 1 second	1500 Vac (or 2121 Vdc), 10 mA for 1 second
Leakage current	0.25 mA max. (@ 254 Vac, 60Hz)	0.25 mA max. (@ 254 Vac, 60Hz)
Regulatory Requirements	Internal filter meets: 1. FCC class B requirements. (USA) 2. VDE 243/1991 class B requirements. (German) 3. CISPR 22 Class B requirements. (Scandinavia) 4. VCCI class II requirements. (Japan)	Internal filter meets: 1. FCC class B requirements. (USA) 2. VDE 243/1991 class B requirements. (German) 3. CISPR 22 Class B requirements. (Scandinavia) 4. VCCI class II requirements. (Japan)

Power Management

Power Saving Mode	Phenomenon
Standby Mode <ul style="list-style-type: none"> <input type="checkbox"/> Waiting time specified by the System Standby value or the operating system elapses without any system activity. <input type="checkbox"/> Closing the display cover <input type="checkbox"/> When the computer is about to enter Hibernation mode (e.g., during a battery-low condition), but the Hibernation file is invalid or not present. <input type="checkbox"/> When customized functions for power management are set to Standby and the corresponding action is taken. <input type="checkbox"/> Invoked by the operating system power-saving modes. 	<ul style="list-style-type: none"> <input type="checkbox"/> The buzzer beeps <input type="checkbox"/> The Sleep indicator lights up
Hibernation Mode <ul style="list-style-type: none"> <input type="checkbox"/> When customized functions for power management are set to Hibernation and the corresponding action is taken. <input type="checkbox"/> Invoked by the operating system power-saving modes. 	<ul style="list-style-type: none"> <input type="checkbox"/> All power shuts off
Display Standby Mode Keyboard, built-in touchpad, and an external PS/2 pointing device are idle for a specified period.	<ul style="list-style-type: none"> <input type="checkbox"/> The display shuts off
Hard Disk Standby Mode Hard disk is idle within a specified period of time.	<ul style="list-style-type: none"> <input type="checkbox"/> Hard disk drive is in standby mode. (spindle turned off)

Environmental Requirements

Item	Specification
Temperature	
Operating	+5 ~ +35°C
Non-operating	-10 ~ +60°C
Non-operating	-20 ~ +60°C (storage package)
Humidity	
Operating	20% ~ 80% RH, non-condensing
Non-operating	20% ~ 90% RH, non-condensing (Unpacked)
Non-operating	20% ~ 90% RH, non-condensing (storage package)
Vibration	
Operating (unpacked)	5 ~ 25.6 Hz: 0.38mm (peak to peak) 25.6 ~ 250 Hz: 0.5G
Non-operating (unpacked)	5 ~ 27.1 Hz: 0.6G 27.1 Hz ~ 50 Hz: 0.4mm (peak to peak) 50 ~ 500 Hz: 2.0G
Non-operating (packed)	5 ~ 62.6 Hz: 0.51mm (peak to peak) 62.6 Hz ~ 500 Hz: 4G

Mechanical Specifications

Item	Specification
Dimensions	289mm (W) x 219mm (D) x 23mm (H)
Weight	1.816 kg (4 lbs) (including battery)
I/O Ports	One type II/ I PCMCIA (PC card) port, one Smart Card port, one IEEE 1394 port, one EasyLink Combo Drive connector, one RJ11 port, one RJ-45 port, one DC-in port, one infrared (FIR) port, two USB ports, one external display port, one PS/2 keyboard/mouse port, one line-out jack, one line-in jack, one expansion port
Drive Bays	One
Material	LCD Panel & Lower Case: Meg-Alloy Others of Housing: Plastic
Indicators	Wireless Communication LED, Power LED, Sleep LED, Media Activity LED, Battery Charge LED, Caps Lock LED, Num Lock LED
Switch	Power

Memory Address Map

Memory Address	Size	Function
00000000-0009FFFF	640 KB	Base memory
000A0000-000BFFFF	128 KB	Video memory
000C0000-000C9FFF	40 KB	Video BIOS
000CA000-000CBFFF	8 KB	I/O ROM
000E0000-000FFFFF	128 KB	System BIOS
00100000-top limited	--	Extended (DIMM) memory
04301000-04301FFF	4 KB	PCMCIA controller (slot 1)
04302000-04302FFF	4 KB	PCMCIA controller (slot 2)
04300000-04300FFFF	64 KB	USB controller

I/O Address Map

I/O Address	Function
000-00F	DMA controller-1
020-021	Interrupt controller-1
040-043	Timer 1
060, 064	Keyboard controller 8742 chip select
061, 066	System speaker, ACPI embedded controller
040B	DMA controller-1
061	System speaker
070-073	System CMOS/real-time clock
080-08F	DMA page register
0A0-0A1	Interrupt controller-2
0C0-0DF	DMA controller-2
0F0-0FF	Numeric data processor
104-10B	Lucent tech. soft modem AMR
120-13F 180-18F	Power management controller
170-177	2nd EIDE device (CD-ROM) select
1F0-1F7	1st EIDE device (hard drive) select

I/O Address Map

I/O Address	Function
220-22F	Audio
240-24F	Audio (optional)
278-27F	Parallel port 3
2E8-2EF	COM4
2F8-2FF	COM2 or FIR (optional)
376, 3F6	ALi M5229 PCI BusMaster IDE controller
3BC-3BF	Parallel port 1
3B0-3BB 3C0-3DF	Video Controller
3F0h-3F7	Standard Floppy Disk Controller
3E8-3EF	ALi fast IR controller
3F0-3F5, 3F7	Floppy disk controller
3F8-3FF	COM1
480-48F, 4D6	DMA controller-1
4D0-4D1 CF8-CFF	PCI configuration register

IRQ Assignment Map

Interrupt Channel	Function
IRQ0	System timer
IRQ1	Standard 101/102-key or Microsoft natural keyboard.
IRQ2	Programmable Interrupt Controller
IRQ3	IrDA Fast Interrupt Port
IRQ4	COM1
IRQ5	Reserve
IRQ6	Floppy Disk Controller
IRQ7	Printer Port (LPT1)
IRQ8	System CMOS/real time clock
IRQ9	SCI IRQ used by ACPI bus
IRQ10	ALi audio accelerator WDM driver Lucent Technologies SoftModem AMR 1394 host controller
IRQ11	PCMCIA CardBus Controller O2Micro Smart CardBus reader Trident CyberBlade Ai1 AGP ALi PCI to USB Open Host Controller
IRQ12	PS2 pointing device
IRQ13	Numeric data processor
IRQ14	1st EIDE device
IRQ15	2nd EIDE device

DMA Channel Assignment

DMA Channel	Function
DRQ0	Not Used
DRQ1	Not Used
DRQ2	Floppy Disk Controller

DMA Channel Assignment

DMA Channel	Function
DRQ3	IrDA Fast Infrared Port
DRQ4	Direct memory access controller
DRQ5	Not Used
DRQ6	Not Used
DRQ7	Not Used

System Utilities

BIOS Setup Utility

The BIOS Setup Utility is a hardware configuration program built into your computer's BIOS (Basic Input/Output System).

Your computer is already properly configured and optimized, and you do not need to run this utility. However, if you encounter configuration problems, you may need to run Setup. Please also refer to Chapter 4 Troubleshooting when problem arises.

To activate the BIOS Utility, press **F2** during POST (while the TravelMate logo is being displayed).

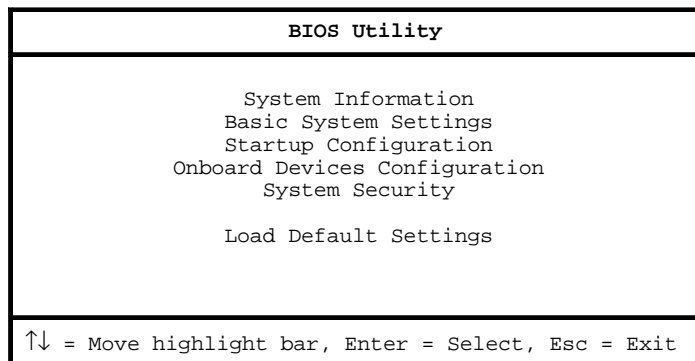

Navigating the BIOS Utility

There are six menu options. Use the cursor up/down keys to select a menu item, then press Enter. After you enter a sub-menu, you can:

- Use the **cursor up/down** keys to move between the parameters.
- Use the **cursor left/right** keys to change the value of a parameter.

You can change the value of a parameter if it is enclosed in square brackets.

- Press **Esc** to exit the current sub-menu.

At the main menu, press **Esc** to exit the BIOS Utility. If you make any changes, the following dialog box displays:

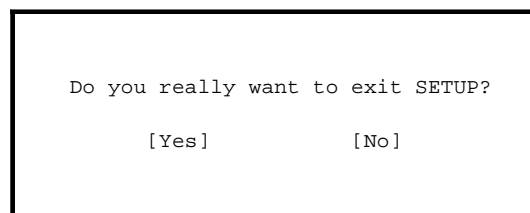

If you would like to keep the changes you made, use the cursor left/right keys to select **Yes**; then press **Enter**. Choose **No** if you want to discard the changes you made.

System Information

The System Information sub-menu displays basic and important information about your computer.

System Information	
CPU Type & Speed.....	Pentium @ III 500 MHz
Floppy Disk Drive.....	1.44 MB, 3.5-inch
Hard Disk Drive.....	xxxxx MB
HDD Serial Number.....	xxxxxxxxxxxxxxxxxxxxxxxxxxxx
System with.....	CD-ROM
System BIOS Version.....	V1.0 R01-A1
VGA BIOS Version.....	V1.0 R01-A1
Serial Number.....	xxxxxxxxxxxxxxxxxxxxxxxxxxxx
Asset Tag Number.....	xxxxxxxxxxxxxxxxxxxxxxxxxxxx
Product Name.....	xxxxxxxxxxxxxxxxxxxxxxxxxxxx
Manufacturer Name.....	xxxxxxxxxxxxxxxxxxxxxxxxxxxx
UUID.....	xxxxxxx-xxxx-xxxx-xxxx-xxxxxxxxxx

↑↓ = Move highlight bar, ←→ = Change Setting, F1 = Help

NOTE: The screen above is a sample and may not reflect the actual data on your computer. “X” may refer to a series of numbers and/or characters.

The following table describes the information in this sub-menu.

Parameter	Description
CPU Type & Speed	Shows the type and speed in Megahertz of the Central Processing Unit (CPU)
Floppy Disk Drive	Shows the floppy disk drive type.
Hard Disk Drive	Shows the size or capacity of the hard disk.
HDD Serial Number	Shows the serial number of the hard disk
System with	Shows the drive type installed in the AcerMedia Bay.
System BIOS Version	Shows the version number of the BIOS.
VGA BIOS Version	Shows the version number of the VGA display BIOS.
Serial Number	Shows the serial number of the computer.
Asset Tag Number	Shows the asset tag number of the computer.
Product Name	Shows the product name of the computer.
Manufacturer Name	Shows the manufacturer of the computer
UUID	Shows the universally unique identifier of your computer

The items in this sub-menu are important and vital information about your computer. If you experience computer problems and need to contact technical support, this data helps our service personnel know more about your computer.

Basic System Settings

The Basic System Settings sub-menu allows you to set the system date and time.

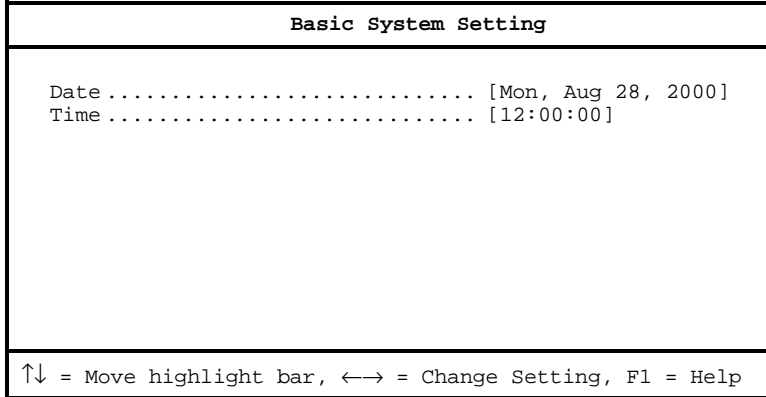

The following table describes the parameters in this sub-menu.

Parameter	Description	Format
Date	Sets the system date.	DDD MMM DD, YYYY (day-of-the-week month day, year)
Time	Sets the system time.	HH:MM:SS (hour:minute:second)

Startup Configuration

The Startup Configuration sub-menu contains parameter values that define how your computer behaves on system startup.

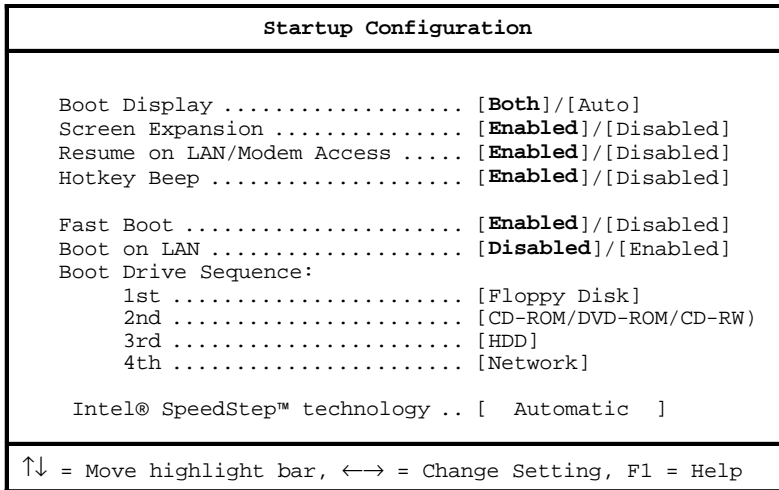

The following table describes the parameters in this sub-menu. Settings in **boldface** are the default and suggested parameter settings.

Parameter	Description	Options
Boot Display	Sets the display on boot-up. When set to Auto , the computer automatically determines the display device when the computer starts up. If an external display device (e.g., monitor) is connected, it becomes the boot display; otherwise, the computer LCD is the boot display. When set to Both , the computer outputs to both the computer LCD and an external display device if one is connected.	Both or Auto
Screen Expansion	Enables or disables the screen expansion feature. When enabled, DOS screens expand to fill the LCD.	Enabled or Disabled
Resume on LAN/Modem Access	When enabled, allows your computer to resume when LAN/Modem access is active	Enabled or Disabled
Hotkey Beep	Enables or disables a system beep when a hotkey or key combination is pressed.	Enabled or Disabled
Fast Boot	Fast Boot allows your computer to boot up and resume from Sleep mode (including Standby and Hibernation modes) faster. When enabled, the operating system and BIOS communicate information about Plug-and-Play resources and previous boot-ups.	Enabled or Disabled
Boot on LAN	When enabled, allows your computer to boot by other computer or server through the LAN. And the LANDesk (R) Service Agent in Boot Drive Sequence item will be enabled.	Disabled or Enabled
Boot Drive Sequence	Specifies the order in which the computer starts up from. See the section below.	1st: Floppy Disk, 2nd: CD-ROM/DVD-ROM/ CD-RW, 3rd: HDD 4th: LANDesk (R) Service Agent
Intel(R) SpeedStep(TM) technology	Intel SpeedStep technology allows your computer to automatically adjust the CPU speed depending on the power source. If set to Automatic, system will adjust the processor speed by OS. If the power source is supplied by AC adapter, processor will run at the maximum speed. If the power source is supplied by battery, processor will run at the minimum speed.	Automatic Maximum Performance Battery Optimized Reversed

Setting the Boot Drive Sequence

The Boot Drive Sequence section lists boot priorities (1st, 2nd, 3rd and 4th) for bootable drives in your computer.

For example, the default value (1st:Floppy Disk, 2nd:CD-ROM, 3rd:HDD and 4th:LANDesk (R) Service Agent) tells the computer to first search for a bootable floppy disk in the floppy drive. If it finds one present, it boots up from that floppy disk. If not, the computer continues to search for a bootable CD-ROM in the CD-ROM drive. If it cannot boot up from the CD-ROM, it continues by booting up from the Hard Disk.

To set the boot drive sequence, use the **cursor up/down keys** to select a priority level (1st, 2nd, 3rd or 4th); then use the **cursor left/right** keys to select the device for that priority level.

Onboard Devices Configuration

The parameters in this screen are for advanced users only. You do not need to change the values in this screen because these values are already optimized.

The Onboard Devices Configuration sub-menu assigns resources to basic computer communication hardware.

Onboard Device Configuration	
Serial Port	[Enabled]/[Disabled]
Base Address	[3F8h]/[2F8h]/[3E8h]/[2E8h]
IRQ	[4]/[11]
IrDA FIR	
Base Address	[2F8h]/[3F8h]/[3E8h]/[2E8h]
IRQ	[3]/[4]
DRQ	[3]/[1]/[0]
Parallel Port	[Enabled]/[Disabled]
Base Address	[378h]/[278h]/[3BCh]
IRQ	[7]/[5]
Operation Mode	[ECP]/[EPP]/[Bi-directional] /[Standard]
ECP DMA Channel	[1]/[3]*Note
Video Memory Size	[8 MB]/[4 MB]
↑↓ = Move highlight bar, ←→ = Change Setting, F1 = Help	

NOTE: 1. This option item should be [---] if user chooses Bi-directional and Standard Mode.
2. When the device is disabled, all the sub-items will be showed with [---].

The following table describes the parameters in this sub-menu. Settings in **boldface** are the default and suggested parameter settings.

Parameter	Description	Options
Serial Port	Enables or disables the serial port. When enabled, you can set the base I/O address and interrupt request (IRQ) of the serial port.	Enabled or Disabled 3F8h , 3E8h, 2F8h or 2E8h 4 or 11
IrDA FIR	Allow you to set the base I/O address, Interrupt request (IRQ) and Direct Memory Access (DMA) of IrDA FIR port.	2F8h , 3F8h, 3E8h, 2E8h 3 or 4 3 , 1 or 0
Parallel Port	Enables or disables the parallel port. When enabled, you can set the base I/O address, interrupt request (IRQ) and operation mode of the parallel port. If operation mode is set to ECP, the direct memory access (DMA) channel of the parallel port is set to 1.	Enabled or Disabled 378h , 278h, or 3BCh 7 or 5 ECP , EPP, Standard, or Bi-directional 1
Video Memory Size	Allow you to set the video memory size that share with system memory.	8 MB 4 MB

System Security

The System Security sub-menu allows you to safeguard your computer and data with passwords and other security measures.

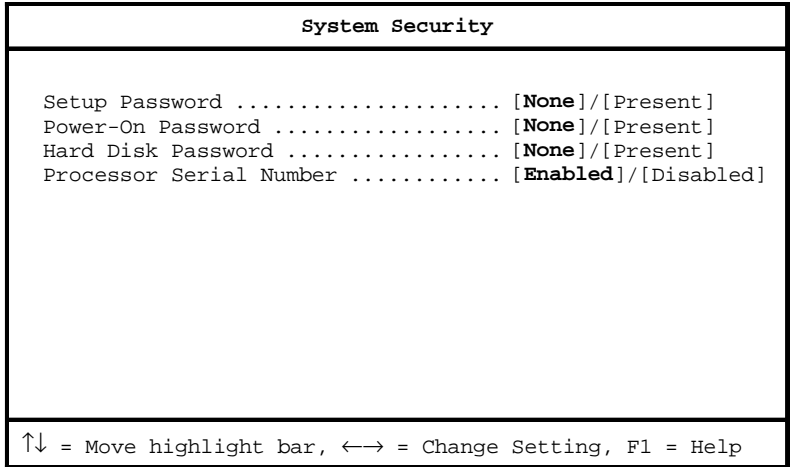

The following table describes the parameters in this screen. Settings in **boldface** are the default and suggested parameter settings.

Parameter	Description	Options
Setup Password	When set, this password protects the computer and this BIOS Utility from unauthorized entry. See the following section for instructions on how to set a password.	None or Present
Power-on Password	When set, this password protects the computer from unauthorized entry. See the following section for instructions on how to set a password.	None or Present
Hard Disk Password	When set, this password protects the hard disk from unauthorized access. See the following section for instructions on how to set a password.	None or Present
Processor Serial Number	The Pentium III processor includes a unique serial number which allows individual CPUs to be identified. You can turn off this feature by setting this parameter to Disabled.	Enabled or Disabled

Setting a Password

Follow these steps:

1. Use the cursor up/down keys to highlight a Password parameter (Setup, Power-on or Hard Disk) and press the **Enter** key. The password box appears:
2. Type a password. The password may consist of up to seven characters (A-Z, a-z, 0-9).



IMPORTANT: Be very careful when typing your password because the characters do not appear on the screen.

3. Press **Enter**. Retype the password to verify your first entry and press **Enter**.

After setting the password, the computer automatically sets the chosen password parameter to Present.

Three password types protect your computer from unauthorized access. Setting these passwords creates several different levels of protection for your computer and data:

- ❑ Setup Password prevents unauthorized entry to the BIOS Utility. Once set, you must key-in this password to gain access to the BIOS Utility.
- ❑ Power-On Password secures your computer against unauthorized use. Combine the use of this password with password checkpoints on boot-up and resume from hibernation for maximum security.
- ❑ Hard Disk Password protects your data by preventing unauthorized access to your hard disk. Even if the hard disk is removed from the computer and moved to another computer, it cannot be accessed without the Hard Disk Password.

When a password is set, a password prompt appears on the left-hand corner of the display screen.

1. When the Setup Password is set, the following prompt appears when you press **F2** to enter the BIOS Utility at boot-up.

Setup Password

Type the Setup Password and press **Enter** to access the BIOS Utility.

2. When the Power-on Password is set, the following prompt appears at boot-up.



Type the Power-on Password (a symbol appears for each character you type) and press **Enter** to use the computer. If you enter the password incorrectly, an **x** symbol appears. Try again and press **Enter**.

3. When the Hard Disk Password is set, the following prompt appears at boot-up.



Type the Hard Disk Password (a symbol appears for each character you type) and press **Enter** to use the computer. If you enter the password incorrectly, an **x** symbol appears. Try again and press **Enter**.

You have three chances to enter a password. If you successfully entered the password, the following symbol appears.



If you fail to enter the password correctly after three tries, the following message or symbol appears.

Setup
Incorrect password specified. System disabled.

Power-on/Hard Disk



Removing a Password

Should you decide to remove a password, do the following:

1. Use the cursor **up/down** (↑↓) keys to highlight a Password parameter (Setup, Power-on or Hard Disk).
2. Use the cursor **left/right** (→←) key to remove the password.

NOTE: When you want to remove the Hard Disk password, you are prompted for the Hard Disk password before it is removed.

Changing a Password

To change a password, follow these steps:

- ❑ Remove the current password. See “Removing a Password” on page 35.
- ❑ Set a new password. See “Setting a Password” on page 34.

Loading Default Settings

If you want to restore all parameter settings to their default values, select this menu item and press **Enter**. The following dialog box displays.

Do you want to load default settings?

[Yes] [No]

If you would like to load default settings for all parameters, use the cursor **left/right** (→←) keys to select **Yes**; then press **Enter**. Choose **No** if otherwise.

BIOS Flash Utility

The BIOS flash memory update is required for the following conditions:

- New versions of system programs
- New features or options

Use the AFlash utility to update the system BIOS flash ROM.

NOTE: Do not install memory-related drivers (XMS, EMS, DPMS) when you use AFlash.

NOTE: This program contains a readme.txt file. This readme.txt file will introduce how to use AFlash utility.

Executing Flash Program

IMPORTANT: If this diskette is not bootable, do the following actions before you use it:

1. Create a bootable disk.
2. Copy all AFlash files into this bootable diskette.
3. Put the bootable disk into TravelMate 350 series mobile, then re-boot.

IMPORTANT: Never turn off the system power while Flash BIOS is programming. This will damage your system.

4. After Flash BIOS is done, reboot the system.

NOTE: If there are any problems occurred during BIOS update, see "Index of PQA Diagnostic Error Code, Message" on page 81 for troubleshooting.

System Utility Diskette

This utility diskette is for the Acer TravelMate 350 notebook machine. It provides the following functions:

1. Panel ID Utility
2. Thermal & Fan Utility
3. Main Board Data Utility

To use this diskette, first boot from this diskette, then a "Microsoft Windows ME Startup Menu" prompt you to choose the testing item. Follow the instructions on screen to proceed.

NOTE: This program contains a readme.txt file. This readme.txt file will introduce each test utility and its functions.

IMPORTANT: If this diskette is not bootable, do the following actions before you use it:

1. Do system transfers. (Sys A:)
2. Copy HIMEM.SYS to A:\.
3. Copy RAMDRIVE.SYS to A:\.

Panel ID Utility

There is an EEPROM in the inverter which stores its supported LCD type ID code. If you replace an LCD with one of a different brand or use a new inverter, the ID information in the inverter EEPROM should be updated.

Follow the steps below to see the LCD Panel ID:

1. Follow the instruction on screen to read current or to set new LCD Panel ID code.

NOTE: When you set a new LCD Panel ID and the new LCD is not yet enabled (to function), so connect an external CRT to see the program execution process.

NOTE: Make sure the new ID code you choose corresponds with the LCD brand and type. If you write a wrong ID into inverter, just reboot and re-execute the program and input the correct ID code.

2. Restart computer - the new LCD should work normally.

NOTE: If LCD cannot display after change ID code, make sure you write the correct ID code, or try reconnecting the LCD FPC cable connectors.

Thermal and Fan Utility

The system is equipped with sensors to protect against system overheating. By setting System and processor thermal thresholds, the system can turn on the cooling fan or shut down automatically when temperatures reach the defined threshold parameters. This utility will test fan, processor thermal and system thermal.

Main Board Data Utility

This utility will display Main Board Data (MBD) which include header information, product name, manufacturer name, UUID (Universally Unique IDentifiers) and serial number. This function can display and create MBD data as well as store those information to LCD inverter EEPROM (not flash ROM).

System Diagnostic Diskette

IMPORTANT: ¹The diagnostics program here that we used is called PQA (Product Quality Assurance) and is provided by Acer Headquarters. You can utilize it as a basic diagnostic tool. To get this program, either download it from <http://csd.acer.com.tw> or find it in the TravelMate 350 service CD kit. To better fit local service requirements, your regional office MAY have other diagnostic program. Please contact your regional offices or the responsible personnel/channel to provide you with further technical details.

NOTE: This program contains a readme.txt file. This readme.txt file will introduce each test and its functions.

This diagnostic program divided into two diskettes is for the Acer TravelMate 350 notebook machine. It provides the following functions:

Disk 1:

1. PQA System Diagnostics
2. Audio Resource and Speaker Out Test
3. USB Register and Connect/Disconnect Test
4. IR Test

NOTE: The Infrared Ray setting in BIOS Setup must be set to enable when executing the Infrared Ray Test.

5. Exit

To use this diskette, first boot from this diskette, then a "Microsoft Windows ME Startup Menu" prompts you to choose the testing item. Follow the instructions on screen to proceed.

IMPORTANT: If this diskette is not bootable, do the following actions before you use it:

1. Do system transfers.
2. Copy the following files to A:\
HIMEM.SYS
MSCDEX.EXE
CHOICE.COM
RAMDRIVE.SYS

NOTE: When executing a parallel or serial port test in System Test item, a loopback tool is needed. This loopback is Acer proprietary design. You may reach the computerhwdoctor@acer.com.tw for ordering information.

Running PQA Diagnostics Program

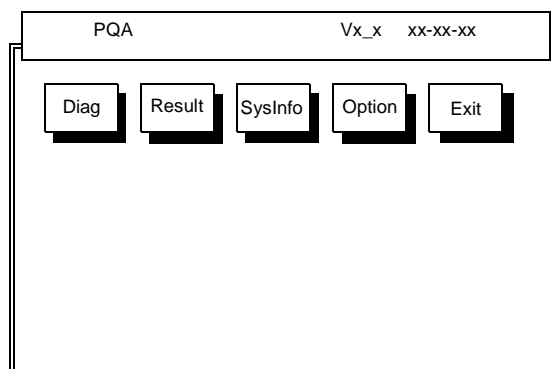

¹ New added description. Please pay attention to it.

Press →← to move around the main menu. Press Enter to enable the selected option. The main options are Diag, Result, SysInfo, Option and Exit.

The Diag option lets you select testing items and times.

The following screen appears when you select Diag from the main menu.

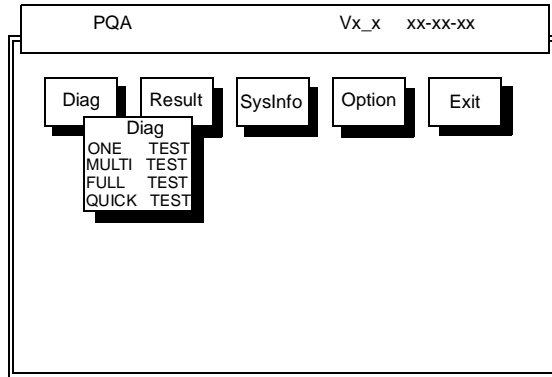

One Test performs a single test and Manual checks the selected test items in sequence.

Multi Test performs multiple tests of the selected items and check the selected test items in sequence.

Full Test performs all test items in detail for your system.

Quick Test performs all test items quickly for your system.

The screen below appears if you select Multi Test.

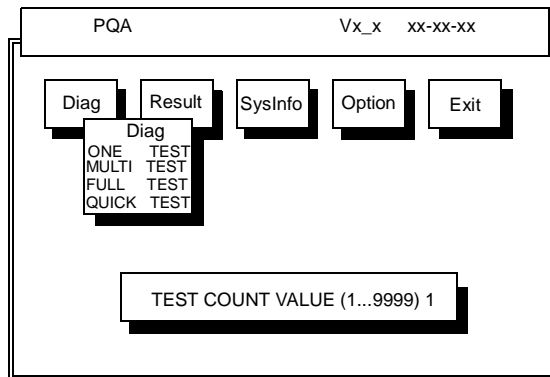

Specify the desired number of tests and press **Enter**.

After you specify the number of tests to perform, the screen shows a list of test items (see below).

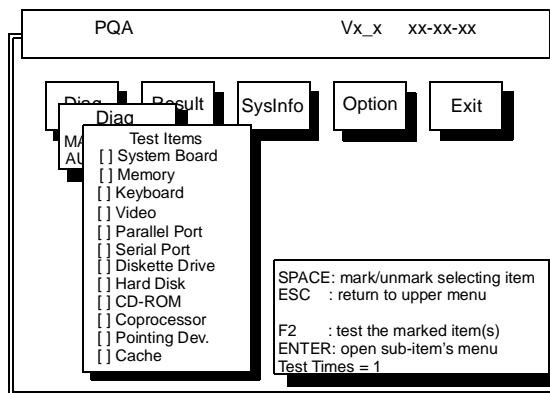

Move the highlight bar from one item to another. Press Space to enable or disable the item. Press **Enter** to view the available options of each selected item. Press **Esc** to close the submenu.

The right corner screen information gives you the available function keys and the specified test number.

- Space: Enables/disables the item
- ESC: Exits the program
- F1: Help
- F2: Tests the selected item(s)
- Enter: Opens the available options
- Test Times: Indicates the number of tests to perform.

NOTE: The F1 and F2 keys function only after you finish configuring the Test option.

NOTE: When any errors are detected by diagnostic program, refer to "Index of PQA Diagnostic Error Code, Message" on page 81 for troubleshooting.

Machine Disassembly and Replacement

This chapter contains step-by-step procedures on how to disassemble the notebook computer for maintenance and troubleshooting.

To disassemble the computer, you need the following tools:

- Wrist grounding strap and conductive mat to prevent electrostatic discharge
- Flat-bladed screwdriver
- Phillips screwdriver
- Hexagonal screwdriver
- Plastic stick

NOTE: The screws for the different components vary in size. During the disassembly process, group the screws with the corresponding components to avoid mismatches when putting back the components.

General Information

Before You Begin

Before proceeding with the disassembly procedure, make sure that you do the following:

1. Turn off the power to the system and all peripherals.
2. Unplug the AC adapter and all power and signal cables from the system.

Disassembly Procedure Flowchart

The flowchart on the succeeding page gives you a graphical representation on the entire disassembly sequence and instructs you on the components that need to be removed during servicing. For example, if you want to remove the system board, you must first remove the keyboard, then disassemble the inside assembly frame in that order.

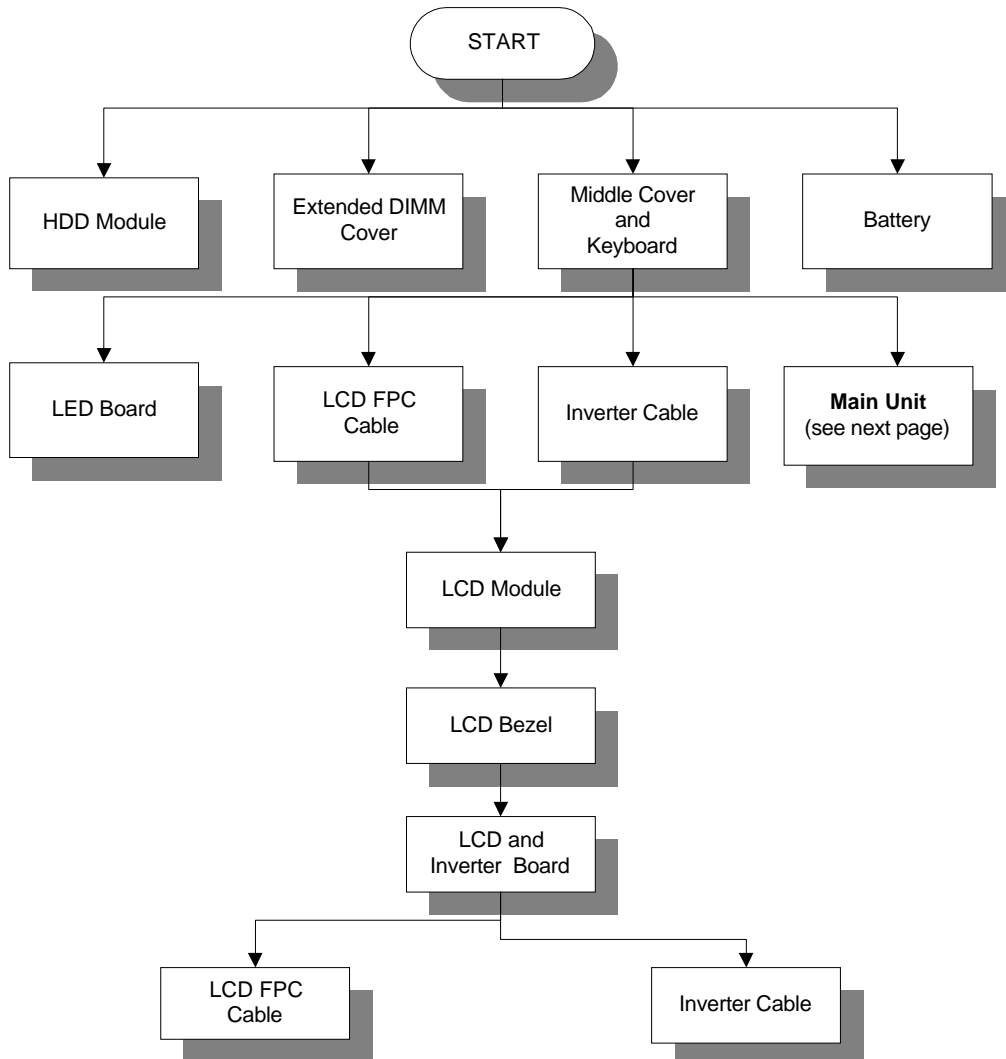

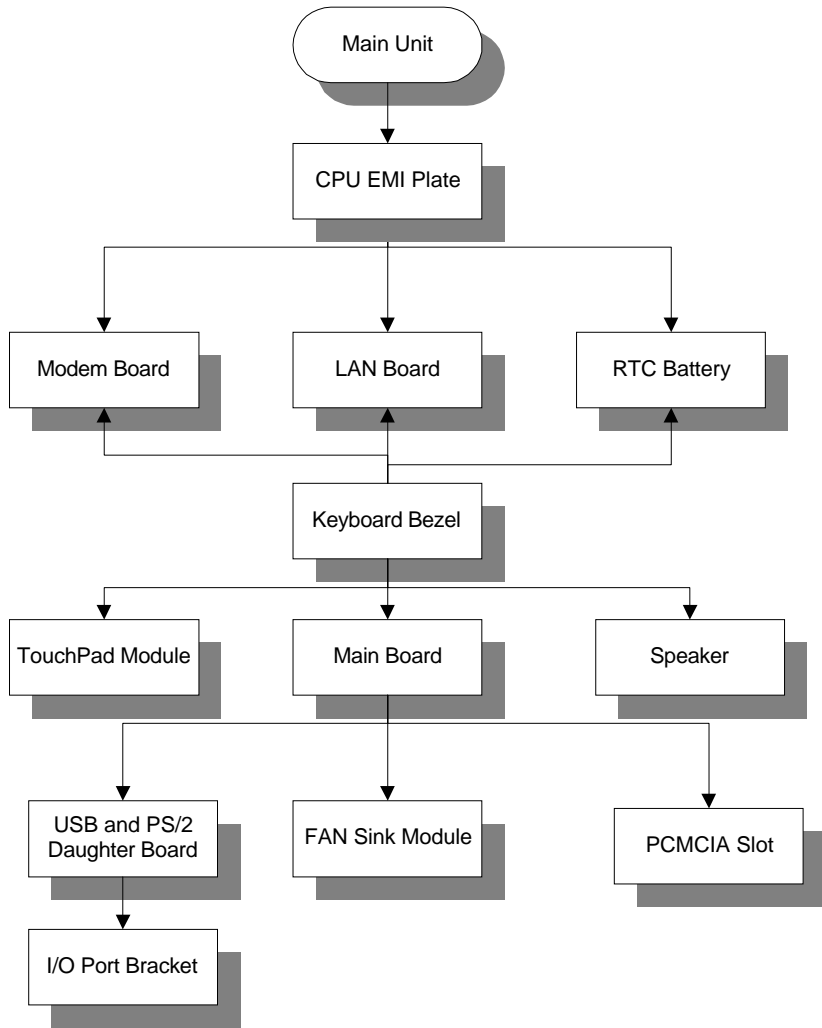

Removing the Battery Pack

1. To remove the battery pack, push the battery release button inward.
2. Slide the battery pack out of the machine.

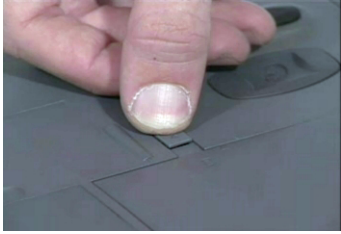

Removing the Hard disk drive Module

1. To remove the hard disk drive, first remove the screw from the hard disk drive bezel.
2. Then carefully remove the hard disk drive module from the machine.

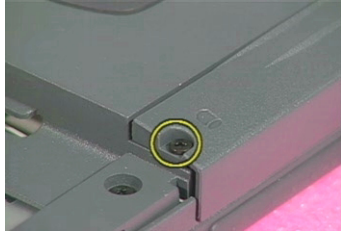

Disassembling the Hard disk drive Module

1. Remove the two screws from either side of the hard disk drive module.

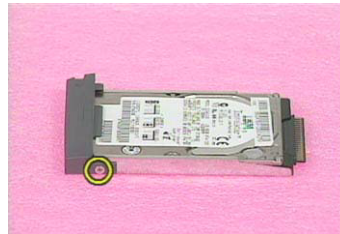
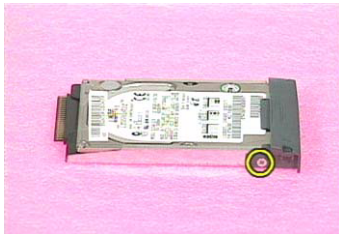

2. Remove the hard disk drive bezel from the hard disk drive module.
3. Slide the hard disk drive out from the hard disk drive bracket.

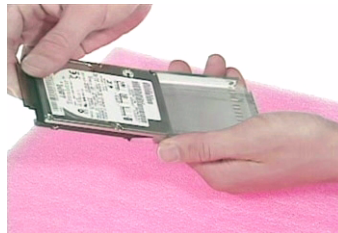
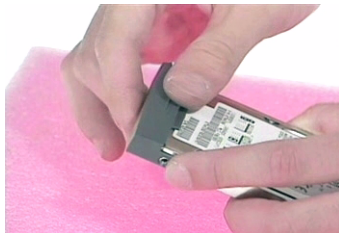

4. Then disconnect the drive connector from the drive module.



Removing the DVD-ROM and Floppy disk drive Module

1. To remove the DVD-ROM and floppy disk drive module, first disconnect the DVD-ROM and floppy disk drive cable from the easylink combo drive bay.



2. Then close the easylink combo drive bay cover.



Removing the Video Capture Kit

1. To remove the video capture kit, disconnect the video capture kit cable from the USB port on the rear of the unit.
2. Remove the video capture kit from the side of the LCD.



3. Then insert the rubber cover back into its position.



Removing the Extended Memory

1. To remove the extended memory from the machine, first loosen two screws from the memory cover.
2. Then lift the cover off and remove it from the main unit.

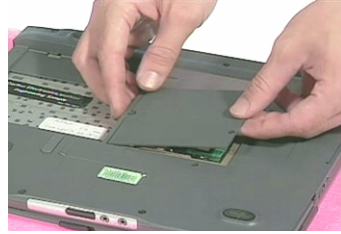
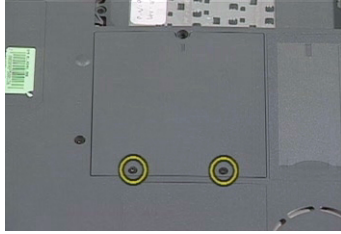

3. Push out the latches on both sides of the socket and pull the memory module from the socket.



Disassembling the LCD

Removing the Hinge Cap

1. To avoid risk on LCD damage, place a protective mylar film on the LCD surface before disassembly.



2. Push the hinge cap outward, then slide the cap out from the main unit.

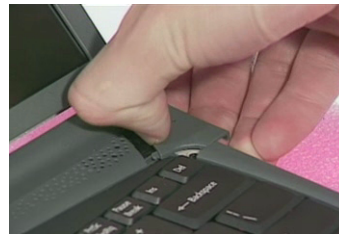
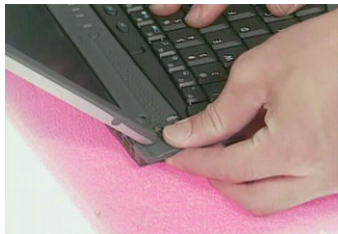

Removing the Middle Cover

1. Push the middle cover backward and lift the middle cover away from the system.

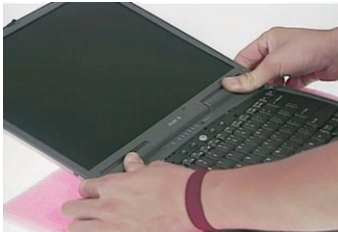

2. Disconnect the LED cable from the main board and remove the middle cover from the main unit.

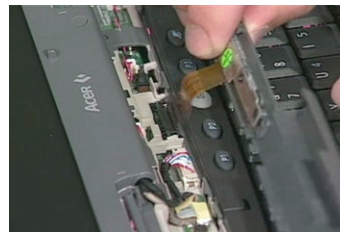

Removing the LED Board

1. Remove the three screws on the middle cover and then remove the LED board from the middle cover.

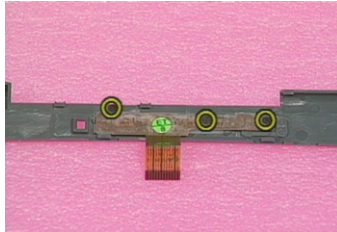

Removing the Keyboard

1. To remove the keyboard, first remove the screw from the main unit.



2. Pull the two latches downward to lift the keyboard upward and expose the keyboard.

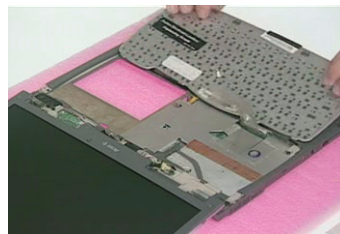
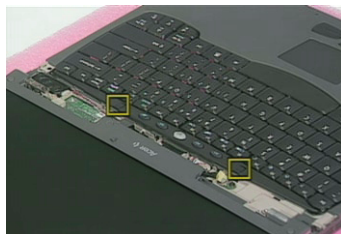

3. Disconnect the keyboard cable from the main board at CN20, then carefully remove the keyboard from the unit.

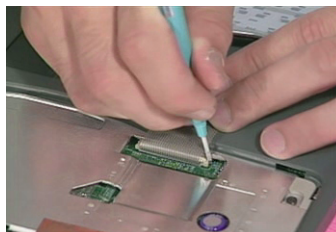
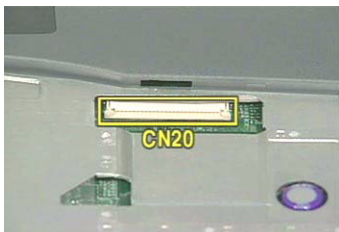

Removing the Inverter Board

1. Remove the two screws from the LCD coaxial cable.
2. Disconnect the coaxial cable from the main board at CN7.

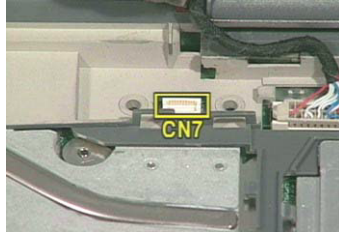
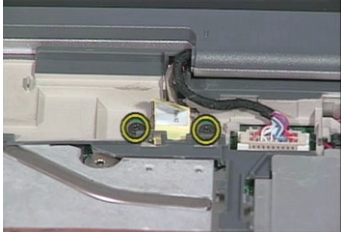

3. Disconnect the inverter cable from the main board at CN10.

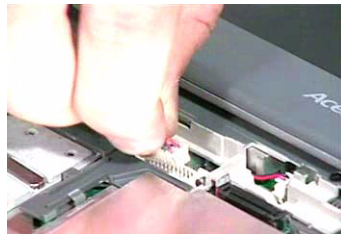

4. Remove the four screws from the hinges and bottom of the unit as shown.

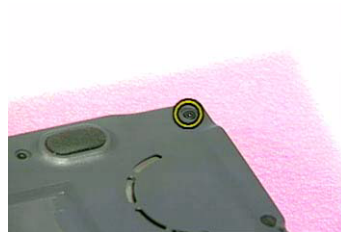
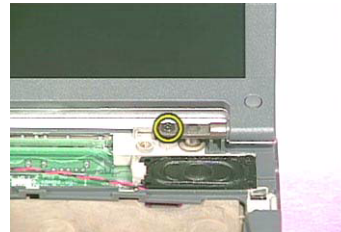
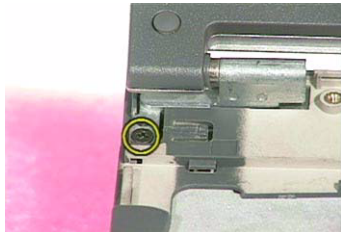

5. Then remove the LCD module from the main unit.

Disassembling the LCD Module

1. Remove the view capture kit rubber cover from each side of the LCD module.
2. Remove five LCD cushions and then five screws from the LCD bezel.

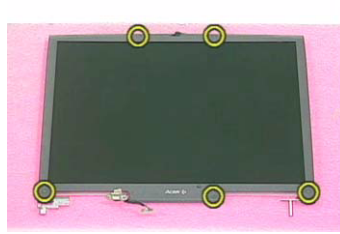

3. Snap off the LCD bezel carefully then remove the LCD bezel from the module.



4. Remove the screw from the inverter.
5. Disconnect the LCD power cable from the inverter and then remove the inverter from the LCD module.

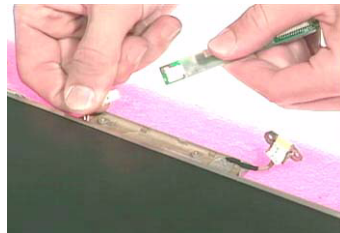
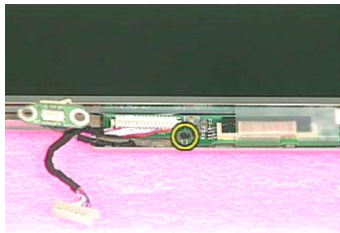

6. Disconnect the inverter cable from the inverter.



7. Remove four screws from both sides of the LCD.
8. Then remove the LCD from the LCD panel.

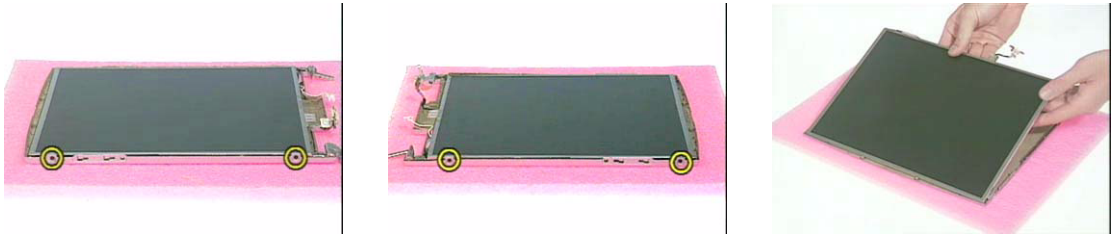

9. Remove the ESD tape and disconnect the LCD coaxial cable from the LCD gently.

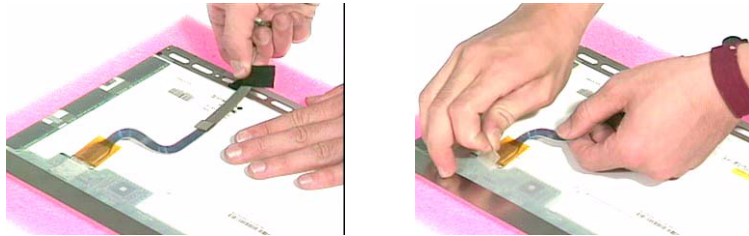

10. Then remove the two LCD hinges from the panel.



Removing the LAN Board

1. Remove the EMI mylar.
2. Loosen two screws from the CPU EMI plate.

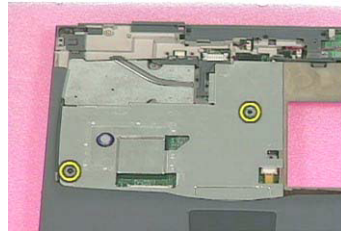
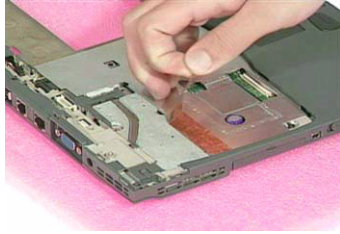

3. Remove the CPU EMI plate from the main unit.
4. Use a flat screw driver to remove the RTC battery.

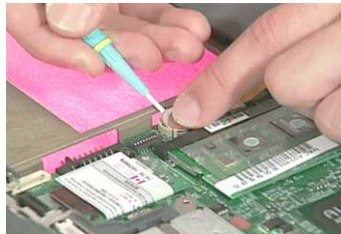

5. Push the latches on both sides of the socket and pull the LAN board out of the socket.

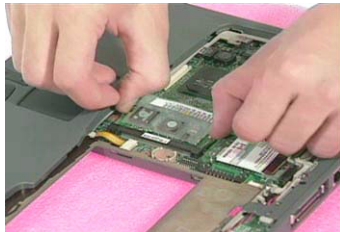

Removing the Upper Case

1. To remove the upper case, first remove the six screws from the bottom of the main unit and four screws from the upper case as shown.

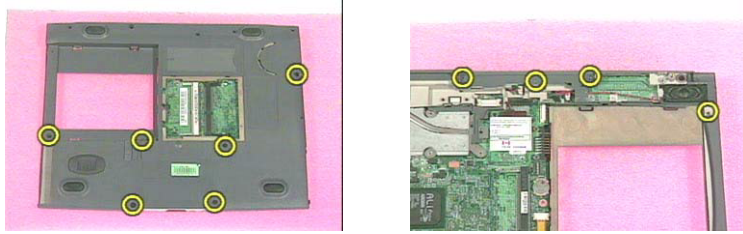

2. Disconnect the speaker cable from the main board at CN 8.



3. Disconnect the touchpad cable from the main board at CN18.

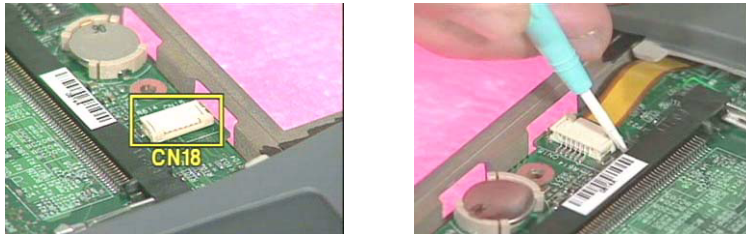

4. Then detach the upper case of the main unit carefully.

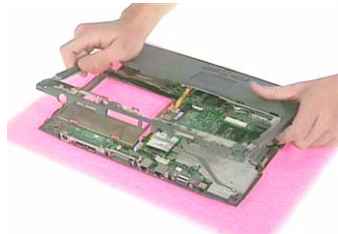

5. Disconnect the microphone cable from the main board at CN24.
6. Then remove the upper case from the main unit.

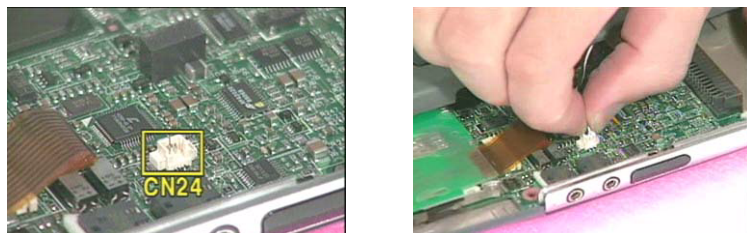

Removing the Speaker

1. Remove the two screws from the speaker and then remove the speaker from the upper case.

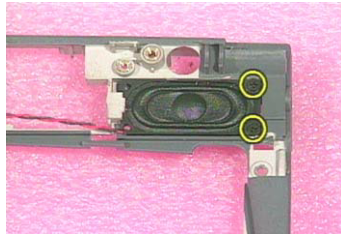

Removing the Touchpad

1. Remove the three screws from the touchpad support bracket then slide the bracket leftwards to detach it from the upper case.

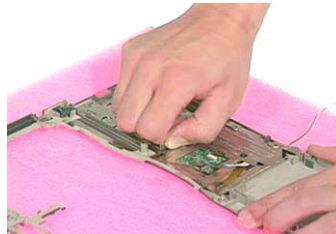
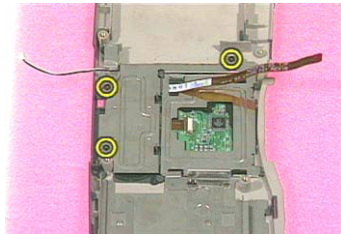

2. Disconnect the touchpad cable from the touchpad, then remove the touchpad board from the bracket.

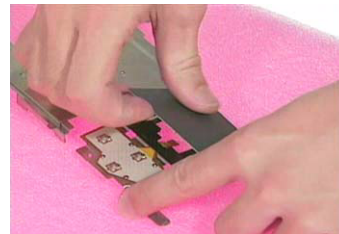
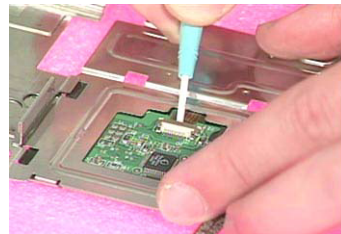

3. Remove the microphone from the upper case.



Removing the Modem Board

1. Disconnect the modem cable from the main board at CN5.

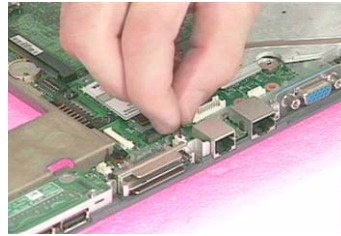
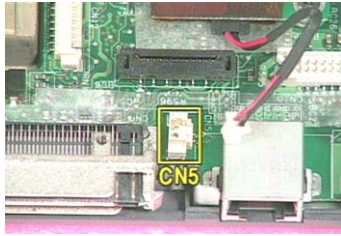

2. Remove the screw from the modem board and then remove the modem board from the main board at CN17.

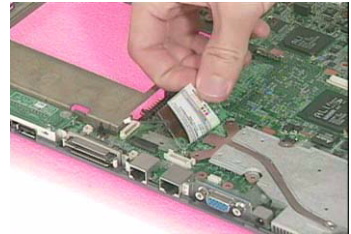
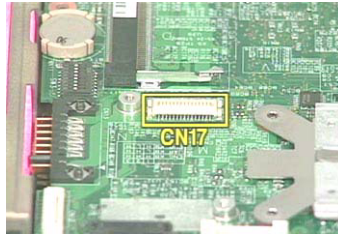
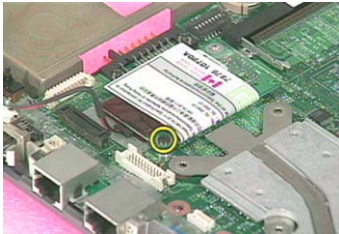

3. Remove the modem cable from the modem board.



Removing the Lower Case

Removing the Main board

1. Remove the three screws from the bottom of the unit and one screw from the main board.

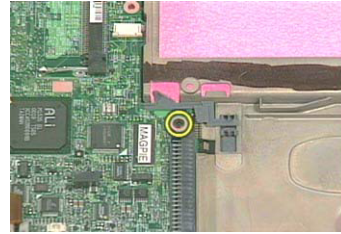
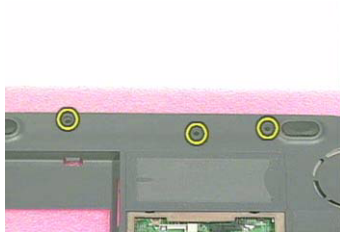

2. Remove the main board from the lower case.

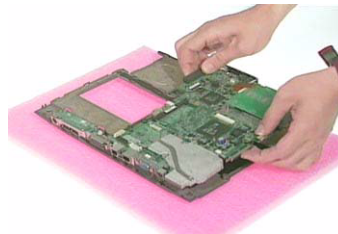

Removing the EMI Plate

1. Remove the four screws from the EMI plate.
2. Then remove the EMI plate from the main board.

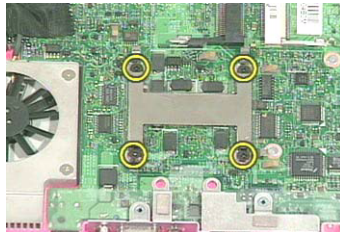

Removing the Heatsink

1. Detach the ESD tape from the main board.



2. Lift up the heatsink and disconnect the fan cable from the main board at CN15.
3. Then remove the heatsink.

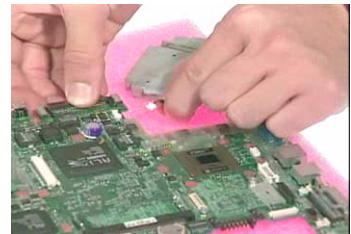

Removing the Daughter and I/O board

1. Remove the two screws from the USB daughter board.

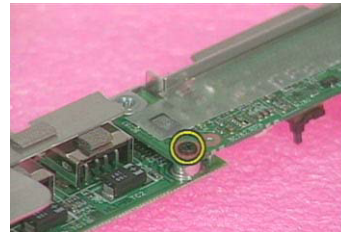
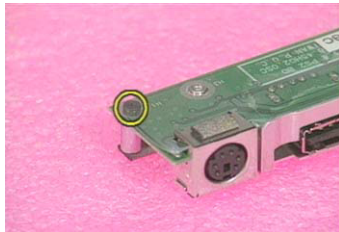

2. Then remove the USB daughter board from the main board at CN9.

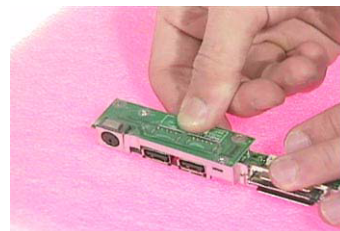

3. Remove the two hex screw from the I/O port bracket, then remove the I/O port bracket from the main board.
4. Detach the audio cover from the main board.

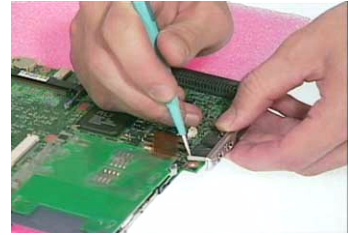
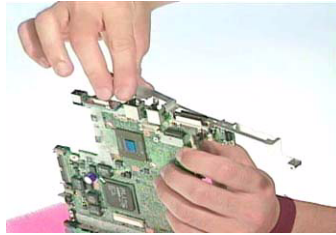
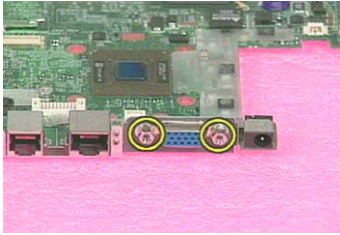

Removing the PCMCIA Slot

1. Disconnect the PCMCIA slot cable from the main board at CN23.

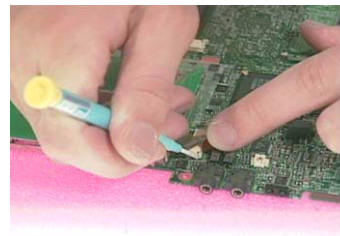
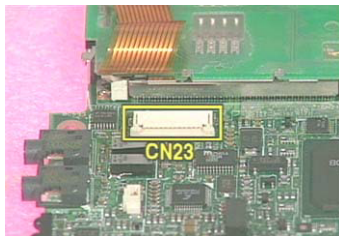

2. Loosen the three screws from the main board.
3. Detach the PCMCIA slot with a flat screw driver to loosen the latch.

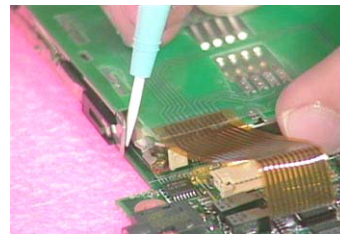
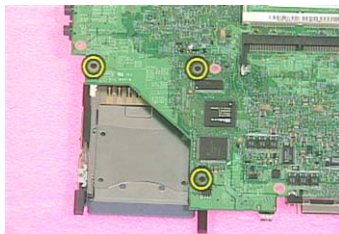

4. Then remove the PCMCIA slot from the main board.

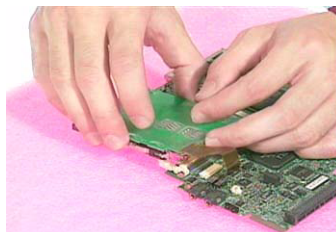

System Upgrade Procedure

Base Unit to Bluetooth Unit

1. To upgrade system from Base Unit to Bluetooth Unit, first install the bluetooth module to the upper case.

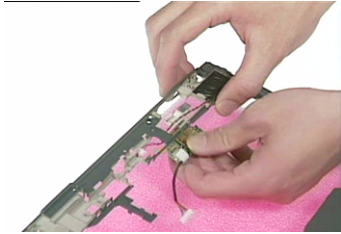

2. Then secure it with two screws and arrange the cable well.

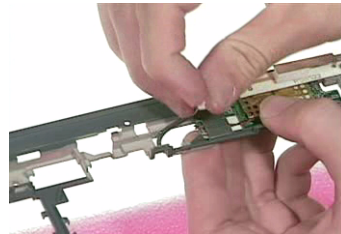
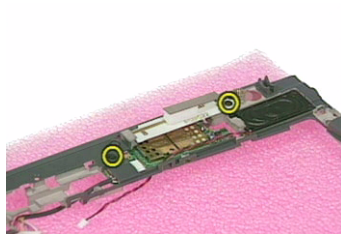

3. Re-attach the upper case back into the main unit and secure with one screw.

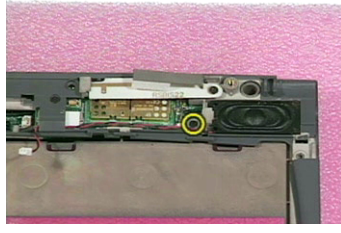

4. Re-connect the bluetooth and speaker cables back into the main board at CN12 and CN5 respectively.

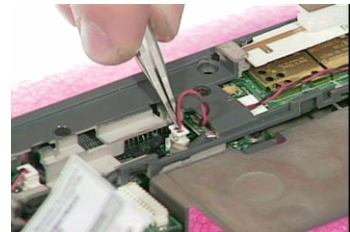
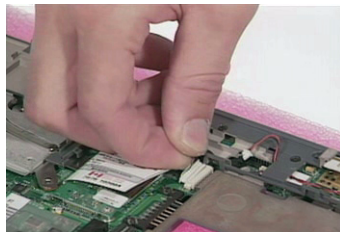
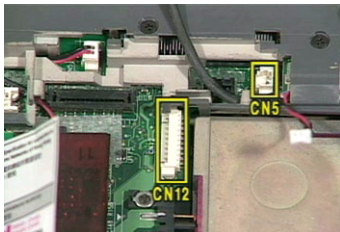

Base Unit to Wireless LAN Unit

1. To upgrade the system to from Base Unit to Wireless LAN Unit, first detach the upper case from the main unit carefully.



2. Note that the one marked with BT is for the right antenna and the one marked with 802.11b is for the left antenna.

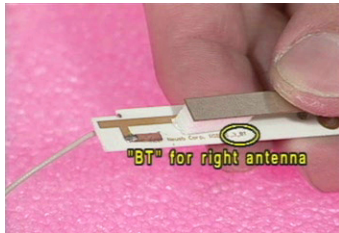

3. Attach the right antenna to the upper case and secure it with a screw.
4. Ensure that the RF cable is arranged well.

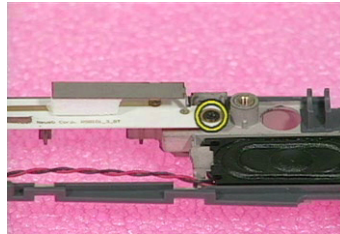
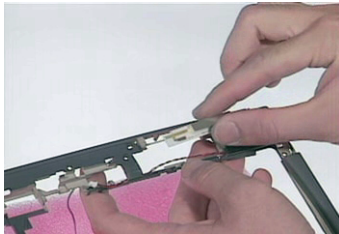

5. Attach the left antenna to the upper case and secure it with a screw.

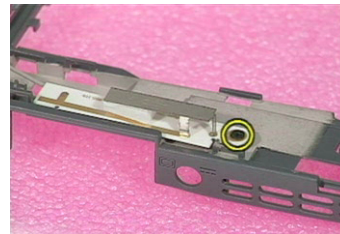
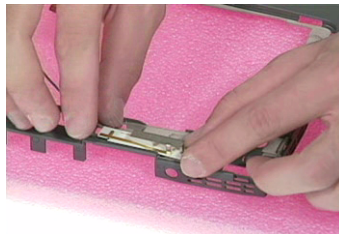

6. Remove the LAN board from the main board.
7. Then insert the wireless LAN board into its socket and press it down to secure well.

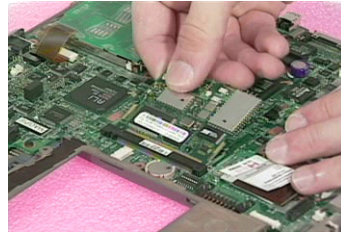
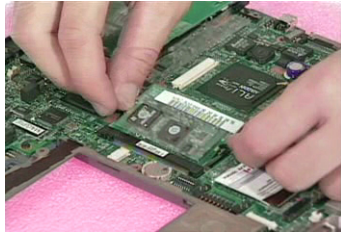

8. Be careful to arrange the right and left RF cables well.
9. Re-attach the upper case back into the main unit and connect the RF cables into the Wireless LAN board.

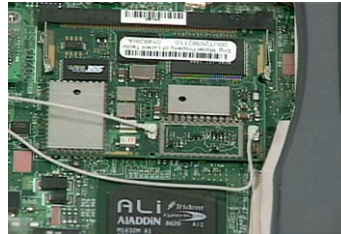
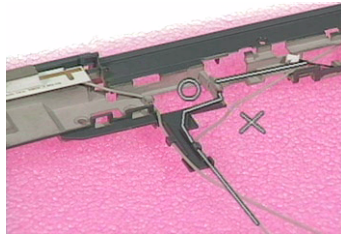

Wireless LAN to Wireless LAN and Bluetooth Combo Unit

1. Remove the right antenna from the upper case.
2. Attach the bluetooth module into the upper case.
3. Secure it with two screws.

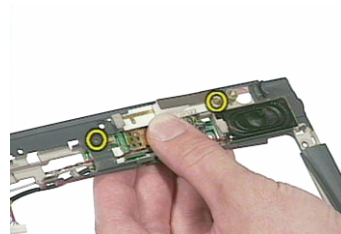
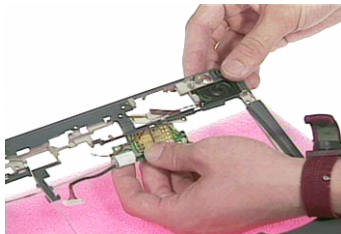

4. Arrange the bluetooth and the RF cables well.

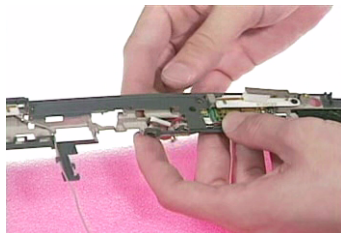

5. Re-attach the upper case back into the main unit and secure with one screw.

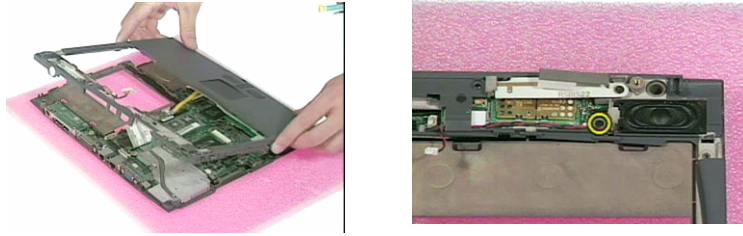

6. Re-connect the bluetooth and speaker cables back into the main board at CN12 and CN5 respectively.

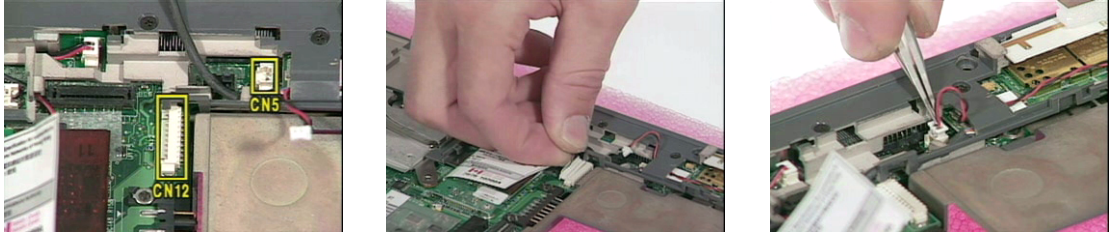

7. Re-connect the RF cables back into the Wireless LAN board.

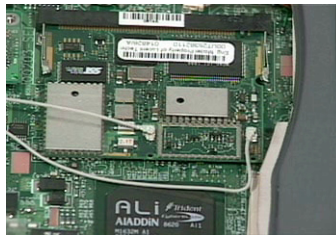

Troubleshooting

Use the following procedure as a guide for computer problems.

NOTE: The diagnostic tests are intended to test only Acer products. Non-Acer products, prototype cards, or modified options can give false errors and invalid system responses.

1. Obtain the failing symptoms in as much detail as possible.
2. Verify the symptoms by attempting to re-create the failure by running the diagnostic test or by repeating the same operation.
3. Use the following table with the verified symptom to determine which page to go to.

Symptoms (Verified)	Go To
Power failure. (The power indicator does not go on or stay on.)	"Power System Check" on page 71.
POST does not complete. No beep or error codes are indicated.	"Power-On Self-Test (POST) Error Message" on page 73 "Undetermined Problems" on page 80
POST detects an error and displayed messages on screen.	"Error Message List" on page 74
The diagnostic test detected an error and displayed a FRU code.	"Running PQA Diagnostics Program" on page 39
Other symptoms (i.e. LCD display problems or others).	"Power-On Self-Test (POST) Error Message" on page 73
Symptoms cannot be re-created (intermittent problems).	Use the customer-reported symptoms and go to "Power-On Self-Test (POST) Error Message" on page 73 "Intermittent Problems" on page 80 "Undetermined Problems" on page 80

System Check Procedures

External Diskette Drive Check

Do the following to isolate the problem to a controller, driver, or diskette. A write-enabled, diagnostic diskette is required.

NOTE: Make sure that the diskette does not have more than one label attached to it. Multiple labels can cause damage to the drive or cause the drive to fail.

Do the following to select the test device. See “Running PQA Diagnostics Program” on page 39 for details.

1. Boot from the diagnostics diskette and start the PQA program (see “Running PQA Diagnostics Program” on page 39).
2. Go to the diagnostic Diskette Drive in the test items.
3. Press F2 in the test items.
4. Follow the instructions in the message window.

If an error occurs with the internal diskette drive, reconnect the diskette connector on the main board.

If the error still remains:

1. Reconnect the external diskette drive/CD-ROM module.
2. Replace the external diskette drive/CD-ROM module.
3. Replace the main board.

External CD/DVD-ROM Drive Check

Do the following to isolate the problem to a controller, drive, or CD/DVD-ROM. Make sure that the CD/DVD-ROM does not have any label attached to it. The label can cause damage to the drive or can cause the drive to fail.

Do the following to select the test device:

1. Boot from the diagnostics diskette and start the PQA program (refer to “Running PQA Diagnostics Program” on page 39).
2. Go to the diagnostic CD/DVD-ROM in the test items.
3. Press F2 in the test items.
4. Follow the instructions in the message window.

If an error occurs, reconnect the connector on the main board. If the error still remains:

1. Reconnect the external diskette drive/CD/DVD-ROM module.
2. Replace the external diskette drive/CD/DVD-ROM module.
3. Replace the main board.

Keyboard or Auxiliary Input Device Check

Remove the external keyboard if the internal keyboard is to be tested.

If the internal keyboard does not work or an unexpected character appears, make sure that the flexible cable extending from the keyboard is correctly seated in the connector on the main board.

If the keyboard cable connection is correct, run the Keyboard Test. See “Running PQA Diagnostics Program” on page 39 for details.

If the tests detect a keyboard problem, do the following one at a time to correct the problem. Do not replace a non-defective FRU:

1. Reconnect the keyboard cables.
2. Replace the keyboard.
3. Replace the main board.

The following auxiliary input devices are supported by this computer:

- Numeric keypad
- External keyboard

If any of these devices do not work, reconnect the cable connector and repeat the failing operation.

Memory Check

Memory errors might stop system operations, show error messages on the screen, or hang the system.

1. Boot from the diagnostics diskette and start the PQA program (please refer to “Running PQA Diagnostics Program” on page 39).
2. Go to the diagnostic memory in the test items.
3. Press F2 in the test items.
4. Follow the instructions in the message window.

NOTE: Make sure that the DIMM is fully installed into the connector. A loose connection can cause an error.

Power System Check

To verify the symptom of the problem, power on the computer using each of the following power sources:

1. Remove the battery pack.
2. Connect the power adapter and check that power is supplied.
3. Disconnect the power adapter and install the charged battery pack; then check that power is supplied by the battery pack.

If you suspect a power problem, see the appropriate power supply check in the following list:

- “Check the Power Adapter” on page 71
- “Check the Battery Pack” on page 71

Check the Power Adapter

Unplug the power adapter cable from the computer and measure the output voltage at the plug of the power adapter cable. See the following figure

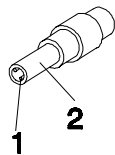

Pin 1: +19 to +20.5V
Pin 2: 0V, Ground

1. If the voltage is not correct, replace the power adapter.
2. If the voltage is within the range, do the following:
 - Replace the main board.
 - If the problem is not corrected, see “Undetermined Problems” on page 80.
 - If the voltage is not correct, go to the next step.

NOTE: An audible noise from the power adapter does not always indicate a defect.

3. If the power-on indicator does not light up, check the power cord of the power adapter for correct continuity and installation.
4. If the operational charge does not work, see “Check the Battery Pack” on page 71.

Check the Battery Pack

To check the battery pack, do the following:

1. Power off the computer.

2. Remove the battery pack and measure the voltage between battery terminals 1(ground) and 7(BT+). See the following figure

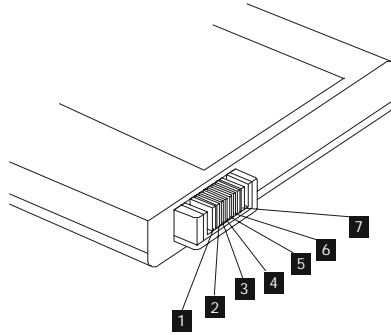

3. If the voltage is still less than 7.2 Vdc after recharging, replace the battery.

To check the battery charge operation, use a discharged battery pack or a battery pack that has less than 50% of the total power remaining when installed in the computer.

If the battery status indicator does not light up, remove the battery pack and let it return to room temperature. Re-install the battery pack.

If the charge indicator still does not light up, replace the battery pack. If the charge indicator still does not light up, replace the DC/DC charger board.

Touchpad Check

If the touchpad doesn't work, do the following actions one at a time to correct the problem. Do not replace a non-defective FRU:

1. Reconnect the touchpad cables.
2. Replace the touchpad.
3. Replace the main board.

After you use the touchpad, the pointer drifts on the screen for a short time. This self-acting pointer movement can occur when a slight, steady pressure is applied to the touchpad pointer. This symptom is not a hardware problem. No service actions are necessary if the pointer movement stops in a short period of time.

Power-On Self-Test (POST) Error Message

The POST error message index lists the error message and their possible causes. The most likely cause is listed first.

NOTE: Perform the FRU replacement or actions in the sequence shown in FRU/Action column, if the FRU replacement does not solve the problem, put the original part back in the computer. Do not replace a non-defective FRU.

This index can also help you determine the next possible FRU to be replaced when servicing a computer.

If the symptom is not listed, see “Undetermined Problems” on page 80.

The following lists the error messages that the BIOS displays on the screen and the error symptoms classified by function.

NOTE: Most of the error messages occur during POST. Some of them display information about a hardware device, e.g., the amount of memory installed. Others may indicate a problem with a device, such as the way it has been configured.

NOTE: If the system fails after you make changes in the BIOS Setup Utility menus, reset the computer, enter Setup and install Setup defaults or correct the error.

Index of Error Messages

Error Message List

Error Messages	FRU/Action in Sequence
Failure Fixed Disk	Reconnect hard disk drive connector. "Load Default Settings" in BIOS Setup Utility. Hard disk drive Main Board
Stuck Key	see "Keyboard or Auxiliary Input Device Check" on page 70 .
Keyboard error	see "Keyboard or Auxiliary Input Device Check" on page 70.
Keyboard Controller Failed	see "Keyboard or Auxiliary Input Device Check" on page 70.
Keyboard locked - Unlock key switch	Unlock external keyboard
Monitor type does not match CMOS - Run Setup	Run "Load Default Settings" in BIOS Setup Utility.
Shadow RAM Failed at offset: nnnn	BIOS ROM Main Board
System RAM Failed at offset: nnnn	DIMM Main Board
Extended RAM Failed at offset: nnnn	DIMM Main Board
System battery is dead - Replace and run Setup	Replace RTC battery and Run BIOS Setup Utility to reconfigure system time, then reboot system.
System CMOS checksum bad - Default configuration used	RTC battery Run BIOS Setup Utility to reconfigure system time, then reboot system.
System timer error	RTC battery Run BIOS Setup Utility to reconfigure system time, then reboot system. Main Board
Real time clock error	RTC battery Run BIOS Setup Utility to reconfigure system time, then reboot system. Main Board
Previous boot incomplete - Default configuration used	Run "Load Default Settings" in BIOS Setup Utility. RTC battery Main Board
Memory size found by POST differed from CMOS	Run "Load Default Settings" in BIOS Setup Utility. DIMM Main Board
Diskette drive A error	Check the drive is defined with the proper diskette type in BIOS Setup Utility See "External Diskette Drive Check" on page 70.
Incorrect Drive A type - run SETUP	Check the drive is defined with the proper diskette type in BIOS Setup Utility See "External Diskette Drive Check" on page 70.
System cache error - Cache disabled	Main Board
CPU ID:	Main Board
DMA Test Failed	DIMM Main Board
Software NMI Failed	DIMM Main Board
Fail-Safe Timer NMI Failed	DIMM Main Board

Error Message List

Error Messages	FRU/Action in Sequence
Device Address Conflict	Run "Load Default Settings" in BIOS Setup Utility. RTC battery Main Board
Allocation Error for device	Run "Load Default Settings" in BIOS Setup Utility. RTC battery Main Board
Failing Bits: nnnn	DIMM BIOS ROM Main Board
Fixed Disk n	None
Invalid System Configuration Data	BIOS ROM Main Board
I/O device IRQ conflict	Run "Load Default Settings" in BIOS Setup Utility. RTC battery Main Board
Operating system not found	Enter Setup and see if fixed disk and drive A: are properly identified. Diskette drive Hard disk drive Main Board

Error Message List

No beep Error Messages	FRU/Action in Sequence
No beep, power-on indicator turns off and LCD is blank.	Power source (battery pack and power adapter). See "Power System Check" on page 71. Ensure every connector is connected tightly and correctly. Reconnect the DIMM. LED board. Main Board.
No beep, power-on indicator turns on and LCD is blank.	Power source (battery pack and power adapter). See "Power System Check" on page 71. Reconnect the LCD connector Hard disk drive LCD inverter ID LCD cable LCD Inverter LCD Main Board
No beep, power-on indicator turns on and LCD is blank. But you can see POST on an external CRT.	Reconnect the LCD connectors. LCD inverter ID LCD cable LCD inverter LCD Main Board
No beep, power-on indicator turns on and a blinking cursor shown on LCD during POST.	Ensure every connector is connected tightly and correctly. Main Board
No beep during POST but system runs correctly.	Speaker Main Board

Index of Symptom-to-FRU Error Message

LCD-Related Symptoms

Symptom / Error	Action in Sequence
LCD backlight doesn't work LCD is too dark LCD brightness cannot be adjusted LCD contrast cannot be adjusted	Enter BIOS Utility to execute "Load Setup Default Settings", then reboot system. Reconnect the LCD connectors. Keyboard (if contrast and brightness function key doesn't work). LCD inverter ID LCD cable LCD inverter LCD Main Board
Unreadable LCD screen Missing pels in characters Abnormal screen Wrong color displayed	Reconnect the LCD connector LCD inverter ID LCD cable LCD inverter LCD Main Board
LCD has extra horizontal or vertical lines displayed.	LCD inverter ID LCD inverter LCD cable LCD Main Board

Indicator-Related Symptoms

Symptom / Error	Action in Sequence
Indicator incorrectly remains off or on, but system runs correctly	Reconnect the inverter board Inverter board Main Board

Power-Related Symptoms

Symptom / Error	Action in Sequence
Power shuts down during operation	Power source (battery pack and power adapter). See "Power System Check" on page 71. Battery pack Power adapter Hard drive & battery connection board Main Board
The system doesn't power-on.	Power source (battery pack and power adapter). See "Power System Check" on page 71. Battery pack Power adapter Hard drive & battery connection board Main Board
The system doesn't power-off.	Power source (battery pack and power adapter). See "Power System Check" on page 71. Hold and press the power switch for more than 4 seconds. Main Board
Battery can't be charged	See "Check the Battery Pack" on page 71. Battery pack Main Board

PCMCIA/Smart Card-Related Symptoms

Symptom / Error	Action in Sequence
System cannot detect the PC Card (PCMCIA)	PCMCIA/Smart Card slot assembly Main Board
System cannot detect the Smart Card	Smart Card PCMCIA/Smart Card slot assembly Main Board
PCMCIA/Smart Card slot pin is damaged.	PCMCIA/Smart Card slot assembly

Memory-Related Symptoms

Symptom / Error	Action in Sequence
Memory count (size) appears different from actual size.	Enter BIOS Setup Utility to execute "Load Default Settings, then reboot system. DIMM Main Board

Speaker-Related Symptoms

Symptom / Error	Action in Sequence
In Windows, multimedia programs, no sound comes from the computer.	Audio driver Speaker Main Board
Internal speakers make noise or emit no sound.	Speaker Main Board

Power Management-Related Symptoms

Symptom / Error	Action in Sequence
The system will not enter hibernation	Keyboard (if control is from the keyboard) Hard disk drive Main Board
The system doesn't enter hibernation mode and four short beeps every minute.	See "Hibernation Mode" on page 25. Press Fn+F4 and see if the computer enters hibernation mode. Touchpad Keyboard Hard disk connection board Hard disk drive Main Board
The system doesn't enter standby mode after closing the LCD	See "Standby Mode" on page 25. LCD cover switch Main Board
The system doesn't resume from hibernation mode.	See "Hibernation Mode" on page 25. Hard disk connection board Hard disk drive Main Board
The system doesn't resume from standby mode after opening the LCD.	See "Standby Mode" on page 25. LCD cover switch Main Board
Battery fuel gauge in Windows doesn't go higher than 90%.	Remove battery pack and let it cool for 2 hours. Refresh battery (continue use battery until power off, then charge battery). Battery pack Main Board

Power Management-Related Symptoms

Symptom / Error	Action in Sequence
System hangs intermittently.	See "Thermal and Fan Utility" on page 38. Reconnect hard disk/CD-ROM drives. Hard disk connection board Main Board

Peripheral-Related Symptoms

Symptom / Error	Action in Sequence
System configuration does not match the installed devices.	Enter BIOS Setup Utility to execute "Load Default Settings", then reboot system. Reconnect hard disk/CD-ROM/diskette drives.
External display does not work correctly.	Press Fn+F5, LCD/CRT/Both display switching See "Running PQA Diagnostics Program" on page 39. Main Board
USB does not work correctly	See "Running PQA Diagnostics Program" on page 39 Main Board
Print problems.	Ensure the "Parallel Port" in the "Onboard Devices Configuration" of BIOS Setup Utility is set to Enabled. Onboard Devices Configuration Run printer self-test. Printer driver Printer cable Printer Main Board
Serial or parallel port device problems.	Ensure the "Serial Port" in the Devices Configuration" of BIOS Setup Utility is set to Enabled. Device driver Device cable Device Main Board

Keyboard/Touchpad-Related Symptoms

Symptom / Error	Action in Sequence
Keyboard (one or more keys) does not work.	Reconnect the keyboard cable. Keyboard Main Board
Touchpad does not work.	Reconnect touchpad cable. Touchpad board Main Board

Modem-Related Symptoms

Symptom / Error	Action in Sequence
Internal modem does not work correctly.	modem board Main Board

NOTE: If you cannot find a symptom or an error in this list and the problem remains, see "Undetermined Problems" on page 80.

LAN-Related Symptoms

Symptom / Error	Action in Sequence
Internal LAN does not work correctly.	LAN board Main Board

Wireless LAN-Related Symptoms

Symptom / Error	Action in Sequence
Internal wireless LAN does not work correctly.	right or left antenna kits wireless LAN board Main Board

Intermittent Problems

Intermittent system hang problems can be caused by a variety of reasons that have nothing to do with a hardware defect, such as: cosmic radiation, electrostatic discharge, or software errors. FRU replacement should be considered only when a recurring problem exists.

When analyzing an intermittent problem, do the following:

1. Run the advanced diagnostic test for the main board in loop mode at least 10 times.
2. If no error is detected, do not replace any FRU.
3. If any error is detected, replace the FRU. Rerun the test to verify that there are no more errors.

Undetermined Problems

The diagnostic problems does not identify which adapter or device failed, which installed devices are incorrect, whether a short circuit is suspected, or whether the system is inoperative.

Follow these procedures to isolate the failing FRU (do not isolate non-defective FRU).

NOTE: Verify that all attached devices are supported by the computer.

NOTE: Verify that the power supply being used at the time of the failure is operating correctly. (See "Power System Check" on page 71):

1. Power-off the computer.
2. Visually check them for damage. If any problems are found, replace the FRU.
3. Remove or disconnect all of the following devices:
 - Non-Acer devices
 - Printer, mouse, and other external devices
 - Battery pack
 - Hard disk drive
 - DIMM
 - CD-ROM/Floppy diskette drive Module
 - PC Cards
4. Power-on the computer.
5. Determine if the problem has changed.
6. If the problem does not recur, reconnect the removed devices one at a time until you find the failing FRU.
7. If the problem remains, replace the following FRU one at a time. Do not replace a non-defective FRU:
 - Main Board
 - LCD assembly

Index of AFlash BIOS Error Message

Error Message	Action in Sequence
Hardware Error	See "System Diagnostic Diskette" on page 39
VPD Checksum Error	Reboot the system and then restart with this diskette.
BIOS Update Program Error	Turn off the power and restart the system.
System Error	Make sure this AFlash BIOS diskette for this model.
Without AC adapter	make sure to connect AC adapter
Battery Low	make sure to install a highly charged battery, and reboot system.

Index of PQA Diagnostic Error Code, Message

Error Code	Message	Action in Sequence
16XXX	Backup battery error	Backup battery
01XXX	CPU or main board error	Reload BIOS default setting. Main Board
02XXX	Memory error	DIMM Main Board
03XXX	Keyboard error	Reset Keyboard Keyboard Main Board
04XXX	Video error	Main Board
05XXX	Parallel Port error	Main Board
06XXX	Serial port or main board error	Main Board
07XXX	Diskette drive error	Diskette drive Main Board
08XXX	Hard disk error	Reload BIOS default setting Hard disk Main Board
09XXX	CD-ROM error	Reset CD-ROM cable CD-ROM drive Main Board
10XXX	Co-processor error	Main Board
11XXX	Pointing device error	Reset Keyboard Keyboard Main Board
12XXX	Cache test error	Main Board

Jumper and Connector Information

Top View

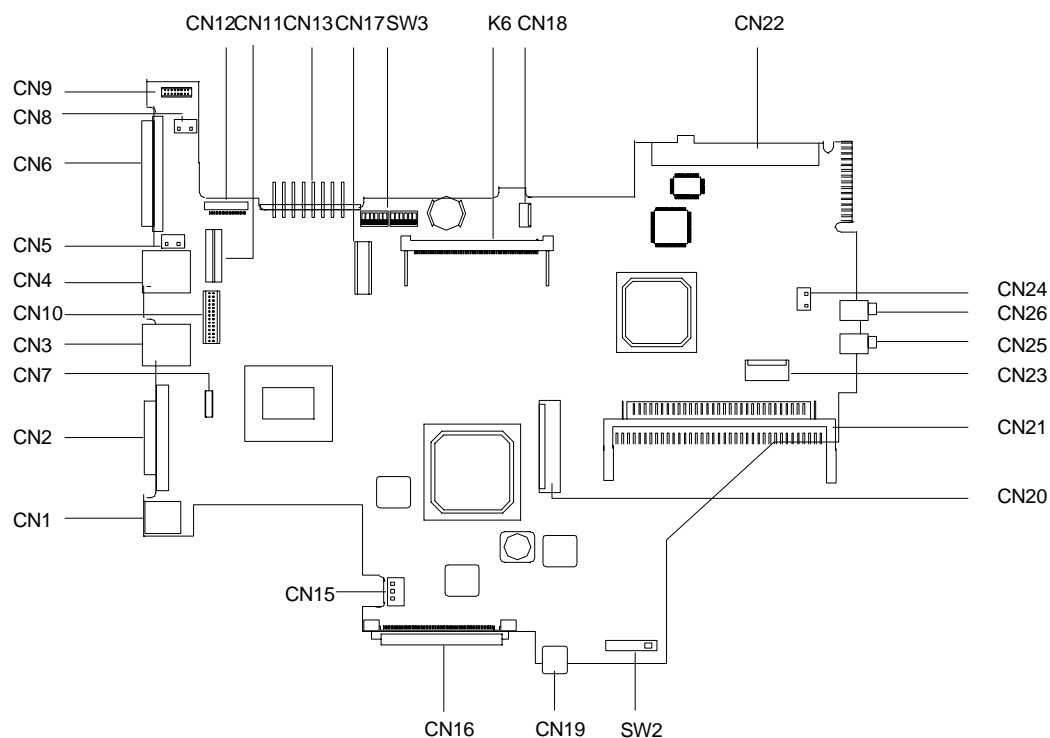

CN 1	DC-in port	CN 17	Modem board connector
CN 2	External monitor port	K6	Mini PCI socket
CN 3	LAN port	CN 18	Touch PAD connector
CN 4	Modem port	CN 22	Hard disk drive connector
CN 5	RJ45 connector	CN 24	Internal MIC connector
CN 6	Expansion port	CN 26	Line-in jack/external MIC jack
CN 7	LCD signal connector	CN 25	Speaker/Headphone-out jack
CN 8	2NT/speaker connector	CN 23	Smart Card connector
CN 9	USB daughter board connector	CN 21	PCMCIA socket connector
CN 10	Inverter connector	CN 20	Keyboard connector
CN 11	LED connector	CN 19	IEEE 1394 port
CN 12	Bluetooth connector	CN 16	EasyLink Combo Drive port
CN 13	Battery module connector	SW2	Power switch
CN 15	FAN connector		

SW3 Switch Settings

	SW3-1	SW3-2	SW3-3
English KBD	ON	ON	ON
Japan KBD	OFF	ON	ON
Europe KBD	ON	OFF	ON

SW3-6: Check password

SW3-6 = ON, Enable

SW3-6 = OFF, Disable

SW3-7: BIOS boot block erasable

SW3-7 = OFF, Disable

SW3-7 = ON, Enable

SW3-4, SW3-5, SW3-8: Reserve

Bottom View

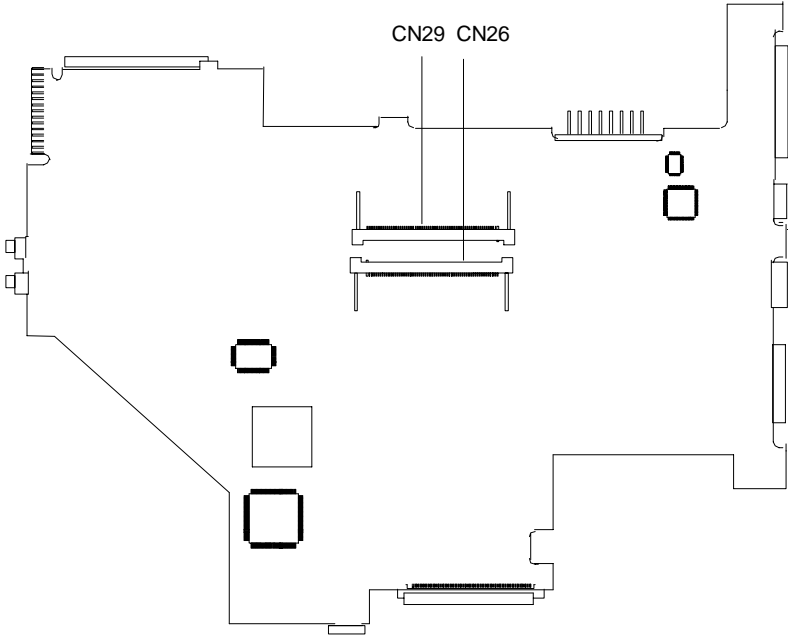

CN29 - DIMM 1 socket

CN26 - DIMM 2 socket







FRU (Field Replaceable Unit) List

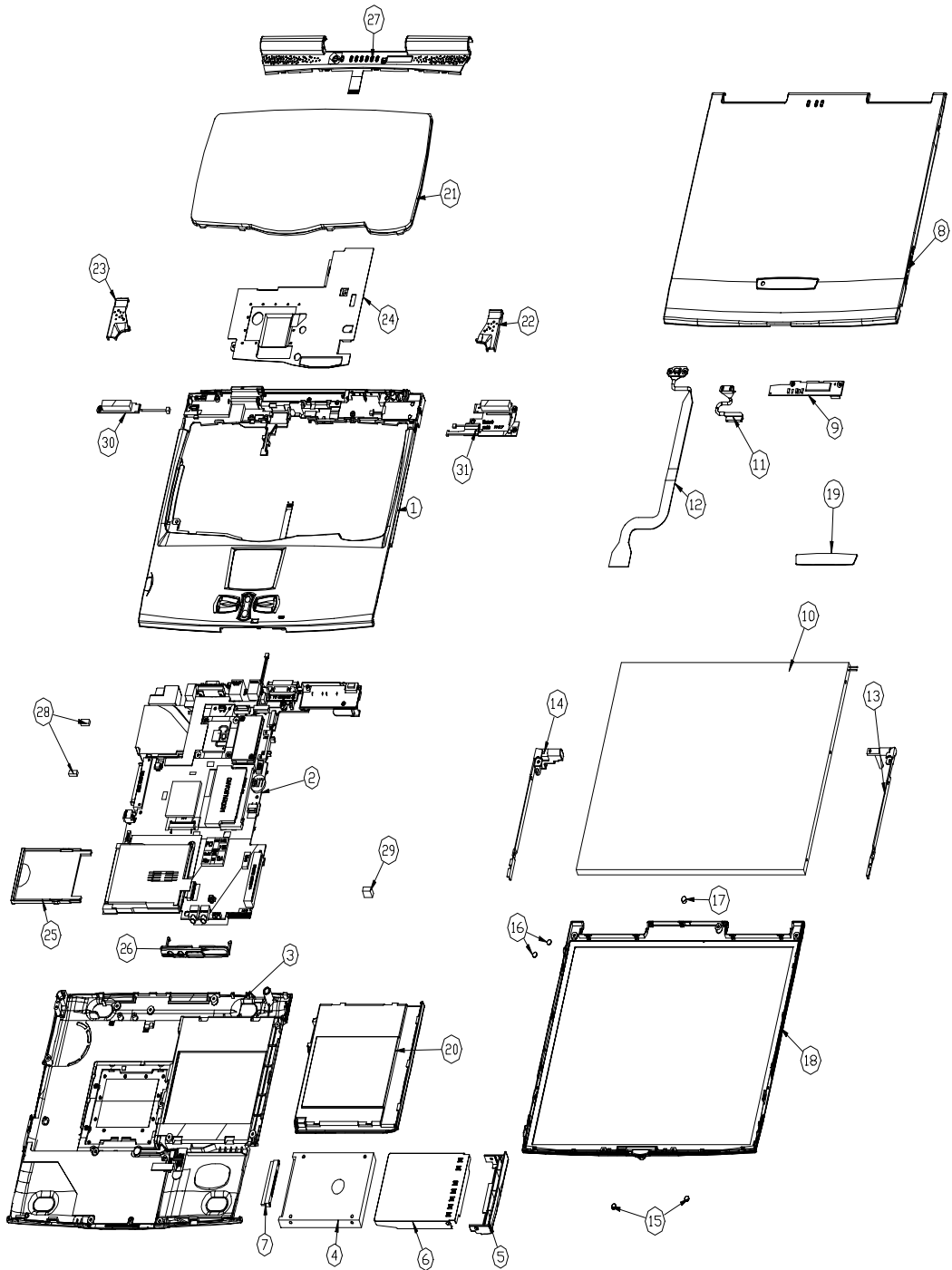





This chapter gives you the FRU (Field Replaceable Unit) listing in global configurations of TravelMate 350. Refer to this chapter whenever ordering for parts to repair or for RMA (Return Merchandise Authorization).





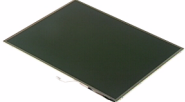

Please note that WHEN ORDERING FRU PARTS, you should check the most up-to-date information available on your regional web or channel. For whatever reasons a part number change is made, it will not be noted on the printed Service Guide. For ACER AUTHORIZED SERVICE PROVIDERS, your Acer office may have a DIFFERENT part number code from those given in the FRU list of this printed Service Guide. You MUST use the local FRU list provided by your regional Acer office to order FRU parts for repair and service of customer machines.

NOTE: To scrap or to return the defective parts, you should follow the local government ordinance or regulations on how to dispose it properly, or follow the rules set by your regional Acer office on how to return it.















Picture	No.	Partname	Description	Part No.
Memory				
	NS	Memory SODIMM 64M NEC	SODIMM 64M W17064I8NC8622A(NEC)	72.17064.C0N
		Memory SODIMM 64M Winbond	SODIMM 64M W9864CASA-75(WINBON	72.09864.B0E
		Memory SODIMM 64M PC100 PSC	SODIMM 64M P464S3D24U1-11 PC10	72.46424.00N
		Memory SODIMM 128M NEC	SODIMM 128M W17128IHNC86220(NE	72.17128.00N
		Memory SDIMM 128M Mitsubishi	SDIMM 128M MH16S64AVS-7TA	72.16S64.C0N
		Memory SODIMM 128M Winbond	SODIMM 128M W9812CASA-75(WINBO	72.09812.B0E
		Memory SODIMM 128M Siemens	SODIMM 128 HYS64V16220GDL-8-C2	72.64162.C0N
LCD				
	NS	LCD Module 13.3" LG	Assy LCD Module 13.3"LG TM350	6M.45H06.011
	NS	LCD 13.3" TFT LG.PHIL/ LP133X8-A2AC	LCD 13.3" LG.PHIL/ LP133X8-A2AC	56.0740F.021
	11	Inverter Cable	C.A Inverter Wire 15P(MAPI)	50.45H01.001
	NS	LCD Cable	C.A LCD Coaxial(LG- LP133X8)	50.45H05.001
	NS	LCD Panel	LCD Panel LG133X8 Assy	60.45H04.011





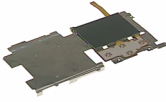

Picture	No.	Partname	Description	Part No.
	NS	LCD Hinge Pack	HING PACK FOR TM350	6K.45H01.001
	NS	LCD Bezel	LCD Bezel Assy for LG133X8	60.45H05.011
	NS	Inverter Board Sumdia	Inverter 13" IV5090/T REV.2A	19.21030.C21
	NS	LCD Module 13.3" TFT ADT	Assy LCD Module 13.3" ADT TM350	6M.45H05.001
	10	LCD 13.3" XGA TFT ADT/ L133X2-3	LCD 13.3"XGA ADT/ L133X2-3	56.0749C.061
	11	Inverter Cable	C.A Inverter Wire 15P(MAPI)	50.45H01.001
	12	LCD Cable	C.A ADT133 LCD Coax Cable(MAPI)	50.45H02.001







Picture	No.	Partname	Description	Part No.
	8	LCD Panel	LCD Panel Assy(MAPI)	60.45H04.001
	NS	Hinge Pack	HING PACK FOR TM350	6K.45H01.002
	18	LCD Bezel	LCD Bezel Assy(MAPI)	60.45H05.001
	9	Inverter Board Ambient/ T621174.00	Inverter T621174.00 MAGPIE	19.21030.B01
HDD/ Hard Disk Drive				
	NS	HDD Module 10G IBM	Assy HDD Module 10G IBM TM350	6M.45H03.031
	6	HDD Case	Assy HDD PLT TM330	60.40C15.001
	7	HDD Connector	CONN CTR ML 22P HH98227-A2(HDD)	20.80056.022





Picture	No.	Partname	Description	Part No.
	4	HDD 10G IBM/DJSA-210	HDD 9.5MM 10G IBM/ DJSA-210	56.02A75.041
	5	HDD Bezel	HDD Cover(MAPI)	42.45H04.001
	NS	HDD Module 5G IBM	Assy HDD Module 5G IBM TM350	6M.45H03.021
	NS	HDD 9.5MM 5G IBM/DJSA- 205	HDD 9.5MM 5G IBM/ DJSA-205	56.02017.021
	6	HDD Case	Assy HDD PLT TM330	60.40C15.001
	7	HDD Connector	CONN CTR ML 22P HH98227-A2(HDD)	20.80056.022
	5	HDD Bezel	HDD Cover(MAPI)	42.45H04.001

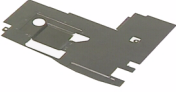



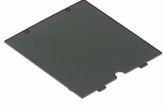
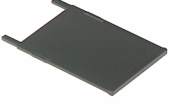

Picture	No.	Partname	Description	Part No.
Combo Module				
	NS	DVD-FDD Combo Module ADDO/DF2205	DVD Combo Bay FDD ADDO/DF2205	90.40C28.009
	NS	FDD 1.44M Mitsumi/D353F3-Z	FDD 1.44M MIT/D353F3-Z TM340	56.01049.001
	NS	DVD-ROM 6X MKE/SR-8174	DVD 6X MKE/SR-8174 ADDON TM340	56.22001.001
	NS	CDROM-FDD Combo Module TEAC	CD-ROM/FDD Combo TEAC/CF2405	90.40C28.019
Microphone				
	NS	Microphone w/Rubber	Assy Microphone w/ rubber TM350	6M.45H01.001
Heatsink				
	NS	CPU Heatsink w/Fan	Heatpipe Module Assy(MAPI)	60.45H16.001
Speaker				
	NS	Speaker 35X16X4.3	Speaker 35X16X4.3 ZK- 351601Q	23.40031.071

Picture	No.	Partname	Description	Part No.
Video Capture Kit				
	NS	USB Video Capture Kit (V6+)	USB Video Capture Kit (V6+)	91.16848.503
Keyboard				
	21	Keyboard 84key US Darfon	KB DEF US 84	99.N1282.001
Pointing Device				
	NS	TouchPad Module	ASSY T/P Module (MAPI)	60.45H06.011
Cables				
	NS	Modem Cable	C.A MDC MAGPIE	50.45H04.001
	NS	Power Cord 125V 3PIN	Cord 125V UL 3P K01081B1183WP	27.01618.051
	NS	I/O Port Cable 100/25+9PIN	C.A 100/25+9P 217MM IO B-NOTE	50.42F10.001
Main board				
	NS	Main board/MAGPIE PIII 650MHZ	MAGPIE TM350TE MNBOARD RPIII650	55.45H01.001
		Main board/MAGPIE PIII 700MHZ	MAGPIE TM351TEV PIII700 M/B	55.45H01.011

Picture	No.	Partname	Description	Part No.
	NS	PCMCIA/Smart Card Slot	CONN Cardbus&PCMCIA SKT 52539	21.H0027.001
	NS	EMI Plate	Base EMI Plate (MAPI)	40.45H05.001
Boards				
	NS	Modem 56K Ambit/ U98M005.01	Modem MDC Ambit/ U98M005.01	54.09011.301
	NS	USB/PS2 Board	MAGPIE TM350 USB & PS2 Board	55.45H02.011
	NS	LAN Board 10/100M Ambit/ 82559	LAN Card 10/100M Ambit/ 82559	54.03093.001
Adapter				
	NS	Adapter 60W 3PIN LITEON/ PA-1600-02AE	ADT 3P PA-1600-02AE W/ACER LOG	25.10068.091
		Adapter 60W 3PIN DELTA/ ADP-60DB	ADT 60W 90-264V ADP-60DB BB 3P	25.10064.111
Battery				
	NS	RTC Battery LI 3V	BTY LI 3V CR1220 36MAH	23.20004.091

Picture	No.	Partname	Description	Part No.
	20	Battery LI-ON Sanyo	Battery Module(MAPI)	60.45H03.001
Case/Cover/Bracket Assembly				
	NS	I/O Bracket	I/O Bracket ASSY	60.45H23.001
	26	Audio Cover	Audio Cover Assy(MAPI)	60.45H08.001
	NS	Hinge Cap Pack	HING Pack Cap for TM350	6K.45H02.001
	24	CPU EMI Plate	CPU EMI Plate(MAPI)	34.35H01.001
	27	Middle Cover	Middle Cover Assy(MAPI)	60.45H10.001
	NS	LED Board w/ Cable	LED Assy(MAPI)	60.45H07.001

Picture	No.	Partname	Description	Part No.
	1	Upper Case w/ speaker, touchpad, MIC	Upper Case Assy(MAPI)	60.45H12.001
	3	Lower Case	Lower Case Assy(MAPI)	60.45H11.001
	NS	Memory Cover	DIMM Cover Assy	60.45H13.001
Miscellaneous				
	19	Acer Logo	LBL ABS TM600/Acer	40.42F09.001
	25	PCMCIA Dummy Card	Card Dummy PCMCIA PA+ABS TM330	42.40C20.001
	NS	Power Button	Power Knob Assy(MAPI)	60.45H09.001
	NS	Foot Rubber	Rubber Foot	47.42F01.001
	15	LCD Cushion	LCD Cushion	47.40C01.001
	16	LCD Screw Mylar	LCD Screw Mylar (MAPI)	40.45H08.001
	17	LCD Screw Rubber	LCD Screw Rubber (H=3) MAPI	47.45H01.001

Picture	No.	Partname	Description	Part No.
	NS	Video Capture Kit Rubber	Rubber Camera TM340	47.40F07.002
	NS	Name Plate	Name Plate, TM350(For 350TE)	40.40F04.121
	NS	Smart Card	Smart Card, TM350, 85.6*54MM	42.45H17.001
Wireless Communication Device				
	NS	Wireless 802.11 Antenna Left	Antenna 802.11	25.90013.011
	NS	Wireless 802.11 Antenna Right	Antenna Intel_802_Antenna_R	25.90013.021
	NS	Wireless 802.11 module	Module 802.11 MAGPIE	25.H0002.001
Screws				
	NS	CPU EMI Plate, LCD, Inverter, Lower Case, Upper Case Screw	M2X4 (Screw Head High=0.3)MAPI	86.9A332.4R0
	NS	I/O Port Bracket Screw	SCRW HEX NUT W/ Washer #4 NI BT	34.00015.211
	NS	Modem Board, USB Board, Battery Connector, PCMCIA Slot, Mainboard, Spk, TouchPad Bracket Screw	Screw M2X4 (Head 0.3) NYLOK	86.00A23.320

Picture	No.	Partname	Description	Part No.
	NS	CPU EMI Plate, LCD Hinge, KB, Lower Case Screw	Screw M2.5X6	86.9A353.6R0
	NS	HDD Case Screw	Screw M3*4L W/F NI	86.5A524.4R0
	NS	LCD Hinge, LCD Cable Screw	SRW M2.5*8L B/ZN NYLOK 700	86.9A353.8R0
	NS	LCD Bezel Screw	Screw M2.5*4L NI	86.9A553.4R0
	NS	HDD Cover Screw	HDD Screw M2X7	86.00A10.120
	NS	Heatsink Screw	M2X4 (Big Head) MAPI	86.3A352.4R0
	NS	LED Board Screw	Screw Tapping 2X2.5	86.45H01.001

Model Definition and Configuration

TravelMate 350 Model Number Definitions

Model	LCD	CPU	Memory	Hard Disk Drive	CD/DVD-ROM	Floppy Disk Drive	Battery
350TE	13.3" TFT	P-III 650	64 MB	6 GB	24x ext.	External	Li-Ion
350TEV	13.3" TFT	P-III 650	64 MB	6 GB	6x DVD	External	Li-Ion
352TE	13.3" TFT	P-III 700	128 MB	12 GB	24x ext.	External	Li-Ion
352TEV	13.3" TFT	P-III 700	128MB	12 GB	6x DVD	External	Li-Ion

Test Compatible Components

This computer's compatibility is tested and verified by Acer's internal testing department. All of its system functions are tested under Windows 98, Windows 2000, Windows NT and Windows ME environment.

Refer to the following lists for components, adapter cards, and peripherals which have passed these tests. Regarding configuration, combination and test procedures, please refer to the TravelMate 350 Compatibility Test Report released by the Acer Mobile System Testing Department.

Microsoft Windows 98 Environment Test

Item	Specifications
Processor	Intel PIII 650MHz Intel PIII 700MHz Intel PIII 750MHz
Memory	64MB SDRAM 128MB SDRAM
LCD	13.3 TFT LCD LG 13.3 TFT LCD ADT
Floppy Disk Drive	Mitsumi 3.5" FDD (support 3 mode)
Hard Disk Drive	IBM 5GB IBM 10GB IBM 20GB
CD-ROM	24X CD ROM Drive
DVD-ROM	6X DVD ROM Drive
Battery	Sanyo Li-Ion Battery
Adapter	Lite- On
Network Adapters	
LAN Ethernet/10baseT/100baseT	3Com Etherlink III 3Com 10/100 16 bits Fast Etherlink D-link Ethernet Xircom Credit Card Ethernet Adapter Xircom CreditCard Ethernet Adapter IIps Xircom CreditCard Ethernet Adapter 10/100
LAN Token Ring	Madge Smart 16/4 RingNode MK2@ 3Com TokenLink III 16/4 IBM Turbo 16/4 TokenRing PC Card
Multi-Function Card	3Com Ethernet III LAN+33.6 Modem Global PC Card Combo 3Com 10/100 Fast EtherLink LAN+56K D-Link Winconnect 33.6 LAN/Fax modem combo Xircom CreditCard Ethernet 10/100 + Modem 56 Xircom Credit Card Ethernet + Modem 33.6
CardBus	3Com Fast EtherLink XL CardBus 3Com 10/100 LAN CardBus Intel EtherExpress PRO/100 Mobile Adapter TDK CardBus Ethernet 10/100 Base TX D-Link Fast Ethernet Cardbus 10/100Mbps IBM 10/100 EtherJet Cardbus Adapter (32-bit) Xircom Cardbus Ethernet 10/100 Intel Built-in LAN
Other	JetEye Wireless Infrared Connection (Internet function by IR) Xircom Pocket Internet III
Modem Adapter	
Modem (up to 28.8K)	TDK V34 28.8/14.4 Data Fax PCMCIA
Modem (up to 33.6)	Megahertz 33.6 PC Card Modem Hayes Optima 336 V34+Fax for PCMCIA W/EZjack IBM PCMCIA Data /Fax Modem International 33.6/14.4

Item	Specifications
Modem (up to 56K)	Pretec Modem 56K ActionTec DataLink 56Kbps Fax/Modem TDK V.90/K56Kflex Data/Fax Modem Xircom CREDITCARD MODEM 56 USR Megahertz 56K modem IBM 56K Double Jack Modem
ISDN	USR Megahertz ISDN 128K IBM ISDN Internet PC Card
I/O Peripheral	
I/O Display	IBM G72 IBM 9514-B04 TFT Monitor IBM P70 Acer AcerView 98i Compaq Color Monitor V70 NEC 20" Color Monitor NANA Flex Scan E35F
I/O - Keyboard	IBM 104key Keyboard Black Chicony Keyboard (USB) IBM Numeric Keypad III Compaq, Compaq Keyboard IBM, US English KBD (PS/AT Style) Microsoft Natural KBD USB IBM 104key Keyboard Black IBM 5576-B01 Windows Keyboard (JP) Acer 101 keyboard
I/O - Mouse	IBM PS Style Mouse (Black) Logitech USB Wheel Mouse Acer Aspire USB mouse (USB) Fu Hwa USB mouse IBM PS/2 Mini Mouse II Logitech PS Style Mouse Microsoft Inteli Mouse USB Microsoft Serial mouse
I/O - Projector	Mitsubishi LVP-X100A
I/O - Parallel (Printer)	IBM Network Printer 17 CANON Color Bubble Jet BJC600 EPSON Stylus Color 740 EPSON, EPSON Color Imaging CANON, CANON LASER SHOT B406GII HP DeskJet 880C printer (USB) HP DeskJet 890C HP LaserJet 6MP CANON USB Printer
I/O - Parallel (Scanner)	Logitech PageScan Color HP ScanJet 3300C Color Scanner (USB) HP DeskJet 970Cxi Acer AcerScan Prisa 620s

Item	Specifications
I/O - USB	Sanwa USB HUB (self-power) USB, USB HUB 4 PORTS TI-CHIPS USB, USB HUB 4 PORT - ATMEL EIZO I. Station USB HUB ELECOM USB HUB 4-port
I/O - USB Modem	Best Data USB 56K V.90 Modem Speakerphone BLASTER USB BLASTER Modem 56K V.90
I/O - USB (Speaker)	JS USB Digital Speaker AIWA MultiMedia Digital Speaker System (USB)
I/O - USB (Joystick)	USB Rockfire Avant Garde Flightstick Microsoft SIDEWINDER Precision PRO (USB)
I/O - USB Camera	Intel Create and Share Camera Pack Intel Digital Camera Kodak DVC 300 (Digital-Video-Camera) Kodak USB-Base Camera IBM, IBM PS Camera
I/O Adapter	
PCMCIA - SCSI	Adaptec 1480A slim SCSI CB Adaptec SlimSCSI APA-1460AB NewMedia BUS Toaster PCMCIA to SCSI
PCMCIA - CDROM	IBM Portable 20x Speed CD-ROM Drive w/ SOUND (JP) Panasonic 4x Portable CD-ROM Sound Player Panasonic 20x Portable CD-ROM Player
PCMCIA - ATA	Sundisk ATA 15MB VIPER 170E IBM Travel Kit 340MB microdrive I.O Data HardDisk PC Card
PCMCIA - Other	Sony - DCR TRV - 10/ACCKIT M90 (1394 Camera) with Video Capture PC card DVBK-CW200
PCMCIA	
USB Device	Nokia Cellular Data Suite 1.2 (support IR) w/ 6150 Nokia Card Phone Nokia Cellular Data Card (PCMCIA) w/ 8110 or 6150 Motorola, Digital Cellular Fax and Data Modem CELLect 3 GSM/ DCS1800 w/ cd928+ Ericsson, Mobile Office DC23 w/ PH388 Ericsson Mobile Office D127 w/ GF768

Microsoft Windows 2000 Environment Test

Item	Specifications
Processor	Intel PIII 650MHz Intel PIII 700MHz Intel PIII 750MHz
Memory	64MB SDRAM 128MB SDRAM
LCD	13.3 TFT LCD LG 13.3 TFT LCD ADT
Floppy Disk Drive	Mitsumi 3.5" FDD (support 3 mode)
Hard Disk Drive	IBM 5GB IBM 10GB IBM 20GB
CD-ROM	24X CD ROM Drive
DVD-ROM	6X DVD ROM Drive
Battery	Sanyo Li-Ion Battery
Adapter	Lite- On
Network Adapters	
LAN Ethernet/10baseT/100baseT	3Com Etherlink III 3Com 10/100 16 bits Fast Etherlink D-link Ethernet Xircom Credit Card Ethernet Adapter Xircom CreditCard Ethernet Adapter IIps Xircom CreditCard Ethernet Adapter 10/100
LAN Token Ring	Madge Smart 16/4 RingNode MK2@ 3Com TokenLink III 16/4 IBM Turbo 16/4 TokenRing PC Card
Multi-Function Card	3Com Ethernet III LAN+33.6 Modem Global PC Card Combo 3Com 10/100 Fast EtherLink LAN+56K D-Link Winconnect 33.6 LAN/Fax modem combo Xircom CreditCard Ethernet 10/100 + Modem 56 Xircom Credit Card Ethernet + Modem 33.6
CardBus	3Com Fast EtherLink XL CardBus 3Com 10/100 LAN CardBus Intel EtherExpress PRO/100 Mobile Adapter TDK CardBus Ethernet 10/100 Base TX D-Link Fast Ethernet Cardbus 10/100Mbps IBM 10/100 EtherJet Cardbus Adapter (32-bit) Xircom Cardbus Ethernet 10/100 Intel Built-in LAN
Other	Jeteye Wireless Infrared Connection (Internet function by IR) Xircom Pocket Internet III
Modem Adapter	
Modem (up to 28.8K)	TDK V34 28.8/14.4 Data Fax PCMCIA
Modem (up to 33.6)	Megahertz 33.6 PC Card Modem Hayes Optima 336 V34+Fax for PCMCIA W/EZjack IBM PCMCIA Data /Fax Modem International 33.6/14.4

Item	Specifications
Modem (up to 56K)	Pretec Modem 56K ActionTec DataLink 56Kbps Fax/Modem TDK V.90/K56Kflex Data/Fax Modem Xircom CREDITCARD MODEM 56 USR Megahertz 56K modem IBM 56K Double Jack Modem
ISDN	USR Megahertz ISDN 128K IBM ISDN Internet PC Card
I/O Peripheral	
I/O Display	IBM G72 IBM 9514-B04 TFT Monitor IBM P70 Acer AcerView 98i Compaq Color Monitor V70 NEC 20" Color Monitor NANA0 Flex Scan E35F
I/O - Keyboard	IBM 104key Keyboard Black Chicony Keyboard (USB) IBM Numeric Keypad III Compaq, Compaq Keyboard IBM, US English KBD (PS/AT Style) Microsoft Natural KBD USB IBM 104key Keyboard Black IBM 5576-B01 Windows Keyboard (JP) Acer 101 keyboard
I/O - Mouse	IBM PS Style Mouse (Black) Logitech USB Wheel Mouse Acer Aspire USB mouse (USB) Fu Hwa USB mouse IBM PS/2 Mini Mouse II Logitech PS Style Mouse Microsoft Inteli Mouse USB Microsoft Serial mouse
I/O - Projector	Mitsubishi LVP-X100A
I/O - Parallel (Printer)	IBM Network Printer 17 CANON Color Bubble Jet BJC600 EPSON Stylus Color 740 EPSON, EPSON Color Imaging CANON, CANON LASER SHOT B406GII HP DeskJet 880C printer (USB) HP DeskJet 890C HP LaserJet 6MP CANON USB Printer
I/O - Parallel (Scanner)	Logitech PageScan Color HP ScanJet 3300C Color Scanner (USB) HP DeskJet 970Cxi Acer AcerScan Prisa 620s
I/O - USB	Sanwa USB HUB (self-power) USB, USB HUB 4 PORTS TI-CHIPS USB, USB HUB 4 PORT - ATMEL EIZO I. Station USB HUB ELECOM USB HUB 4-port

Item	Specifications
I/O - USB Modem	Best Data USB 56K V.90 Modem Speakerphone BLASTER USB BLASTER Modem 56K V.90
I/O - USB (Speaker)	JS USB Digital Speaker AIWA MultiMedia Digital Speaker System (USB)
I/O - USB (Joystick)	USB Rockfire Avant Garde Flightstick Microsoft SIDEWINDER Precision PRO (USB)
I/O - USB Camera	Intel Create and Share Camera Pack Intel Digital Camera Kodak DVC 300 (Digital-Video-Camera) Kodak USB-Base Camera IBM, IBM PS Camera
I/O Adapter	
PCMCIA - SCSI	Adaptec 1480A slim SCSI CB Adaptec SlimSCSI APA-1460AB NewMedia BUS Toaster PCMCIA to SCSI
PCMCIA - CDROM	IBM Portable 20x Speed CD-ROM Drive w/ SOUND (JP) Panasonic 4x Portable CD-ROM Sound Player Panasonic 20x Portable CD-ROM Player
PCMCIA - ATA	Sundisk ATA 15MB VIPER 170E IBM Travel Kit 340MB microdrive I.O Data HardDisk PC Card
PCMCIA - Other	Sony - DCR TRV - 10/ACCKIT M90 (1394 Camera) with Video Capture PC card DVBK-CW200
PCMCIA	
USB Device	Nokia Cellular Data Suite 1.2 (support IR) w/ 6150 Nokia Card Phone Nokia Cellular Data Card (PCMCIA) w/ 8110 or 6150 Motorola, Digital Cellular Fax and Data Modem CELLect 3 GSM/ DCS1800 w/ cd928+ Ericsson, Mobile Office DC23 w/ PH388 Ericsson Mobile Office D127 w/ GF768

Windows Millenium Environment Test

Item	Specifications
Processor	Intel PIII 650MHz Intel PIII 700MHz Intel PIII 750MHz
Memory	64MB SDRAM 128MB SDRAM
LCD	13.3 TFT LCD LG 13.3 TFT LCD ADT
Floppy Disk Drive	Mitsumi 3.5" FDD (support 3 mode)
Hard Disk Drive	IBM 5GB IBM 10GB IBM 20GB
CD-ROM	24X CD ROM Drive
DVD-ROM	6X DVD ROM Drive
Battery	Sanyo Li-Ion Battery
Adapter	Lite- On
Network Adapters	
LAN Ethernet/10baseT/100baseT	3Com Etherlink III D-link Ethernet Xircom Credit Card Ethernet Adapter Xircom CreditCard Ethernet Adapter 10/100
LAN Token Ring	Madge Smart 16/4 RingNode MK2@ 3Com TokenLink III 16/4 IBM Turbo 16/4 TokenRing PC Card
Multi-Function Card	3Com Ethernet III LAN+33.6 Modem Global PC Card Combo 3Com 10/100 Fast EtherLink LAN+56K D-Link Winconnect 33.6 LAN/Fax modem combo Xircom CreditCard Ethernet 10/100 + Modem 56 Xircom Credit Card Ethernet + Modem 33.6
CardBus	3Com Fast EtherLink XL CardBus 3Com 10/100 LAN CardBus Intel EtherExpress PRO/100 Mobile Adapter TDK CardBus Ethernet 10/100 Base TX D-Link Fast Ethernet Cardbus 10/100Mbps IBM 10/100 EtherJet Cardbus Adapter (32-bit) Xircom Cardbus Ethernet 10/100 Intel Built-in LAN
Modem Adapter	
Modem (up to 28.8K)	TDK V34 28.8/14.4 Data Fax PCMCIA
Modem (up to 33.6)	Megahertz 33.6 PC Card Modem Hayes Optima 336 V34+Fax for PCMCIA W/EZjack IBM PCMCIA Data /Fax Modem International 33.6/14.4
Modem (up to 56K)	Pretec Modem 56K ActionTec DataLink 56Kbps Fax/Modem TDK V.90/K56Kflex Data/Fax Modem Xircom CREDITCARD MODEM 56 USR Megahertz 56K modem IBM 56K Double Jack Modem

Item	Specifications
ISDN	USR Megahertz ISDN 128K IBM ISDN Internet PC Card
I/O Peripheral	
I/O Display	IBM G72 IBM 9514-B04 TFT Monitor IBM P70 Acer AcerView 98i Compaq Color Monitor V70 NEC 20" Color Monitor NANA0 Flex Scan E35F
I/O - Keyboard	IBM 104key Keyboard Black Chicony Keyboard (USB) IBM Numeric Keypad III Compaq, Compaq Keyboard IBM, US English KBD (PS/AT Style) Microsoft Natural KBD USB IBM 104key Keyboard Black IBM 5576-B01 Windows Keyboard (JP) Acer 101 keyboard
I/O - Mouse	IBM PS Style Mouse (Black) Logitech USB Wheel Mouse Acer Aspire USB mouse (USB) Fu Hwa USB mouse IBM PS/2 Mini Mouse II Logitech PS Style Mouse Microsoft Inteli Mouse USB IBM ThinkPad Mobile Mouse IBM Numeric KeyPad III Microsoft Intelli Mouse Explorer Logitech MouseMan Wheel USB Comb for DOSV &iMAC Microsoft Serial mouse
I/O - Projector	Mitsubishi LVP-X100A
I/O - Parallel (Printer)	IBM Network Printer 17 CANON Color Bubble Jet BJC600 EPSON Stylus Color 740 EPSON, EPSON Color Imaging CANON, CANON LASER SHOT B406GII HP DeskJet 880C printer (USB) HP DeskJet 890C HP LaserJet 6MP CANON USB Printer
I/O - Parallel (Scanner)	Logitech PageScan Color HP ScanJet 3300C Color Scanner (USB) HP DeskJet 970Cxi Acer AcerScan Prisa 620s
I/O - USB	Sanwa USB HUB (self-power) USB, USB HUB 4 PORTS TI-CHIPS EIZO I. Station USB HUB Panasonic USB Speaker 3Com USB Network Interface Iomega USB ZIP250 ELECOM USB HUB 4-port

Item	Specifications
I/O - USB Modem	Best Data USB 56K V.90 Modem Speakerphone BLASTER USB BLASTER Modem 56K V.90
I/O - USB (Speaker)	JS USB Digital Speaker AIWA MultiMedia Digital Speaker System (USB)
I/O - USB (Joystick)	USB Rockfire Avant Garde Flightstick Microsoft SIDEWINDER Precision PRO (USB)
I/O - USB Camera	Intel Create and Share Camera Pack Kodak DVC 300 (Digital-Video-Camera) IBM, IBM PS Camera
I/O Adapter	
PCMCIA - SCSI	Adaptec 1480A slim SCSI CB Adaptec SlimSCSI APA-1460AB NewMedia BUS Toaster PCMCIA to SCSI
PCMCIA - CDROM	IBM Portable 20x Speed CD-ROM Drive w/ SOUND (JP) Panasonic 4x Portable CD-ROM Sound Player Panasonic 20x Portable CD-ROM Player
PCMCIA - ATA	Sundisk ATA 15MB VIPER 170E IBM Travel Kit 340MB microdrive I.O Data HardDisk PC Card IBM 340MB MicroDrive + PC Card Adapter SONY Memory Stick (64MB) + PC Card Adapter EPSON Flash Packer 6MB
PCMCIA - Other	IBM Portable Drive Bay IEEE1394 interface PCMCIA Card Lacie, LACIE IEEE1394 (Fire Wire) Hard Drive Sony - DCR TRV - 10/ACCKIT M90 (1394 Camera) with Video Capture PC card DVBK-CW200

Microsoft Windows NT Environment Test

Item	Specifications
Processor	Intel PIII 650MHz Intel PIII 700MHz Intel PIII 750MHz
Memory	64MB SDRAM 128MB SDRAM
LCD	13.3 TFT LCD LG 13.3 TFT LCD ADT
Floppy Disk Drive	Mitsumi 3.5" FDD (support 3 mode)
Hard Disk Drive	IBM 5GB IBM 10GB IBM 20GB
CD-ROM	24X CD ROM Drive
DVD-ROM	6X DVD ROM Drive
Battery	Sanyo Li-Ion Battery
Adapter	Lite- On
Network Adapters	
LAN Ethernet/10baseT/100baseT	3Com Etherlink III 3Com 10/100 16 bits Fast Etherlink D-link Ethernet Xircom Credit Card Ethernet Adapter Xircom CreditCard Ethernet Adapter IIps Xircom CreditCard Ethernet Adapter 10/100
LAN Token Ring	Madge Smart 16/4 RingNode MK2@ 3Com TokenLink III 16/4 IBM Turbo 16/4 TokenRing PC Card
Multi-Function Card	3Com Ethernet III LAN+33.6 Modem Global PC Card Combo 3Com 10/100 Fast EtherLink LAN+56K D-Link Winconnect 33.6 LAN/Fax modem combo Xircom CreditCard Ethernet 10/100 + Modem 56 Xircom Credit Card Ethernet + Modem 33.6
CardBus	3Com Fast EtherLink XL CardBus 3Com 10/100 LAN CardBus Intel EtherExpress PRO/100 Mobile Adapter TDK CardBus Ethernet 10/100 Base TX D-Link Fast Ethernet Cardbus 10/100Mbps IBM 10/100 EtherJet Cardbus Adapter (32-bit) Xircom Cardbus Ethernet 10/100 Intel Built-in LAN
Other	Jeteye Wireless Infrared Connection (Internet function by IR) Xircom Pocket Internet III
Modem Adapter	
Modem (up to 28.8K)	TDK V34 28.8/14.4 Data Fax PCMCIA
Modem (up to 33.6)	Megahertz 33.6 PC Card Modem Hayes Optima 336 V34+Fax for PCMCIA W/EZjack IBM PCMCIA Data /Fax Modem International 33.6/14.4

Item	Specifications
Modem (up to 56K)	Pretec Modem 56K ActionTec DataLink 56Kbps Fax/Modem TDK V.90/K56Kflex Data/Fax Modem Xircom CREDITCARD MODEM 56 USR Megahertz 56K modem IBM 56K Double Jack Modem
ISDN	USR Megahertz ISDN 128K
I/O Peripheral	
I/O Display	IBM G72 IBM 9514-B04 TFT Monitor IBM P70 Acer AcerView 98i Compaq Color Monitor V70 NEC 20" Color Monitor NANA0 Flex Scan E35F
I/O - Keyboard	IBM 104key Keyboard Black Chicony Keyboard (USB) IBM Numeric Keypad III Compaq, Compaq Keyboard IBM, US English KBD (PS/AT Style) Microsoft Natural KBD USB IBM 104key Keyboard Black IBM 5576-B01 Windows Keyboard (JP) Acer 101 keyboard
I/O - Mouse	IBM PS Style Mouse (Black) Logitech USB Wheel Mouse Acer Aspire USB mouse (USB) Fu Hwa USB mouse IBM PS/2 Mini Mouse II Logitech PS Style Mouse Microsoft Inteli Mouse USB Microsoft Serial mouse
I/O - Projector	Mitsubishi LVP-X100A
I/O - Parallel (Printer)	IBM Network Printer 17 CANON Color Bubble Jet BJC600 EPSON Stylus Color 740 EPSON, EPSON Color Imaging CANON, CANON LASER SHOT B406GII HP DeskJet 880C printer (USB) HP DeskJet 890C HP LaserJet 6MP CANON USB Printer
I/O - Parallel (Scanner)	Logitech PageScan Color HP ScanJet 3300C Color Scanner (USB) HP DeskJet 970Cxi Acer AcerScan Prisa 620s
I/O - USB	Sanwa USB HUB (self-power) USB, USB HUB 4 PORTS TI-CHIPS USB, USB HUB 4 PORT - ATMEL EIZO I. Station USB HUB ELECOM USB HUB 4-port

Item	Specifications
I/O - USB Modem	Best Data USB 56K V.90 Modem Speakerphone BLASTER USB BLASTER Modem 56K V.90
I/O - USB (Speaker)	JS USB Digital Speaker AIWA MultiMedia Digital Speaker System (USB)
I/O - USB (Joystick)	USB Rockfire Avant Garde Flightstick Microsoft SIDEWINDER Precision PRO (USB)
I/O - USB Camera	Intel Create and Share Camera Pack Intel Digital Camera Kodak DVC 300 (Digital-Video-Camera) Kodak USB-Base Camera IBM, IBM PS Camera
I/O Adapter	
PCMCIA - SCSI	Adaptec 1480A slim SCSI CB Adaptec SlimSCSI APA-1460AB NewMedia BUS Toaster PCMCIA to SCSI
PCMCIA - CDROM	IBM Portable 20x Speed CD-ROM Drive w/ SOUND (JP) Panasonic 4x Portable CD-ROM Sound Player Panasonic 20x Portable CD-ROM Player
PCMCIA - ATA	Sundisk ATA 15MB VIPER 170E IBM Travel Kit 340MB microdrive I.O Data HardDisk PC Card
PCMCIA - Other	Sony - DCR TRV - 10/ACCKIT M90 (1394 Camera) with Video Capture PC card DVBK-CW200
PCMCIA	
USB Device	Nokia Cellular Data Suite 1.2 (support IR) w/ 6150 Nokia Card Phone Nokia Cellular Data Card (PCMCIA) w/ 8110 or 6150 Motorola, Digital Cellular Fax and Data Modem CELLect 3 GSM/ DCS1800 w/ cd928+ Ericsson, Mobile Office DC23 w/ PH388 Ericsson Mobile Office D127 w/ GF768

Online Support Information

This section describes online technical support services available to help you repair your Acer Systems.

If you are a distributor, dealer, ASP or TPM, please refer your technical queries to your local Acer branch office. Acer Branch Offices and Regional Business Units may access our website. However some information sources will require a user i.d. and password. These can be obtained directly from Acer CSD Taiwan.

Acer's Website offers you convenient and valuable support resources whenever you need them.

In the Technical Information section you can download information on all of Acer's Notebook, Desktop and Server models including:

- Service guides for all models
- User's manuals
- Training materials
- Main manuals
- Bios updates
- Software utilities
- Schematics
- Spare parts lists
- Chips
- TABs (Technical Announcement Bulletin)

The service repair section provides you with downloadable information on:

- Troubleshooting guides
- Tooling box information
- Repair instructions for specific models
- Basic repair guidelines
- Debug cards for Acer's latest models

For these purposes, we have included an Acrobat File to facilitate the problem-free downloading of our technical material.

Also contained on this website are:

- Detailed information on Acer's International Traveler's Warranty (ITW)
- Returned material authorization procedures
- An overview of all the support services we offer, accompanied by a list of telephone, fax and email contacts for all your technical queries.

We are always looking for ways to optimize and improve our services, so if you have any suggestions or comments, please do not hesitate to communicate these to us.

A

AC Adapter 23
 AFLASH Utility 37
 Audio 21
 Auxiliary Input Device Check 70

B

Battery 22
 Battery Pack
 Removing 47
 battery pack
 charging indicator 10
 BIOS 17, 29
 BIOS Setup Utility 29
 BIOS Utility 29–36
 Navigating 29
 Block Diagram 3
 Board Layout 4
 Bottom View 5
 Top View 4
 Boot Display 32
 Boot Drive Sequence 32
 brightness
 hotkeys 13

C

caps lock 11
 on indicator 10, 26
 Changing a Password 36
 Check Procedures 70
 Battery 71
 Diskette Drive 70
 External CD-ROM Drive 70
 Keyboard 70
 Memory 71
 Power Adapter 71
 Power System Checkout 71
 Touchpad 72
 Combo Drive
 CD-ROM/ Floppy Drive 19
 DVD-ROM/Floppy Diskette 20
 computer
 on indicator 10
 performance 1

Wireless Communication indicator 10
 CPU Serial Number 34

D

Daughter and I/O board
 removing 62
 DC-AC LCD Inverter 23
 Diagnostics
 PQA 39
 Disassembly Procedure Flowchart 45
 Diskette
 System Diagnostics 39
 System Utility 38
 display
 hotkeys 13
 DMA Channel Assignment 27
 DVD-ROM and Floppy disk drive
 removing 49

E

EMI Plate
 removing 61
 Environmental Requirements 25
 Error Messages 74
 Error Symptoms 76
 Indicator 76
 LCD 76
 Memory 77
 PCMCIA 77
 Power 76
 Power Management 77
 Speaker 77
 Error Symptom-to-Spare Part Index 73
 ESD 24
 Euro 13, 14
 Extended Memory
 removing 51
 External Diskette Drive Check 70

F

Fan Utility 38
 Fast Boot 32
 Features
 Display 2

Flash Utility 37
FRU (Field Replaceable Unit) List 87

H

Hard disk drive
 disassembling 48
 removing 48
Hard Disk Password 34
Hardware Specifications and Configurations 17
HDD Interface 19
Heatsink
 removing 62
Hinge Cap
 removing 52
Hotkey Beep 32
hotkeys 13

I

I/O Address Map 26
I/O Ports 26
indicator lights 10
Indicators 10
Intermittent Problems 80
Inverter Board
 removing 54
IrDA Port 22
IRQ Assignment Map 27

J

Jumper and Connector
 Bottom View 85
 Top View 83
Jumper and Connector Information 83

K

Keyboard 11, 22
 removing 53
keyboard
 embedded numeric keypad 12
 hotkeys 13
 lock keys 11
 Windows keys 12
Keyboard Device Check 70
Keyboard Switch Settings 84

L

LAN Board
 removing 57
LAN Interface 18

LCD 23
 disassembly 52
LED Board
 removing 53
LEDs 10
Loading Default Settings 36
Lower Case
 removing 61

M

Machine Disassembly and Replacement 43
Main board
 removing 61
Main Board Data Utility 38
Main board Major Chips 17
Mechanical Specifications 26
media access
 on indicator 10
Memory 18
Memory Address Map 26
Memory Check 71
Memory Combinations 18
Microsoft Windows NT Environment Test 113
Middle Cover
 removing 52
Model Definition and Configuration 99
Modem Board
 removing 60
Modem Interface 19

N

num lock 11
 on indicator 10
numeric keypad
 embedded 12
 num lock 12

O

Onboard Devices Configuration 33
Online Support Information 117
OVP 24

P

Panel 6
Panel ID Utility 38
parallel port
 settings in BIOS Utility 33
PCMCIA Port 22
PCMCIA Slot

- removing 63
- POST 73
- Power Management
 - Display Standby Mode 25
 - Hard Disk Standby Mode 25
 - Hibernation Mode 25
 - Standby Mode 25
- Power System Check 71
 - Battery Pack 71
 - Power Adapter 71
- Power System Checkout 71
- Power-on Password 34
- PQA 39
 - diagnostics 39
- PQA Diagnostics Program 39
- Processor 17

R

- Removing a Password 35
- RMA 87

S

- scroll lock 11
- Second Level Cache 17
- Serial Port
 - settings in BIOS Utility 33
- Setup Password 34
- Speaker
 - removing 59
- speakers
 - hotkey 13
- Standby mode
 - status indicator 10, 26
- Startup Configuration 31
- status indicators 10
- System
 - Diagnostic Diskette 39
 - Utility Diskette 38
- System Check Procedures 70
- System Information 30
- System Security 34
- System Settings
 - Basic 31
- System Specifications 1
 - Features 1
- System Upgrade

- Base Unit to Bluetooth Unit 64
- Base Unit to Wireless LAN Unit 65
- Wireless LAN to Wireless LAN and Bluetooth Combo Unit 66

- System Upgrade Procedure 64
- System Utilities 29

T

- Test Compatible Components 103
- Thermal Utility 38
- Touchpad
 - removing 59
- touchpad 15
 - hotkey 13
 - using 15–16
- Touchpad Check 72
- Troubleshooting 69

U

- Undetermined Problems 80
- Upper Case
 - removing 58
- USB Port 22
- utility
 - BIOS 29–36
- UUID 38

V

- Video 21
- Video Capture Kit
 - removing 50
- Video Memory 21
- Video Resolutions Mode 21
- view
 - bottom 9
 - front 7
 - left 7
 - rear 8
 - right 7

W

- Windows 2000 Environment Test 107
- Windows 98 Environment Test 104
- Windows keys 12
- Windows Millenium Environment Test 110
- Wireless LAN Interface 18

