

Maintenance Manual

Extensa™ 57x Series Notebook Computers

9811323-0001

May 1996



**Copyright (©) 1996 Texas Instruments Incorporated
All Rights Reserved — Printed in U.S.A.**

**Extensa™ 57x Series Notebook Computers
Maintenance Manual
TI Part No. 9811323-0001
Original Issue: May 1996**

Changes may be made periodically to the information in this publication. Such changes will be incorporated in new editions of this manual.

No part of this publication may be reproduced, stored in a retrieval system, or transmitted, in any form or by any means, electronic, mechanical, photocopy, recording, or otherwise, without the prior written permission of Texas Instruments Incorporated.

The equipment, as well as the programs that TI has created to use with them, are tools that can help people better manage the information used in their business; but tools — including TI products — cannot replace sound judgment nor make the manager's business decisions.

Consequently, TI cannot warrant that its products are suitable for any specific customer application. The manager must rely on judgment of what is best for his or her business.

Address all correspondence regarding orders to:

**Texas Instruments Incorporated
P.O. Box 6102, M/S 3255
Temple, Texas 76503**

Extensa and DockMate are trademarks of Texas Instruments.

The icons in the Windows Notebook and Startup groups are copyrighted by Texas Instruments.

Lotus is a trademark of Lotus Development Corporation.

IBM and VGA are trademarks and PS/2 is a registered trademark of International Business Machines Corporation.

Microsoft, Windows, and MS-DOS are registered trademarks of Microsoft Corporation.

Intel and Pentium are registered trademarks of Intel Corporation.

Cirrus and SimulSCAN are trademarks of Cirrus Logic, Inc.

IRDA is a trademark of Infra Red Data Association.

Preface

1 General Description

1.1	Introduction	1-1
1.2	Product Models	1-1
1.3	International Product Versions	1-2
1.4	Product Overview	1-3
1.4.1 . . .	External Ports	1-5
1.4.2 . . .	Glidepad Pointing Device	1-6
1.4.3 . . .	Keyboard	1-6
1.4.4 . . .	Standard Power Features	1-7
1.4.5 . . .	Wireless Connection With Serial Infrared Port . . .	1-8
1.4.6 . . .	Preloaded Software	1-8
1.4.7 . . .	Notebook Expansion Capabilities	1-8
1.5	Standard Test Features	1-9
1.6	Notebook Assemblies and Subassemblies	1-9
1.6.1 . . .	Cover-Display Assembly	1-10
1.6.2 . . .	System Base Assembly	1-11
1.7	Extensa 57x Series Notebook Specifications	1-11
1.8	Agency Approvals	1-13

2 Installation

2.1	Introduction	2-1
2.2	Unpacking Instructions	2-1
2.3	Installing Notebook Options	2-1
2.3.1 . . .	Installing Expansion Memory Modules	2-1
2.3.2 . . .	Installing PCMCIA Options	2-2
2.3.3 . . .	Installing the Optional Numeric Keypad	2-2
2.4	Installing the Battery Pack(s)	2-2
2.5	Installing External Devices	2-3

2.5.1 . . . Installing an External Keyboard/Mouse	2-4
2.5.2 . . . Installing External Parallel Printer	2-6
2.5.3 . . . Installing External Serial Port Device	2-7
2.5.4 . . . Installing External SVGA Monitor	2-8
2.5.5 . . . Installing SIR Devices.	2-9
2.6 Installing the AC Power Adapter	2-10
2.7 Initial System Checkout	2-10
2.8 Configuring the System.	2-11
2.9 Making Backups of System Software.	2-11
2.10 . . . Loading Application Software	2-11

3 Operating Instructions

3.1 Introduction	3-1
3.2 Notebook Controls and Indicators	3-1
3.2.1 . . . LCD Contrast Control	3-2
3.2.2 . . . Button Switches.	3-2
3.2.3 . . . Cover Release Latch.	3-2
3.2.4 . . . Glidepad Controls	3-2
3.3 Operating Procedures	3-2
3.3.1 . . . Floppy Drive Operating Procedures	3-2
3.3.2 . . . Installing/Removing PCMCIA Options	3-4
3.3.3 . . . Computer Hot Keys	3-4
3.3.4 . . . Responding to Low Battery Conditions.	3-4
3.3.5 . . . Minimizing Power Usage.	3-4
3.3.6 . . . Recharging the Battery Packs.	3-5
3.3.7 . . . Conditioning the Primary Battery.	3-5
3.3.8 . . . Restoring Missing System Files	3-5
3.3.9 . . . Rebuilding the System Software.	3-5

4 Theory of Operation

4.1 Introduction	4-1
4.2 Notebook Functional Description.	4-1
4.2.1 . . . Processor/Memory Subsystems	4-1
4.2.2 . . . I/O Subsystem.	4-5
4.2.3 . . . Video Subsystem.	4-6

4.2.4 . . .	Hard Disk Subsystem	4-6
4.2.5 . . .	Floppy Diskette Drive Subsystem.	4-7
4.2.6 . . .	CD-ROM Subsystem	4-7
4.2.7 . . .	PCMCIA Subsystem	4-7
4.2.8 . . .	Sound Subsystem (Model Dependent)	4-8
4.2.9 . . .	Power Subsystem.	4-8

5 Troubleshooting Procedures

5.1	General	5-1
5.2	Overview of Fault Isolation Process	5-1
5.3	Troubleshooting Procedures	5-3
5.3.1 . . .	Troubleshooting a Power Supply Problem.	5-3
5.3.2 . . .	Troubleshooting a Display Problem	5-5
5.3.3 . . .	Fault Isolation Using Self Test	5-5
5.3.4 . . .	PCMCIA Modem Problems	5-5
5.3.5 . . .	Fault Isolation Using Diagnostics	5-6

6 Field Service

6.1	Introduction	6-1
6.2	Preventive Maintenance.	6-1
6.2.1 . . .	Cleaning the Computer	6-1
6.2.2 . . .	Protecting the Disk Drives	6-1
6.2.3 . . .	Handling the Computer Battery Pack.	6-2
6.2.4 . . .	Restoring System Software.	6-2
6.3	Required Tools and Equipment	6-2
6.4	Notebook Field-Replaceable Parts and Assemblies.	6-3
6.4.1 . . .	Cover-Display Assembly.	6-3
6.4.2 . . .	System Base Assembly.	6-5
6.5	FRU Removal and Replacement Procedures.	6-8
6.5.1 . . .	Removing/Replacing the Notebook Battery Pack	6-8
6.5.2 . . .	Removing/Replacing the Floppy Drive/CD-ROM	6-8
6.5.3 . . .	Removing/Replacing the Hard Drive	6-9
6.5.4 . . .	Removing/Replacing DIMM Modules	6-9
6.5.5 . . .	Removing/Replacing the Keyboard Assembly	6-10
6.5.6 . . .	Removing/Replacing the Display Assembly	6-11

6.5.7 . . . Removing and Replacing the LCD Status Assembly	6-11
6.5.8 . . . Removing/Replacing the Top Case Assembly	6-12
6.5.9 . . . Removing/Replacing the Glidepad Assembly	6-12
6.5.10 . . Removing/Replacing the IR/Sound Assembly	6-12
6.5.11 . . Removing/Replacing the Power Supply Board	6-13
6.5.12 . . Removing/Replacing the CMOS Battery	6-13
6.5.13 . . Removing/Replacing the Main Board	6-13
6.5.14 . . Removing/Replacing HDD Connector Board	6-14
6.5.15 . . Removing/Replacing Inverter Board	6-15

A Self Test Error Messages

A.1 Introduction	A-1
------------------------------------	-----

B PC-Doctor Diagnostics

B.1 Introduction	B-1
B.2 Starting PC-Doctor	B-1
B.3 Keyboard Navigation	B-2
B.4 Mouse Navigation	B-2
B.5 PC-Doctor Menus	B-3
B.5.1 . . . Online Help (?)	B-3
B.5.2 . . . Diagnostics	B-3
B.5.3 . . . Interactive Tests Menu	B-4
B.5.4 . . . Hardware Info Menu	B-4
B.5.5 . . . Utility Menu	B-5
B.6 Quitting PC-Doctor	B-6
B.7 Remote Operation	B-6

Introduction

This manual provides installation, operation and servicing data for the Extensa™ 57x Series Notebook Computers.

Intended Audience

This manual is primarily intended for use by qualified service technicians but contains information useful to non-technical users.

Contents

This manual contains six sections and reference appendices including:

- **Section 1: General Description** — Introduces the main features of the notebook; provides a list of physical and electrical specifications.
- **Section 2: Installation** — Describes how to unpack, install options and cable up the notebook computer in a desktop environment.
- **Section 3: Operating Instructions** — Describes the notebook operating controls and indicators and basic operating procedures.
- **Section 4: Theory of Operation** — Describes the theory of operation for Extensa 57x Series Notebook Computers.
- **Section 5: Troubleshooting Procedures** — Provides guidelines for performing fault isolation on the Extensa 57x Series Notebook Computers.
- **Section 6: Field Service** — Provides preventive and corrective maintenance procedures for the notebook computer.
- **Appendix A: Self Test Error Messages**
- **Appendix B: PC-Doctor Diagnostics**

Other Manuals About the System

The following documents provide additional information related to the Extensa 57x Series Notebooks:

- **Extensa™ 57x Series Notebook Computer User's Reference Manual**, contains reference information regarding the Extensa 57x series software.
- **Windows 95® Help** (online)
- **PC-Doctor Help and Technical Reference** (online)

Ordering Parts and Supplies

To order a copy of any TI publication or to order option kits, spare parts or supplies for your system, contact your TI Reseller or:

Telephone Toll-free: **1-800-TI TEXAS**

General Description

1.1 Introduction

This manual contains field and factory level servicing information for the Texas Instruments Extensa™ 57x Series of Notebook Computers (Figure 1-1).

This section provides a general overview and specifications for the Extensa 57x Series Notebook Computers.

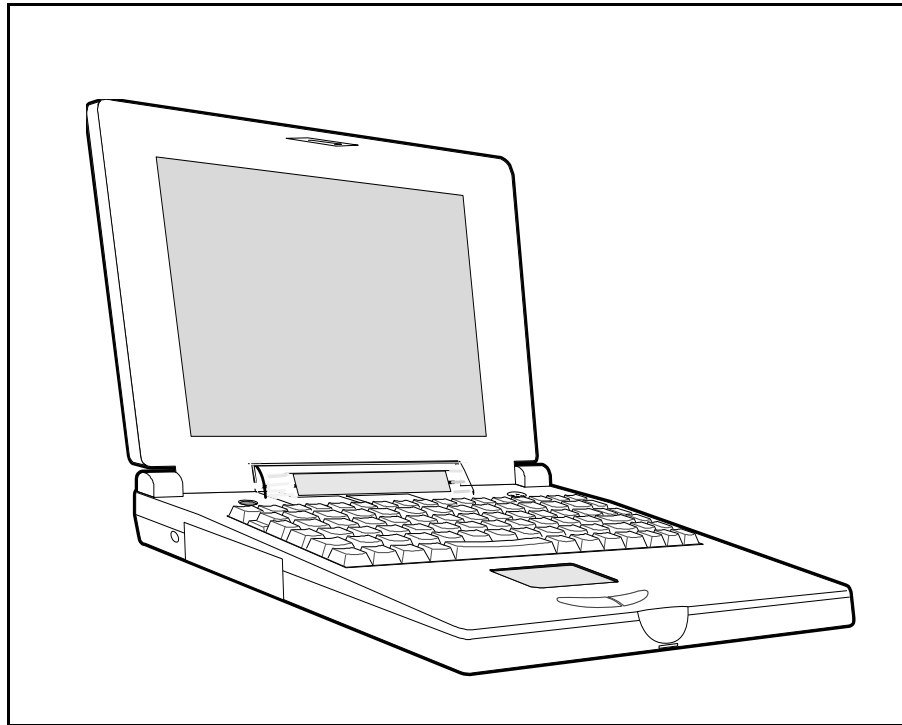

Figure 1-1 Extensa 57xSeries Notebook Computer

1.2 Product Models

Table 1-1 summarizes the features shipped with the notebook for the product models initially available in the Extensa 57x family of notebook computers. The product models offer a choice of either 11.3 inch, dual scan color or 10.4 inch active matrix color LCD and a choice of either the basic Windows® 95 operating system or Windows 95 plus application software. Other options include choice of 810 million byte or 1200 million byte hard drive.

Table 1-1 Extensa 57x Series Notebook Computers

Features	Model 570CD	Model 575CD	Model 570CDT	Model 575CDT
11.3" Dual Scan, SVGA Color LCD	X	X		
10.4" Active Matrix (TFT), SVGA Color LCD			X	X
1.44 MB Floppy Drive Module	X	X	X	X
CD-ROM Drive Module	X	X	X	X
Windows 95	X	X	X	X
Application Software		X		X
16-Bit Stereo Sound	X	X	X	X
HDD 810 Million Bytes	X	X		
HDD 1200 Million Bytes			X	X

1.3 International Product Versions

The Extensa 57x Series Notebooks are available in domestic and international configurations as listed in Table 1-2.

Table 1-2 Notebook Domestic/International Configurations

Configuration	P/N Suffix	Configuration	P/N Suffix
Domestic	-0001	Swedish	-0010
UK	-0002	Swiss/French	-0011
German	-0003	Danish	-0012
French	-0004	Norwegian	-0013
Spanish	-0005	Finish	-0014
Swiss/German	-0006	Belgium	-0015
Italian	-0007	Austrian	-0016
Portuguese	-0008	Latin American	-0018
Western European	-0009		

1.4 Product Overview

All members of the Extensa 57x Series are high performance notebooks powered by the Pentium™ Processor and Windows 95 Operating System software.

As a standard feature, all members of the Extensa 57x family also contain the following features:

- 100 MHz Pentium Processor with 16K Internal Cache Memory.
- 8 MB of RAM memory standard, user-expandable to 40 MB (easy access via door at bottom of notebook).
- 256 KB L2 Cache.
- 128 bytes of battery-backed up CMOS RAM.
- High performance PCI (Peripheral Component Interconnect) Bus Architecture; PCI Bus Expansion port for use with optional Expansion System.
- Removable Hard Disk Drive (810 or 1200 million byte capacity).
- Removable 1.44 MB Floppy Drive (interchangeable with optional CD-ROM Drive or Lithium-Ion secondary battery pack).
- Two PCMCIA option slots (one slot accepts one Type I/II option and the second slot accepts either a Type I, II, or III device).
- Ergonomic keyboard with palm rest (2.7 mm travel); built-in glidepad pointing device and palm rest below the keyboard.
- Built-in support for a CD-ROM drive (4X or 6X speed).
- Built-in 16-bit stereo sound system (including stereo speakers and internal microphone)
- Removable 3.5 inch, 1.44 MB Floppy Drive (interchangeable with second Lithium-Ion battery or CD-ROM option).
- Choice of LCD displays: 10.4 inch Active Matrix (TFT), SVGA Color LCD or 11.3 inch, dual scan, SVGA color LCD; 1 MB video RAM.
- Support for internal SVGA LCD display only, external SVGA Monitor only, or simultaneous SVGA LCD and external SVGA monitor.
- LCD Status Panel displays icons to indicate when AC adapter is plugged in, power savings mode is on, battery in use (blinks if battery is low), floppy drive in use, hard disk activity indicator, PCMCIA cards installed, CD-ROM drive activity, and keyboard modes (e.g.. Num Lock, Caps Lock, Scroll Lock, Pad Lock etc.).

- AC Adapter with autosensing (100 VAC to 240 VAC, 50 to 60 Hz); 36 Watts of DC output power.
- 8.4 Volt, 4200 mAH capacity, Nickel-Metal Hydride (NiMH) primary battery pack.
- Provisions for secondary 10.8 Volt Lithium-Ion Battery Pack in Floppy Drive cavity (if Floppy Drive or CD ROM Player not installed).
- Power management features for longer portable operation away from AC power.
- Full range of external ports including: EPP/ECP Parallel Port, Serial Port, External VGA Port, PS/2™ Port, and Serial Infrared Port. All Models of the 57x family include Audio In/Out and Microphone In jacks.

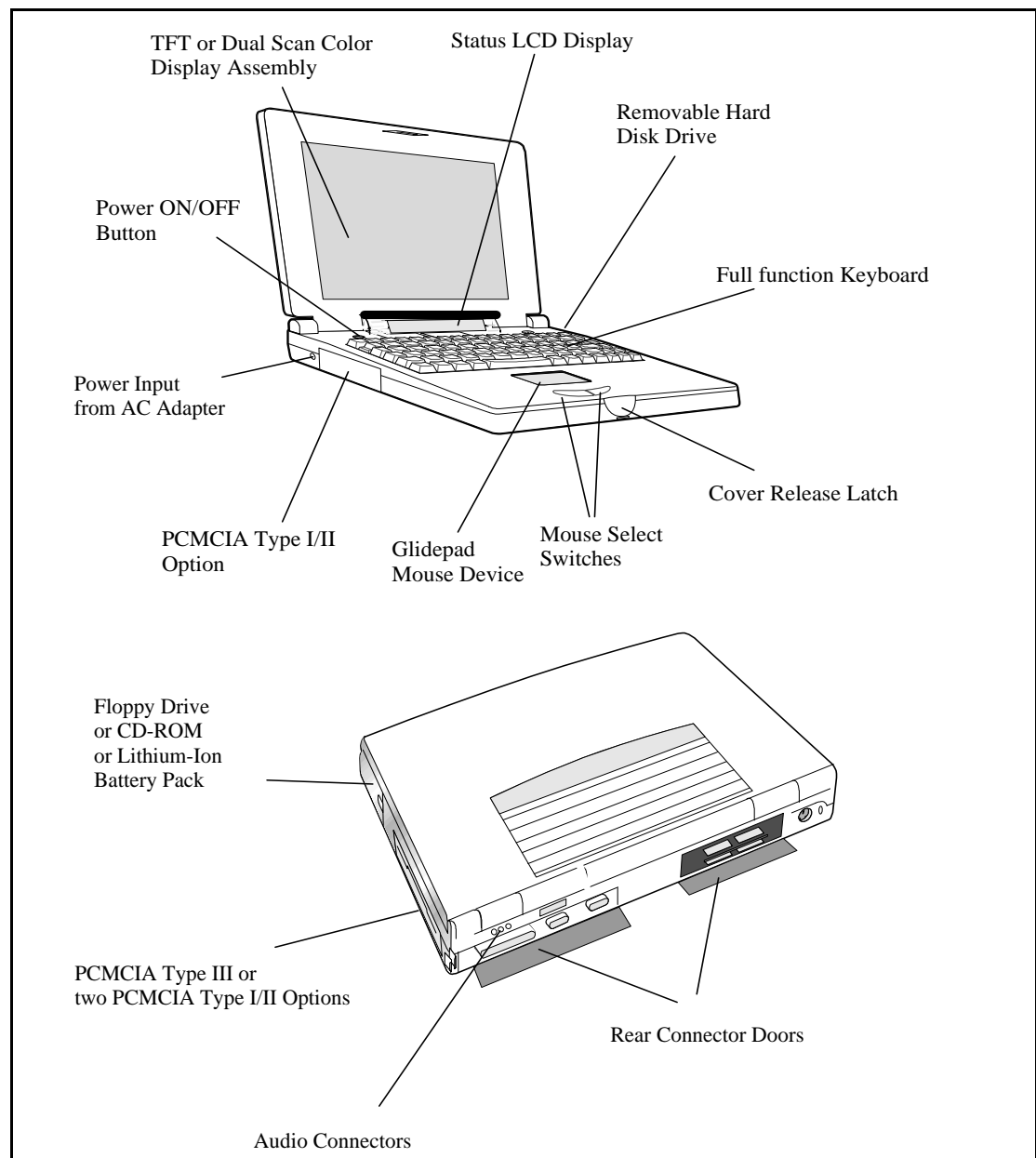

Figure 1-2 Extensa 57X Series Features

1.4.1 External Ports

As shown in Figure 1-3, the notebook computer contains the following external ports:

- Serial Infrared (SIR) Port for wireless connection with a similarly equipped printer or computer
- 9-Pin Serial Port for attaching any RS-232 type serial device to the Notebook
- 15-Pin External VGA Monitor Port for attaching an external monitor
- 6-Pin PS/2 Port to attach an external Keyboard or Mouse
- Audio In/Out and External Microphone Input
- Expansion Bus Port for attaching an external expansion system

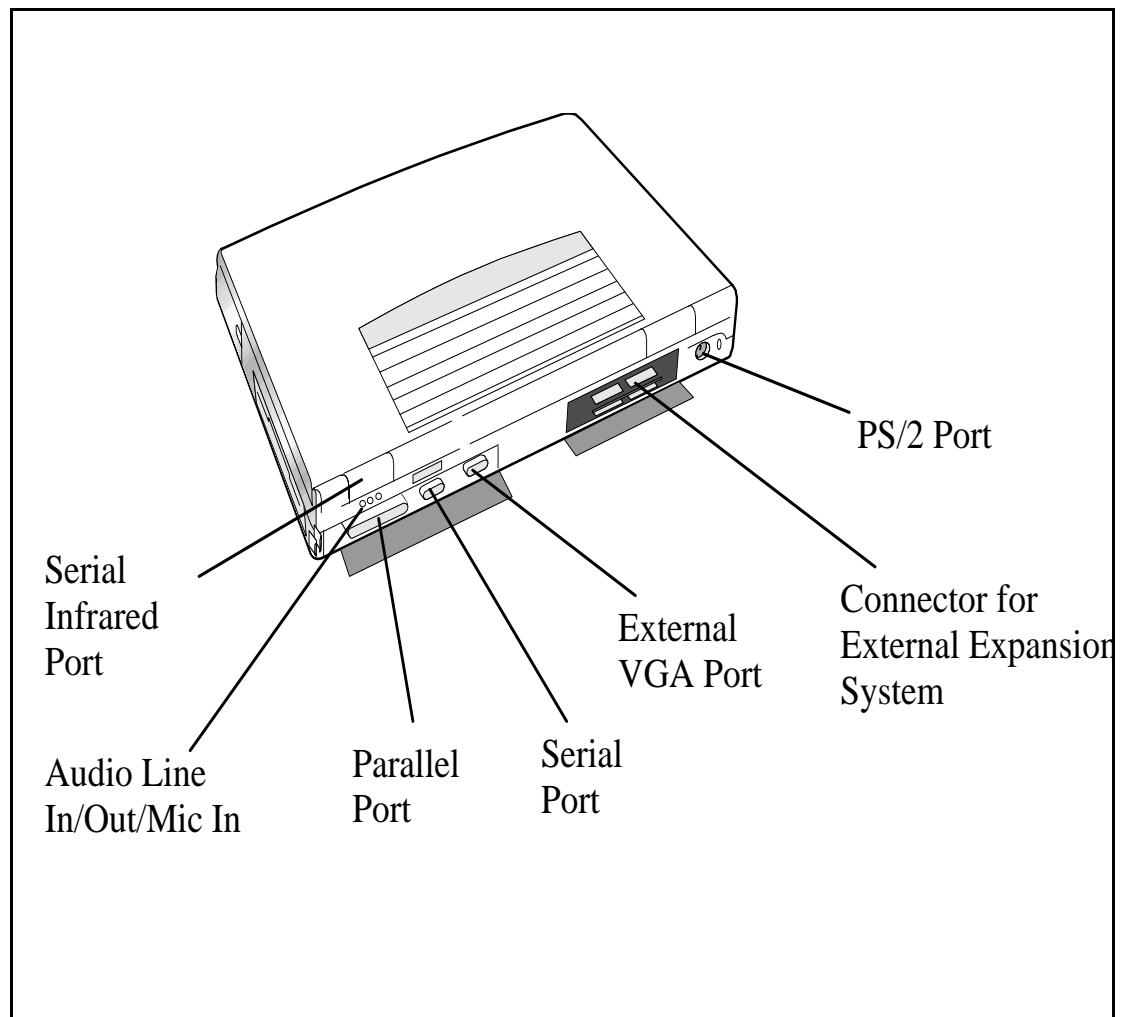

Figure 1-3 Notebook External Ports

1.4.2 Glidepad Pointing Device

All members of the Extensa 57x family feature a built-in glidepad pointing device located near the center of the keyboard's palmrest. With light finger pressure, the cursor can quickly be positioned to the desired point; a quick double tap on the glidepad and you have selected an object. Two select buttons (switches) are located along the front edge of the notebook for use in the traditional select/drag features of a mouse device.

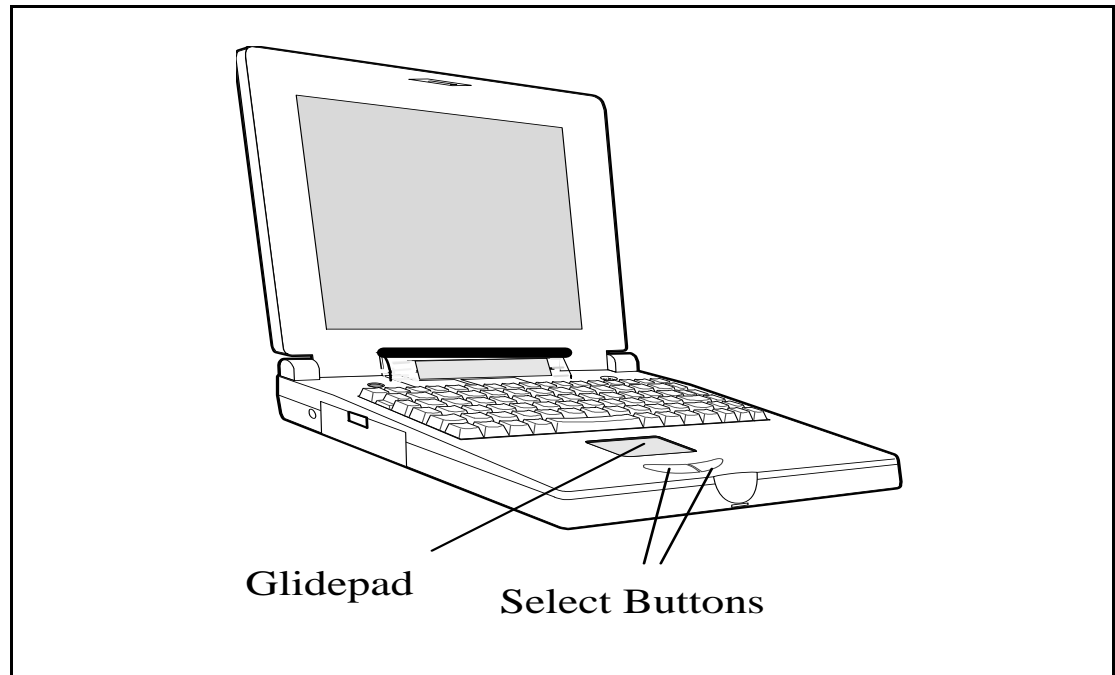

Figure 1-4 Extensa 57X Series Glidepad

1.4.3 Keyboard

The Extensa 57x Series Keyboard is a full function keyboard with the standard character and function keys plus 12 programmable function keys (F1 through F12).

Using the Special Function (**Fn**) key which assigns multiple functions to keys, the keyboard can emulate IBM® 101/102 keyboards.

The notebook keyboard is available in two basic versions:

- U.S. English - This version (also known as the domestic version) is generally used in the United States and Canada.
- U.K. English/Custom International Version - This version is adapted (using appropriate keycap changes) for the international countries listed in Table 1-2.

n

Note: The *Extensa Series Notebook Computer User's Reference Manual* contains descriptions of keyboard special function keys.

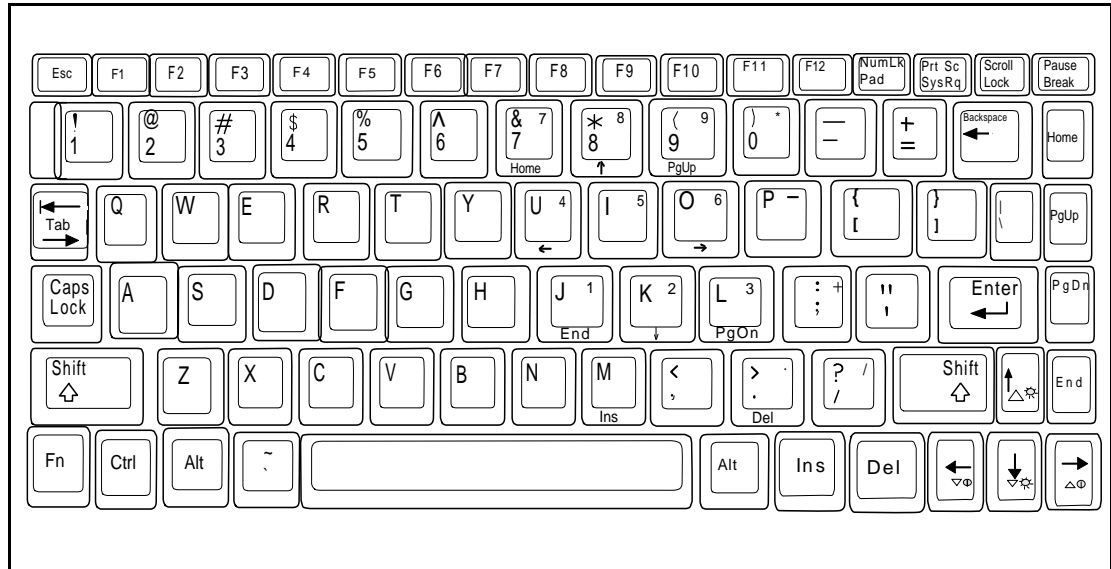

Figure 1-5 Extensa Keyboard

1.4.3.1 Controls and Indicators

The Extensa 57x contains a Power Button and a Status LCD just above the keyboard. All notebook functions (except the power On/Off function) are controlled by keyboard keys in conjunction with the **Fn** key.

1.4.4 Standard Power Features

Notebook power for the Extensa 57x Series Notebook Computers is provided by an AC Adapter and a rechargeable nickel metal hydride (NiMH) battery pack that installs in a power bay near the front of the notebook (right side).

A second lithium ion battery may optionally be installed in the Floppy Drive bay when the Floppy Drive is removed from the Notebook.

All members of the Extensa 57x family feature a power management subsystem (hardware and software) that provides for longer portable operation and protection of files during low battery conditions.

n

Note: The Nickel Metal Hydride (NiMH) battery requires periodic battery conditioning in order to charge to full capacity. To accomplish this, remove the AC Adapter and the secondary battery pack (if installed). Allow the notebook to deep discharge. Then, recharge to full capacity. The secondary battery pack is a Lithium-Ion type that does not require conditioning.

1.4.5 Wireless Connection With Serial Infrared Port

The Extensa Series notebooks are equipped with a Serial Infrared (IR) port that offers wireless communication with a variety of IRDA™ compliant devices made by other manufacturers.

n

Note: Prior to communicating with an external device equipped with a serial infrared interface, the appropriate third-party drivers must be installed on your notebook.

1.4.6 Preloaded Software

All members of the Extensa 57x Notebook family are preloaded with the Windows 95 Operating System. In addition, Extensa 575CD and 575 CDT models come standard with the following application packages installed:

- Microsoft™ Works
- Quicken SE
- Lotus™ Organizer
- Microsoft Entertainment Pack No. 4

1.4.7 Notebook Expansion Capabilities

Expansion capabilities built into the Extensa notebook series include:

- User installable expansion RAM memory (to a maximum of 40 MB)
- By removing the floppy drive, you can add either a second battery pack or CD-ROM Drive.
- Cable Connect PS/2 Numeric Keypad option, TI Part No. 2581381-0001, or other PS/2 type device (e.g. keyboard or mouse) can be attached to the PS/2 Port.
- A parallel device can be attached to the notebook's external 25-pin parallel port (EPP/ECP compatible).
- With one of the DockMate desktop expansion systems installed, additional expansion ports are available

1.5 Standard Test Features

The Extensa Series Notebook Computers use modular design and built-in test features to reduce the mean time to repair. A power on self test program automatically verifies the operational state of the primary circuits. Also, the notebook contains a powerful suite of diagnostic tests called PC-Doctor, (described in detail in Appendix B) that can perform additional levels of diagnostic testing.

1.6 Notebook Assemblies and Subassemblies

The Extensa Series Notebooks are modular in design and can be disassembled for maintenance purposes using a standard set of flat-bladed, Phillips-head and hexagonal screwdrivers. The major assemblies that comprise a typical notebook in the Extensa family are shown in Figure 1-6 and briefly described in the following paragraphs.

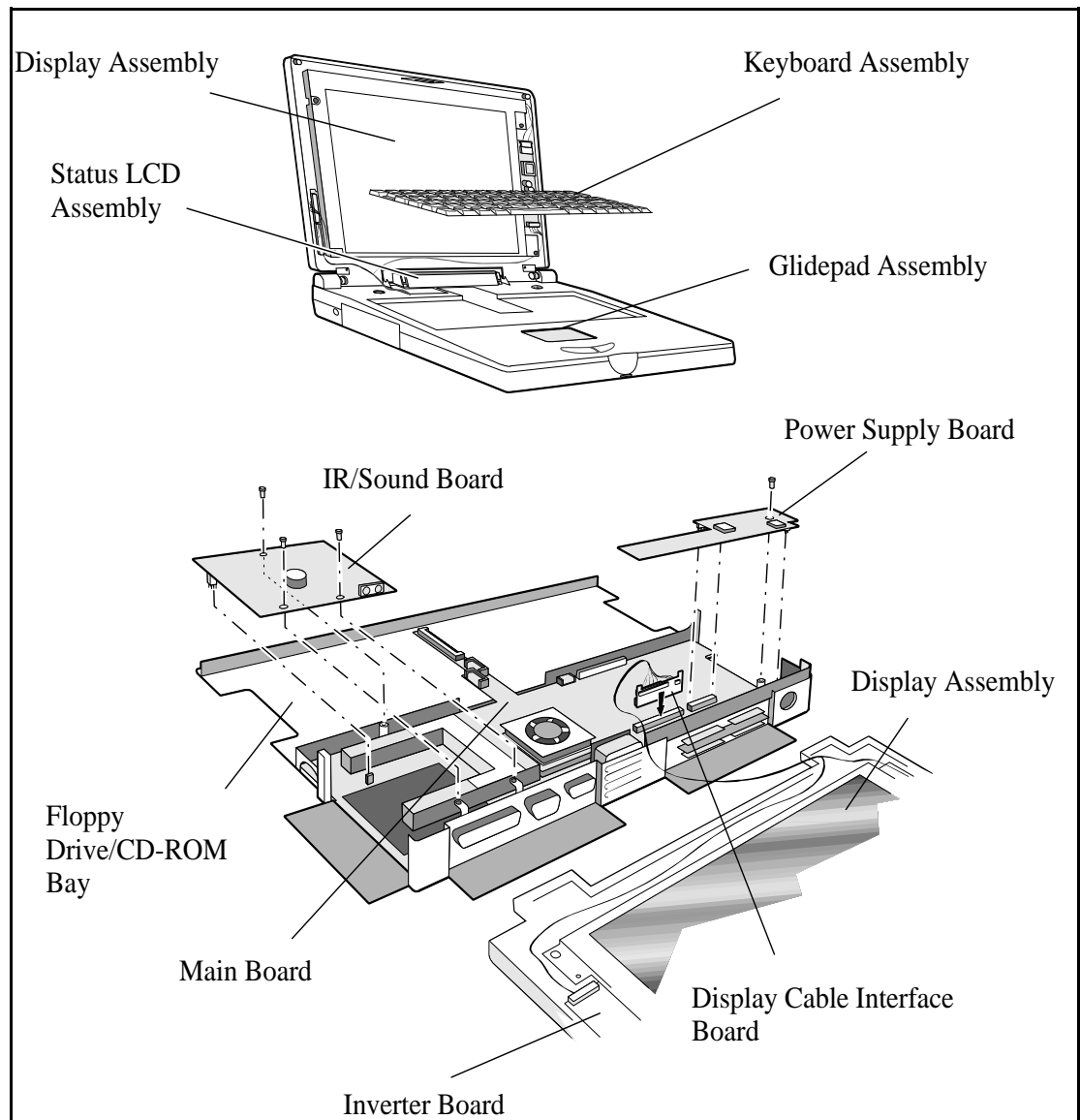

Figure 1-6 Notebook Assemblies

1.6.1 Cover-Display Assembly

The Cover-Display Assembly contains the LCD screen and associated high voltage power supply and video circuitry. The Cover-Display Assembly contains several field-replaceable components including:

- LCD Assembly
- Inverter Board
- Bezel
- Hinge Covers
- Internal cables

1.6.2 System Base Assembly

As shown in Figure 1-6, the majority of the notebook's field replaceable units (FRUs) are located in the system base assembly. These FRUs include:

- Main Board Assembly
- Hard Disk Drive Assembly
- Up to two Dual Inline Memory Modules
- LCD Status Assembly
- Floppy Drive Module
- IR/Sound Board Assembly
- Power Supply Board Assembly
- Battery Pack Assembly
- Top Case Assembly
- Glidepad Assembly
- Keyboard Assembly
- CMOS Battery Assembly
- HDD Connector Board Assembly

1.7 Extensa 57x Series Notebook Specifications

Specifications for the Extensa 57x Series Notebooks are provided in Table 1-3.

Table 1-3 Extensa 57x Notebook Features

Specifications	Models 570CD/575CD	Models 570CDT/575CDT
Processor	Pentium 100 MHz	Pentium 100 MHz
Memory: Standard:	8 MB	8 MB
Maximum: Cache:	40 MB 256 KB L2 Cache	40 MB 256 KB L2 Cache
Display		
LCD Type:	11.3 inch, SVGA, Dual Scan Color	10.4 inch, SVGA, Dual Scan Color/ Active Matrix Color
Simultaneous LCD/Ext. SVGA	Yes	Yes
Video RAM Size:	1 MB	1 MB
Video Bus	PCI Bus with Graphics Accelerator	PCI Bus with Graphics Accelerator
Keyboard/Pointing Device		
Ergonomic Keyboard	Yes	Yes
Built-In Glidepad	Yes	Yes
Storage		
Floppy Drive Module:	3.5 inch, 1.44 MB	3.5 inch, 1.44 MB
Hard Drive:	810 Million Bytes	1200 Million Bytes
CD-ROM Drive	4X or 6X Speed	4X or 6X Speed
Interfaces		
Serial (RS-232) Port	Yes	Yes
Parallel Port (EPP/ECP)	Yes	Yes
External VGA Port	Yes	Yes
External PS/2 Port	Yes	Yes
Serial Infrared Port	Yes	Yes
Expansion Bus	PCI, supports Port Replicator option	PCI, supports Port Replicator option

Specifications	Models 570CD/575CD	Models 570CDT/575CDT
Battery Pack	Nickel-Metal Hydride, optional Lithium-Ion secondary battery pack option	Nickel-Metal Hydride, optional Lithium-Ion secondary battery pack option
Sound Features	16-bit Stereo Sound, Audio in/out and Microphone In jacks, built in stereo speakers and microphone	16-bit Stereo Sound, Audio in/out and Microphone In jacks, built in stereo speakers and microphone
PCMCIA Support	Type I/II, or III (Optional)	Type I/II, or III (Optional)
Windows 95	Yes	Yes
Windows for Workgroups	Yes (Model 570CD only)	Yes (Model 570CDT only)
Physical Characteristics		
Weight:	Approx. 6.2 Pounds*	Approx. 6.2 Pounds*
Dimensions:	11.7" (L) X 1.7" (H) X 8.2" (W)	11.7" (L) X 1.7" (H) X 8.2" (W)
<p>*NOTE: Only one module (Floppy Drive, CD-ROM or second Battery) may be installed in the notebook at any given time.</p> <p>NOTE: Weight specifications do not include Floppy Drive, CD-ROM drive, AC Adapter or second battery option.</p>		

1.8 Agency Approvals

All Extensa 57x Series products meet the following standards:

- Underwriter's Lab (UL) Standard 1950 (safety)
- Canadian Standards Association (CSA) Standard 220 (safety)
- FCC CFR 47, Part 15, Subpart J, FCC Level B (EMI)
- Canadian Department of Communications (DOC) Certification
- VDE 0871, Class B (EMI)
- CE Mark

Installation

2.1 Introduction

This section contains unpacking and preparation for use instructions for the Extensa 57x Series Notebook Computers.

2.2 Unpacking Instructions

Unpack the computer using the following instructions:

1. Carefully cut the tape that seals the top flap of the shipping carton.
2. Remove the computer and the accessories from the main shipping carton.
3. Remove all protective coverings from the computer.
4. Remove the holding tape and open up the accessory box; remove the contents.

n

Note: Save the shipping containers and packaging for later reuse.

2.3 Installing Notebook Options

If you have no options to install at this time, skip to Paragraph 2.4. Otherwise, continue with Paragraph 2.3.1.

2.3.1 Installing Expansion Memory Modules

n

Note: If not installing RAM Expansion option at this time, skip to the next paragraph.

C

Caution: The Dual Inline Memory Module contains components that are sensitive to static electricity. When handling the module and the internal parts of the computer, protect against static electricity by using wrist or ankle grounding straps and grounded working mats. When moving or storing items, use the anti-static bags supplied with the items.

-
1. Ensure that the notebook is powered off and that the AC Adapter and internal battery pack(s) is (are) removed from the notebook.
 2. Remove the Expansion RAM Module (Dual Inline Memory Module or DIMM) from its shipping container.
 3. Turn the Notebook over and locate the RAM Access Door (held in place by two screws).
 4. Remove the two Phillips-head screws that hold the RAM access door and remove the door.
 5. Insert the edge of the first DIMM Board into the rear of either available connector . Use a rocking motion and insert the board at an angle to the surface of the Main Board. Fully insert the module. Push downwards on each side of the DIMM module until it snaps in place. Repeat the procedure for the second module.
 6. Replace the RAM Access Door and all components removed in Step 1.
- This completes the expansion memory module installation procedure.

2.3.2 Installing PCMCIA Options

The Notebook has provisions for two Type I or II options or one Type III PCMCIA option card.

1. Review the installation instructions supplied with the PCMCIA option card(s).
2. Open the PCMCIA compartment cover on the right side of the notebook.
3. To insert a PCMCIA card, align the card with the socket and slide the card into the socket until it locks into place.
4. To eject a PCMCIA card, first ensure that the notebook is not accessing the memory card or device. Under Windows 95, go to the Control Panel, PC Card selection and direct the card to stop before removing card.

2.3.3 Installing the Optional Numeric Keypad

An optional numeric keyboard can be attached to the notebook via the notebook's PS/2 connector (refer to Figure 2-2).

2.4 Installing the Battery Pack(s)

The Extensa Notebook is shipped with a single battery pack that is inserted from the front left side of the computer. A second battery pack (option) can

be installed in the removable Floppy/CD-ROM bay. Two switches that used to remove devices from the option bay are physically located on the bottom of the Notebook. The left-most switch controls removal of the Primary Battery Pack and the right-most switch controls removal of the device installed in the Floppy/CD-ROM/Secondary Battery bay.

To remove or replace the battery pack, follow the steps below.

1. Save any data, then Power off the notebook. Disconnect the AC adapter if installed.
2. Turn the notebook over and press the battery release switch while pressing outwards on the primary battery pack. Remove the battery from the Notebook.
3. Insert a new or recharged battery pack into the battery compartment bay. Make sure that the contacts are facing up and to the rear of the compartment.

C

Caution: There is danger of explosion if the battery is incorrectly replaced. Replace the battery only with the same or an equivalent type recommended by the manufacturer. Discard used batteries according to the manufacturer's instructions.

4. If installing a secondary battery pack, insert the battery pack into the front right side of the notebook until the battery pack clicks in place.

2.5 Installing External Devices

Most external devices connect to the Notebook via the connectors on the rear of the notebook as shown in Figure 2-1. Additional connectivity can be obtained by installing an optional Port Expander to the Notebook's PCI Expansion Bus.

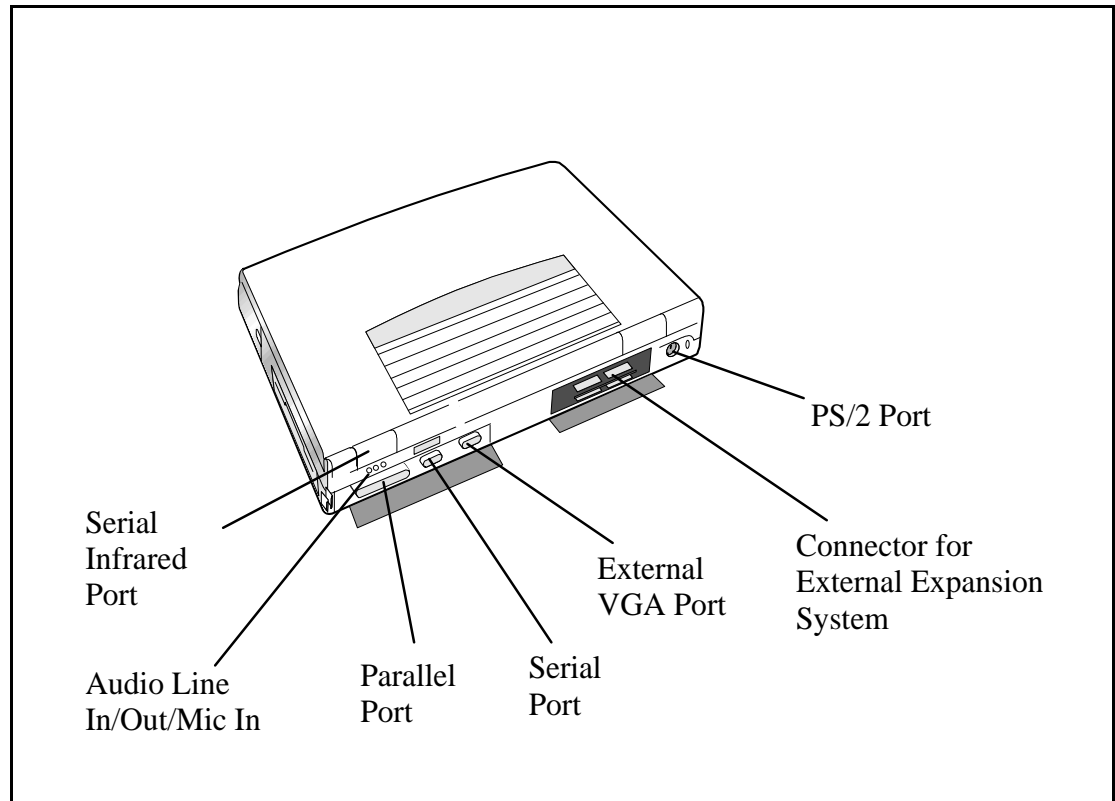

Figure 2-1 I/O Connector Locations

2.5.1 Installing an External Keyboard/Mouse

As shown in Figure 2-2, the notebook has one external PS/2 port on the rear of the Notebook for installing a PS/2 compatible device (keyboard, mouse, etc.). Additional PS/2 devices may be installed using the Port Expander option. Pinouts for the PS/2 port on the rear of the Notebook are also provided in Figure 2-2.

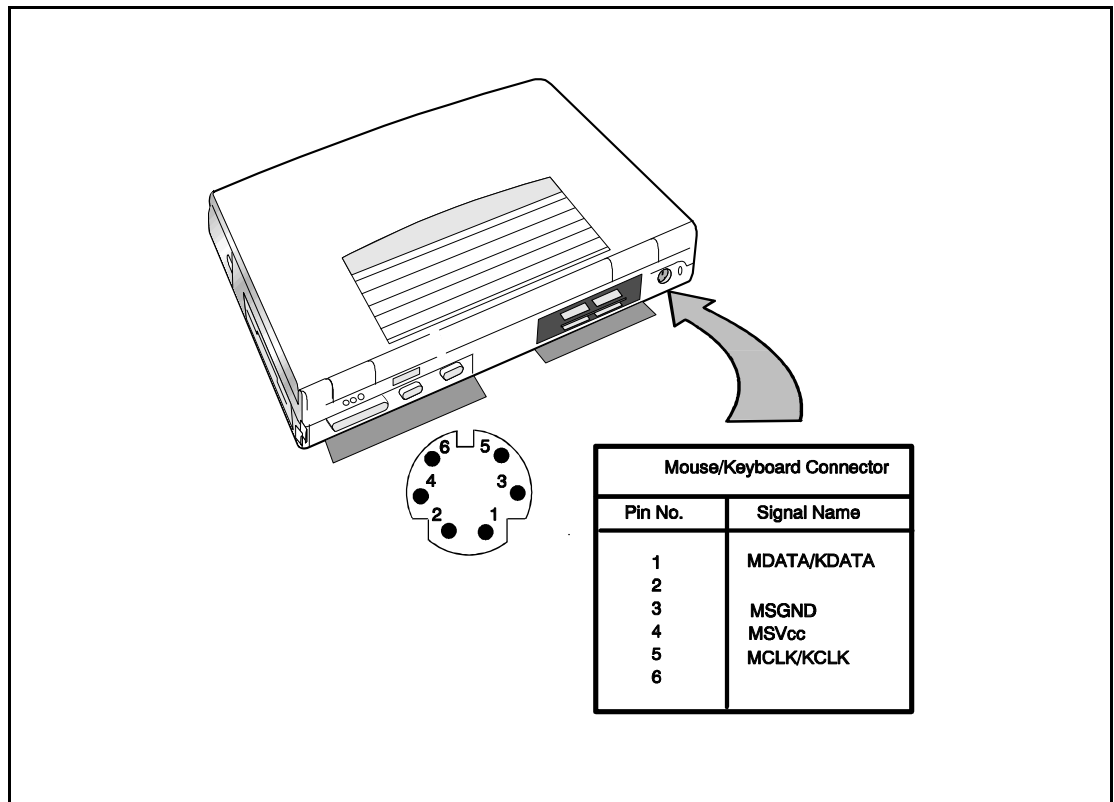

Figure 2-2 PS/2 Port Assignments/Pinouts

To install an external keyboard or external PS/2 mouse on the notebook, use the following procedure:

1. Ensure that the notebook is powered off.
2. Locate the external PS/2 port at the rear of the notebook (refer to Figure 2-2).
3. Attach the PS/2 cable from your mouse and/or keyboard cable to the PS/2 port.
4. Power on any other peripheral devices you may have connected to the notebook, and then power up the notebook.

2.5.2 Installing External Parallel Printer

The Notebook is equipped with a bidirectional, ECC/EPP compatible, 25-pin parallel printer port. The connector pinouts and connector location are shown in Figure 2-3.

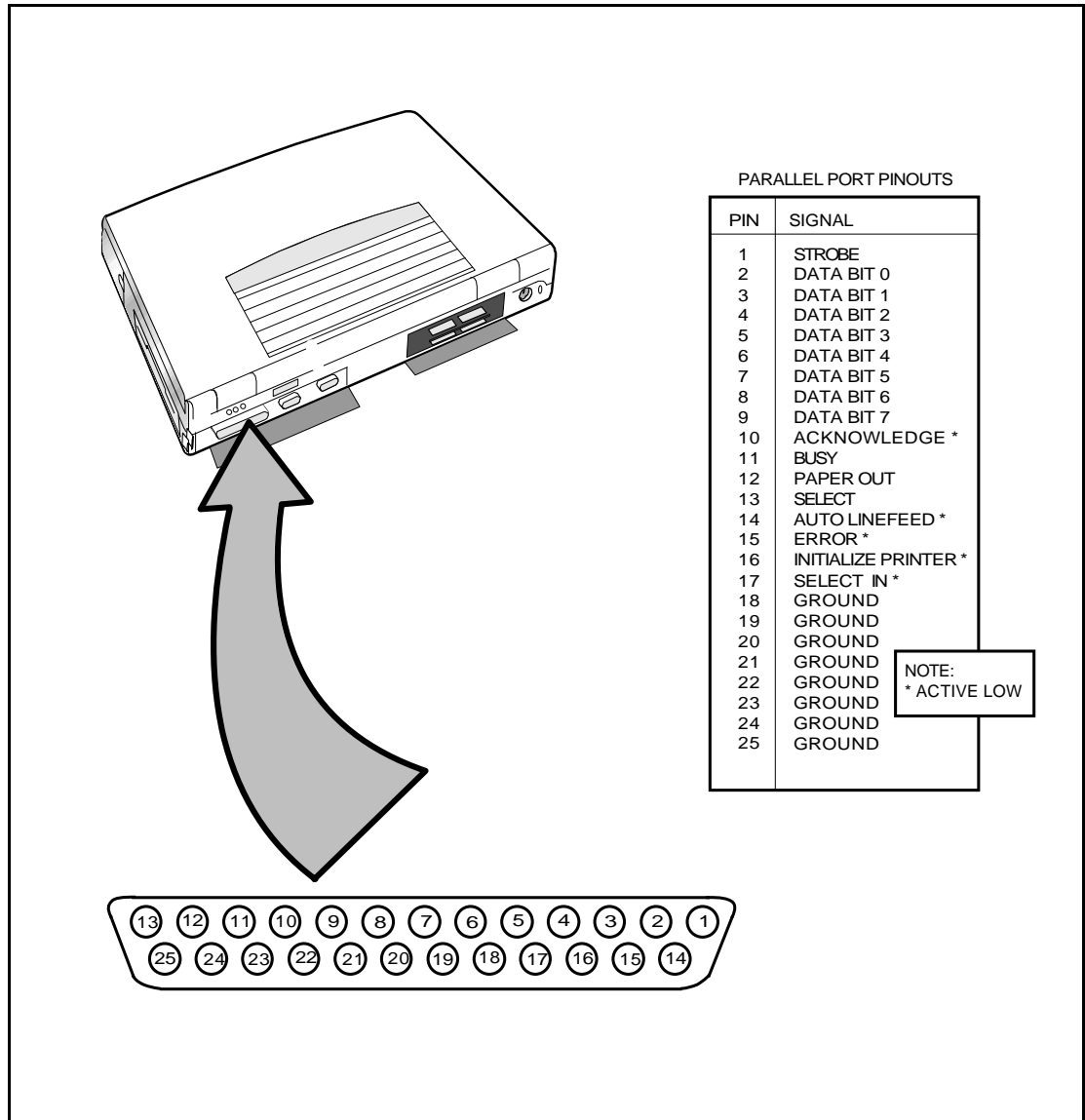

Figure 2-3 Parallel Port Location/Pinouts

2.5.3 Installing External Serial Port Device

The notebook contains an RS-232 serial port with a male DB-9 connector as shown in Figure 2-4. The serial ports are used to interconnect such devices as:

- External Modem
- Serial Printer
- Any device that uses an RS-232 interface

To connect a printer to the notebook, ensure that both the notebook and the printer are turned off.

C

Caution: Never connect a parallel device to a serial port or a serial device to a parallel port or video port; this may cause damage to the Notebook and/or peripheral device. If you are uncertain of what type connector the external device has, refer to the technical manual for the external device.

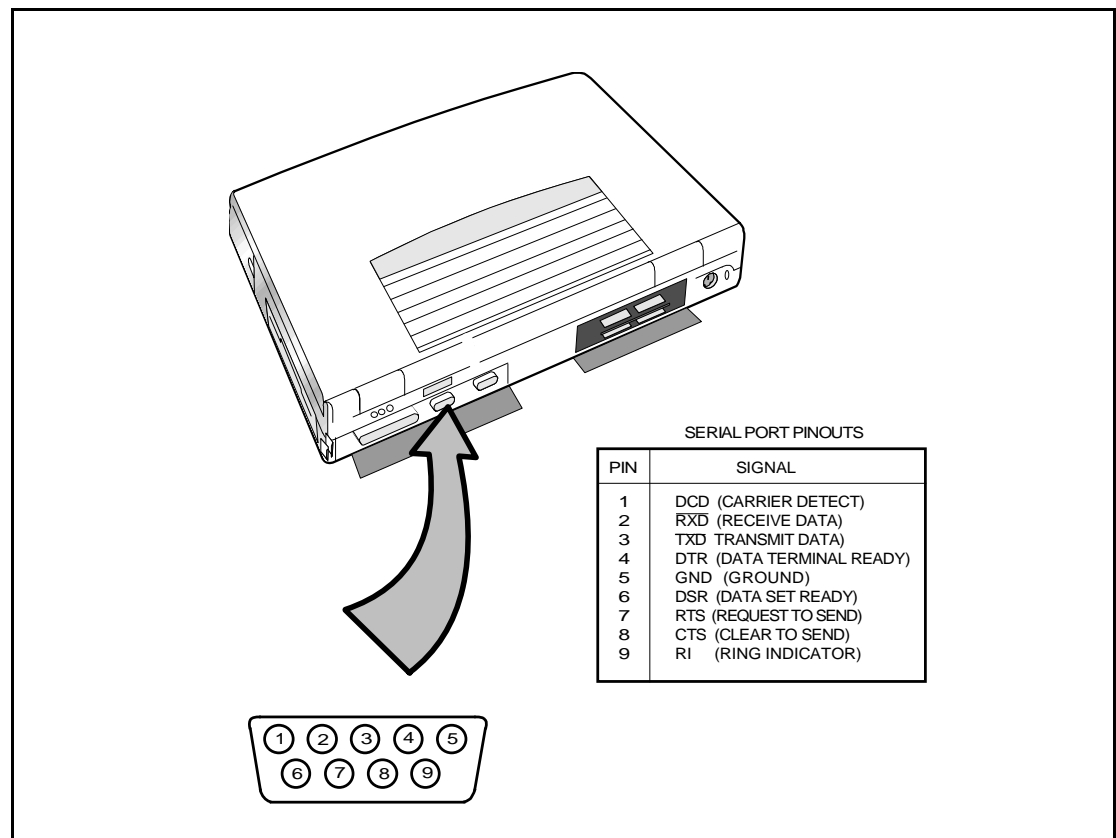

Figure 2-4 Serial Port Location/Pinouts

2.5.4 Installing External SVGA Monitor

The notebook is capable of driving both its internal LCD display and an external SVGA monitor (LCD only, simultaneous, or SVGA only). The external monitor connector pinouts and connector locations are shown in Figure 2-5. To install an external monitor with the notebook, use the following steps:

1. Ensure that both the notebook and the external monitor are turned off.
2. Locate the 15-pin female SVGA port on the Port Adapter.
3. Attach the appropriate end of the monitor cable to the SVGA port on your notebook. If the monitor cable connectors have retaining screws, tighten them down.
4. If necessary, connect the monitor power cable to the monitor, and plug the monitor power cable into an electrical outlet.
5. Power on the monitor, as well as any other peripheral devices connected to the notebook; then power up the notebook.

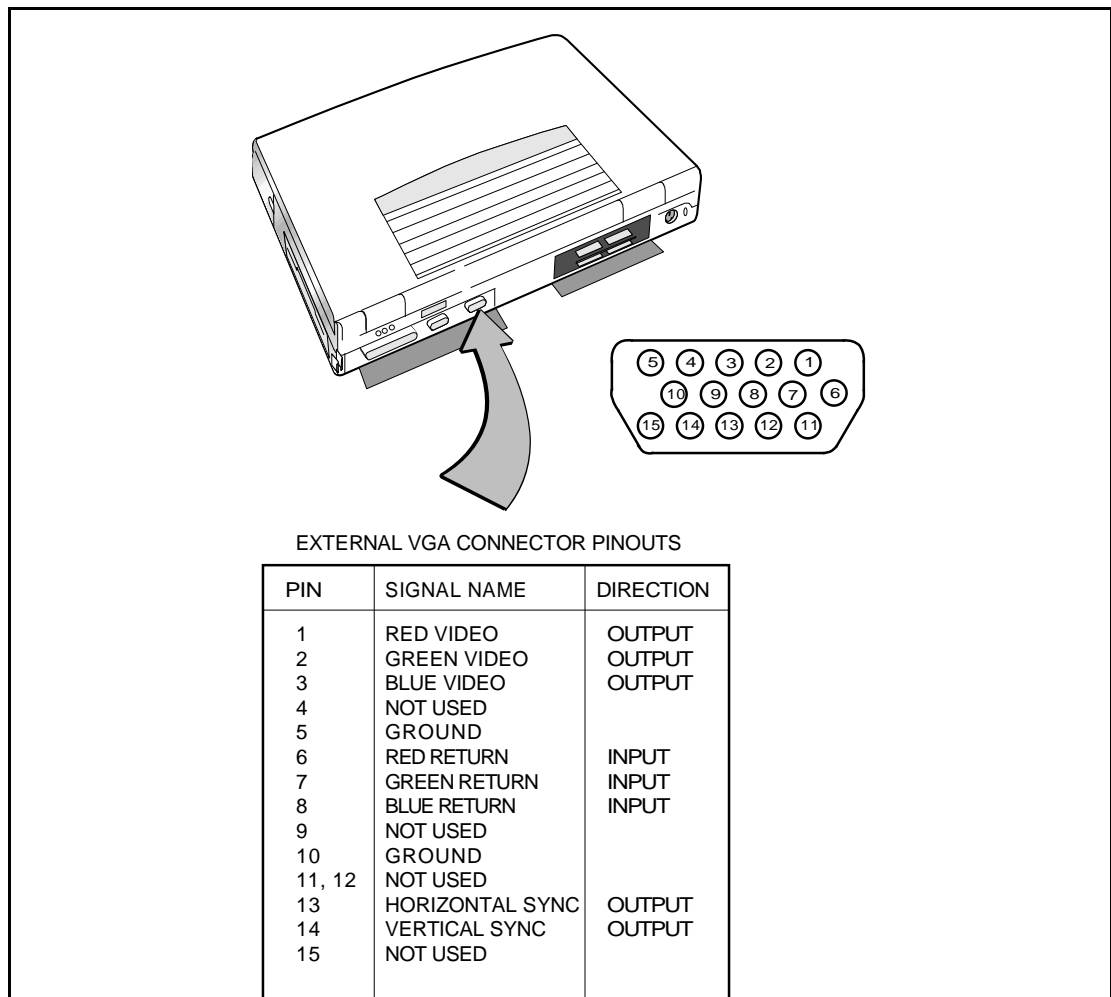

Figure 2-5 Connecting an External SVGA Monitor

2.5.5 Installing SIR Devices

The Serial Infrared (IR) port offers wireless communication with a variety of IRDA-compliant devices made by other manufacturers. Ensure that the third-party manufacturer supplies you with the appropriate IR drivers before attempting connection. As shown in Figure 2-6, the Notebook SIR port is located just above the serial port connector on the rear of the notebook. Align this port with the SIR port on a printer, notebook or other device equipped with an SIR port.

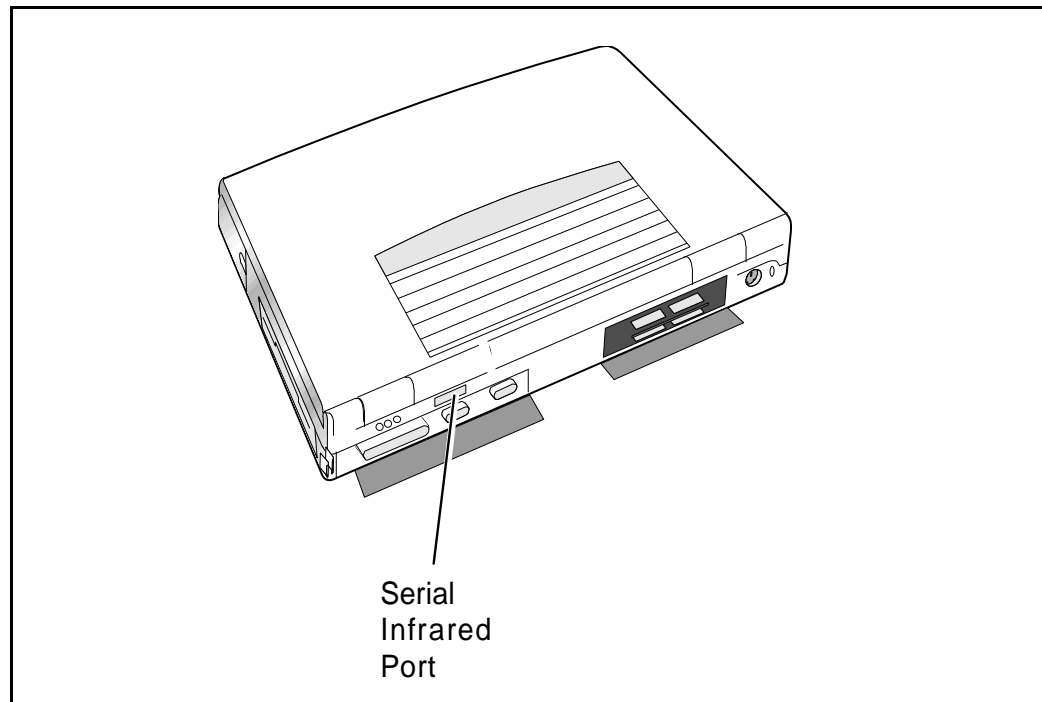

Figure 2-6 Communicating with SIR-Equipped Devices

2.6 Installing the AC Power Adapter

Use the following procedures to connect the AC Adapter to the system:

C

Caution: Use only the AC Adapter supplied with the computer; other adapters can damage the unit.

1. Remove the AC adapter from the packaging. Connect the round coaxial connector on the AC Adapter to the power receptacle on the left side (rear corner) of the notebook as shown in Figure 2-7.
2. Connect the female side of the AC Power cord to the AC Adapter and connect the male end to a grounded AC outlet.

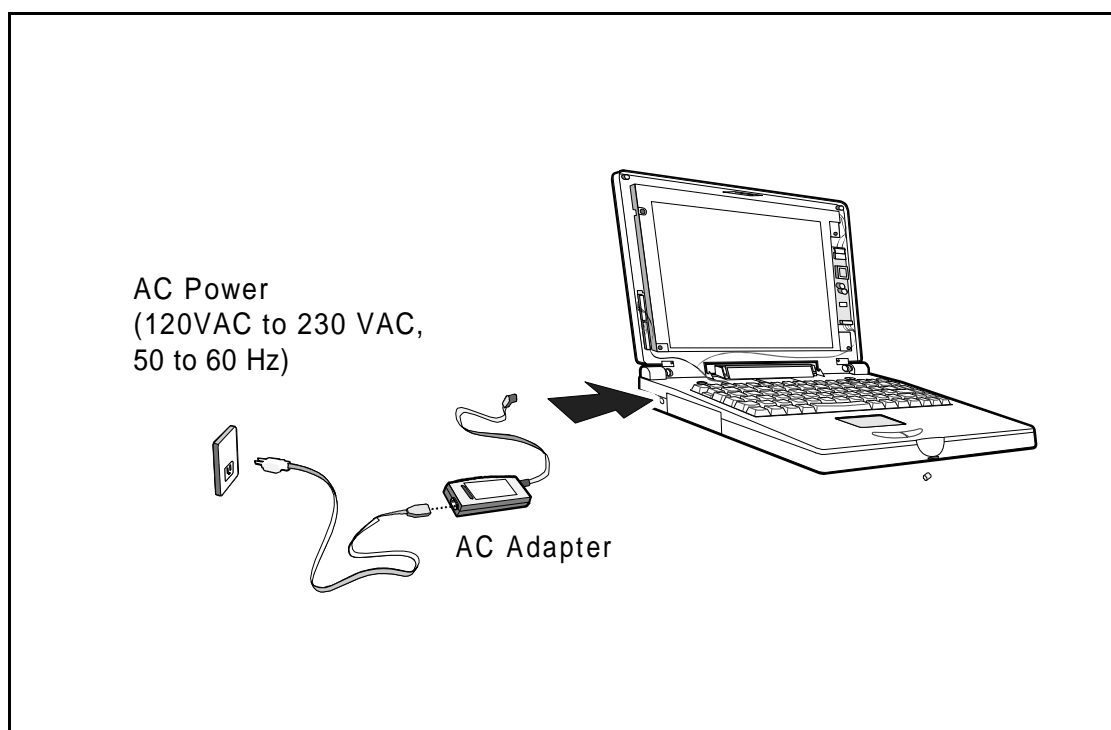

Figure 2-7 AC Adapter Installation

2.7 Initial System Checkout

After you've installed all internal options and external cabling, you're ready for system checkout and software configuration.

To check out the system, set the power switch on the notebook to the On position which initiates the notebook self test. During self test execution, the computer checks the operation of all critical hardware including memory and CPU (and displays copyright and version number data during test execution).

Upon successful conclusion of self test, the computer automatically loads its operating system and Windows environment. If self test fails to complete and an error message is displayed, try powering down the computer for a couple of minutes and turning power back on to repeat self test. If the error message persists, see Section 5 for troubleshooting information (also refer to Appendix A for self test error message descriptions).

2.8 Configuring the System

The first time you power up the notebook, it automatically runs the Setup Program which prompts you for country name and printer type. You exit Windows and the notebook begins unzipping files and preparing the software for use. After initial installation, and the timeout occurs, the demo may begin. To stop the demo, move the cursor to the center of the screen and click the left mouse button. A number of demo options are then available.

2.9 Making Backups of System Software

The Notebook is preloaded with Windows 95 operating system software. Prior to extended use of the notebook, create a backup set of system software using the Backup Utility under Windows 95. In the event of a disk problem, you can restore your system using the Restore Utility and the set of backup diskettes you've just created.

2.10 Loading Application Software

For assistance in loading Application Software, refer to Chapter 5 in the *Extensa Series Notebook Computer User's Reference Manual*.

Operating Instructions

3.1 Introduction

This section describes the Extensa 57x Series Notebook operating controls and indicators.

n

Note: For additional operating instructions, refer to the *Extensa 57x Series Notebook Computer Users Guide*.

3.2 Notebook Controls and Indicators

The Extensa Series Notebooks are equipped with the following controls and indicators:

- Alternate action Power Button in the upper left corner above the keyboard
- Status LCD centered above the keyboard - ICONs are used to convey status information (refer to Figure 3-1)
- Embedded special function keys in the keyboard (including Contrast and Brightness Control) are activated by the **Fn** key

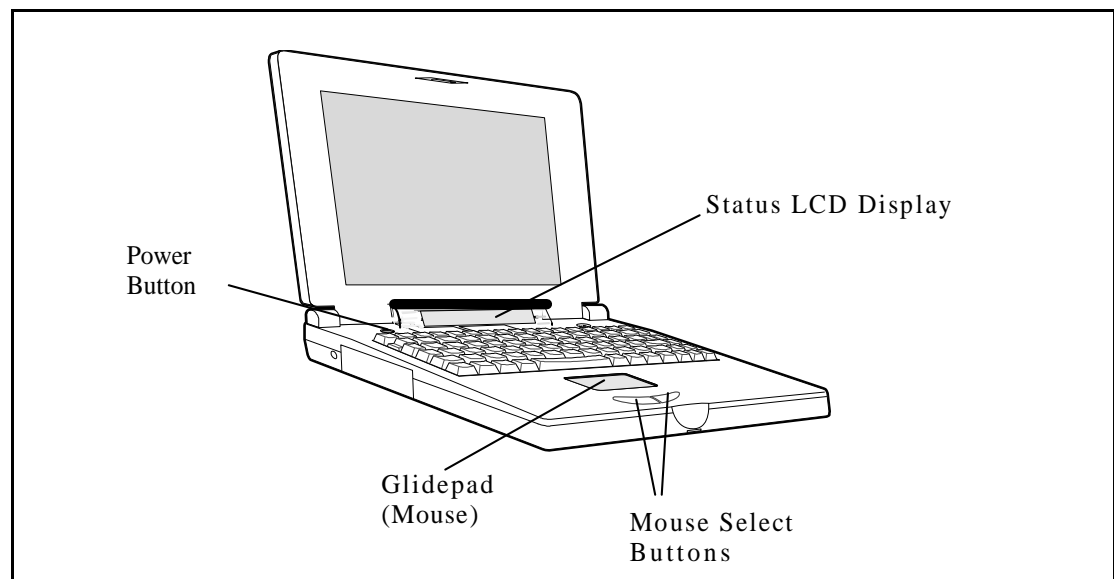

Figure 3-1 Extensa Series Controls and Indicators

3.2.1 LCD Contrast Control

The TFT version of the notebook contains no operating controls or indicators. Use the function keys to adjust the contrast and brightness. TFT versions are unaffected by contrast "key" adjustments.

3.2.2 Button Switches

The notebook contains one button switch above the keyboard: the **Power On/Off Switch**. This button is an alternate action type switch that controls power to the unit. Pressing the Power button causes power to be applied to the notebook, power up self test to be run and Windows 95 to be loaded. When the Power button is pressed again, the Notebook powers down and all data in RAM memory is lost.

3.2.3 Cover Release Latch

The Notebook contains a Cover Release latch near the center of the top cover. To open the notebook, lift up on the release mechanism along the front edge of the notebook.

3.2.4 Glidepad Controls

The Extensa 57x Series Notebook Computers are equipped with a built-in mouse device called the glidepad physically located at the base of the keyboard (refer to Figure 3-1).

The cursor is positioned by touching and dragging your finger in the direction you want the cursor to go. The select functions are performed either by tapping the glidepad or by pressing the two buttons (switches) at the bottom of the keyboard.

You can change the operation of the pad by changing values in the mouse section of the Windows 95 Control Panel. Once your cursor is in the proper place and you want to select, use the left button to click or double-click just as you would with a mouse.

3.3 Operating Procedures

Some of the operating features useful for notebook maintenance are provided in the following paragraphs. For additional operating instructions, refer to the *Extensa 57X Series Notebook Computer User's Manual*.

3.3.1 Floppy Drive Operating Procedures

To avoid damaging the floppy drive, and to protect data, take the following precautions:

- Never turn off or reset the notebook while the floppy activity indicator is lit.
- Keep the AC adapter at least 6 inches away from your drive.

-
- Insert the floppy into the floppy drive slot with the label side up and the metal-shutter end first. Gently push the floppy into the floppy drive slot until the floppy clicks into place.
 - To remove a floppy diskette, press the eject button until the floppy pops out.
 - Never force open the access shutter on a floppy.
 - Always remove a floppy from the floppy drive before turning off the computer.
 - Never transport the computer with a floppy in the floppy drive. Doing so can damage the drive head.
 - If a floppy appears to be damaged, try to make a copy of it, and immediately discard it.
 - Keep all floppies when not in use in a disk storage box to protect them from damage or loss.

3.3.2 Installing/Removing PCMCIA Options

PCMCIA cards are inserted and ejected in much the same way as diskettes:

- Up to two Type I or Type II PCMCIA options may be installed in the compartment on the right side of the notebook. One Type III Option may be installed in the lower slot.
- To insert a PCMCIA card, align the card with the socket and slide the card into the socket until it locks into place. To install a Type III option, you must remove the Floppy Drive.
- To eject a PCMCIA card, go to the Windows 95 Control Panel, select **PC Card** and select the card to stop; then press the release button and remove the PCMCIA option.

3.3.3 Computer Hot Keys

- Refer to the User's Guide shipped with the notebook for a description of the recognized hot keys.

3.3.4 Responding to Low Battery Conditions

The computer generally will notify you when you are reaching a low battery condition by performing the following actions:

- One beep every 10 seconds (unless battery warning is disabled)
- The battery low warning is automatically disabled when the AC Adapter is installed on the notebook regardless of the charge condition of the battery pack.
- If the AC adapter is not plugged in within three minutes of a detected battery low condition, the notebook enters Standby mode.
- The Notebook returns to the normal operating mode when the power switch is activated. Unit then recovers RAM information from the hard drive and restores unit to previous "On" condition.

3.3.5 Minimizing Power Usage

The following actions can minimize power usage and protect your work during the critical minutes before you shut the system down or replace one of the battery packs with a fully charged pack:

- Press **Ctrl-Standby** to shut off the alarm (if it's enabled)
- Save RAM Disk (if using RAM Disk feature)
- Power down the system if you do not need the computer

3.3.6 Recharging the Battery Packs

A standalone battery charger option is available to charge notebook battery packs. The battery packs may also be charged in the notebook as follows:

1. Install the battery pack(s) in your computer (if not already installed).
2. Connect the AC Adapter as described in Section 2.
3. To fully charge the battery pack, leave it charging in the Notebook for at least another 90 minutes.
4. Periodically recondition the primary battery (Nickel Metal Hydride) as described in Paragraph 3.3.7.

3.3.7 Conditioning the Primary Battery

The primary battery pack is a Nickel-Metal Hydride type that requires periodic deep discharge and recharge in order to accept a full charge (approximately every 5 or 6 charge/recharge cycles). To condition the main battery, use the following procedure:

1. Remove the secondary battery (if installed in the Floppy Drive bay) and AC Adapter (if installed).
2. Power up the computer and leave it on until the primary battery is completely discharged; then reconnect the AC adapter and fully charge the battery. Reinstall the secondary battery in the Floppy Bay (if using a secondary battery pack).

3.3.8 Restoring Missing System Files

When you power up the Notebook, it automatically checks for certain key files that must be present for normal system operation. If any of these files are accidentally erased, as indicated by error message, insert the *Windows95 Startup diskette* and reboot the system. This will allow you to boot up and troubleshoot your system.

3.3.9 Rebuilding the System Software

In the event of a hard drive replacement or system board replacement which resulted in loss of system software, you may need to rebuild the entire system software structure.

The following items are required to rebuild the system software:

- Set of backup diskettes of the system software
- Operational Notebook

Insert the *Windows 95 Startup* diskette in the Notebook's floppy drive and power up the system.

n

Note: For additional operating procedures, refer to to the *Extensa 500 Series Notebook Computer User's Manual*, Texas Instruments Part No. 9803942-0001.

Theory of Operation

4.1 Introduction

This section describes the notebook theory of operation.

4.2 Notebook Functional Description

Functionally, the notebook computer consists of the following major subsystems:

- Processor and Memory Subsystem
- I/O Subsystem
- Video Subsystem
- Hard Disk Subsystem
- Floppy Disk Subsystem
- CD-ROM Subsystem
- PCMCIA Subsystem
- Sound Subsystem
- Serial Infrared Subsystem
- Power Subsystem

A functional block diagram of the Extensa 57x Series Notebook is shown in Figure 4-1.

4.2.1 Processor/Memory Subsystems

The Processor function, housed on the Main Board, is implemented with the Intel™ Pentium Processor (P54C/LM). The processor operates in conjunction with RAM and ROM Memory on the Memory Board and other control logic on the Main Board to process software instructions (BIOS, Windows 95, and Applications).

Primary control for the Processor/Memory subsystem is implemented with the Pentium Chipset (Opti Viper 82C556/82C557).

The memory subsystem, implemented on the Memory Board and optional Dual Inline Memory Modules, provides 8 MB (expandable to 40 MB) of fast

DRAM memory, 128 bytes of CMOS RAM (battery backed up) and 256 KB of Flash ROM for system and video BIOS storage.

The basic 8 MB memory system can be expanded to a maximum of 40 MB by the addition of two DIMM memory modules (refer to Section 6 for installation details).

Tables 4-1 through 4-3 contain the Notebook I/O address map, DMA channel assignments and IRQ interrupt level assignments respectively.

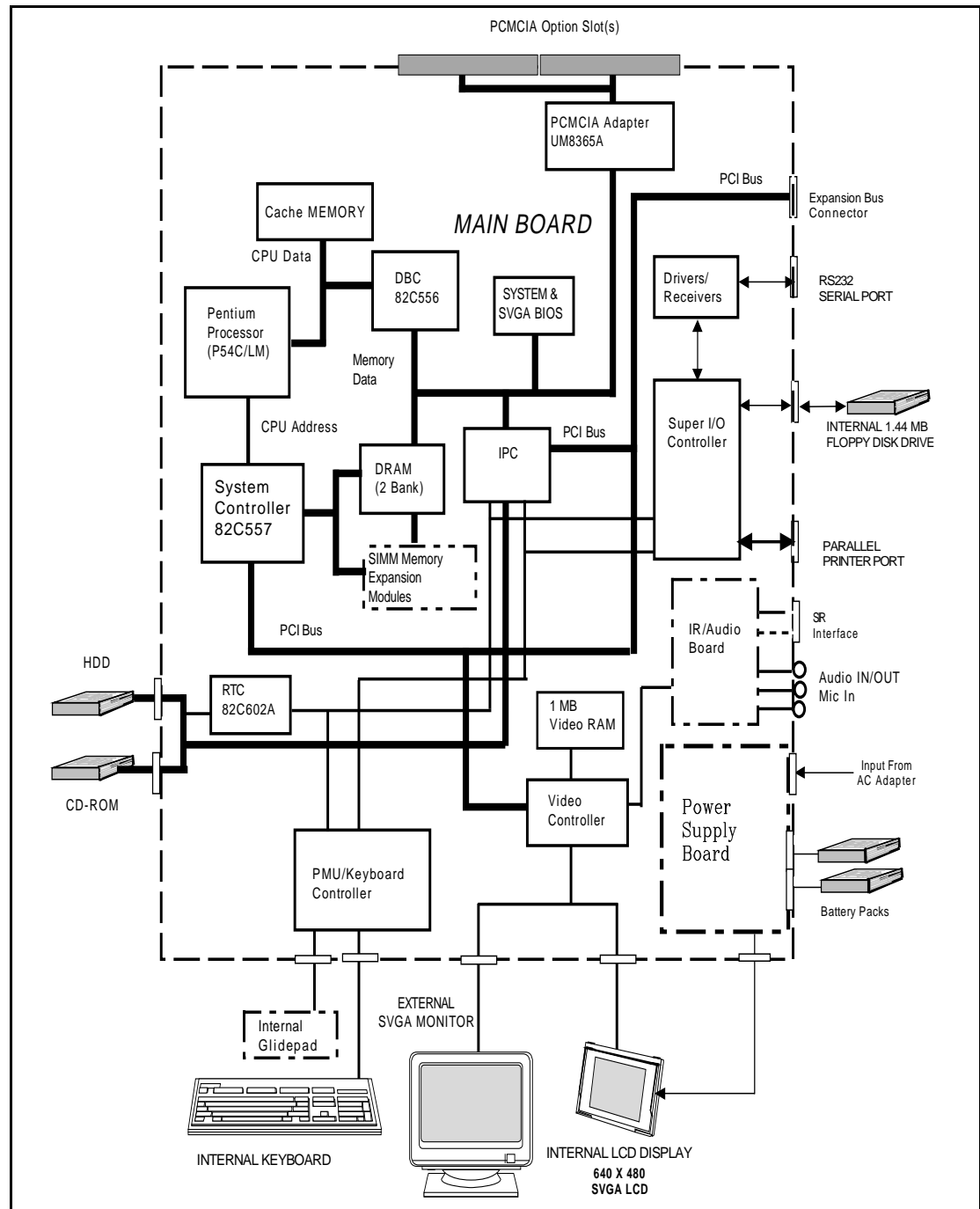

Figure 4-1 Notebook Functional Block Diagram

Table 4-1 Extensa Series I/O Address Map

Address Range	Device
000-00F	DMA Controller 1
020-021	Interrupt Controller 1
022-023	M1429 Registers
040-043	Timer 1
060-06E	Keyboard Controller 8742 Chip Select
070-071	Real Time Clock and NMI Mask
080-08F	DMA Page Register
0A0-0A1	Interrupt Controller 2
0C0-0DF	DMA Controller 2
1F0-1F7	Hard Disk Select
178, 17A	6377 Registers
1F0-1F7	Hard Disk Select
3F6, 3F7	
278-27F	Parallel Port 3
35F, 36F	Special I/O Ports
378, 37A	Parallel Port 2
3BC-3BE	Parallel Port 1
3C0-3C5	
3C6-3C9	Video DAC
3C0-3CF	Enhanced Graphics Display
3D0-3DF	Color Graphics Adapter
3E0-3E1	PCMCIA Controller
3F0-3F7	Floppy Disk Controller
3F8-3FF	Serial Port 1

Table 4-2 DMA Channels

Controller	Channel	Address	Function
1	0	0087	Spare
1	1	0083	Spare
1	2	0081	Diskette
1	3	0082	Spare
2	4	Cascade	Cascade
2	5	008B	Spare
2	6	0089	Spare
2	7	008A	Spare

Table 4-3 IRQ Interrupt Levels

Priority	Interrupt Number	Interrupt Source
1	SMI	Power management unit
2	NMI	Parity Error Detected, I/O Channel Error
3	IRQ0	Interval Timer, Counter 0 Output
4	IRQ1	Keyboard
	IRQ 2	Interrupt from controller 2 (cascade)
5	IRQ8	Real Time Clock
6	IRQ 9	Cascaded to INT 0AH (IRQ 2)
7	IRQ10	Reserved
8	IRQ 11	Reserved
9	IRQ 12	PS/2 Mouse
10	IRQ13	INT from Coprocessor
11	IRQ14	Hard Disk Controller
12	IRQ15	Reserved
13	IRQ3	Serial Comm Port 2
14	IRQ4	Serial Comm Port 1
15	IRQ5	Reserved
16	IRQ6	Diskette Controller

Priority	Interrupt Number	Interrupt Source
17	IRQ7	Parallel Port

n

Note: A PCMCIA card can use IRQ 3, 4, 5, 7, 9 and 11 as long as it does not conflict with the interrupt address of any other device.

4.2.2 I/O Subsystem

The I/O subsystem, implemented with an SMC37C655IR Super I/O Controller Chip, provides for such functions as internal floppy drive control, serial and parallel ports and support for the Serial Infrared port. The Super I/O Controller includes the following features:

- 100 percent compatible with ISA, EISA, and micro-channel architectures
- Built-in floppy disk controller
- Two UARTs
 - Software compatible with the PC16550A and PC16450
 - MIDI compatible
 - Infrared support on UART2 (IRDA-compliant)
- Bidirectional Parallel Port
 - Enhanced Parallel Port (EPP) compatible
 - Extended Capabilities Port (ECP) compatible, including level 2 support
 - Bidirectional under either software or hardware control
 - Compatible with ISA, EISA, and Micro Channel architectures
 - Ability to multiplex FDC signals on parallel port pins for external FDD
 - Includes protection circuit against damage caused when printer is powered up, or operated at higher voltages
- Integral address decoder- provides selection of all primary and secondary ISA addresses including COM1-4 and LPT1-3.
- Enhanced Power Management Function
 - Enhanced programmable power-down and wake-up modes

-
- Auto power-down and wake-up modes
 - Typical current consumption during power-down is less than 10A

4.2.3 Video Subsystem

The video subsystem, implemented on the Main Board and on the LCD Display Unit, displays text, graphics and drives an external SVGA port. The video subsystem is implemented with a Cirrus™ Logic CL-GD 7543 high performance VGA controller and supporting logic and video RAM (1 MB).

The major features of the VGA controller include:

- Highly integrated design (flat panel / CRT VGA controller, RAMDAC, clock synthesizer)
- Multiple Bus Architecture Integrated Interface
 - Local Bus (32-bit CPU Direct and VL)
 - EISA/ISA (PC/AT™) 16-bit Bus
- Integrated programmable linear address feature accelerates GUI performance
- Supports panel resolutions up to 1280 X 1024 resolution including 800 X 600 and 1024 X 768
- SMARTMAP intelligent color to gray scale conversion enhances text legibility
- Text enhancement feature improves white text contrast on flat panel displays
- Fully Compatible with IBM SVGA

4.2.3.1 External SVGA Drive Capability

The Extensa 57X contains an external SVGA port (15-pin, female, D-type connector) which can be used to drive an external CRT (standard SVGA modes with resolutions of 800 X 600 X 256, or 640 X 480 X 256).

4.2.4 Hard Disk Subsystem

The Hard Disk Subsystem, controlled by the IDE interface compatible 82C558N IPC chip, provides disk storage for all system software and user files. Initially, the 57X Series Notebooks are equipped with a removable 810 or 1200 Million Byte hard drive.

During the manufacturing process, Texas Instruments formats the hard disk and then loads all supplied software including Windows 95.

C

Caution: Formatting the disk drive erases any data that may be stored on the disk. Therefore do not attempt a format of the hard disk unless the computer self test and diagnostics confirm that the disk has not been formatted.

A Hard Drive activity ICON is located on the Status LED beneath the Display Assembly. This ICON is visible during hard driver read/write accesses.

C

Caution: The notebook should not be moved when the HDD ICON is lit to prevent accidental damage to the hard drive.

4.2.5 Floppy Diskette Drive Subsystem

The Floppy Diskette Drive Subsystem consists of a Floppy Controller (part of the Super I/O Chip, SMC37C655IR) and the removable Floppy Diskette Drive. The Floppy Diskette Drive can read/write standard 3.5-inch minidiskettes. The floppy drive installs in the Media Bay and can be removed to install a CD-ROM drive or a second battery pack (Lithium Ion).

4.2.6 CD-ROM Subsystem

Many of the Extensa 57x models are equipped with a removable 5.25 inch, CD-ROM drive (4X or 6X speeds). The drive uses the standard ATAPI interface.

The CD-ROM subsystem is controlled by the IPC (which also controls the hard drive subsystem).

4.2.7 PCMCIA Subsystem

The notebook is equipped with an on-board PCMCIA host adapter (UM8366F) PCMCIA Controller) and sockets to support Type I, II, or III options. The PCMCIA Controller has the following features:

- Single-chip PCMCIA host adapters
- Direct connection to ISA (PC AT) Bus
- Direct connection to PCMCIA 2.0 Bus
- PCMCIA 2.0- and JEIDA 4.1-compliant
- 82365SL-compatible register set, ExCA-compatible
- Automatic Low-power Dynamic Mode for lowest power consumption
- Programmable Suspend Mode
- Five programmable memory windows per socket

-
- Two I/O windows per socket
 - Programmable card access cycle timing
 - 8- or 16-bit CPU interface
 - 8- or 16-bit PCMCIA interface support
 - ATA disk interface support
 - Automatic flash memory timing support
 - Easy host interface using ISA I/O addresses 03E0h, 03E1h
 - Mixed-voltage (3.3V or 5V) operation
 - Dual-socket-interface, 208-pin QFP

4.2.8 Sound Subsystem (Model Dependent)

Some models of the Extensa 57x Series notebooks are equipped with a 16-bit stereo sound system including:

- Built-in microphone and stereo speakers
- Stereo line input (5-pin jack, DIP)
- Stereo Line Output (5-pin jack, DIP)
- External microphone input (5-pin jack, DIP)
- Audio chipset

The sound subsystem is physically implemented on the IR/Sound Board.

4.2.9 Power Subsystem

The Power Subsystem consists of the following major parts:

- Power Management (hardware and software components)
- AC Adapter
- Power Supply Board
- Nickel Metal Hydride (NiMH) Battery Pack
- Optional Secondary Battery Pack (Lithium Ion) if not using the Media Bay for a floppy drive or CD-ROM Drive

4.2.9.1 Power Management

The notebook is equipped with a power management function that minimizes battery usage for prolonged battery operation and automatically recharges the batteries when the notebook is used with an AC adapter.

The power management modes and warnings include the following:

- LCD standby mode
- Hard disk/CD-ROM standby mode
- System standby/suspend mode
- Battery-low warning
- Standby/suspend upon battery low

4.2.9.2 AC Adapter

The notebook uses an AC adapter with built in over voltage and short circuit protection.

The adapter can with stand a continuous short-circuit to DC output without damage to the notebook logic components and resets to the normal power mode after the fault condition is removed.

4.2.9.3 Primary Battery Pack

The Extensa 57x Series Notebooks use a Nickel Metal Hydride battery as the primary battery pack. Specifications for the primary battery pack are provided in Table 4-4.

Table 4-4 Primary Battery Pack Specifications

Function	Specifications
Battery type	NiMH (Nickel Metal-Hydride)
Cell Type	A
Nominal voltage	8.4 V
Cell energy capacity	4200 mAH
Nominal rated capacity	27 Watt-hours
Charge and discharge cycles	500 (minimum)

4.2.9.4 DC-DC Converter/Battery Charger Circuit

The power supply board includes two DC-DC Converter circuits and a battery charging circuit that operate the notebook and charge the internal batteries when the AC Adapter is attached to the notebook. The converters operate from an input voltage between 7 VDC and 20 VDC (from the AC adapter) and generate the regulated voltages required to power all internal logic circuits and charge the internal batteries. When the AC adapter is not used, the DC-DC converters are powered by the output of the internal battery pack (s) (nominal 8.4V).

Troubleshooting Procedures

5.1 General

This section provides the following information:

- Overview of the fault isolation process
- Guidelines for isolating computer malfunctions to replaceable subassemblies
- Instructions for executing diagnostics and interpreting error messages.

5.2 Overview of Fault Isolation Process

The fault isolation process (summarized in Figure 5-1) consists of the following:

- Quick Check of the following:
 - Notebook power system (including battery packs and AC Adapter connections)- refer to Paragraph 5.4.
 - Switch settings (ensure **Power** switch is On, and press **Standby** switch to ensure that Notebook is not in Standby mode; press **Shift** to ensure the notebook is not in Auto-Suspend mode.
 - All external cabling (if any).
 - Check LCD Contrast adjustment (Dual Scan version only).
- Record and attempt to resolve any displayed error messages/LED indications (refer to Paragraph 5.3 and Table 5-1).
- Record and attempt to resolve any series of beeps emitted from the notebook indicating test failure (refer to Table 5-2).

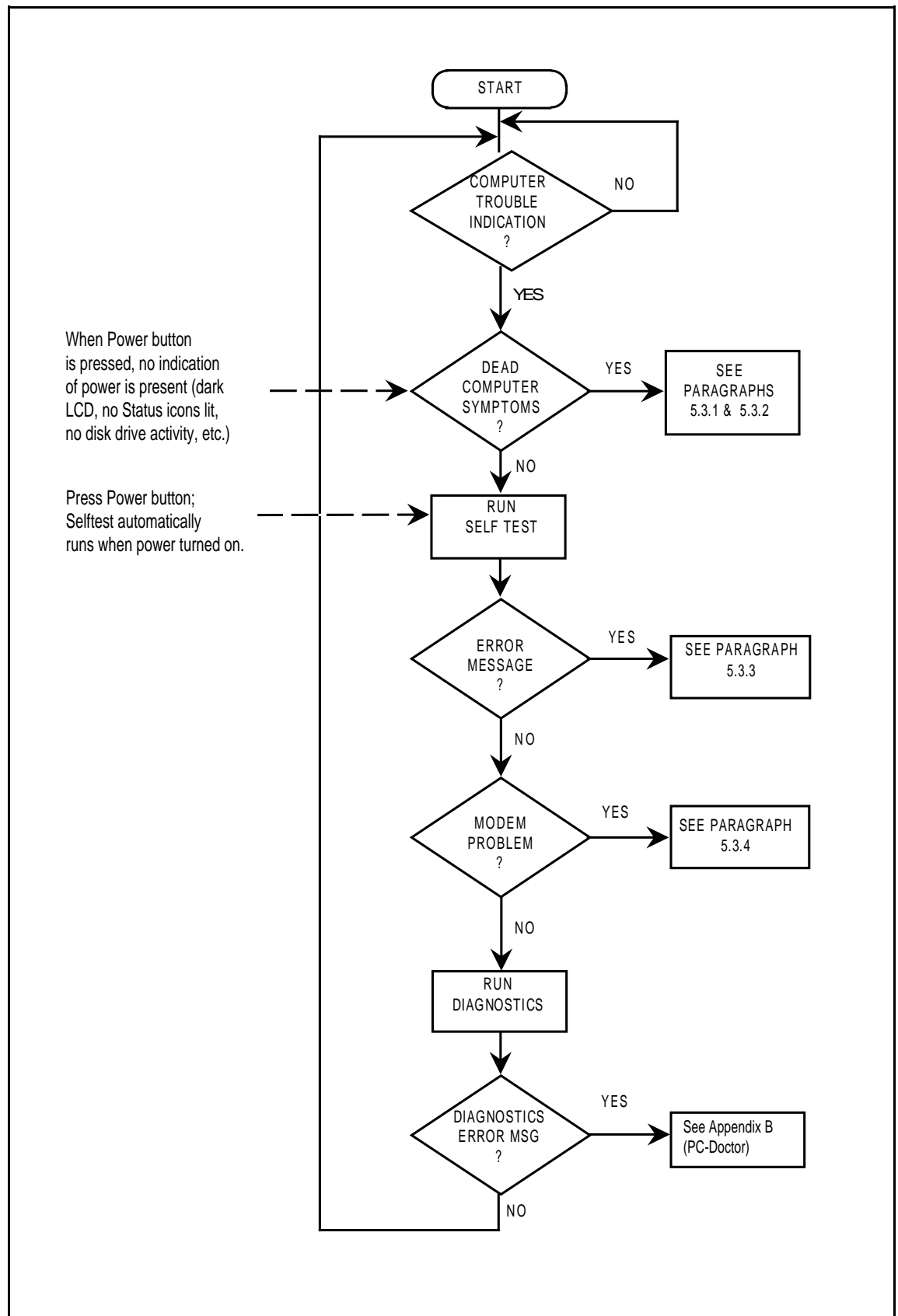

Figure 5-1 Troubleshooting Flowchart

-
- Try rebooting the system (**Ctrl-Alt-Del**); restore system from diskettes, if necessary.
 - If the computer is capable of running the Setup program; check the serial and parallel port configurations, and other features that may affect system operation.
 - Run Diagnostics to further isolate problem area (refer to Paragraph 5.3.5).
 - For indicated hardware failures, cycle power and repeat self test to verify that a hard failure has occurred.
 - Remove and replace suspect hardware (as described in Section 6 of this manual) and retest the system using the diagnostic tests as described in Paragraph 5.3.5.

The detailed block diagram, shown in Figure 5-2, is useful in performing fault analysis of various internal subsystems. For example, an LCD hardware problem can be traced to either the LCD, Inverter Board, or Power Supply Board. Other subsystem problems can be isolated in a similar fashion using the detailed block diagram as a troubleshooting tool.

5.3 Troubleshooting Procedures

The built-in self test program and the disk resident diagnostics program (PC-Doctor) are useful tools in computer troubleshooting. However, if the computer has a power, keyboard or display problem, you first solve this problem before running diagnostics. If the computer powers up and displays messages on the LCD or emits a series of beeps, skip to Paragraph 5.3.3 for further instructions.

5.3.1 Troubleshooting a Power Supply Problem

If the computer does not power up when the Power Switch is set to the ON position, you most likely have a malfunction in the power subsystem (loss of power at the AC Outlet, faulty AC Adapter, discharged Battery Pack, or faulty Power Supply Board). With a power problem, the status screen and the LCD are both blank, and no drive activity can be heard. The computer is unable to load software and displays no visible signs of activity.

To fault isolate a power problem, check the following:

- AC Adapter and Battery- Plug in the AC adapter and double check all connections on the adapter and computer. Ensure that the notebook **Power** button is set to the On position and that the system is not in standby or sleep modes.
- Measure the voltage at the AC outlet or plug in a known good appliance (e.g. a lamp) to verify that voltage is present. If the voltage is okay, try replacing the AC adapter.

- Check to see that the battery pack is installed correctly (try using a recharged battery pack if battery is discharged)
- If the AC outlet voltage, AC Adapter, and battery packs test normal but the computer will not power up, replace the Power Supply Board and/or Battery Board as described in Section 6.

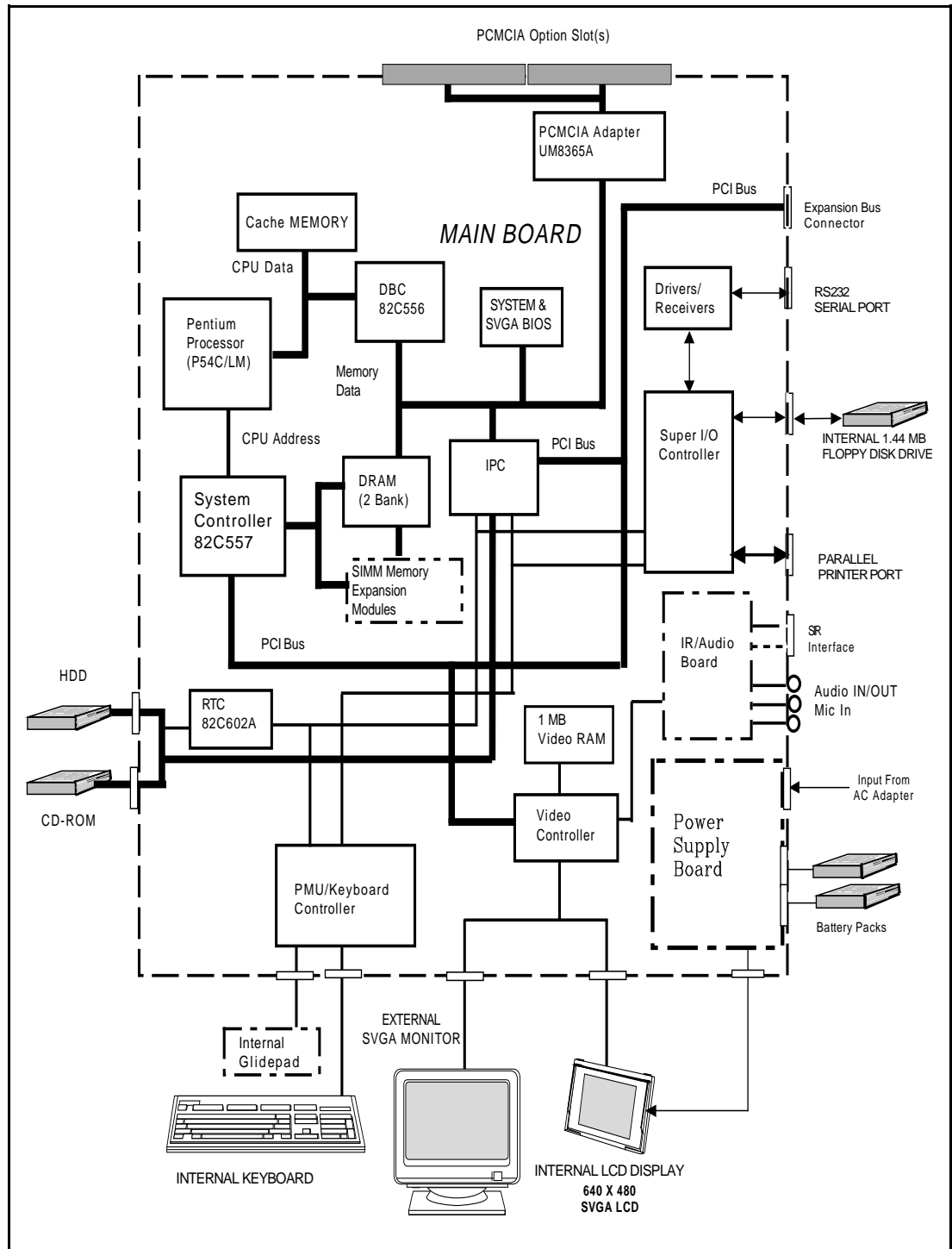

Figure 5-2 Troubleshooting Block Diagram

5.3.2 Troubleshooting a Display Problem

If the LCD remains blank when you turn on the computer, and the status ICONs light on the Status display panel above the keyboard, check the following controls on the display:

- LCD standby mode - If the LCD backlight remains off, even with the Contrast Control set to its highest position, the LCD may be in **Standby Mode**. Press the **Power** button to power up the system.
- Notebook Set for External Monitor - use CMOS Setup to reset notebook.
- LCD - Replace the cover-display assembly as described in Section 6 of this manual.
- Low battery - Use a fully charged battery.

5.3.3 Fault Isolation Using Self Test

When the computer is first powered up, it automatically performs a self test of its central hardware and memory functions. During self test (which lasts for a few seconds), the display shows copyright and version number information.

n

Note: Some procedures in this paragraph require you to use keystroke sequences, such as **Ctrl-Alt-Del**. To execute a keystroke sequence such as this, you must press all three keys simultaneously.

5.3.3.1 Self Test Error Messages

Upon successful completion of the self test, the computer automatically loads its operating system and other built-in utilities. If the self test fails to complete successfully, the display shows one of the error messages described in Appendix A.

5.3.4 PCMCIA Modem Problems

If an optional PCMCIA modem does not work properly, check the following items:

- Proper installation of any PCMCIA options (check Modem settings under Control Panel).
- Dialing problem or wrong number - Try dialing a number that you have previously dialed successfully.

- Faulty phone line - Connect a telephone to the line and listen for a dial tone.
- Software program - Check to ensure that you have installed the software correctly.
- I/O Address Conflict - The multimedia sound capability of the Extensa uses I/O address 220. However, this may conflict with some third-party PCMCIA cards like the IBM Token Ring card. In this case, reset the Extensa multimedia sound to I/O address 240 as shown in Figure 5-3.

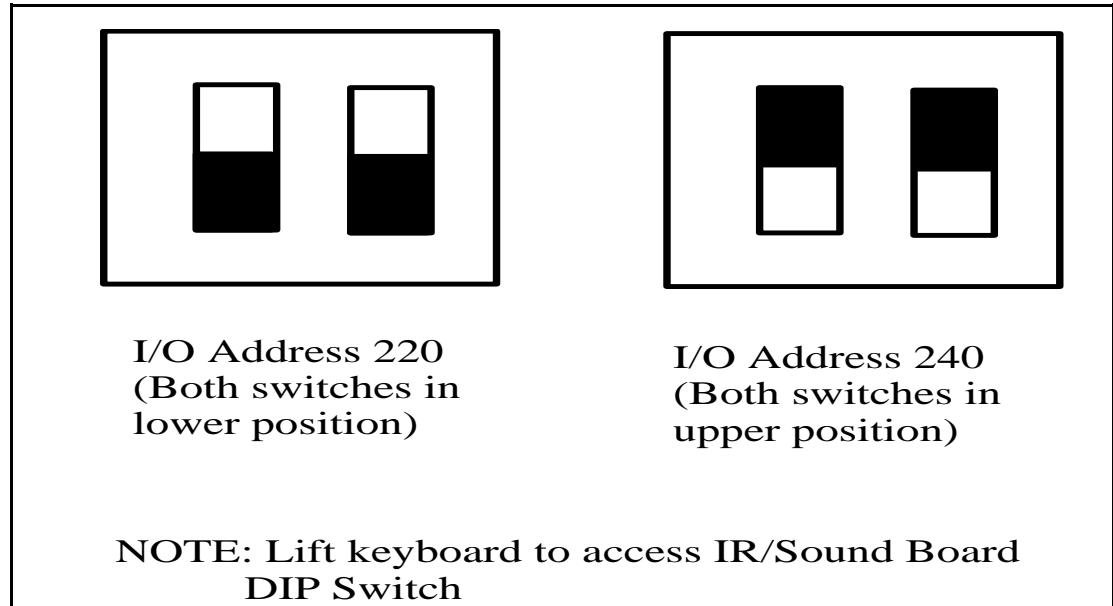

Figure 5-3 I/O Address Setting (IR/Sound Board)

5.3.5 Fault Isolation Using Diagnostics

PC-Doctor supplied with the Extensa Series Notebooks is a powerful diagnostics tool that can help you scan an internal RAM system for viruses, determine the hardware configuration of a local or remote system, benchmark its performance, analyze the performance of all subsystems, and perform a suite of interactive and non-interactive tests on attached devices. The test results are stored in a log which can be printed out (by pressing **F2**) or saved in a disk file (by pressing **F3**).

Features of the diagnostic program are accessed through a series of pull-down menus and basic keyboard keys (cursor keys to move highlighted pointer, Enter key to select a highlighted feature, Esc key to cancel a function and move back one level. PC-Doctor is typically user friendly but if you don't understand a feature, context-sensitive help information is available at any time by pressing the **F1** function key; pressing the **F1** function key twice accesses the online *Technical Reference Manual for PC-Doctor*.

A powerful set of utilities within PC-Doctor (that can be run locally or remotely) simplify the task of determining system configuration data,

allocating and using system memory, IRQ and DMA use, what device drivers are installed, what COM and LPT ports are assigned and what ports are available, identifying partitioning data for fixed disk drive(s), determining the SVGA setup information, reading the software interrupts/interrupt vectors, etc.

Functionally, PC-Doctor includes the following:

- Group of nine non-interactive diagnostic tests that perform a non-destructive test of the major hardware functions in the notebook (Processor, Memory, System board, video section, serial and parallel ports (when loopback adapters are installed), hard disk and floppy disk.
- Group of seven interactive tests (require operator input) for testing the keyboard, video sections, sound subsystem, mouse, joystick, diskette drive, printer subsystem and SCSI/CD-ROM Drive subsystems.
- Utility that provides detailed system information such as configuration data, allocation and use of system memory, IRQ and DMA use, what device drivers are installed, what COM and LPT ports are assigned and what ports are available, partitioning data for fixed disk drive(s), SVGA setup information, software interrupts and interrupt vectors.
- Group of special purpose utilities to run other tests from PC-Doctor, perform a virus scan of the internal RAM system, edit configuration files, surface scan hard drives, measure system performance, open a DOS prompt, provides terminal access to devices connected to serial ports, supports memory debug operations, enables remote operations, permits deep discharge of notebook batteries and provides an extensive test reporting function.

The PC-Doctor diagnostic program contains a group of nine non-Interactive diagnostics, available from the **Diagnostics** heading in the main menu, that permits testing various hardware sections without operator input. You can select one, several, or all tests from the Diagnostics menu. These tests are non-destructive; the serial and parallel port tests require disconnecting external devices from your notebook and installing loopback plugs. The Non-Interactive test categories include:

- CPU and Coprocessor tests
- Base RAM memory test
- System Board test
- Video Test
- COM1 and LPT1 serial port tests
- Parallel Port Test
- Fixed Disk test
- Diskette Drive tests

-
- Other devices (Sound card, PCMCIA options, etc.)

Interactive Tests

The PC-Doctor diagnostic test includes a suite of seven Interactive tests that require operator input during the course of the test. The **Interactive Tests** category includes:

- **Keyboard** - tests the keyboard keys, LEDs and repeat function
- **Video** - tests the LCD and external SVGA character sets, and colors.
- **Speaker**- tests the volume response at different frequencies.
- **Mouse** - tests the mouse driver, buttons and functionality
- **Joystick** - calibrates the external joystick connected to the system and tests the joystick buttons
- **Diskette Drive** - checks diskette drive functionality
- **Maximum System Load** - thoroughly exercises system to the maximum extent possible for performing system burn-in and test
- **Printer Test** - tests the operation of a connected printer
- **SCSI Test** - sends test codes to attached SCSI devices (requires use of a Docking System with SCSI)
- **CD-ROM Test** - checks out any attached CD-ROM Drive (requires attachment of a Docking System with CD-ROM capability)

Supporting Online documentation

The PC-Doctor Diagnostic contains the following online information sources:

- Online Technical Manual - selected at any time by pressing **F1** key twice or by clicking on the Question Mark in the upper left hand corner of any PC-Doctor Menu
- On-line Help system that provides context sensitive information from every PC-Doctor screen - accessed by pressing **F1** key once (pressing **F1** twice gets you into the online manual)

5.3.5.1 User Interface to PC-Doctor

PC-Doctor is structured as a text mode, window user interface with pull-down menus. Program operation requires the use of the following keys:

- Cursor Keys - move the highlighted pointer
- Enter Key - Selects the highlighted option
- Esc Key - Cancels current function and goes back one step
- F1 Key - Activates the context-sensitive help feature (pressing **F1** twice in a row calls up the online *Technical Reference Manual for PC-Doctor*)

Scrolling windows, which show the results of various operations, use the following keys:

- Page Up/Page Down - moves the screen one page at a time
- F2 - Prints the log to PRN
- F3 - saves the log to a file

You can also use the mouse or glidepad to interact with PC-Doctor. The leftmost **Select** key is used to choose objects (menu entries and action codes typically enclosed in brackets). The rightmost **Select** key is equivalent to the **Esc** key which takes you back to your previous step.

5.3.5.2 Creating a Bootable Floppy Diskette

Prior to using PC-Doctor, create a bootable floppy diskette using the following procedure:

1. Power up the unit; when unit displays message, "Starting Windows 95", press **F8**. Choose **Command Prompt Only** from menu.
2. Using DOS, format a floppy diskette.
3. From the **A:** prompt, copy the basic MS-DOS files to the diskette using the following command:

Format A: /F:1440 /S

Where the value 1440 is the capacity of the diskette (1.44 MB in this example).

4. Get into the PC-Doctor directory (type **CD C:\PCDR** and press **Enter**).
5. Copy the PC-Doctor files to the bootable diskette using the following command:

XCOPY C:. A:

After completion of this procedure, you should have a bootable diskette containing PC-Doctor.

5.3.5.3 Running PC-Doctor

PC-Doctor is a DOS-resident program that can be run from either hard disk or from the bootable diskette you previously created.

1. From the C:\ prompt change directory (type **CD C:\PCDR**) and press **Enter**.
2. The Diagnostics Program loads into system memory, and the LCD displays the diagnostics Header.

n

Note: There are a number of command-line switches that can be entered when starting up PC-Doctor to enable automatic virus scanning, enable loopback testing of serial/parallel ports, work from the remote menu if performing remote operations, etc. To get a listing of the available command-line switches, startup PC-Doctor with the following command: **PCDR /?** and press **Enter**.

n

Note: If PC-Doctor detects a virus, it will stop with an error message. You must then use one of the standard virus detection and removal programs to remove the virus.

5.3.5.4 Quitting PC-Doctor

To exit PC-Doctor, select the **Quit** pull down menu and then select the **Quit to DOS** option.

n

Note: For additional information, press **F1** twice to access the online *Reference manual for PC-Doctor*.

6.1 Introduction

This section contains preventive and corrective maintenance procedures for the Extensa 57x Series Notebook Computers. The first part of the section describes the computer cleaning procedures and preferred handling procedures for sensitive components (e.g. disk drives, batteries).

The second part of the section identifies all field-replaceable parts; the remainder of the section contains removal and replacement procedures for the field-replaceable parts.

6.2 Preventive Maintenance

Preventive maintenance is limited to cleaning the plastic case, the keyboard, and the display screen.

6.2.1 Cleaning the Computer

When it is necessary to clean the plastic case, glidepad and keyboard, use a soft, lint-free cloth, slightly dampened with a mild detergent solution or use the contents of any commercially available computer cleaning kit.

C

Caution: Never use alcohol, petroleum-based solvents, or harsh detergents to clean your computer. Also never spray any liquids directly on the computer case, keyboard, or screen. If the liquid-crystal display (LCD) screen has become smeared or dusty, clean the screen by first applying a mild glass cleaner to a soft, clean, lint-free cloth, and gently wipe the glass. Never apply liquids directly on the screen surface.

C

Caution: Do not use paper towels to clean the display screen. Paper can scratch the display screen matte.

6.2.2 Protecting the Disk Drives

To protect the disk drives and data, back up the system disk periodically on floppy diskettes. Periodically use a head-cleaning diskette in the floppy diskette drive to prolong the life of the drive and to help maintain data integrity.

6.2.3 Handling the Computer Battery Pack

The battery pack furnished with the computer requires reasonable care and handling to ensure efficient operation and maximum life. Periodically inspect the battery terminals and the batteries for evidence of corrosion and oxide build-up; clean if necessary.

To ensure that the battery pack endures a normal life cycle, always observe the following precautions when handling the battery pack:

- Do not drop the battery pack or subject it to excessive shock and vibration.
- Do not expose the battery pack to direct sunlight, moisture, or chemical compounds.
- Do not disassemble the battery pack.
- Do not use the battery pack to power other devices.
- Do not short the battery leads or connect the battery with reversed polarity.
- Never attempt to charge the battery pack in any way other than as described in this manual.
- Always charge the battery pack as soon as possible after a low battery indication.

6.2.4 Restoring System Software

The hard drive on the notebook computer is factory loaded with Windows 95 and ready for operation. Supplied with the Windows 95 system is a facility for creating backup diskettes of the system software. In the event of a disk crash or other problem, you can use the *Windows 95 Startup* diskette to boot the unit and perform troubleshooting.

6.3 Required Tools and Equipment

All notebook computer corrective maintenance procedures can be performed using the following tools:

- Tweezers
- Small flat-blade screwdriver
- Small Phillips screwdriver
- Hexagonal Screwdriver
- Plastic Stick

C

Caution: All boards, options and peripherals contain components that are sensitive to static electricity. When handling any of these items, protect against static electricity by using wrist or ankle grounding straps and grounded working mats. When moving or storing items, use the anti-static bags supplied with the items.

6.4 Notebook Field-Replaceable Parts and Assemblies

All members of the Extensa 57x Series Notebook Computers contain two major assemblies including the Cover Display Assembly (upper half of notebook computer) and the System Base Assembly (lower half of the notebook). Each of these two assemblies contain FRUs as described in the following subparagraphs.

6.4.1 Cover-Display Assembly

As shown in Figure 6-1, the Cover-Display Assembly contains the LCD screen, Power Inverter Board, Transfer Board and cables.

The Field-Replaceable Units (FRUs) within the Cover Display Assembly are provided in Table 6-1.

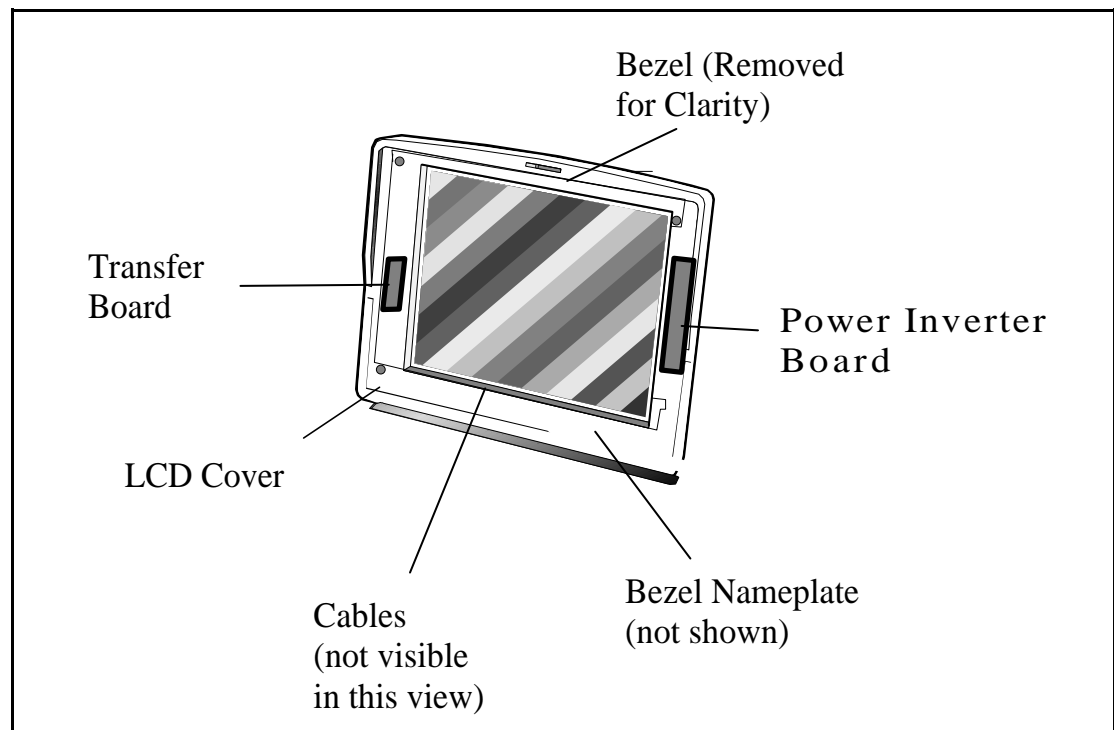

Figure 6-1 Cover Display Assembly FRUs

Table 6-1 Cover Display Assembly, Field-Replaceable Units (FRUs)

Item No.	FRU Description	TI Part No.	Reference Paragraph No.
01	Inverter Board, TFT/DSSTN	9811310-0001	6.5.15
02	11.3", DSTN SVGA LCD Panel	9811312-0001	6.5.6
03	10.4" TFT SVGA LCD Panel	9811313-0001	6.5.6
04	11.3" DSTN SVGA Cable	9811314-0001	6.5.6
05	10.4" TFT SVGA Cable	9811315-0001	6.5.6
06	Display Interconnect Board, TFT	9804800-0001	6.5.6
07	Display Interconnect Board, DSSTN	9804024-0001	6.5.6
08	TFT Panel Transfer Board	9804801-0001	6.5.6
09	DSSTN Panel Transfer Board	9804803-0001	6.5.6
10	Bezel, 11.3" DSSTN	9811320-0001	6.5.6
11	Bezel, TFT 10.4	9811321-0001	6.5.6
12	Bezel Nameplate, 570CD	9811322-0003	Ref
13	Bezel Nameplate, 575CD	9811322-0004	Ref
14	Bezel Nameplate, 570CDT	9811322-0005	Ref
15	Bezel Nameplate, 575CDT	9811322-0006	Ref
16	Hinge Covers	9805713-0001	Ref

6.4.2 System Base Assembly

As shown in Figure 6-2, the System Base Assembly houses a variety of field-replaceable subassemblies and components. The FRUs and paragraph references for removal/replacement procedures are listed in Table 6-2. Table 6-3 contains a listing of Customer (non-technical user) replaceable units (CRUs) and associated TI Part numbers.

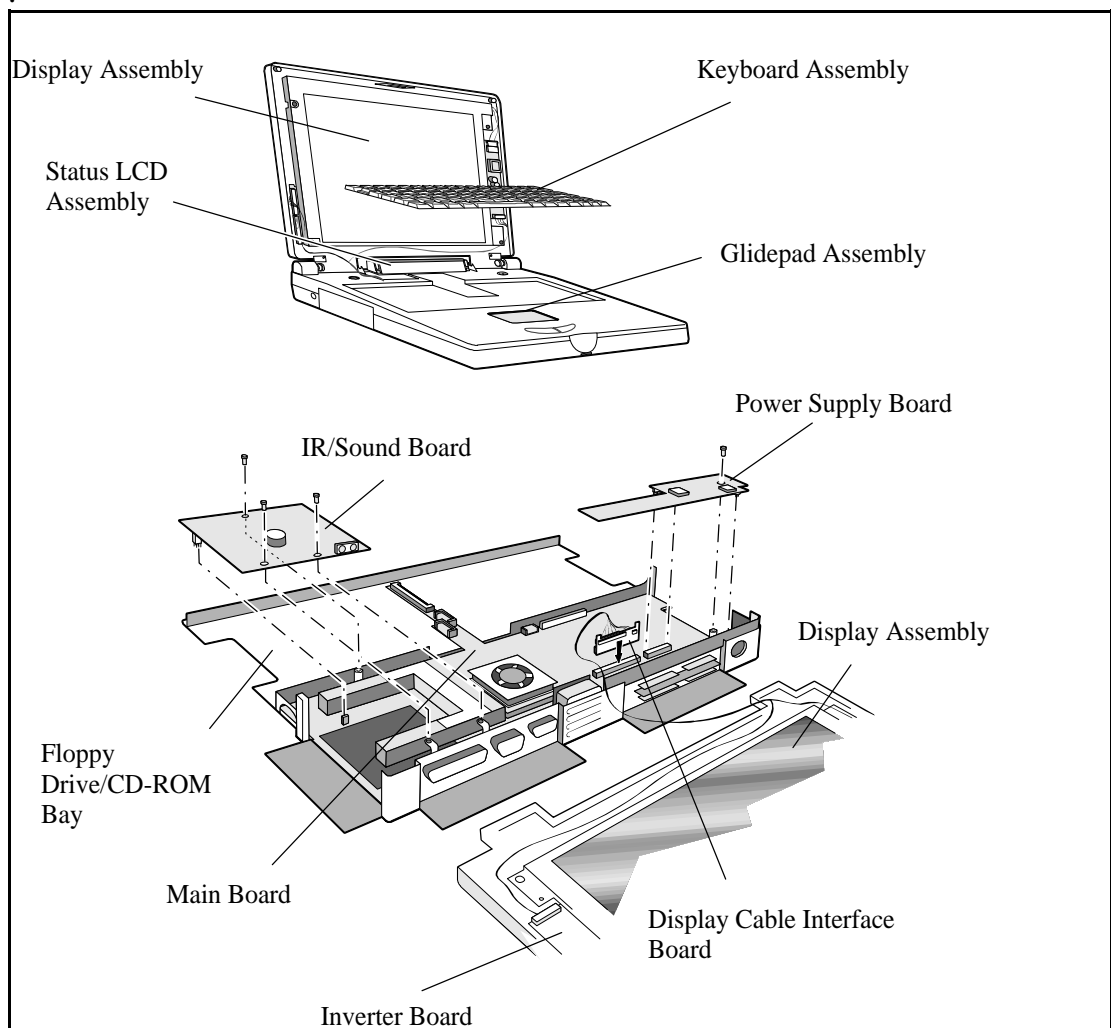

Figure 6-2 Base Assembly FRUs

Table 6-2 Base Assembly, Field-Replaceable Units (FRUs)

Item No.	FRU Description	TI Part No.	Ref. Para. No.
1	100MHZ Main Board w/CPU	9811305-0001	6.5.13
2	Power Supply, CPU	9811317-0001	6.5.13
3	Sound\IR Board Assembly (Addr. Sel.)	9811306-0001	6.5.10
4	Power Supply Assembly	9804020-0001	6.5.11
5	HDD Board Assembly, Gold Contact	9804805-0002	6.5.14
6	Status LCD Board Assembly	9804808-0001	6.5.7
7	4X CD-ROM Kit	9803982-0002	6.5.2
8	6X CD-ROM Kit	9803982-0003	6.5.2
9	810 Million Byte HDD	9786285-8001	6.5.3
10	1200 Million Byte HDD	9786285-8002	6.5.3
11	FDD Module (W/O FDD)	9804818-0001	6.5.2
12	1.44 MB FDD	9804819-0001	6.5.2
13	US Keyboard Assembly	9804820-0001	6.5.5
14	UK Keyboard Assembly	9804820-0002	6.5.5
15	German Keyboard Assembly	9804820-0003	6.5.5
16	French Keyboard Assembly	9804820-0004	6.5.5
17	Spanish Keyboard Assembly	9804820-0005	6.5.5
18	Swiss Keyboard Assembly	9804820-0006	6.5.5
19	Italian Keyboard Assembly	9804820-0007	6.5.5
20	Portuguese Keyboard Assembly	9804820-0008	6.5.5
21	Swedish Keyboard Assembly	9804820-0010	6.5.5
22	Danish Keyboard Assembly	9804820-0012	6.5.5
23	Norwegian Keyboard Assembly	9804820-0013	6.5.5
24	Belgium Keyboard Assembly	9804820-0014	6.5.5
25	Finish Keyboard Assembly	9804820-0015	6.5.5
26	CPU, P54C-100, SPGA, 2.9V	9811733-0001	6.5.13
27	Glidepad Module	9804821-0001	6.5.9

Item No.	FRU Description	TI Part No.	Ref. Para. No.
26	Speaker Cable Assembly	9805705-0001	Ref
27	Cable, Button to Glide	9805706-0001	6.5.9
28	Cable, Main Board to Button	9805707-0001	6.5.9
29	Cable, Main Board to Sound Board (2)	9805708-0001	6.5.10
30	Cable, Main Board to Sound Board (4)	9805709-0001	6.5.13
31	Cable, Main Board to Status LCD	9805710-0001	6.5.13
32	Status LCD Cover W/Lens	9805715-0001	Ref
33	CMOS Battery	9805704-0001	6.5.12
34	Door Assembly, Expansion Connector	9805719-0001	Ref
35	Door Assembly, PCMCIA	9805719-0003	Ref
36	Door Assembly, CD/FDD	9805719-0004	Ref
37	Top Case Assembly	9811304-0001	Ref

Table 6-3 Notebook CRUs (Customer Replaceable Units)

Item No.	CRU Description	TI Part No	Ref. Para. No.
1	Internal Battery Pack, Ni-MH, 4200 mAH	9803928-0003	6.5.1
2	8 MB RAM Module Kit	9809810-0001	6.5.7
3	16 MB RAM Module Kit	9804241-0001	6.5.7
4	32 B RAM Module Kit	9809811-0001	6.5.7
5	External Battery Charger	9803934-0001	Ref.
6	Full Function Port Replicator	9803936-0001	Ref.
7	Screw Covers	9805716-0001	Ref
8	Door Assembly, VGA/Ser./Par.	9805719-0002	Ref

6.5 FRU Removal and Replacement Procedures

The following paragraphs contain field service-level removal/replacement procedures for the Notebook.

C

Caution: Prior to removing any of the internal FRUs in the notebook, remove the AC Adapter, battery, floppy and hard drives and all external options installed on the notebook.

6.5.1 Removing/Replacing the Notebook Battery Pack

The procedure for removing and replacing the battery pack(s) is as follows:

1. Turn off the computer and disconnect the AC adapter and any external devices from the notebook.
2. Turn the notebook over and lay the notebook on a flat surface.
3. Locate the battery release button on the bottom of the notebook. Press the button in the direction of the arrow while sliding the battery out of its battery bay.

n

Note: Refer to Step 2 in Paragraph 6.5.2 for information on removing a secondary battery pack from the floppy drive cavity.

6.5.2 Removing/Replacing the Floppy Drive/CD-ROM

To remove and replace the Floppy Drive or CD-ROM Drive, perform the following procedure:

1. Power the notebook off; disconnect the AC adapter from the notebook (if attached) and remove the battery pack(s) as described in Paragraph 6.5.1.
2. Locate the floppy release button. Press and hold the button in the direction of the arrow while sliding the floppy drive (or other installed device such as CD-ROM drive or battery) out of the notebook bay.

C

Caution: When removing the floppy drive assembly or CD-ROM drive assembly, grasp it by its sides; otherwise damage to the floppy drive can occur.

-
3. The floppy drive assembly can be further disassembled by removing the Phillips-head screws from the sides of the floppy drive assembly; lifting off the cover and lifting out the floppy drive and cable connector (ZIF connector type). Unplug the cable at the ZIF connector.

6.5.3 Removing/Replacing the Hard Drive

The procedure for removing and replacing the hard drive assembly is as follows:

1. Power down the notebook, remove the battery packs, and disconnect the AC adapter, if installed.
2. Disconnect any peripheral device interface cables from the external interface connectors and remove any installed PCMCIA options.
3. Locate the HDD release button on the side of the notebook computer; press and hold the release button in the direction of the arrow while sliding the HDD assembly out of its bay.
4. Replacement is essentially the reverse of Steps 1 through 3.

6.5.4 Removing/Replacing Dual Inline Memory Modules (DIMMs)

To remove and replace the expansion memory, use the following procedure:

1. Power down the notebook; disconnect the AC Adapter (if attached) and remove the notebook battery packs as described in Paragraph 6.5.1.
2. Using a small Phillips head screw driver, remove the two screws that secure the RAM Access Door to the base and remove the door.
3. Push the two plastic springs away from the board edge and remove the board using a slight rocking motion.
4. When installing a DIMM board, insert the edge of the board into the rear of its connector using a slight rocking motion at an angle to the surface of the board.
5. Once the DIMM is fully inserted in the connector, push downward on both sides of the board to snap it in place.
6. Repeat steps 4 and 5 for each DIMM module being installed. Then replace hardware earlier removed in Steps 1 and 2.

6.5.5 Removing/Replacing the Keyboard Assembly

The procedure for removing and replacing the keyboard assembly is as follows:

1. Power the notebook **off**; disconnect the AC Adapter from the notebook (if attached) and remove the battery pack(s) as described in Paragraph 6.5.1.
2. The top edge of the keyboard is held in place by latches above the **PrtSc** and **F2** keys. Slide the latches toward the outer edges of the notebook.
3. Using a small straight-blade screwdriver, lift the rear edge of the keyboard and lay the keyboard over on the glidepad.
4. Unlock the keyboard ZIF connector on the main board and remove the keyboard cable; lift the keyboard out of the unit.
5. When installing the replacement keyboard, essentially reverse Steps 1 through 4.

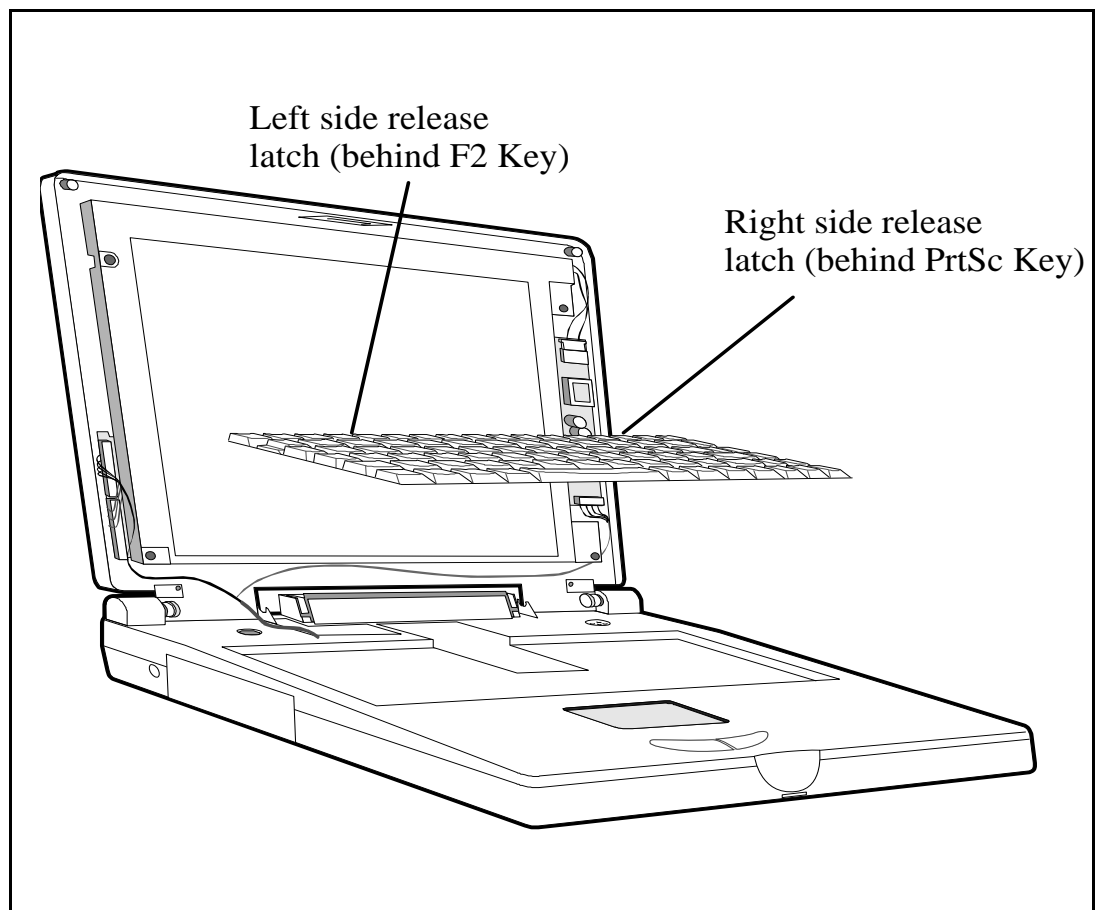

Figure 6-3 Removing/Replacing the Keyboard Assembly

6.5.6 Removing/Replacing the Display Assembly

To access FRUs in the display assembly, remove the display assembly as described in the following procedure:

1. Remove the keyboard assembly as described in Paragraph 6.5.5.
2. Lean the LCD partially back (do not lean the LCD completely back as it may cause the LCD status cover to bind).
3. Using both thumbs, press the front edge of the LCD status cover to release two latches on the rear edge of the cover. With a rocking motion, gently remove the LCD cover (**Note:** You may have to adjust the LCD cover and lift upward on the front edge of the LCD status cover).
4. Remove the screw that secures the ground cable to the Main Board (located directly below the processor).
5. Locate the display interconnect (hinge) board (plugs vertically into the main board just to the left of the CPU).
6. Using two pairs of pliers, lift upwards on the left and right side of the display cable interface board and remove the board from the unit while pulling the ground cable from the base assembly.
7. Lay the Display Assembly completely back and remove the four Phillips-head screws that secure the display hinges to the Base Case Assembly.
8. Ensure that the display cables are free from the Top Case Assembly and remove the Display Assembly.
9. Replacement is the reverse of Steps 1 through 8 above.

6.5.7 Removing and Replacing the LCD Status Assembly

To remove the LCD Status Assembly, perform the following procedure:

1. Remove the keyboard assembly as described in paragraph 6.5.5.
2. Lean the LCD partially back (do not lean the LCD completely back as it may cause the LCD status cover to bind).
3. Using both thumbs, press the front edge of the LCD status cover to release two latches on the rear edge of the cover. Press down at air vent while lifting tabs in front. With a rocking motion, gently remove the LCD cover (**Note:** You may have to adjust the LCD cover and lift upward on the front edge of the LCD status cover).
4. Remove the two Phillips-head screws and clips that secure the status LCD assembly to the base.
5. Lower the LCD cover assembly and unlock the ZIF connector on the back of the LCD status assembly using a plastic stick.

-
6. Lift the status LCD assembly out of the unit.
 7. Reinstallation of the status LCD assembly is the reverse of Steps 1 through 6.

6.5.8 Removing/Replacing the Top Case Assembly

To remove and replace the top case assembly assembly, perform the following procedure:

1. Remove the keyboard assembly as described in Paragraph 6.5.5.
2. Remove the display assembly as described in Paragraph 6.5.6.
3. Remove the LCD status assembly as described in Paragraph 6.5.7.
4. Unplug the small cable located next to the keyboard ZIF connector.
5. Flip the unit over and remove the eight screws from the base. **Do Not** remove the flat head screw at the rear of the unit next to the switch.
Note: You do not need to remove the two screws holding the RAM access door to the base assembly.
6. Remove the screw to the right of the display cable interface board (located behind the status LCD assembly).
7. Turn the unit over and lift the rear of the top case assembly one to two inches; then pull the top case towards you while keeping the base in place.
8. Reinstallation of the top case assembly is the reverse of Steps 1 through 7 above.

6.5.9 Removing/Replacing the Glidepad Assembly

To remove/replace the glidepad assembly, perform the following procedure:

1. Remove the top case assembly as described in Paragraph 6.5.8.
2. Flip the top case assembly over and lay it on a flat surface.
3. Remove the four screws that secure the glidepad board assembly to the plastics.
4. Carefully lift the glidepad board out of the plastics. Note that the glidepad is tethered to the button board by a cable and LIF connectors.
5. Replacement of the glidepad assembly is the reverse of Steps 1 through 4 above.

6.5.10 Removing/Replacing the IR/Sound Assembly

To remove and replace the IR/sound assembly, perform the following procedure:

1. Remove the top case assembly as described in Paragraph 6.5.8.

-
2. Some versions of the IR/sound board contain two cables that connect to the left side of the main board. Disconnect these cables, if present.
 3. Remove three screws that hold the IR/sound board to the unit (two screws are located at the rear which secure a rear bezel and one screw is in the front).
 4. Grasp the front left corner and front right corner of the board; remove the board from the unit.
 5. Replacement of the IR/sound board assembly is essentially the reverse of Steps 1 through 4 above.

Note: Ensure that the I/O port address switch settings on the original board match the setting of the replacement board (refer to Figure 5-3 in Section 5).

6.5.11 Removing/Replacing the Power Supply Board

To remove and replace the Power Supply Board, perform the following procedure:

1. Remove the Top Case Assembly as described in Paragraph 6.5.8
2. Remove the holding screw on the left side of the board.
3. Firmly grasp the board and use a side-to-side rocking motion while lifting up on the board.
4. When reinstalling the Power Supply Board, ensure that the plastic cap that rests on top of the Closed Cover Switch has the slanted surface facing the front of the Notebook.

6.5.12 Removing/Replacing the CMOS Battery

To remove and replace the CMOS battery, use the following procedure.

n

Note: Replacement of the CMOS battery will result in the loss of customer-definable settings. Replace CMOS battery only if the battery is defective.

1. Remove the top case assembly as described in Paragraph 6.5.8.
2. Disconnect the battery cable from the main board; lift the battery from the base.
3. Reinstall replacement battery.

6.5.13 Removing/Replacing the Main Board

To remove and replace the main board assembly, perform the following procedure:

1. Remove the top case assembly as described in Paragraph 6.5.8.
2. Using a 5 mm hexdriver, remove the four hex standoffs (shortest is located next to the PS/2 connector and the longest is located at the rear of the unit).
3. Remove the four Phillips head screws securing the main board to the base plastics.

4. Lift up on the front edge of the main board until it clears the battery cavity; then pull the main board forward and out of the plastics.
5. Reassembly is the reverse of steps 1 through 4 above.

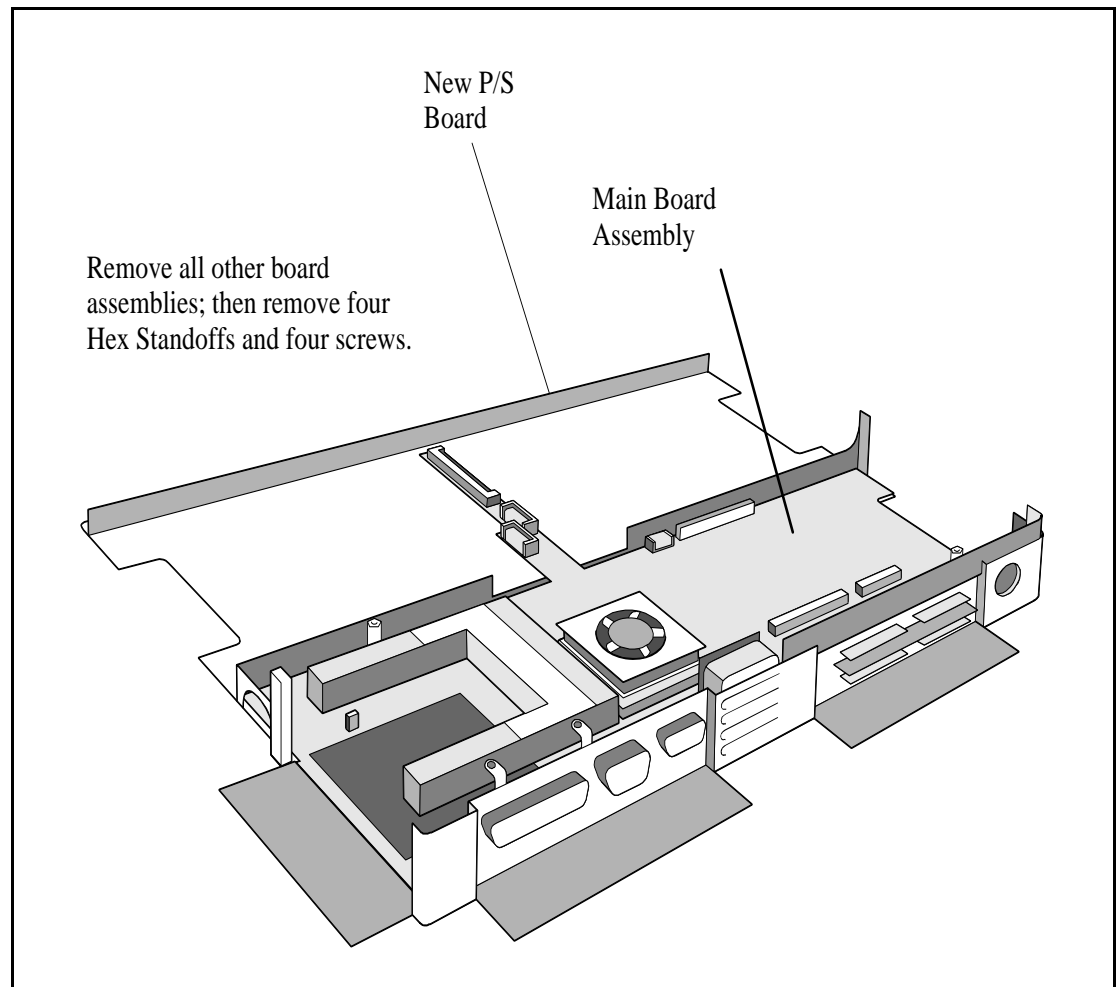

Figure 6-4 Replacing the Main Board Assembly

6.5.14 Removing/Replacing HDD Connector Board

To remove and replace the HDD connector board Assembly, perform the following procedure:

1. Remove the top case assembly as described in Paragraph 6.5.8.
2. Remove the main board assembly as described in Paragraph 6.5.13.
3. Turn the main board over and lay on a flat surface.
4. Using a small Phillips screwdriver, remove the two screws securing the HDD connector board to the main board.
5. Replacement is the reverse of Steps 1 through 4.

6.5.15 Removing/Replacing Inverter Board

To remove and replace the inverter board assembly, perform the following procedure:

C

Caution: Prior to removing the LCD bezel, ensure that the AC adapter is disconnected and that all internal battery packs are removed. Failure to observe this precaution could expose you to dangerous high voltages.

1. Remove the top case assembly as described in Paragraph 6.5.8.
2. Remove the main board assembly as described in Paragraph 6.5.13.
3. Turn the main board over and lay on a flat surface.
4. Unplug the speaker cable assembly connected to the display interface board.
5. Remove the four rubber screw covers and the four screws beneath the covers.
6. Pull on the inside edges of the bezel to remove it starting with the bottom of the bezel.
7. Disconnect the connectors at the top and bottom of the inverter board.
8. Use a small Phillips-head screwdriver to remove the two screws holding the inverter board to the plastics. Remove the inverter board.
9. To replace the inverter board, reverse Steps 1 through 8.

Appendix A

Self Test Error Messages

A.1 Introduction

This appendix contains reference data useful in diagnosing and correcting self test errors.

Table A-1 Self Test Error Messages

Error Message	Corrective Action
CMOS Battery Bad	Replace main board
CMOS Checksum Error	Cycle power to Notebook; if problem persists, replace main board.
Disk Boot Failure	Insert a system disk in drive A
Diskette Drive Controller Error or No Controller Present	Cycle power to Notebook; if problem persists, replace main board.
Diskette Drive Error	Insert Diskette and retry; if problem persists, replace drive.
Diskette Drive Type Mismatch	Press Ctrl-Alt-Esc to reconfigure the system.
Equipment Configuration Error	Press Ctrl-Alt-Esc to reconfigure the system.
Hard Disk 0 Error	Cycle power to Notebook; if problem persists, replace main board and/or hard drive.
Hard Disk 0 Extended Type Error.	Cycle power to Notebook; if problem persists, replace hard drive.
Insert system diskette and press key to reboot	Insert a system disk in drive A
I/O Parity Error	Cycle power to Notebook; if problem persists, replace main board.
Keyboard Error or No Keyboard Connected	Cycle power to Notebook; if problem persists, check keyboard cable connections to main board; if problem persists, replace keyboard and or main board.

Error Message	Corrective Action
Keyboard Interface Error	Cycle Power to Notebook; if problem persists, check keyboard cable connections to main board; if problem persists, replace keyboard and or main board.
Memory Size Mismatch	Enter and then exit the System Configuration Setup in the Setup utility.
Missing operating system	Correct the HDD type in the configuration menu and reboot. Refer to the specification label pasted on the back side of the notebook or attached to hard disk drive.
Non-system disk or disk error. Replace and strike any key when ready	Remove disk in drive A and press any key
Pointing Device Error	Cycle Power to Notebook; if problem persists, check cable connections from glidepad board to main board; if problem persists, replace glidepad board; if problem persists, replace main board.
Pointing Device Interface Error	Cycle Power to Notebook; if problem persists, open up the notebook and check the glidepad cabling
Protected Mode Test Fail	Cycle power to Notebook
RAM BIOS Bad	Cycle power to Notebook
RAM Parity Error	Cycle power to Notebook; if problem persists, replace main board and/or DIMM module (if used)
Real-Time Clock Error	Press Ctrl-Alt-Esc to reconfigure the system.
Video RAM BIOS Bad	Cycle power to Notebook; if problem persists, remove and replace the main board.

Table A-2 POST Checkpoint List

Checkpoint No.	Description
D4h	Normal POST start
FCh	CMOS and BIOS ROM checksum test skip or complete
01h	80286 register test in-progress
02h	CMOS write/read test in-progress or failure
03h	BIOS ROM checksum in-progress or failure
04h	Programmable Interval Timer test in-progress or failure
06h	DMA page register write/read test in-progress or fail
08h	RAM refresh verification in-progress or failure
09h	1st 64K RAM test in-progress
0Ah	1st 64K RAM chip or data line failure - multi-bit
0Bh	1st 64K RAM odd/even logic failure
0Ch	1st 64K RAM address line failure
0Dh	1st 64K RAM parity test in-progress or failure
10h	1st 64K RAM chip or data line failure bit 0
20h	Slave DMA register test in-progress or failure
21h	Master DMA register test in-progress or failure
22h	Master interrupt mask register test in-progress or fail
23h	Slave interrupt mask register test in-progress or fail
25h	Interrupt vector loading in-progress
27h	Keyboard controller test in-progress or failure
28h	CMOS power-fail and checksum checks in-progress
29h	CMOS config info validation in-progress
2Bh	Screen memory test in-progress or failure
2Ch	Screen initialization in-progress or failure
2Dh	Screen retrace tests in-progress or failure
2Eh	Search for video ROM in-progress
30h	Screen believed operable
34h	Timer tick interrupt test in-progress or failure

Checkpoint No.	Description
D4h	Normal POST start
35h	Shutdown test in-progress or failure
36h	Gate A20 failure
37h	Unexpected interrupt in protected mode
38h	RAM test in-progress or failure above address 0FFFFh
3Ah	Interval timer channel 2 test in-progress or failure
3Bh	Time-Of-Day clock test in-progress or failure
3Ch	Serial port test test in-progress or failure
3Dh	Parallel port test test in-progress or failure
3Eh	Math Coprocessor test in-progress or failure
50h	Initial M1429
52h	Dynamic Memory Configuration and check external Cache size
53h	Shadow BIOS
54h	Perform PCI device initialization
55h	Check CMOS checksum
56h	Check CMOS config against actual
57h	Enable/disable external cache
5Fh	Initial PnP device nodes
90h	Enable/disable external cache
70h	For PCI
71h	For PCI
72h	For PCI
73h	For PCI
74h	For PCI
75h	For PCI
76h	Begin PCI devices initialization
77h	Configures PCI VGA devices
78h	Except VGA
79h	Begin PCI service routines
7Ah	PCI Option ROM initialization

Checkpoint No.	Description
D4h	Normal POST start
E0h	Shadow PCI non-VGA option ROM
E1h	Shadow PCI VGA option ROM to C000 segment
E3h	Start to find PCI option ROM
E4h	Begin to shadow PCI option ROM
1Fh	Begin to configures PCI VGA devices
D1h	Allocate Space for option ROM

PC-Doctor Diagnostics

B.1 Introduction

The Extensa Series Notebooks are shipped with PC-Doctor, a powerful diagnostics tool that can help you determine the hardware configuration of a local or remote system, benchmark its performance, analyze the performance of all subsystems, and perform a suite of interactive and non-interactive tests on attached devices (such as printers, joystick devices, SVGA monitors, SCSI devices, CD-ROM drives). The test results are stored in a log which can be printed out (by pressing **F2**) or saved in a disk file (by pressing **F3**).

Features of the diagnostic program are accessed through a series of pull-down menus and basic keyboard keys (cursor keys to move highlighted pointer, **Enter** key to select a highlighted feature, **Esc** key to cancel a function and move back one level.)

PC-Doctor is typically user friendly but if you don't understand a feature, context-sensitive "help" information is available at any time by pressing the **F1** function key; pressing the **F1** function key twice accesses the online *Technical Reference Manual for PC-Doctor*.

A powerful set of utilities within PC-Doctor (that can be run locally or remotely) simplify the task of determining system configuration data, allocating and using system memory, IRQ and DMA use, what device drivers are installed, what COM and LPT ports are assigned and what ports are available, identifying partitioning data for fixed disk drive(s), determining the VGA setup information, reading the software interrupts/interrupt vectors, etc.

B.2 Starting PC-Doctor

PC-Doctor comes pre-installed on your Extensa Series Notebook Computer. To run the utility, reboot your computer.

The system continues the boot process and automatically displays the PC-Doctor Diagnostics main menu.

B.3 Keyboard Navigation

The keys shown in Table B-1 can be used to navigate through the PC-Doctor menus:

Table B-1 PC-Doctor Key Assignments

Key	Description
Cursor Keys	Moves the highlighted pointer.
Enter	Selects the highlighted option.
Esc	Cancels current function and goes back one step.
F1	Activates context-sensitive help.
F1 (twice)	Activates the online documentation.
PageUp/PageDn	Moves the screen one page at a time
F2	Prints the log.
F3	Saves the log to a file.

In addition, when you select **All Tests** from the Diagnostics menu, the **Test Selection** Menu that appears uses the keys listed in Table B-2:

Table B-2 Test Selection Menu Special Keys

Key	Description
Space Bar	Enables/Disables the selected test.
Enter	Enables/Disables the selected test.
F2	Activates Test Options Menu
F5	Runs the selected tests.
F10	Disables all tests.

B.4 Mouse Navigation

You can also use a mouse with the user interface. Use the left mouse button to choose objects (menu entries and action codes in square brackets). Use the right mouse button as you would the **Esc** key to take you back to your previous step. Click on the ? in the upper left corner of the screen for context-sensitive help Menus.

B.5 PC-Doctor Menus

There are several selections available from the menu bar of the PC-Doctor Diagnostics main menu. These include:

- Diagnostics
- Interactive Tests
- Hardware Info
- Utility
- Quit

B.5.1 Online Help (?)

To obtain context sensitive help from any menu, press **F1**. Pressing **F1** twice (or clicking on the question mark in the upper left-hand corner of the menu) provides you with complete online documentation.

B.5.2 Diagnostics

The Diagnostics menu allows you to run non-destructive tests with little or no operator interaction. Options available from the PC-Doctor Diagnostics Menu include:

- **System Test** - tests all major aspects of the system except those found in Memory, Hard Disk, Floppy Disk, and the Miscellaneous Test categories.
- **Memory Test** - tests all types of main memory in the system including base, extended, expanded, and upper memory block (UMB) memory.
- **Hard Disk Test** - tests all hard disk drives in the system that are either IDE or provide a BIOS command interface.
- **Floppy Disk Test** - tests all floppy disk drives in the system.
- **All Tests** - allows you to select which tests to run. You can also specify special testing options. By pressing **F2**, the following options are available:
 - **Halt On Errors** - interrupts testing if an error is detected.

n

Note: External serial and parallel port testing requires loopback plugs (not provided with this software).

- **External Loopback** - tests external loopback of COM and LPT ports. You can select the type of loopback adapter you want to use.
- **Pass Count** - selects how many times tests are repeated. The highest limit is 9999 times.
- **Test Logging** - opens the Log Options menu that lets you define how test results are printed or stored to a file during testing. By default,

PC-Doctor produces a test result file at the end of testing if an error was detected.

- **Switch LCD** - lets you change your video output to either the internal LCD, external monitor, or SimulSCAN mode. If your system does not support SimulSCAN, both the external monitor and the built-in LCD screen go blank.
- **Cache Control** - allows you to leave the level 1 and level 2 cache enabled during memory testing. This assists in tracking down cache timing issues.

B.5.3 Interactive Tests Menu

Interactive tests are diagnostics that need user interaction to complete. Interactive tests include:

- **Keyboard** - tests the keyboard keys, LEDs, and repeat rate
- **Video** - tests the character sets, colors, monitor, and VGA
- **Speaker** - tests the volume response at different frequencies
- **Mouse** - tests the mouse driver, buttons, and functionality
- **Joystick** - calibrates the joystick and tests the buttons. During the test, the joystick(s) should first be calibrated. To calibrate the joystick, move the stick to the extremes in each direction. PC-Doctor registers the coordinate data and adjusts the screen display accordingly.
- **Diskette Drive** - checks diskette drive functionality
- **Maximum System Load** - burn-in tests a system. This function simulates the operating conditions that are produced by operating systems such as OS/2 and Windows NT. Some systems are not compatible with the Maximum system Load test.
- **Printer Test** - tests for the correct acceptance and execution of common printer control commands. Printer test information is stored in printer test files with an extension of *.PDP*.
- **SCSI Test** - PC-Doctor contains SCSI device testing features that work if you have an ASPI or CAM device driver loaded. You can select which SCSI host adapter to work with if you have more than one SCSI adapter present.
- **CD-ROM Test** - tests CD-ROM drives using the Microsoft CD-ROM Extensions (MSCDEX) and the standard CD-ROM device drivers.

B.5.4 Hardware Info Menu

This menu contains functions that determine and report on the setup of the computer. None of these functions perform diagnostic tests; however any errors are included in the reports. The following functions are available from the Hardware Info menu:

- System Configuration - lists main system configuration data.
- Memory Contents - shows allocation and use of system memory

-
- IRQ and DMA use - identifies interrupts for all standard IRQ and DMA devices
 - Device Drivers - shows all essential data on DOS resident and installable device drivers
 - COM and LPT ports - displays information about the installed serial and parallel ports. Only ports that are identified by BIOS are listed
 - Physical Disk Drives - shows the basic characteristics for each installed fixed disk drive including the contents of partition tables
 - Logical Disk Drives - displays information about each drive that is available and has a disk in it. If Stacker or DoubleSpace disk compression software has been installed, details about each "stacked" or "doubled" drive is shown
 - VGA Information - identifies the type of installed VGA chip
 - Software Interrupts - displays software interrupt vectors and the area of memory they point to
 - SCSI Devices - lists information about SCSI devices and interface cards if a CAM or ASPI compliant SCSI device driver is present

B.5.5 Utility Menu

PC-Doctor has a dedicated menu for utility functions. These functions include:

- **Run External Tests** - runs other programs from PC-Doctor
- **Edit CMOS RAM** - gives access to CMOS RAM data
- **File Editor** - allows editing of configuration files
- **Surface Scan Hard Disk** - checks for defects on the hard disk
- **Benchmark System** - measures system performance
- **DOS Shell** - opens a DOS prompt from within PC-Doctor
- **Terminal** - gives access to devices connected to a serial port (such as a modem)
- **Memory Debugger** - displays memory contents in either hexadecimal, decimal, or ASCII form
- **Remote Operation** - enables remote control if available
- **Tech Support Form** - allows you to collect information about the current system
- **Battery Rundown** - quickly deep-discharges the NiMh battery of a laptop computer.

B.6 Quitting PC-Doctor

You can quit PC-Doctor in the following ways:

- **Exit (Alt-F4)** -
- **Reboot** - performs a cold boot. PC-Doctor flushes all files and attempts to flush write-caches
- **Park HD** - prepares a computer for transport

B.7 Remote Operation

This selection only appears in the Utility menu if your PC-Doctor supports remote control. This entry opens the Remote Operation menu if you are not yet online, or closes the remote connection if the system is already remotely controlled.

When PC-Doctor is operated remotely, it is possible to perform a remote reboot. Remote rebooting is a complicated procedure that reloads the operating system and makes changes to CMOS RAM and configuration files. For further information on remote operations, refer to online documentation or help.

Printed in U.S.A.

