

Tyan S1590
Trinity 100AT

Motherboard User's Manual
Revision 1.50

Copyright © Tyan Computer Corporation, 1999. All rights reserved. No part of this manual may be reproduced or translated without prior written consent from Tyan Computer Corp.

All registered and unregistered trademarks and company names contained in this manual are property of their respective companies including, but not limited to the following.

AwardBIOS is a trademark of Award Software Inc.

Windows is a trademark of Microsoft Corporation.

IBM, PC, AT, PS/2 are trademarks of IBM Corporation.

INTEL, Pentium, Pentium MMX are trademarks of Intel Corporation.

S1590 Trinity 100AT is a trademark of TYAN Computer Corporation.

Information contained in this publication has been carefully checked for accuracy and reliability. In no event will Tyan Computer be held liable for any direct or indirect, incidental or consequential damage, loss of use, loss of data, or other malady resulting from errors or inaccuracies of information contained in this manual. The information contained in this document is subject to change without notice.

PRINTED IN USA

Table of Contents

| | |
|--|-----------|
| 1. Introduction..... | 4 |
| Overview..... | 4 |
| Icons..... | 5 |
| Hardware Specifications/Features..... | 5 |
| Software Specifications..... | 7 |
| Technical Support..... | 7 |
| Returning Merchandise for Service..... | 8 |
| 2. Board Installation..... | 9 |
| Unpacking..... | 9 |
| Precautions..... | 9 |
| Installation Steps..... | 10 |
| What is a Jumper?..... | 11 |
| Map of Motherboard Jumpers..... | 12 |
| Picture of Motherboard Features..... | 13 |
| Setting Jumpers..... | 14 |
| Mounting the Motherboard in the Chassis..... | 17 |
| Installing Memory..... | 17 |
| Installing CPU and Cooling Fan..... | 21 |
| Connecting IDE and Floppy Drives..... | 22 |
| Connecting the Power Supply..... | 24 |
| Installing Add-on Cards..... | 26 |
| Connecting PS/2, USB, Serial & Parallel Devices..... | 27 |
| Frequently Asked Questions..... | 27 |
| 3. BIOS Configuration..... | 32 |
| Introduction to Setup..... | 32 |
| Main Setup Menu..... | 35 |
| Standard CMOS Setup..... | 37 |
| BIOS Features Setup..... | 40 |
| Chipset Features Setup..... | 45 |
| Power Management Setup..... | 48 |
| PnP/PCI Setup..... | 53 |
| Integrated Peripherals..... | 56 |
| User Password..... | 58 |
| Flash Writer Utility..... | 59 |
| 4. System Resources..... | 62 |
| POST Messages..... | 62 |

Appendix 1 - Glossary.....66

chapter 1

Introduction

Overview

The S1590S-100 (S1590) Trinity 100AT is a quality, high performance mainboard designed for Socket 7 microprocessors. This mainboard utilizes the VIA MVP3 100MHz AGPset and host bus speeds of 66MHz to 100MHz. For CPU speed support, please refer to the CPU Compatibility Chart in Tyan's website (http://www.tyan.com/support/html/socket_7_compatibility.html). The Trinity 100AT also has 100MHz Front Side Bus support, which allows you to take full advantage of 100MHz SDRAM memory modules.

The S1590 mainboard, with built-in AGP slot, provides high performance capabilities that are ideal for a wide range of demanding applications such as CAD, CAM, CAE, desktop publishing, 3D animation, and video production.

This system board achieves high reliability with numerous features and yet is small enough to be supported in a Baby AT form factor. Some of the features included are onboard dual channel PCI PIO, Bus Master IDE and UltraDMA/33, onboard floppy controller, and onboard high speed I/O.

Flexibility and expandability have been designed into the Trinity 100AT. With I/O and drive controller support built onboard, the one AGP slot, four PCI and four ISA slots (one shared, eight usable) are free for numerous add-on expansion cards.

Remember to take a look at TYAN Computer’s web site located at <http://www.tyan.com>. There you can find information on all of TYAN’s products along with FAQs, distributors list, drivers, and BIOS setting explanations.

Icons

In order to help you navigate this manual and set up your system, we have added several icons to our format.



This icon alerts you to particularly important details regarding the setup or maintenance of your system. This icon often appears next to information that may keep you from damaging your board or system. While we will often point out the most vital paragraphs in a chapter, you should always read every word in the text. Failing to do so can lead to exasperation and expense.



Wherever possible, we have included step-by-step instructions for setting up your system, which are indicated by this icon. However, it is in your best interest to read an entire section (and perhaps the entire manual) before you begin to fiddle with your motherboard.



While we have alerted you to potential dangers in several places in the manual with this icon, these warnings should not be regarded as the whole of your safety regimen. Never forget that computers are electrical devices, and are capable of delivering a shock. Prevent damage to yourself and to your board: always ensure that your system is turned off and unplugged whenever you are working with it, and that you are equipped with a static safety device.

Hardware Specifications/Features

- Processor Information***
- Intel Pentium/Pentium MMX
 - AMD K5/K6/K6-2
 - Cyrix/IBM 6x86/6x86MX
 - IDT C6/C6+
 - Maximum rated bus speed 100MHz

Chipset Information

- VIA MVP3 AGPset.

Voltage and Power Information

- AT/ATX power supply connectors.
- +12V power source for DC fan onboard.
- 3.3V or 5.0V DRAM support.
- Utilizes GTL+ bus to reduce power consumption and EMI.
- Switching power supply onboard.
- Wake-on LAN 3-pin header (requires ATX 2.01 compliant power supply).

Main Memory

- Up to 384MB onboard.
- Three 168-pin DIMM sockets.
- Two 72-pin SIMM sockets.
- Maximum rated memory bus speed 100MHz.
- Supports EDO, SDRAM, Parity, and ECC (ECC only with Parity memory).
- 1024KB level 2 pipeline burst cache

Expansion Slots

- One 32-bit AGP slot.
- Four 32-bit PCI Bus Master slots.
- Four 16-bit ISA slots.
- One shared, eight usable slots.
- Maximum rated PCI bus speed 33MHz

Physical Dimensions

- Mini AT design.
- 11.1 inches x 8.75 inches (reduced form factor).

BIOS Information

- Award Plug and Play flash BIOS.
- Deep Green, Energy Star, Year 2000, ACPI, PC97-98, DMI 2.0 compliant.
- PC-98 ready.
- Soft power down, multiple boot options.

Disk Drive & System I/O

- UltraDMA/33 (UIDE) built-in (up to 33MB/s DTR).
- Two PCI bus mastering EIDE channels.
- Supports EIDE CD-ROMs.
- PIO Mode 3+4 (up to 17MB/s DTR).
- Bus mastering mode (up to 22MB/s DTR).
- Support for two floppy drives

(supports Mode 3 and up to 2.88MB).

- Two serial ports (16550 UARTs).
- One ECP/EPP parallel port.
- One IR (InfraRed) I/O interface port header.
- Two USB rev 1.2 port headers.
- One PS/2 mouse port.
- One AT keyboard connector.

* For the latest CPU compatibility list see www.tyan.com

Software Specifications

OS

- Operates with MS-DOS, Windows 3.x, Windows for WorkGroup 3.x, Windows 95, Windows 98, Windows NT, OS/2, Novell Netware, Solaris, and SCO Unix.

Technical Support

If a problem arises with your system, you should turn to your dealer for help first. Your system has most likely been configured by them, and they should have the best idea of what hardware and software your system contains. Hence, they should be of the most assistance. Further, if you purchased your system from a dealer near to you, you can actually bring your system in to them to have it serviced, instead of attempting to do so yourself (which can have expensive consequences).

Help resources:

1. See FAQ and beep codes sections of this manual.
2. See Tyan web site for FAQ, bulletins, driver updates, etc.
<http://www.tyan.com>
3. Contact your dealer or distributor for help BEFORE calling Tyan.
4. Email Tyan tech support: techsupport@tyan.com
5. Call Tyan tech support: 510-440-8808

Returning Merchandise for Service

During the warranty period, contact your distributor or system vendor **FIRST** for any product problems. This warranty only covers normal customer use and does not cover damages incurred during shipping or failure due to the alteration, misuse, abuse, or improper maintenance of products.

For Resellers Only:

A receipt or copy of your invoice marked with the date of purchase is required before any warranty service can be rendered. You can obtain service by calling the manufacturer for a Return Merchandise Authorization (RMA) number. The RMA number should be prominently displayed on the outside of the shipping carton and the package should be mailed prepaid, or hand-carried to the manufacturer. TYAN will pay to have the board shipped back to you.

chapter 2

Board Installation

Unpacking

The mainboard package should contain the following:

- (1) S1590 mainboard
- (1) 40-pin IDE and 34-pin floppy cable pack
- (1) S1590 User's Manual
- (1) Serial/parallel cable set
- (1) PS/2 mouse cable
- (1) Driver CD

Precautions

What's the first thing I should do?

The first thing you should do is read this user's manual. It contains important information which will make configuration and setup much easier.

Here are some precautions you should follow when installing your motherboard:



- (1) **Ground yourself properly before removing your motherboard from the antistatic bag.** Unplug the power from your computer and then touch any metal part on the computer case. (Or wear a grounded wrist strap.)
- (2) **Hold the motherboard by its edges and do not touch the bottom of the board.**
- (3) **Avoid touching motherboard components, IC chips, connectors, and leads.**
- (4) **Avoid touching pins of memory modules and chips.**
- (5) **Place motherboard on a grounded antistatic surface or on the antistatic bag.**

Having reviewed the precautions above, the next step is to take the motherboard out of the cardboard box and static bag, hold it by its edges, and place it on a grounded antistatic surface, component side up. Inspect the board for damage.



DO NOT APPLY POWER TO THE BOARD IF IT HAS BEEN DAMAGED!

Press down on any of the socket ICs if it appears that they are not properly seated (the board should still be on an antistatic mat). Do not touch the bottom of the board. Remember, don't take any electronic device out of its protective bag until you are ready to actually install it into the computer case. If you do not ground yourself, you risk zapping the motherboard or adapter card. Subsequent problems may not arise immediately because electrostatic discharge damage, unlike physical damage, causes the device to fail over time.

***Power Supply Requirement: If you use an ATX Power Supply, it should be 2.01 compliant. Standby current must be 750mA or higher (SB5V = 0.75A)**

Installation Steps

You are now ready to install your mainboard. The mounting hole pattern of the S1590 matches the Baby AT system board specifications. Your chassis should have standard AT mainboard form factor mounting holes and either an AT or ATX power supply.



1. Set Jumpers
2. Mount Motherboard in Chassis
3. Install Memory

4. Install CPU & Cooling Fan
5. Connect IDE and Floppy Drives
6. Connect Power Supply
7. Install Add-on Cards
8. Connect PS/2, USB, Serial and Parallel Devices

What is a Jumper?

In this manual, the terms “closed” and “on” are used when referring to jumpers (or jumper pins) that are active; “open” and “off” are used when referring to jumpers (or jumper pins) that are inactive. See the **Figure 2-1** for examples of “on” and “off” pins and jumpers. The square pin in the diagram is Pin 1.

Jumpers and pins are connected by slipping the blue plastic jumper connector overtop of two adjacent jumper pins (indicated by **1-2** or **2-3**). The metal rod

inside the plastic shell bridges the gap between the two pins, completing the circuit. See **Figure 2-2** for more examples of pin connections.

The tables and maps on the following pages will help you set the jumpers for CPU speed, Infrared, and external connector pin assignments, among others. The miniature motherboard maps will help you locate the jumpers on your board. A full-page map of the motherboard can be found on the next two pages.

2 pin jumpers

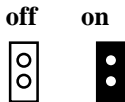

Figure 2-1

3 (or more) pin jumpers

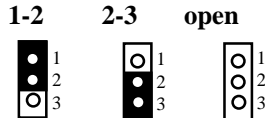
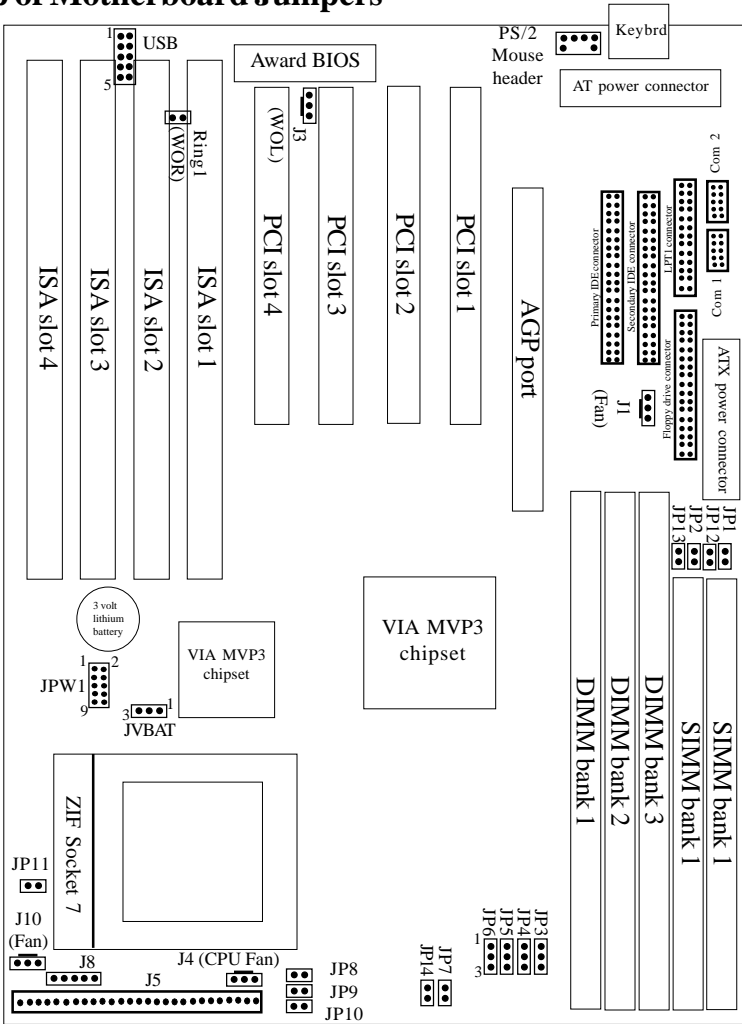

Figure 2-2

Map of Motherboard Jumpers



The tiny number “1”s next to jumpers of 3 pins or more indicate the position of pin 1 for that jumper.

Picture of Motherboard Features

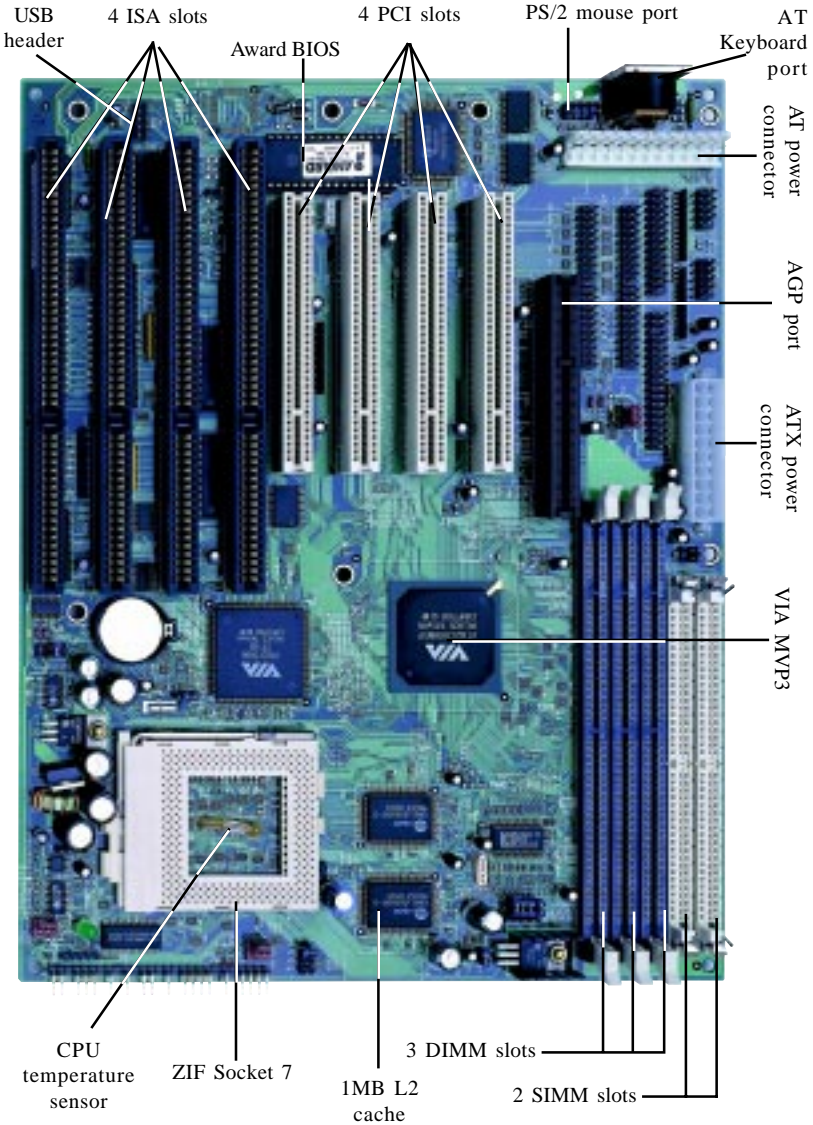

INSTALL

1. Setting Jumpers

1-A. CPU Bus Speed Settings

| Bus Speed | JP3 | JP4 | JP5 |
|-----------|-----|-----|-----|
| 60MHz | 2-3 | 2-3 | 2-3 |
| 66MHz | 1-2 | 2-3 | 2-3 |
| 75MHz | 1-2 | 1-2 | 2-3 |
| 83MHz | 1-2 | 2-3 | 1-2 |
| 95MHz | 2-3 | 1-2 | 1-2 |
| 100MHz | 1-2 | 1-2 | 1-2 |

1-B. CPU Clock Multiplier

| Multiplier | JP8 | JP9 | JP10 |
|------------|-----|-----|------|
| 1.5x | OFF | OFF | OFF |
| 2.5x | ON | ON | OFF |
| 3x | ON | OFF | OFF |
| 3.5x | OFF | OFF | OFF |
| 4x | OFF | ON | ON |
| 4.5x | ON | ON | ON |
| 5x | ON | OFF | ON |

1-C. CPU Core Voltage Settings

| JPW1 | 2.0V | 2.1V | 2.2V** | 2.3V | 2.4V | 2.7V | 2.8V | 2.9V | 3.2V | 3.3V |
|------|------|------|--------|------|------|------|------|------|------|------|
| 1-2 | OFF | ON | OFF | ON | OFF | ON | OFF | ON | OFF | ON |
| 3-4 | ON | OFF | ON | ON | OFF | ON | OFF | OFF | OFF | OFF |
| 5-6 | ON | OFF | OFF | OFF | ON | ON | OFF | OFF | ON | ON |
| 7-8 | ON | OFF | OFF | OFF | OFF | OFF | ON | ON | ON | ON |
| 9-10 | ON | OFF | OFF | OFF | OFF | OFF | OFF | OFF | OFF | OFF |

** Default Setting (2.2V)

The CPU speed is controlled by setting the bus speed and the multiplier with the jumpers described above that are appropriate for your CPU and memory.

You must have a 100MHz processor AND PC/100 memory to run at a bus speed of 100MHz.

Tyan does not recommend operating CPUs, memory or PCI bus at higher than rated speed. Tyan takes no responsibility for any problems related to overlocking any bus or component on the system board.



1-D. JP11 Split Voltage Setting

| | JP11 |
|--------------------------|------|
| CPU $V_{Core} = V_{I/O}$ | ON |
| Default | OFF |

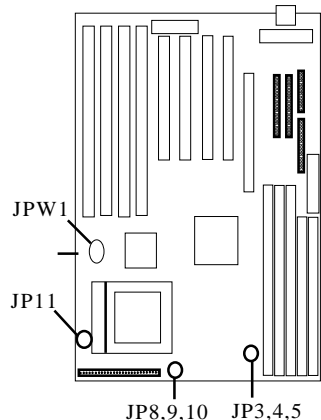

JP11 is used to set CPU I/O voltage. Most newer P55C type CPUs such as AMD K6/K6-2 have 3.3V I/O voltage and a lower core voltage, so this jumper should be OFF. For certain older P54C type CPUs the Core voltage is the same as the I/O voltage so this jumper should be closed (on). Check the specs on your CPU before you set this jumper.

1-E. SIMM Voltage Settings

| SIMM Voltage | JP1, JP12 | JP2, JP13 |
|--------------|-----------|-----------|
| 5V | ON | OFF |
| 3V | OFF | ON |

1-F. Memory (DIMM) Clock Speed

| Same as: | JP6 |
|-----------|-----|
| CPU Clock | 1-2 |
| AGP Clock | 2-3 |

Note: AGP Clock Speed is 66MHz.
CPU Clock Speed is set in section 1-A on previous page.

1-G. J5 External Pin Assignments

| Pins | 1-2 | 6-11 | 13-16 | 18-20 | 22-23 | 24-27 |
|------------|-------------------------|--------------------------------------|-----------------------------|------------------------------|--------------------|---|
| Function | Power On/Off | InfraRed | HDD LED | Power LED | Reset Switch | Speaker |
| Assignment | 1=Power On/Off 2=GND | 6=5V 8=IR RX 9=GND 10=IR TX | 13=5V 15=LED- 16=LED+ | 18=Sleep LED 20=Power LED | 22=GND 23=Reset | 24=5V 26=Internal Speaker 27=Speaker- |

1-H. Power Supply Type**

| | JP7, JP14 |
|------------------|-----------|
| AT power supply | ON |
| ATX power supply | OFF |

****Note:** JP7 and JP14 are provided on some S1590 boards. If your board does not have JP7 and JP14, please disregard the above chart - the correct settings are already built-in to the motherboard.

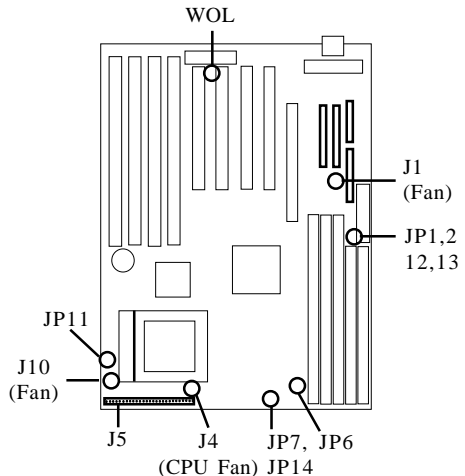

1-J. Other Pin Assignments

| | 1 | 2 | 3 |
|------------------------------|-----------------------------------|-----|------------------------------|
| J3 (Wake-on LAN) | Standby 5V | GND | Wake (Power On, Active High) |
| Fans J1, J4 & J10 | GND | VCC | Fan Monitor |
| J8 (keylock) | Keylock header for older AT cases | | |

Hardware CMOS & Password Reset

If you have been locked out of your system because you forgot your password or set the CMOS incorrectly, follow the instructions below.

1. Power off the system
2. Set jumper JVBAT1 to pins 2 and 3
3. Wait for 2 seconds, then return jumper JVBAT1 to pins 1 and 2.
4. Power on the system again.

| | JVBAT1 |
|-------------------|--------|
| Default | 1-2 |
| Reset CMOS | 2-3 |

By following this procedure, you will erase your password and reset the CMOS to the BIOS defaults.

Soft Power Connector

The Soft Power Connector is located on pins 1 and 2 of jumper block J5. Pressing the Soft Power Button will turn the system on and off. Holding this button for more than four seconds (when the system is on) will power down the system. Pressing it again will reboot the system.

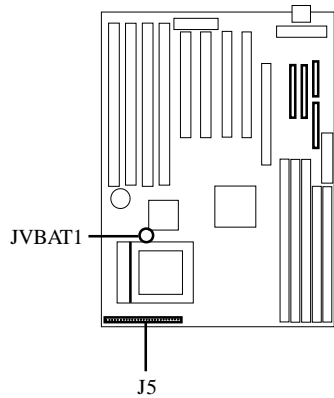

Speaker Connector Installation

The Trinity 100AT provides a 4-pin header to connect the speaker. The speaker is connected to pins 24-27 of jumper block J5.

Hardware Reset Switch Connector Installation

The Reset switch on your case's display panel provides you with the Hardware Reset function, which is the same as power on/off. The system will do a cold start after the Reset button is pushed. The Reset switch is a 2-pin connector and should be installed on pins 22 and 23 of jumper block J5.

CMOS RTC

The VIA MVP3 AGPset includes a Real Time Clock (RTC) circuit, which provides the date and time for the system. If the external battery for the RTC is low, it will prevent your system from POSTing, and you will not get a display. Normally the life span of an external battery is 2 years. If yours is running low, you will need to replace it with a new 3V lithium battery (Sony CR2032).

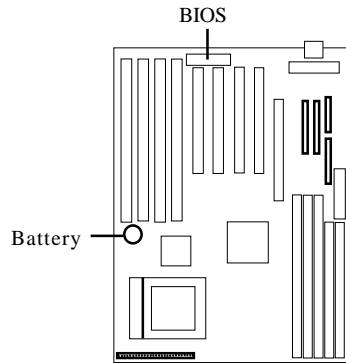

Flash EEPROM

The Trinity 100AT uses flash memory to store BIOS programs. It can be easily updated if necessary using the flash utility (see page 59). Tyan does not recommend flashing the BIOS unnecessarily. Check the Tyan web site for the latest BIOS revision.

2. Mounting the Motherboard in the Chassis

Follow the instructions provided by the case manufacturer for proper installation guidelines. TYAN recommends that you use only one screw to hold down the motherboard. The rest of the mounting holes should be used for the plastic standoffs. If your case does not have a hole for a standoff, simply cut off the bottom of the plastic standoff so that the flat portion rests on the metal. The adapter cards and the screws holding them down will keep your board flat. The fastening screw should not short any of the traces on the motherboard. Make certain that you do not overtighten the screw, as it will damage the motherboard and possibly break internal traces in the surrounding area. The hole you should use is located at the top-center of the board where the adapter cards are fastened to the case.



3. Installing Memory

Since TYAN boards are manufactured with performance in mind, you should use add-in components that match. Some DIMM modules may seem to be high quality because of name or feel but that does not guarantee real-world usability. Some cheaper or OEM memory may have brand-name components, but they may contain inferior or substandard parts which do not meet the critical tolerances our products require. Because of this, your memory may not work correctly in a TYAN board though it may work well in a competitor's

board. This is because many of our competitors do not adhere to the strict tolerances required for high performance. If you buy a TYAN board, you are getting the best system available. To make installation easy and trouble free, get high quality parts. Some brands we recommend are Corsair Microsystems, Kingston Memory, and QesTec Incorporated. These DIMMs have proven to be very stable on our boards and perform extremely well.

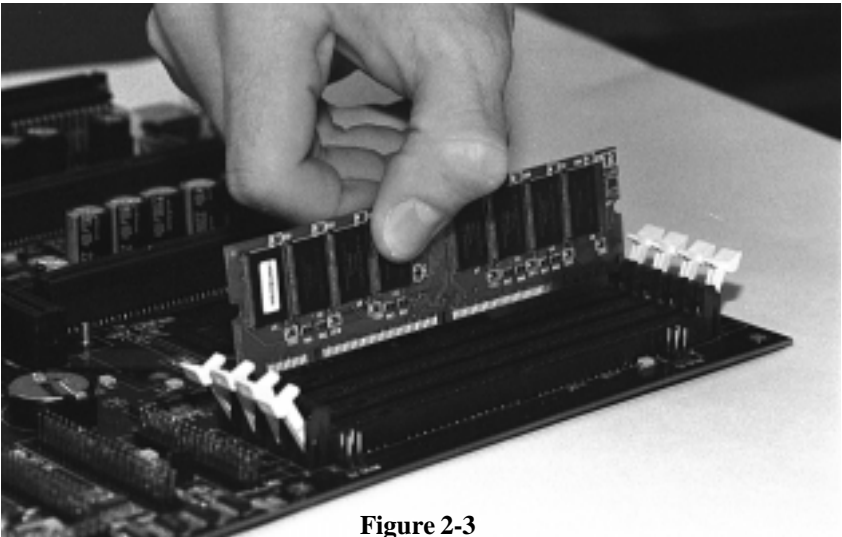

Figure 2-3

To install your DIMMs, line your module up so that the pins fit into the slot. There is only one way that your DIMM can fit properly. Make sure that the short row of pins is lined up with the short gap in the DIMM slot. Figure 2-3 above shows how to sit the DIMM into its slot. To insert the DIMM, push down vertically on the module with even force, as shown in the photo. Do not shove one end in first; doing so will bend the DIMM pins.

To lock the DIMM into place, push the plastic clips on either end of the slot onto the notches in the ends of the DIMM (see Figure 2-4 on the next page). To remove your DIMM, simply pull the clips back, and pull up on the module.

Place the DIMMs in an anti-static bag as soon as you remove them to avoid static damage.

The Trinity 100AT uses a 64-bit data path from memory to CPU and can accommodate up to 384MB of SDRAM. The 168-pin DIMMs (Dual In-line Memory Modules) must be of the 3.3V, **unbuffered** variety. The position of the

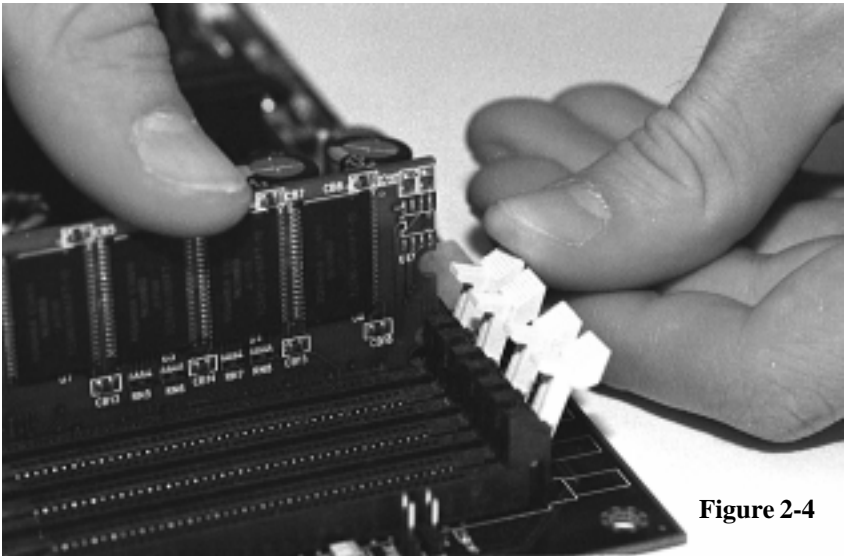

Figure 2-4

notch in the SDRAM key position will tell you whether or not a DIMM is unbuffered (see the Figure 2-5 below). All installed memory will be automatically detected, so there is no need to set any jumpers.

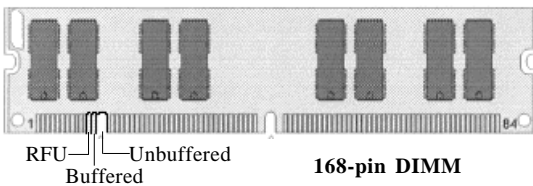

Figure 2-5

Some details of memory installation:



important!

- At least one unbuffered DIMM must be installed for the system to POST.
- The mainboard supports 32MB, 64MB, 128MB SDRAM.
- PC-100 DIMM is required if CPU bus speed is at 100MHz
- EDO, SDRAM, Parity, and ECC (using Parity memory) memory is supported.
- SIMM modules must be installed in pairs, and both must be of the same size and type.
- The mainboard supports 4MB, 8MB, 16MB, 32MB, and 64MB SIMMs.
- You can install either single- or double-sided SIMMs.
- Two SIMMs or one unbuffered DIMM must be installed for the system to

POST.

The table below shows some of the possible memory configurations. Not all possible configurations are listed.

| DIMM Bank 1 | DIMM Bank 2 | DIMM Bank 3 | SIMM Bank 1 | Total |
|-------------|-------------|-------------|-------------|-------|
| 8MBx1 | 0 | 0 | 0 | 8MB |
| 8MBx1 | 8MBx1 | 0 | 0 | 16MB |
| 8MBx1 | 8MBx1 | 8MBx1 | 0 | 24MB |
| 16MBx1 | 8MBx1 | 8MBx1 | 0 | 32MB |
| 0 | 16MBx1 | 16MBx1 | 8MBx2 | 48MB |
| 16MBx1 | 16MBx1 | 16MBx1 | 0 | 48MB |
| 32MBx1 | 16MBx1 | 16MBx1 | 0 | 64MB |
| 32MBx1 | 32MBx1 | 8MBx1 | 0 | 72MB |
| 0 | 32MBx1 | 32MBx1 | 16MBx2 | 96MB |
| 64MBx1 | 32MBx1 | 32MBx1 | 0 | 128MB |
| 64MBx1 | 64MBx1 | 32MBx1 | 0 | 160MB |
| 64MBx1 | 64MBx1 | 64MBx1 | 0 | 192MB |
| 128MBx1 | 64MBx1 | 64MBx1 | 0 | 256MB |
| 128MBx1 | 128MBx1 | 64MBx1 | 0 | 320MB |
| 128MBx1 | 128MBx1 | 128MBx1 | 0 | 384MB |

**Note: You can NOT use DIMM Bank 1 and SIMM Bank 1 at the same time!
 Bank 1 can not be shared!**

Cache Memory

The S1590 has 1024Kbit of onboard pipeline burst SRAM. This SRAM cannot be upgraded.

4. Installing the CPU and Cooling Fan

Socket 7 processors (see Specifications on page 5) can be used on the Trinity 100AT. Please refer to page 14 for the correct CPU jumper settings for your CPU.

Remember:



- The CPU is a sensitive electronic component and it can easily be damaged by static electricity. Do not touch the CPU pins with your fingers.
- Before the CPU is installed, the mainboard must be placed on a flat surface. You should be able to insert the CPU with minimal, but firm, pressure. Do not press down hard on the CPU.

In Figure 2-6, you can see the CPU and the ZIF socket. Notice that the arm of the ZIF socket is up. When this arm is up, the CPU is unlocked from the socket and allows you to remove or install a CPU. As the ZIF socket is keyed to the processor that you are using, you will only be able to install the CPU one way, thus eliminating the chance for error.

Pin 1 on the CPU is denoted by a small dot on one of the corners and Pin 1 on the ZIF socket is denoted by an angled corner. Never force a CPU into a socket. Forcing a CPU to seat will bend the pins on the CPU and possibly damage the motherboard. Check with your vendor or manufacturer for proper voltage selection.



Figure 2-6

Push down lightly on the CPU, and lower the arm on the ZIF socket to secure the CPU. A squeaking noise is normal as the arm lowers. After the CPU is securely seated, install the appropriate cooling device (Figure 2-7). Tyan strongly recommends a heatsink/fan combination. Consult with your case manufacturer for other cooling options.

Locate the cooling fan connector (e.g. CPU Fan, J4) on the motherboard. Plug the CPU's cooling fan cable into the cooling fan connector on the board. There



Figure 2-7

will be a plastic clip assembly similar to that of the ATX power connector that will force you to connect the fan cable correctly (see Figure 2-8 below).

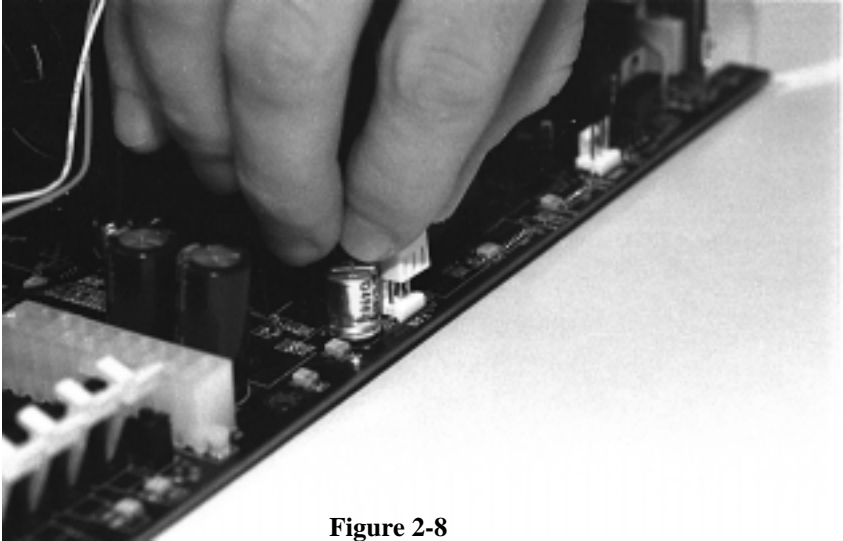

Figure 2-8

5. Connecting IDE and Floppy Drives

The colored stripe on a ribbon cable should face toward the keyboard connector. In Figure 2-9 on the next page, you can see how the IDE cables should look when they are connected to your hard drive. Notice how Pin 1 (denoted by a red stripe) is connected so that it is next to the power connector of the drive. The primary IDE connector is black; the secondary IDE connector is white.

In most cases, this is the proper way of connecting your IDE cable to the harddrive. Figure 2-10 on the next page shows the IDE cable properly connected to the motherboard. Contact your hard disk drive manufacturer or documentation for more information.

Some symptoms of incorrectly installed HDDs are:

- Hard disk drives are not auto-detected: may be a Master / Slave problem or a bad IDE cable. Contact your vendor.
- Hard Disk Drive Fail message at bootup: may be a bad cable or lack of power going to the drive.

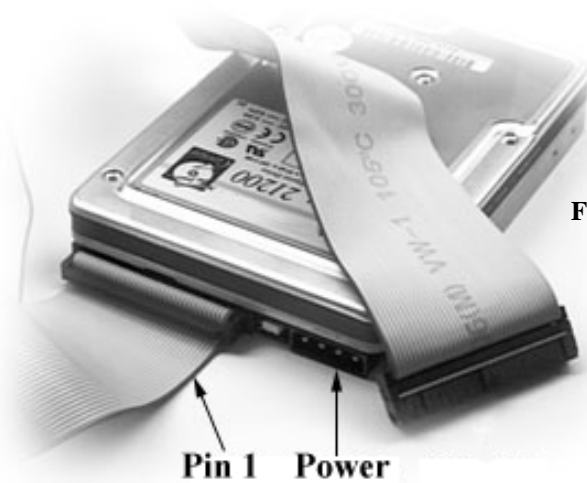

Figure 2-9

- No video or beeps on bootup: usually means the cable is on backwards.
- Hard drive lights are constantly on: bad IDE cable or defective drives/motherboard. Try another HDD.
- Hard drives do not power up: check power cables and cabling. May also be caused by a bad power supply or IDE drive.

Connecting Floppy Drives

Pin 1 on the floppy cable is usually denoted by a red or colored stripe down one side of the cable (see Figure 2-11 on the following page). Most of the current floppy drives on the market require that the colored stripe be positioned so that it is right next to the power connector. In most cases, there will be a key pin on the cable which will force you to connect the cable properly. Drive A: is usually attached to the end of the cable with the twist in it. Drive B: is usually connected to the middle of the cable. Refer to your installation

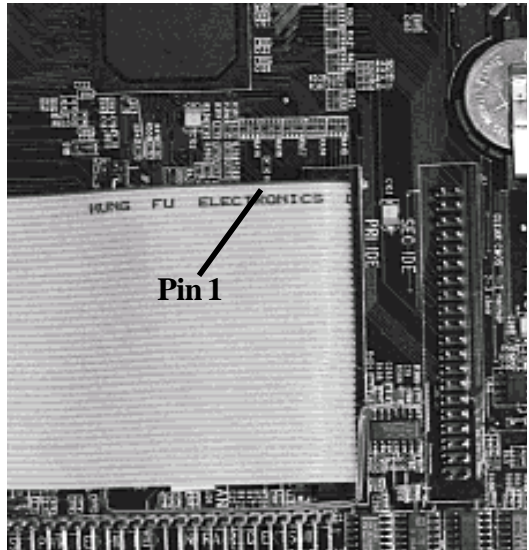

Figure 2-10

Chapter 2

Board Installation

instructions or call your dealer if you are unsure about attaching floppy drives. Refer to Figure 2-11 for a detailed anatomy of the floppy cable. Remember, you can only have 2 floppy drives connected at any given time.

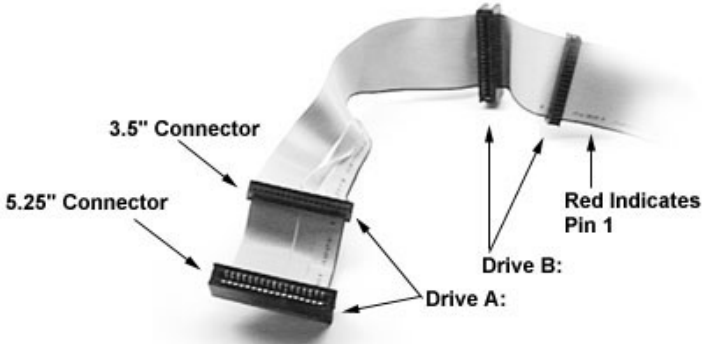

Figure 2-11

Some symptoms of incorrectly installed floppies are:

- Floppy drives are not detected: usually caused by faulty cables, backward cables, or a bad floppy or motherboard. Try another single floppy drive to verify the problem or try another cable. Also, check to see if the onboard floppy is enabled in the BIOS.
- Floppy Drive Fail message at bootup: the cable, floppy, or motherboard may be faulty. Try another cable or floppy drive to verify.
- Light on the floppy is on constantly: a dead giveaway that the cable is on backwards. Reverse the cable at the motherboard end and try again.

6. Connecting the Power Supply

The Trinity 100AT has both AT and ATX power supply connectors. The photos below show the ATX power connector before (Figure 2-12) and after (Figure 2-13) it has been plugged in. The plastic clip on the power connector should lock over the plastic tab on the onboard connector. You shouldn't be able to plug the power connector in any other way but just to be safe, make sure it looks like Figure 2-13.



Figure 2-12

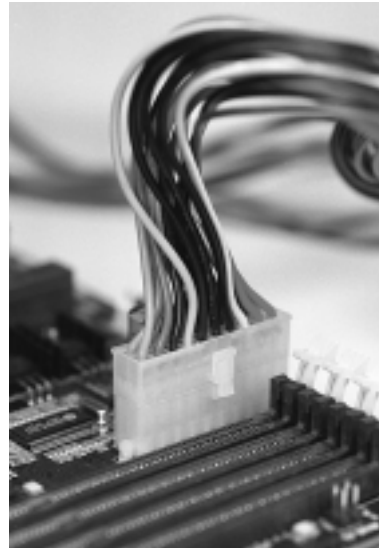

Figure 2-13



Make absolutely certain that you do not miss any pins, because if you do you will void your warranty and cause damage to yourself or your motherboard when you turn the system on. After connecting the power, make sure the connector is seated firmly into its socket so it will not become loose or fall off when the computer is jostled or moved. Note: If you use an ATX power supply, Tyan recommends using one that conforms to industry standard revision 2.01.

If you decide to use an AT power supply instead, connect the power supply to the board as shown in Figure 2-14 (on the following page). You must set jumper JP7 according to which type of power supply you have (see p.15).

Note that the black wires are in the center of the two connectors. You should not be able to plug the two power connectors in any other way but just to be safe, make sure you have them connected as shown above. Make absolutely certain that you do not miss any pins because if you do, you will void your warranty and cause damage to yourself or your motherboard when you turn the system on. After connecting the power, make sure the connectors are seated firmly into their sockets so they will not become loose or fall off during movement of the computer.

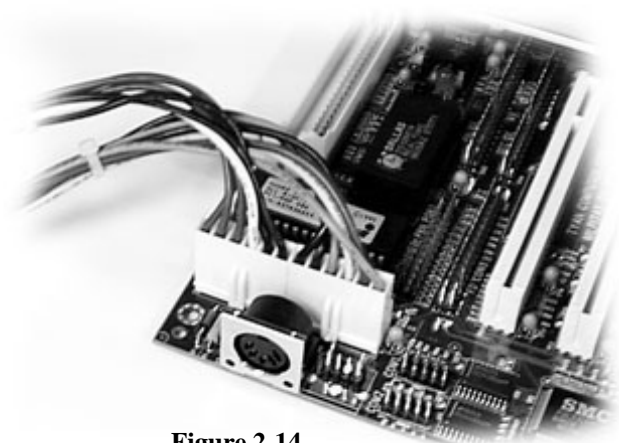

Figure 2-14

7. Installing Add-on Cards

There are a few rules you need to follow when plugging in a card. In order to assure proper operation and a quick installation, adhere to these guidelines:



important!

- If you are going to install a PCI-Bus interface card on your system, be aware that any one of the two PCI slots can support a Master or Slave device.
- NEVER force a card into a slot. If it doesn't fit, look at the socket on the computer to make sure there are no wires or other obstructions to the slot.
- NEVER plug an ISA card into a PCI slot or a PCI card in an ISA slot. You will void your warranty and damage your system board if you do this.
- When plugging the card in, especially when installing long cards, try to push the entire card in at one time. Don't force one end of the card into the socket first and then the other. This will create a rocking motion between the card and the slot and it will damage the pins within the socket.
- Make sure that the cards are seated securely into the slots.
- Before turning on the system, make sure no cards are touching

If you follow these basic guidelines, there shouldn't be any problems with installation. However, if you do encounter any problems, have a qualified professional install your cards for you or contact your card manufacturer.

Remember, always read the manuals and installation notes that come with the adapter cards. They contain important information which will help you install the components right, the first time.

8. Connecting PS/2, USB, Serial & Parallel Devices

Connecting Com and Printer Ports

Like the IDE and floppy cables, the colored or red edge of the cable always denotes pin 1 (Figure 2-15). Similarly, pin 1 on the motherboard is always pointing towards the keyboard connector or edge of the board. TYAN cables conform to the IBM standard pinouts and will differ from most other manufacturers'.



Other cables will not work on TYAN boards. The Printer and Com1 ports are on the same back plate. You want to make sure that you correctly align the connectors with the pins on the board because they are easy to miss. On most TYAN cables, there should be a pin missing on the motherboard. This is normal since it lines up with a key pin on the I/O connectors. This forces you to align the connector in the correct direction. The Printer port and Com2 are easily confused. The Printer cable is always attached with Com1 (Figure 2-16 on the following page) where Com2 is supplied separately on a second back plate (Figure 2-17 on the following page). Remember: Only TYAN cables will work on this motherboard. If you are using an existing case with old cables, your system will not function properly. Use only TYAN-approved connectors.

Figure 2-16

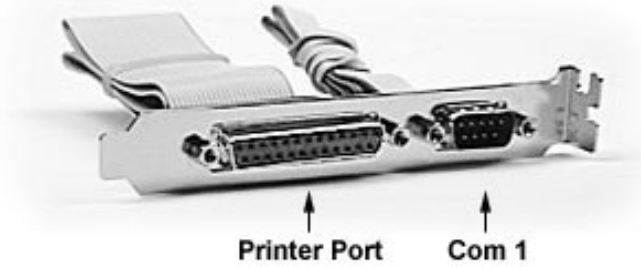

Figure 2-17



Connecting the PS/2 mouse.

This board has a PS/2 mouse header built in. Simply plug the PS/2 mouse cable into the header on the motherboard and plug your PS/2 mouse into the PS/2 port; the pins will allow you to plug the mouse in only in the correct way. If you have any trouble locating the port, turn to the full page motherboard map on page 12.

Warning: When plugging in your keyboard and mouse, or when plugging anything into a serial or Com port, make sure that the power is off. Connecting these devices and ports while the power is on is called “hot plugging,” and may damage your system.

You are done!

Other than checking the jumper settings and cable connections and putting the case back on, you are done. Installing a new motherboard may sound difficult, but by following these directions, you should have had a fairly uneventful time installing our products. If you did encounter problems, your dealer will be able to help you, or you can consult one of our many technical support resources (see page 7).

Frequently Asked Questions

Q: My system sometimes becomes unstable. How should I check the system?

A: The first thing to do is to check and see if you have any device conflict in address, IRQ, or DMA. If you are using Windows 95, the Device Manager is a good place to start. Please consult your operating system manual for details. Second of all, slowing down the memory timing in the BIOS's chipset setup section will help the situation, as well. Many memory modules are not suitable for high performance systems and are probably the main source of your problem.

Q: What is AGP?

A: AGP (Accelerated Graphics Port) is a new bus architecture for 3D graphics. The AGP slot eliminates the PCI bandwidth bottleneck by bypassing the PCI interface and accessing the system memory directly. Currently, the AGP supports 1X and 2X modes, which yield bandwidths of 264MB/s (at 33MHz bus speed) and 533MB/s (at 66MHz bus speed), respectively. Compare this with the mere 132MB/s (at 33MHz bus speed) that you get with the PCI bus.

Q: Does my operating system support AGP?

A: Currently, only Windows 98 and Windows NT 5.0 will have built-in support for AGP. Some AGP cards require Windows 95 OSR2.1 or a special driver from Intel. Please check with your graphics vendor for more details.

Q: Why is the S1590S motherboard NOT working on AMD K6/K6-2 300+MHz when jumper JP11 is ON?

A: On the motherboard, JP11 is a split-voltage setting. Setting the jumper OFF (open) allows for separate core and I/O voltages. Newer P55C type CPU's such as AMD K6/K6-2 require this type of setting. Setting the jumper ON (closed) gives the CPU only a single voltage control typically for older P54C type CPU's. Therefore, the motherboard will experience problems if JP11 is ON.

Q: What is JP11 used for?

A: JP11 is a split-voltage setting. You should leave the jumper CLOSED if you are using a P54C CPU (non-MMX CPU). Otherwise, you should leave the jumper OPEN if you are using a P55C CPU or AMD K6 and above.

Q: My AGP Video has an Intel i740 chipset and gives me problems when I plug it onto this motherboard, why?

A: There is a known incompatibility with the Intel i740 chipset and the VIA Apollo chipset on the motherboard. In addition, Windows NT 4.0 does not support Intel's i740 and older chipsets. Nor does it support VIA apollo chipset. Such a combination will definitely cause a conflict. One solution to this problem is to download VIA's AGP driver (AGP driver ver. 2.6 or later). Go to <http://www.via.com.tw/drivers/index.htm> to download file at VIA's website.

Q: What is "Memory Clock Speed" used for?

A: The Memory Clock Speed deals with the clock speed relationship between DIMM and CPU. If you are using an AMD CPU that runs at 100MHz-bus speed and are NOT using PC100 SDRAM, you should set the jumper to AGP clock 2-3. Otherwise, if you are using PC100 SDRAM, then you should leave the jumper at CPU clock 1-2. For all other CPU's, the jumper should be set to CPUclock 1-2.

Q: What are the x1.5 and x2 multiplier jumper settings? They are not mentioned in the manual

A: For the 1.5x jumper setting - JP8 is OFF, JP9 is OFF, and JP10 is OFF
For the 2x jumper setting - JP8 is OFF, JP9 is ON, and JP10 is OFF.

Q: What is pin#1 for J3, J4, J5, and J6?

A: Pin#1 for the all the jumpers above face towards the PCI slots.

Q: Where is pin#1 for JVBAT1?

A: Pin#1 for JVBAT1 is the one closest to the VIA MVP3 chipset.

Q: Does the motherboard support x2 AGP?

A: Yes, the S1590S Trinity 100AT supports x2 AGP.

Q: What drivers do I install from the CD-ROM provided with the Trinity S1590 Motherboard?

A: Inside the CD-ROM provided with the Trinity motherboard are Win95, Win98, and WinNT 4.0 drivers for VIA MVP3 chipset and are located in the VIA folder.

The "agpyxd" folder will install driver support for AGP video. NOTE: this driver is for Win95 users only, however, some Win98 users may need to install this driver who are having conflicts in Device Manager. There are no

drivers for WinNT 4.0

The "Bmide" folder will install driver support for VIA IDE Busmaster.

NOTE: this driver is for Win95 and WinNT 4.0 users. Win98 users normally DO NOT have to install this driver; Win98 has built in VIA IDE Bustmaster driver when installed originally. Install only if you are having conflicts or exclamation marks with Hard disk controllers in Device Manager

The "viareg" folder is for "VIA Power Management Controller" and "VIA PCI to USB Universal Host Controller". NOTE: this driver is for Win95 users. There are no drivers for WinNT 4.0. No need to install for Win98 users.

The "virq13 or virq11" folder will install "VIA PCI IRQ Routing Miniport Driver". NOTE: Enable "OnChip USB" in BIOS Chipset Features setup menu and Enable "Assign IRQ for USB" in PNP/PCP Configuration Setup menu. NOTE II: this driver is for Win95 users only, however, some Win98 users may need to install this driver who are having conflicts in Device Manager. There are no drivers for WinNT 4.0

Q: When Windows 95 restarts for the first time I get the following message: "Device IOS failed to initialize. Windows Protection Error. You must reboot your computer." How do I fix this to get into Windows 95 normally?

A: Follow the following link to download the patch file for this problem:
http://www.amd.com/products/cpg/k623d/win95_update_k6.html

Q: What is JP14 for?

A: JP14 (and JP7) are provided on some S1590 versions. The jumpers control the power supply feeding the L2 cache. The two jumpers regulate the power supply voltage in order to provide the circuitry with ~3.3V for normal operation. Basically, if you have an AT power supply, have both jumpers JP7 and JP14 CLOSED or ON. If you have an ATX power supply, have them both OPEN or OFF. **Most newer versions of the S1590S motherboard do not have Jumpers JP14 or JP7 - if so, please disregard this FAQ (the settings are preset and built-in to the motherboard).**

chapter 3

BIOS Configuration

Introduction to Setup

This manual describes the Award EliteBIOS Setup program. The Setup program lets you modify basic system configuration settings. The settings are then stored in a dedicated battery-backed memory, called CMOS RAM, that retains the information when the power is turned off.

The EliteBIOS in your computer is a customized version of an industry-standard BIOS for IBM PC AT-compatible personal computers. It supports Intel x86 and compatible processors. The BIOS provides critical low-level support for the system central processing, memory, and I/O subsystems.

The EliteBIOS has been customized by adding important, but nonstandard, features such as virus and password protection, power management, and detailed fine-tuning of the chipset controlling the system. The rest of this manual is intended to guide you through the process of configuring your system using Setup.

Starting Setup

The EliteBIOS is immediately activated when you first turn on the computer. The BIOS reads system configuration information in CMOS RAM and begins

the process of checking out the system and configuring it through the power-on self test (POST).

When these preliminaries are finished, the BIOS seeks an operating system on one of the data storage devices (hard drive, floppy drive, etc.). The BIOS launches the operating system and hands control of system operations to it.

During POST, you can start the Setup program in one of two ways:

1. By pressing immediately after switching the system on, or
2. By pressing the key or by simultaneously pressing <Ctrl>, <Alt>, and <Esc> keys when the following message appears briefly at the bottom of the screen during POST:

TO ENTER SETUP BEFORE BOOT PRESS DEL KEY

If the message disappears before you respond and you still wish to enter Setup, restart the system to try again by turning it OFF then ON or pressing the RESET button on the system case. You may also restart by simultaneously pressing <Ctrl>, <Alt>, and <Delete> keys. If you do not press the keys at the correct time and the system does not boot, an error message appears and you are again asked to

PRESS F1 TO CONTINUE, DEL TO ENTER SETUP

Setup Keys

The table on the following page shows how to navigate in Setup using the keyboard.

Getting Help

Press F1 to pop up a small help window that describes the appropriate keys to use and the possible selections for the highlighted item. To exit the Help Window press <Esc> or the F1 key again.

In Case of Problems

If, after making and saving system changes with Setup, you discover that your computer no longer is able to boot, the EliteBIOS supports an override to the CMOS settings that resets your system to its default configuration.

| Key | Function |
|--------------------|---|
| Up arrow | Move to previous item. |
| Down arrow | Move to next item. |
| Left arrow | Move to item on the left hand. |
| Right arrow | Move to item on the right hand. |
| Esc key | Main Menu: Quit and do not save changes into CMOS RAM. Status Page Setup Menu: Exit current page and return to Main Menu. |
| PgUp key | Increase the numeric value or make changes. |
| PgDn key | Decrease the numeric value or make changes. |
| + key | Increase the numeric value or make changes. |
| - key | Decrease the numeric value or make changes. |
| F1 key | General help, only for Status Page Setup Menu and Option Page Setup Menu. |
| F2 key Shift-F2 | Change color from total 16 colors. F2 to select color forward, Shift-F2 to select color backwards. |
| F3 key | Calendar, only for Status Page Setup Menu. |
| F4 key | Reserved. |
| F5 key | Restore the previous CMOS value from CMOS, only for Option Page Setup Menu. |
| F6 key | Load the default CMOS RAM value from BIOS default table, only for Option Page Setup Menu. |
| F7 key | Load the default. |
| F8 key | Reserved. |
| F9 key | Reserved. |
| F10 key | Save all the CMOS changes, only for Main Menu. |

You can invoke this override by immediately pressing <Insert> when you restart your computer. You can restart by either using the ON/OFF switch, the RESET button or by pressing <Ctrl>, <Alt> and <Delete> at the same time.

The best advice is to alter only settings that you thoroughly understand. In particular, do not change settings in the Chipset screen without a good reason. The Chipset defaults have been carefully chosen by Award Software or your system manufacturer for the best performance and reliability. Even a seemingly small change to the Chipset setup may causing the system to become unstable.

Setup Variations

Not all systems have the same Setup. While the basic look and function of the Setup program remains the same for all systems, the appearance of your Setup screens may differ from the screens shown here. Each system design and chipset combination require custom configurations. In addition, the final appearance of the Setup program depends on your system designer. Your system designer can decide that certain items should not be available for user configuration and remove them from the Setup program.

Main Setup Menu

When you enter the EliteBIOS CMOS Setup Utility, a Main Menu, similar to the one shown below, appears on the screen. The Main Menu allows you to select from several Setup functions and two exit choices. Use the arrow keys to select among the items and press enter to accept and enter the sub-menu.

A brief description of each highlighted selection appears at the bottom of the screen. Following is a brief summary of each Setup category.

ROM PCI/ISA BIOS (2A5LET5A)
 CMOS SETUP UTILITY
 AWARD SOFTWARE, INC.

| | |
|---|------------------------|
| STANDARD CMOS SETUP | INTEGRATED PERIPHERALS |
| BIOS FEATURES SETUP | SUPERVISOR PASSWORD |
| CHIPSET FEATURES SETUP | USER PASSWORD |
| POWER MANAGEMENT SETUP | IDE HDD AUTO DETECTION |
| PNP/PCI CONFIGURATION | HDD LOW LEVEL FORMAT |
| LOAD BIOS DEFAULTS | SAVE & EXIT SETUP |
| LOAD SETUP DEFAULTS | EXIT WITHOUT SAVING |
| Esc : Quit F10 : Save & Exit Setup | |
| ↑ ↓ → ← : Select Item (Shift)F2 : Change Color | |
| Time, Date, Hard Disk Type ... | |

Standard CMOS Setup

Options in the original PC AT-compatible BIOS.

BIOS Features Setup

Award Software enhanced BIOS options.

Chipset Features Setup

Options specific to your system chipset.

Power Management Setup

Advanced Power Management (APM) options.

PnP/PCI Configuration

Plug and Play standard and PCI Local Bus configuration options.

Integrated Peripherals

I/O subsystems that depend on the integrated peripherals controller in your system.

Supervisor/User Password

Change, set, or disable a password. In BIOS versions that allow separate user and supervisor passwords, only the supervisor password permits access to Setup. The user password generally allows only power-on access.

IDE HDD Auto Detection

Automatically detect and configure IDE hard disk parameters.

HDD Low Level Format

A utility for formatting hard disks..

Load BIOS Defaults

BIOS defaults are factory settings for the most stable, minimal-performance system operations.

Load Setup Defaults

Setup defaults are factory settings for optimal-performance system operations.

Save & Exit Setup

Save settings in nonvolatile CMOS RAM and exit Setup.

Exit Without Saving

Abandon all changes and exit Setup.

Standard CMOS Setup

In the Standard CMOS menu you can set the system clock and calendar, record disk drive parameters and the video subsystem type, and select the type of errors that stop the BIOS POST.

ROM PCI/ISA BIOS (2A5LET59)
STANDARD CMOS SETUP
AWARD SOFTWARE, INC.

| Date (mm:dd:yy) : Fri, Jul 10 1998 | | | | | | | | | | |
|------------------------------------|---|------------------|-----------|------|--|--------------|-----------|--------|------|--------|
| Time (hh:mm:ss) : 10 : 7 : 7 | | | | | | | | | | |
| HARD DISKS | | TYPE | SIZE | CYLS | HEAD | PRECOMP | LANDZ | SECTOR | MODE | |
| Primary Master | : | Auto | 0 | 0 | 0 | 0 | 0 | 0 | AUTO | |
| Primary Slave | : | Auto | 0 | 0 | 0 | 0 | 0 | 0 | AUTO | |
| Secondary Master | : | Auto | 0 | 0 | 0 | 0 | 0 | 0 | AUTO | |
| Secondary Slave | : | Auto | 0 | 0 | 0 | 0 | 0 | 0 | AUTO | |
| Drive A | : | 1.44M, 3.5 in. | | | | | | | | |
| Drive B | : | None | | | | | | | | |
| Video | : | EGA/VGA | | | | | | | | |
| Halt On | : | All But Keyboard | | | | | | | | |
| | | | | | Base Memory: 640K Extended Memory: 130048K Other Memory: 384K <hr/> Total Memory: 131072K | | | | | |
| ESC | : | Quit | ↑ ↓ → ← | | : | Select Item | PU/PD/+/- | | : | Modify |
| F1 | : | Help | (Shift)F2 | | : | Change Color | | | | |

BIOS

Date

The BIOS determines the day of the week from the other date information. This field is for information only. Press the arrow keys to move to the desired field (date, month, year). Press the PgUp or PgDn key to increment the setting, or type the desired value into the field.

Time

The time format is based on the 24-hour military-time clock. For example, 1 p.m. is 13:00:00. Press the arrow keys to move to the desired field. Press the PgUp or PgDn key to increment the setting, or type the desired value into the field.

HARD DISKS

The BIOS supports up to four IDE drives. This section does not show information about other IDE devices, such as a CD-ROM drive, or about other hard drive types, such as SCSI drives. Note: We recommend that you select type auto for all drives.

The BIOS can automatically detect the specifications and optimal operating mode of almost all IDE hard drives. When you select type auto for a hard drive, the BIOS detects its specifications during POST, every time the system boots. If you do not want to select drive type auto, other methods of selecting the drive type are available:

1. Match the specifications of your installed IDE hard drive(s) with the preprogrammed values for drive types 1 through 45.
2. Select User and enter values into each drive parameter field.
3. Use the IDE HDD Auto Detection function in Setup.

Here is a brief explanation of drive specifications:

Type: The BIOS contains a table of pre-defined drive types. Each defined drive type has a specified number of cylinders, number of heads, write precompensation factor, landing zone, and number of sectors. Drives whose specifications do not accommodate any pre-defined type are classified as type user.

Size: Disk drive capacity (approximate). Note that this size is usually slightly greater than the size of a formatted disk given by a disk-checking program.

Cyls: Number of cylinders

Head: Number of heads

Precomp: Write precompensation cylinder

Landz: Landing zone

Sector: Number of sectors

Mode: Auto, Normal, large, or LBA

Auto: The BIOS automatically determines the optimal mode.

Normal: Maximum number of cylinders, heads, and sectors supported are 1024, 16, and 63.

Large: For drives that do not support LBA and have more than 1024 cylinders.

LBA (Logical Block Addressing): During drive accesses, the IDE controller transforms the data address described by sector, head, and cylinder number into a physical block address, significantly improving data transfer rates. For drives with greater than 1024 cylinders.

Drive A, Drive B

Select the correct specifications for the diskette drive(s) installed in the computer.

| | |
|---------------|--|
| None | No diskette drive installed |
| 360K, 5.25 in | 5-1/4 inch PC-type standard drive; 360 kilobyte capacity |
| 1.2M, 5.25 in | 5-1/4 inch AT-type high-density drive; 1.2 megabyte capacity |
| 720K, 3.5 in | 3-1/2 inch double-sided drive; 720 kilobyte capacity |
| 1.44M, 3.5 in | 3-1/2 inch double-sided drive; 1.44 megabyte capacity |
| 2.88M, 3.5 in | 3-1/2 inch double-sided drive; 2.88 megabyte capacity |

Video

Select the type of primary video subsystem in your computer. The BIOS usually detects the correct video type automatically. The BIOS supports a secondary video subsystem, but you do not select it in Setup.

| | |
|---------|--|
| EGA/VGA | Enhanced Graphics Adapter/Video Graphics Array. For EGA, VGA, SEGA, SVGA, or PGA monitor adapters. |
| CGA 40 | Color Graphics Adapter, power up in 40 column mode. |
| CGA 80 | Color Graphics Adapter, power up in 80 column mode. |
| MONO | Monochrome adapter, includes high resolution monochrome adapters. |

Halt On

During the power-on self-test (POST), the computer stops if the BIOS detects a hardware error. You can tell the BIOS to ignore certain errors during POST and continue the boot-up process. These are the selections:

| | |
|-------------------|--|
| No errors | POST does not stop for any errors. |
| All errors | If the BIOS detects any non-fatal error, POST stops and prompts you to take corrective action. |
| All, But Keyboard | POST does not stop for a keyboard error, but stops for all other errors. |
| All, But Diskette | POST does not stop for diskette drive errors, but stops for all other errors. |
| All, But Disk/Key | POST does not stop for a keyboard or disk error, but stops for all other errors. |

Memory

You cannot change any values in the Memory fields; they are only for your information. The fields show the total installed random access memory (RAM) and amounts allocated to base memory, extended memory, and other (high) memory. RAM is counted in kilobytes (KB: approximately one thousand bytes) and megabytes (MB: approximately one million bytes).

RAM is the computer's working memory, where the computer stores programs and data currently being used, so they are accessible to the CPU. Modern personal computers may contain up to 64 MB, 128 MB, or more.

Base Memory: Typically 640 KB. Also called conventional memory. The DOS operating system and conventional applications use this area.

Extended Memory: Above the 1-MB boundary. Early IBM personal computers could not use memory above 1 MB, but current PCs and their software can use extended memory.

Other Memory: Between 640 KB and 1 MB; often called high memory. DOS may load terminate-and-stay-resident (TSR) programs, such as device drivers, in this area, to free as much conventional memory as possible for applications. Lines in your config.sys file that start with loadhigh load programs into high memory.

BIOS Features Setup

The screen (shown on the following page) contains industry-standard options additional to the core PC AT BIOS. This section describes all fields offered by Award Software in this screen. The example screen below may vary from the one in your Setup program. Your system board designer may omit or modify some fields.

ROM PCI/ISA BIOS (2A5LET59)
 BIOS FEATURES SETUP
 AWARD SOFTWARE, INC.

| | |
|---|---|
| Virus Warning : Disabled CPU Internal Cache : Enabled External Cache : Enabled Quick Power On Self Test : Disabled Boot Sequence : A, C, SCSI Swap Floppy Drive : Disabled Boot Up Floppy Seek : Enabled Boot Up NumLock Status : On Boot Up System Speed : High Gate A20 Option : Normal Memory Parity/ECC Check : Disabled Typematic Rate Setting : Disabled Typematic Rate (Chars/Sec) : 6 Typematic Delay (Msec) : 250 Security Option : Setup PCI/VGA Palette Snoop : Disabled OS Select For DRAM > 64MB : Non-OS2 | Video BIOS Shadow : Enabled C8000-CBFFF Shadow : Disabled CC000-CFFFF Shadow : Disabled D0000-D3FFF Shadow : Disabled D4000-D7FFF Shadow : Disabled D8000-DBFFF Shadow : Disabled DC000-DFFFF Shadow : Disabled |
| ESC : Quit ↑↓→← : Select Item F1 : Help PU/PD/+/- : Modify F5 : Old Values (Shift)F2 : Color F6 : Load BIOS Defaults F7 : Load Setup Defaults | |

BIOS

BIOS Feature Setup - Default Settings Chart

| Setting Option | BIOS Default | Setup Default |
|----------------------------|--------------|---------------|
| Virus Warning | Disabled | Disabled |
| CPU Internal Cache | Enabled | Enabled |
| External Cache | Enabled | Enabled |
| Quick Power On Self Test | Disabled | Enabled |
| Boot Sequence | A,C, SCSI | A,C, SCSI |
| Swap Floppy Drive | Disabled | Disabled |
| Boot Up Floppy Seek | Enabled | Enabled |
| Boot Up NumLock Status | On | On |
| Boot Up System Speed | High | High |
| Gate A20 Option | Normal | Fast |
| Memory Parity / ECC Check | Disabled | Disabled |
| Typematic Rate Setting | Disabled | Disabled |
| Typematic Rate (Chars/Sec) | 6 | 6 |
| Typematic Delay (Msec) | 250 | 250 |
| Security Option | Setup | Setup |
| PCI / VGA Palette Snoop | Disabled | Disabled |
| OS Select For DRAM > 64MB | Non-OS2 | Non-OS2 |
| Video BIOS Shadow | Enabled | Enabled |
| C8000-CBFFF Shadow | Disabled | Disabled |
| CC000-CFFFF Shadow | Disabled | Disabled |
| D0000-D3FFF Shadow | Disabled | Disabled |

Settings Chart (Continued)

| Setting Option | BIOS Default | Setup Default |
|--------------------|--------------|---------------|
| D4000-D7FFF Shadow | Disabled | Disabled |
| D8000-DBFFF Shadow | Disabled | Disabled |
| DC000-DFFFF Shadow | Disabled | Disabled |

Virus Warning

When enabled, you receive a warning message if a program (specifically, a virus) attempts to write to the boot sector or the partition table of the hard disk drive. You should then run an anti-virus program. Keep in mind that this feature protects only the boot sector, not the entire hard drive. Note: Many disk diagnostic programs that access the boot sector table can trigger the virus warning message. If you plan to run such a program, we recommend that you first disable the virus warning.

CPU Internal Cache/External Cache

Cache memory is additional memory that is much faster than conventional DRAM (system memory). CPUs from 486-type on up contain internal cache memory, and most, but not all, modern PCs have additional (external) cache memory. When the CPU requests data, the system transfers the requested data from the main DRAM into cache memory, for even faster access by the CPU. The External Cache field may not appear if your system does not have external cache memory.

Quick Power On Self Test

Select Enabled to reduce the amount of time required to run the power-on self-test (POST). A quick POST skips certain steps. We recommend that you normally disable quick POST. Better to find a problem during POST than lose data during your work.

Boot Sequence

The original IBM PCs loaded the operating system from drive A (floppy disk), so IBM PC-compatible systems are designed to search for an operating system first on drive A, and then on drive C (hard disk). However, modern computers usually load the operating system from the hard drive, and may even load it from a CD-ROM drive. The BIOS now offers a large number of boot devices and boot sequence options.

Swap Floppy Drive

This field is effective only in systems with two floppy drives. Selecting

Enabled assigns physical drive B to logical drive A, and physical drive A to logical drive B.

Boot Up Floppy Seek

When Enabled, the BIOS tests (seeks) floppy drives to determine whether they have 40 or 80 tracks. Only 360-KB floppy drives have 40 tracks; drives with 720 KB, 1.2 MB, and 1.44 MB capacity all have 80 tracks. Because very few modern PCs have 40-track floppy drives, we recommend that you set this field to Disabled to save time.

Boot Up NumLock Status

Toggle between On or Off to control the state of the NumLock key when the system boots. When toggled On, the numeric keypad generates numbers instead of controlling cursor operations.

Boot Up System Speed

Select High to boot at the default CPU speed; select Low to boot at the speed of the AT bus. Some add-in peripherals or old software (such as old games) may require a slow CPU speed. The default setting is High.

Gate A20 Option

Gate A20 refers to the way the system addresses memory above 1 MB (extended memory). When set to Fast, the system chipset controls Gate A20. When set to Normal, a pin in the keyboard controller controls Gate A20. Setting Gate A20 to Fast improves system speed, particularly with OS/2 and Windows.

Memory Parity/ECC Check

Select Enabled or Disabled. If Enabled, allows memory checking when the BIOS detects the presence of ECC or Parity DRAM.

Typematic Rate Setting

When Disabled, the following two items (Typematic Rate and Typematic Delay) are irrelevant. Keystrokes repeat at a rate determined by the keyboard controller in your system. When Enabled, you can select a typematic rate and typematic delay.

Typematic Rate (Chars/Sec)

When the typematic rate setting is enabled, you can select a typematic rate (the rate at which character repeats when you hold down a key) of 6, 8, 10, 12, 15, 20, 24 or 30 characters per second.

Typematic Delay (Msec)

When the typematic rate setting is enabled, you can select a typematic delay (the delay before key strokes begin to repeat) of 250, 500, 750 or 1000 milliseconds.

Security Option

If you have set a password, select whether the password is required every time the System boots, or only when you enter Setup.

PCI/VGA Palette Snoop

Your BIOS Setup may not contain this field. If the field is present, leave at Disabled.

OS Select for DRAM > 64MB

Select OS2 only if you are running OS/2 operating system with greater than 64 MB of RAM on your system.

Video BIOS Shadow

Software that resides in a read-only memory (ROM) chip on a device is called firmware. The EliteBIOS permits shadowing of firmware such as the system BIOS, video BIOS, and similar operating instructions that come with some expansion peripherals, such as, for example, a SCSI adaptor.

Shadowing copies firmware from ROM into system RAM, where the CPU can read it through the 16-bit or 32-bit DRAM bus. Firmware not shadowed must be read by the system through the 8-bit X-bus. Shadowing improves the performance of the system BIOS and similar ROM firmware for expansion peripherals, but it also reduces the amount of high memory (640 KB to 1 MB) available for loading device drivers, etc.

Enable shadowing into each section of memory separately. Many system designers hardwire shadowing of the system BIOS and eliminate a System BIOS Shadow option.

Video BIOS shadows into memory area C0000-C7FFF. The remaining areas shown on the BIOS Features Setup screen may be occupied by other expansion card firmware. If an expansion peripheral in your system contains ROM-based firmware, you need to know the address range the ROM occupies to shadow it into the correct area of RAM.

Chipset Features Setup

This section describes features of the Intel 440EX chipset.

Advanced Options

The parameters in this screen are for system designers, service personnel, and technically competent users only. Do not reset these values unless you understand the consequences of your changes. Note: This chapter describes all fields offered by Award Software in this screen. Your system board designer may omit or modify some fields.

ROM PCI/ISA BIOS (2A5LET59)
 CHIPSET FEATURES SETUP
 AWARD SOFTWARE, INC.

BIOS

| | |
|---|--|
| Bank 0/1 DRAM Timing : FP/EDO 70ns Bank 2/3 DRAM Timing : FP/EDO 70ns Bank 4/5 DRAM Timing : SDRAM 10ns SDRAM Cycle Length : 3 DRAM Read Pipeline : Disabled Cache Rd+CPU Wt Pipeline : Disabled Cache Timing : Fast Video BIOS Cacheable : Disabled System BIOS Cacheable : Disabled Memory Hole At 15Mb Addr : Disabled AGP Aperture Size : 64M CPU Fan On/Off On Suspend : ON | OnChip USB : Disabled CPU Warning Temperature : Disabled Current CPU Temperature : 61C/141F Current CPUFAN1 Speed : 0RPM Current CPUFAN2 Speed : 0RPM Current Vin3(V) : 2.45V |
| ESC : Quit ↑↓→← : Select Item F1 : Help PU/PD/+/- : Modify F5 : Old Values (Shift)F2 : Color F6 : Load BIOS Defaults F7 : Load Setup Defaults | |

Chipset Features Setup - Default Settings Chart

| Setting Option | BIOS Default | Setup Default |
|---------------------------|--------------|---------------|
| Bank 0/1 DRAM Timing | FP/EDO 70ns | FP/EDO 60ns |
| Bank 2/3 DRAM Timing | FP/EDO 70ns | FP/EDO 60ns |
| Bank 4/5 DRAM Timing | SDRAM 10ns | SDRAM 8ns |
| SDRAM Cycle Length | 3 | 3 |
| DRAM Read Pipeline | Disabled | Enabled |
| Cache Rd+CPU Wt Pipeline | Disabled | Enabled |
| Cache Timing | Fast | Fast |
| Video BIOS Cacheable | Enabled | Enabled |
| System BIOS Cacheable | Enabled | Enabled |
| Memory Hole At 15Mb Addr | Disabled | Disabled |
| AGP Aperture Size | 64M | 64M |
| CPU Fan On/Off On Suspend | On | On |
| OnChip USB | Disabled | Disabled |
| CPU Warning Temperature | Disabled | 70C / 158F |

Bank 0/1, 2/3, 4/5 DRAM Timing

The system board designer must select the proper value for these fields, according to the specifications of the installed DRAM chips. Turbo mode reduces CAS access time by 1 clock tick.

SDRAM Cycle Length

This field sets the CAS latency timing.

DRAM Read Pipeline

Select Enabled to pipeline reads from system memory. Pipelining improves system performance.

Cache Rd+CPU Wt Pipeline

Select Enabled to pipeline reads from cache memory and writes from the CPU. Pipelining improves system performance.

Cache Timing

For a secondary cache of one bank, select Faster. For a secondary cache of two banks, select Fastest.

Video BIOS Cacheable

Selecting Enabled allows caching of the video BIOS ROM at C0000h to C7FFFh, resulting in better video performance. However, if any program writes

to this memory area, a memory access error may result in a system error.

System BIOS Cacheable

If Enabled, results in better system performance by permitting caching of the system BIOS ROM at F0000h-FFFFFh. Any program which tries to write to this memory area, however, may cause a system error.

Memory Hole at 15Mb Addr.

You can reserve this area of system memory for ISA adapter ROM. When this area is reserved, it cannot be cached. The user information of peripherals that need to use this area of system memory usually discusses their memory requirements.

AGP Aperture Size

Select the size of the Accelerated Graphics Port (AGP) aperture. The aperture is a portion of the PCI memory address range dedicated for graphics memory address space. Host cycles that hit the aperture range are forwarded to the AGP without any translation. See www.agpforum.org for AGP information.

CPU Fan On/Off On Suspend

This option allows for the CPU Fan to remain On or to be off while in suspend mode.

SDRAM RAS to CAS Delay

This field lets you insert a timing delay between the CAS and RAS strobe signals, used when DRAM is written to, read from, or refreshed. Fast gives faster performance; and Slow gives more stable performance. This field applies only when synchronous DRAM is installed in the system.

OnChip USB

The chipset contains an integrated USB controller. Select Enabled if you have USB peripherals.

Power Management Setup

Note: This chapter describes all fields offered by Award Software in this screen. Your system board designer may omit or modify some fields.

ROM PCI/ISA BIOS (2A5LET5A)
POWER MANAGEMENT SETUP
AWARD SOFTWARE, INC.

| | | | |
|--------------------|------------------|-----------------------------------|-------------|
| ACPI Function | : Disabled | Primary INTR | : ON |
| Power Management | : User Define | IRQ3(COM2) | : Primary |
| PM Control by APM | : No | IRQ4(COM1) | : Primary |
| Video Off Option | : Suspend->Off | IRQ5(LPT2) | : Primary |
| Video Off Method | : V/H SYNC+Blank | IRQ6(Floppy Disk) | : Primary |
| MODEM Use IRQ | : 3 | IRQ7(LPT1) | : Primary |
| Soft-Off by PWRBTN | : Delay 4 sec. | IRQ8(RTC Alarm) | : Disabled |
| ** PM Timers ** | | IRQ9(IRQ2 Redir) | : Secondary |
| HDD Power Down | : Disabled | IRQ10(Reserved) | : Secondary |
| Doze Mode | : Disabled | IRQ11(Reserved) | : Secondary |
| Suspend Mode | : Disabled | IRQ12(PS/2 Mouse) | : Primary |
| ** PM Events ** | | IRQ13(Coprocessor) | : Disabled |
| VGA | : OFF | IRQ14(Hard Disk) | : Primary |
| LPT & COM | : LPT/COM | IRQ15(Reserved) | : Disabled |
| HDD & FDD | : ON | | |
| DMA/master | : OFF | | |
| Modem Ring Resume | : Disabled | ESC : Quit ↑↓→← : Select Item | |
| RTC Alarm Resume | : Disabled | F1 : Help PU/PD/+/- : Modify | |
| | | F5 : Old Values (Shift)F2 : Color | |
| | | F6 : Load BIOS Defaults | |
| | | F7 : Load Setup Defaults | |

Power Management Setup - Default Settings Chart

| Setting Option | BIOS Default | Setup Default |
|--------------------|-----------------|----------------|
| ACPI Function | Disabled | Disabled |
| Power Management | User Define | User Define |
| PM Control by APM | No | No |
| Video Off Option | Suspend -> Off | Suspend -> Off |
| Video Off Method | V/ H SYNC+Blank | DPMS Support |
| MODEM Use IRQ | 3 | 3 |
| Soft-Off by PWRBTN | Delay 4 sec. | Instant Off |
| HDD Power Down | Disabled | Disabled |
| Doze Mode | Disabled | Disabled |
| Suspend Mode | Disabled | Disabled |
| VGA | OFF | OFF |
| LPT & COM | LPT / COM | LPT / COM |
| HDD & FDD | ON | ON |
| DMA/master | OFF | OFF |

Settings Chart (Continued)

| Setting Option | BIOS Default | Setup Default |
|---------------------|--------------|---------------|
| Modem Ring Resume | Disabled | Disabled |
| RTC Alarm Resume | Disabled | Disabled |
| Primary INTR | ON | ON |
| IRQ3 (COM2) | Primary | Primary |
| IRQ4 (COM1) | Primary | Primary |
| IRQ5 (LPT2) | Primary | Primary |
| IRQ6 (Floppy Disk) | Primary | Primary |
| IRQ7 (LPT1) | Primary | Primary |
| IRQ8 (RTC Alarm) | Disabled | Disabled |
| IRQ9 (IRQ2 Redir) | Secondary | Secondary |
| IRQ10 (Reserved) | Secondary | Secondary |
| IRQ11 (Reserved) | Secondary | Secondary |
| IRQ12 (PS/2 Mouse) | Primary | Primary |
| IRQ13 (Coprocessor) | Disabled | Primary |
| IRQ14 (Hard Disk) | Primary | Primary |
| IRQ15 (Reserved) | Disabled | Disabled |

ACPI Function

Enable or disable Advanced Configuration Power Interface.

Power Management

This option allows you to select the type (or degree) of power saving for Doze, Standby, and Suspend modes. See the section PM Timers for a brief description of each mode. This table describes each power management mode:

| | |
|-------------|--|
| Max saving | Maximum power savings. Only available for SL CPUs. Inactivity period is 1 minute in each mode. |
| User Define | Set each mode individually. Select time-out periods in the PM Timers section, following. |
| Min Saving | Minimum power savings. Inactivity period is 1 hour in each mode (except the hard drive). |

PM Control by APM

If Advanced Power Management (APM) is installed on your system, selecting Yes gives better power savings.

Video Off Option

Selects the power-saving modes during which the monitor goes blank.

| | |
|------------------|---|
| Always On | Monitor remains on during power-saving modes. |
| Suspend --> Off | Monitor blanked when system enters Suspend mode. |
| All Modes--> Off | Monitor blanked when system enters any power-saving mode. |

Video Off Method

Determines the manner in which the monitor is blanked. The Blank Screen option will let the system BIOS blank the screen when disabling video. V/H sync+Blank will allow the system BIOS to turn off the V-SYNC and H-SYNC signals running from the VGA card to the monitor.

| | |
|----------------|---|
| V/H SYNC+Blank | System turns off vertical and horizontal synchronization ports and writes blanks to the video buffer. |
| DPMS Support | Select this option if your monitor supports the Display Power Management Signaling (DPMS) standard of the Video Electronics Standards Association (VESA). Use the software supplied for your video subsystem to select video power management values. |
| Blank Screen | System only writes blanks to the video buffer. |

MODEM Use IRQ

If Modem Ring Resume is Enabled, it is possible to wake the system by dialing in to it. This field determines which IRQ will be monitored for the incoming call.

Soft-Off by PWRBTN

When you select Instant Off or Delay 4 Sec., turning the system off with the on/off button places the system in a very low power usage state, either immediately or after 4 seconds, with only enough circuitry receiving power to detect wake-up event activity.

**** PM Timers ****

The following modes are Green PC power saving functions that are user-configurable only in User Defined Power Management mode.

HDD Power Down

After the selected period of drive inactivity (1 to 15 minutes), the hard disk drive powers down while all other devices remain active.

Doze Mode

After the selected period of system inactivity (1 minute to 1 hour), the CPU clock runs at slower speed while all other devices still operate at full speed.

Suspend Mode

After the selected period of system inactivity (1 minute to 1 hour), all devices except the CPU shut off.

**** PM Events ****

A power management (PM) event awakens the system from, or resets activity timers for, Suspend mode. You can disable monitoring of common interrupt requests so they do not generate PM events.

VGA

When On, any video activity is a PM event.

LPT & COM

Select none, or one or more, ports whose activity is a PM event.

HDD & FDD

When On, any hard drive or floppy drive activity is a PM event.

DMA/master

When On, any DMA or bus master activity is a PM event.

Modem Ring Resume

When Enabled, an input signal on the serial Ring Indicator (RI) line (in other words, an incoming call on the modem) awakens the system from Suspend mode.

RTC Alarm Resume

When Enabled, you can set the date and time at which the RTC (real-time clock) alarm awakens the system from Suspend mode.

Primary INTR

A system peripheral signals that it wants to gain the attention of the operating system by sending an interrupt request. When the system is in Suspend mode, IRQ activity can cause a Primary or Secondary wake-up. When Primary INTR is On, the IRQs in the above fields can be configured as Primary, Secondary, or Disabled.

| | |
|-----------|--|
| Primary | The system wakes up fully when it detects IRQ activity. |
| Secondary | The system does not wake up, but the interrupt request is processed. Secondary interrupts are typically housekeeping devices needed to maintain the system while not requiring the use of the rest of the system resources. For example, IRQ8, the RTC Alarm, is configured as Secondary by default. Another example might be a network adapter continually polled by the network. |

IRQ_n

The following is a list of IRQs (Interrupt Request Lines) assigned to common system peripherals.

IRQ3 (COM2)

IRQ4 (COM1)

IRQ5 (LPT2)

IRQ6 (Floppy Disk)

IRQ7 (LPT1)

IRQ8 (RTC Alarm)

IRQ9 (IRQ2 Redir)

IRQ10 (Reserved)

IRQ11 (Reserved)

IRQ12 (PS/2 Mouse)

IRQ13 (Coprocessor)

IRQ14 (Hard Disk)

IRQ15 (Reserved)

PnP/PCI Configuration

Note: This chapter describes all fields offered by Award Software in this screen. Your system board designer may omit or modify some fields.

ROM PCI/ISA BIOS (2A5LET5A)
 PNP/PCI CONFIGURATION
 AWARD SOFTWARE, INC.

| | | | |
|--|------------|--------------------------|------------|
| PNP OS Installed | : No | CPU to PCI Write Buffer | : Enabled |
| Resources Controlled By | : Auto | PCI Dynamic Bursting | : Disabled |
| Reset Configuration Data | : Disabled | PCI Master 0 WS Write | : Enabled |
| | | PCI Delay Transaction | : Disabled |
| | | PCI Master Read Prefetch | : Disabled |
| | | PCI#2 Access #1 Retry | : Disabled |
| | | AGP Master 1 WS Write | : Disabled |
| | | AGP Master 1 WS Read | : Disabled |
| | | PCI IRQ Activated By | : Level |
| | | Assign IRQ for USB | : Enabled |
| | | Assign IRQ for VGA | : Disabled |
| <p>ESC : Quit ↑↓←→ : Select Item F1 : Help PU/PD/+/- : Modify F5 : Old Values (Shift)F2 : Color F6 : Load BIOS Defaults F7 : Load Setup Defaults</p> | | | |

BIOS

PnP/PCI Configuration - Default Settings Chart

| Setting Option | BIOS Default | Setup Default |
|--------------------------|--------------|---------------|
| PnP OS Installed | No | No |
| Resources Controlled By | Auto | Auto |
| Reset Configuration Data | Disabled | Disabled |
| CPU to PCI Write Buffer | Enabled | Enabled |
| PCI Dynamic Bursting | Disabled | Enabled |
| PCI Master 0 WS Write | Enabled | Enabled |
| PCI Delay Transaction | Disabled | Enabled |
| PCI Master Read Prefetch | Disabled | Enabled |
| PCI#2 Access #1 Retry | Disabled | Disabled |
| AGP Master 1 WS Write | Disabled | Enabled |
| AGP Master 1 WS Read | Disabled | Disabled |
| PCI IRQ Activated By | Level | Level |
| Assign IRQ for USB | Enabled | Enabled |
| Assign IRQ for VGA | Disabled | Enabled |

PNP OS Installed

Select Yes if the system operating environment is Plug-and-Play aware (e.g., Windows 95).

Resources Controlled By

The Plug and Play EliteBIOS can automatically configure all the boot and Plug and Play-compatible devices. If you select Auto, all the interrupt request (IRQ) and DMA assignment fields disappear, because the BIOS automatically assigns them.

Reset Configuration Data

Normally, you leave this field Disabled. Select Enabled to reset Extended System Configuration Data (ESCD) when you exit Setup if you have installed a new add-on and the system reconfiguration has caused such a serious conflict that the operating system cannot boot.

IRQ-*n* Assigned to

When resources are controlled manually, assign each system interrupt as one of the following types, depending on the type of device using the interrupt:

Legacy ISA: Devices compliant with the original PC AT bus specification, requiring a specific interrupt (such as IRQ4 for serial port 1).

PCI/ISA PnP: Devices compliant with the Plug and Play standard, whether designed for PCI or ISA bus architecture.

DMA-*n* Assigned to

When resources are controlled manually, assign each system DMA channel as one of the following types, depending on the type of device using the interrupt:

Legacy ISA: Devices compliant with the original PC AT bus specification, requiring a specific DMA channel

PCI/ISA PnP: Devices compliant with the Plug and Play standard, whether designed for PCI or ISA bus architecture.

CPU to PCI Write Buffer

When this field is Enabled, writes from the CPU to the PCI bus are buffered, to compensate for the speed differences between the CPU and the PCI bus.

When Disabled, the writes are not buffered and the CPU must wait until the write is complete before starting another write cycle.

PCI Dynamic Bursting

When Enabled, every write transaction goes to the write buffer. Burstable transactions then burst on the PCI bus; nonburstable transactions do not.

PCI Master 0 WS Write

When this field is Enabled, writes to the PCI bus are executed with zero wait states.

PCI Delay Transaction

The chipset has an embedded 32-bit posted write buffer to support delay transaction cycles. Select Enabled to support compliance with PCI specification version 2.1.

PCI Master Read Prefetch

A prefetch occurs during a read operations process when the controller “peeks” at the next instruction and actually begins the next read instruction. When this field is Enabled, the PCI bus master device is allowed to prefetch the next read instruction and initiate the next read operation.

PCI#2 Access #1 Retry

Select Enabled to rotate priority of PCI masters.

AGP Master 1 WS Write

Select Enabled to add one clock tick to AGP write operations.

AGP Master 1 WS Read

Select Enabled to add one clock tick to AGP read operations.

PCI IRQ Activated By

Leave the IRQ trigger set at Level unless the PCI device assigned to the interrupt specifies Edge-triggered interrupts.

Assign IRQ for USB

Assign an IRQ number to the onboard USB port.

Assign IRQ for VGA

Assign an IRQ number to your VGA adapter.

Assign IRQ for ACPI

Assign an IRQ number to ACPI.

Integrated Peripherals

Note: This chapter describes all fields offered by Award Software in this screen. Your system board designer may omit or modify some fields.

ROM PCI/ISA BIOS (2A5LET59)
INTEGRATED PERIPHERALS
AWARD SOFTWARE, INC.

| | | | |
|---------------------------|------------|---|------------|
| OnChip IDE First Channel | : Enabled | Onboard FDD Controller | : Enabled |
| OnChip IDE Second Channel | : Enabled | Onboard Serial Port 1 | : 3F8/IRQ4 |
| IDE Prefetch Mode | : Disabled | Onboard Serial Port 2 | : 2F8/IRQ3 |
| IDE HDD Block Mode | : Enabled | UART2 Mode | : Standard |
| IDE Primary Master PIO | : Auto | | |
| IDE Primary Slave PIO | : Auto | Onboard Parallel Port | : 378/IRQ7 |
| IDE Secondary Master PIO | : Auto | Onboard Parallel Mode | : SPP |
| IDE Secondary Slave PIO | : Auto | | |
| IDE Primary Master UDMA | : Disabled | | |
| IDE Primary Slave UDMA | : Disabled | | |
| IDE Secondary Master UDMA | : Disabled | | |
| IDE Secondary Slave UDMA | : Disabled | | |
| Init Display First | : PCI Slot | | |
| | | ESC : Quit ↑↓←→ : Select Item F1 : Help PU/PD/+/- : Modify F5 : Old Values (Shift)F2 : Color F6 : Load BIOS Defaults F7 : Load Setup Defaults | |

Integrated Peripherals - Default Settings Chart

| Setting Option | BIOS Default | Setup Default |
|---------------------------|--------------|---------------|
| OnChip IDE First Channel | Enabled | Enabled |
| OnChip IDE Second Channel | Enabled | Enabled |
| IDE Prefetch Mode | Disabled | Enabled |
| IDE HDD Block Mode | Enabled | Enabled |
| IDE Primary Master PIO | Auto | Auto |
| IDE Primary Slave PIO | Auto | Auto |
| IDE Secondary Master PIO | Auto | Auto |
| IDE Secondary Slave PIO | Auto | Auto |
| IDE Primary Master UDMA | Disabled | Auto |
| IDE Primary Slave UDMA | Disabled | Auto |
| IDE Secondary Master UDMA | Disabled | Auto |
| IDE Secondary Slave UDMA | Disabled | Auto |
| Init Display First | PCI Slot | AGP |
| Onboard FDD Controller | Enabled | Enabled |
| Onboard Serial Port 1 | 3F8 / IRQ4 | 3F8 / IRQ4 |

Settings Chart (Continued)

| Setting Options | BIOS Default | Setup Default |
|-----------------------|--------------|---------------|
| Onboard Serial Port 2 | 2F8 / IRQ3 | 2F8 / IRQ3 |
| UART2 Mode | Standard | Standard |
| Onboard Parallel Port | 378 / IRQ7 | 378 / IRQ7 |
| Onboard Parallel Mode | SPP | SPP |

On-Chip PCI IDE First/Second Channel

This chipset contains a PCI IDE interface with support for two IDE channels. Select Enabled to activate the primary and/or secondary onboard IDE interface. Select Disabled to deactivate this interface, if you install a primary and/or secondary add-in IDE interface.

IDE Prefetch Mode

The onboard IDE drive interface supports IDE prefetching for faster drive accesses. If you install a primary and/or secondary add-in IDE interface, set this field to Disabled if the interface does not support prefetching.

IDE HDD Block Mode

Select Enabled only if your hard drives support block mode. Most new drives support block mode. If Enabled, block mode yields automatic detection of the optimal number of block read/writes per sector that the drive can support.

IDE Primary/Secondary Master/Slave PIO

The four IDE PIO (Programmed Input/Output) fields let you set a PIO mode (0-4) for each of up to four IDE devices that the internal PCI IDE interface supports. Modes 0 through 4 provide successively increased performance. In Auto mode, the system automatically determines the best mode for each device.

IDE Primary/Secondary Master/Slave UDMA

UDMA (Ultra DMA) is a DMA data transfer protocol that utilizes ATA commands and the ATA bus to allow DMA commands to transfer data at a maximum burst rate of 33 MB/s. When you select Auto in the four IDE UDMA fields (for each of up to four IDE devices that the internal PCI IDE interface supports), the system automatically determines the optimal data transfer rate for each IDE device.

Init Display First

Select the type of display adapter used in your system.

Onboard FDD Controller

Select Enabled if your system has a floppy disk controller (FDC) installed on the system board and you wish to use it. If you install an add-in FDC or the system has no floppy drive, select Disabled in this field.

Onboard Serial Port 1/2

Select a logical COM port address and corresponding interrupt for the first and second serial ports. The second serial port offers infrared options in the next field.

UART2Mode

Select an operating mode for the second serial port:

| | |
|----------|-------------------------------------|
| Standard | RS-232C serial port |
| HPSIR | IrDA compliant serial infrared port |
| ASKIR | Amplitude shift keyed infrared port |

Onboard Parallel Port

Select a logical LPT port address and corresponding interrupt for the physical parallel port.

Onboard Parallel Mode

Select a mode for the onboard parallel port.

ECPMode Use DMA

Select a DMA channel for the parallel port for use during ECP mode.

Parallel Port EPPType

Select EPP port type 1.7 or 1.9. Your device's user information should tell you which port type is required. EPP1.9 is common in newer devices.

User Password

When you select this function, a message appears at the center of the screen:

ENTER PASSWORD:

Type the password, up to eight characters, and press Enter. Typing a password clears any previously entered password from CMOS memory. Now the message changes:

CONFIRM PASSWORD:

Again, type the password and press Enter. To abort the process at any time, press Esc.

In the Security Option item in the BIOS Features Setup screen, select System or Setup:

| | |
|--------|---|
| System | Enter a password each time the system boots and whenever you enter Setup. |
| Setup | Enter a password whenever you enter Setup. |

Note: To clear the password, simply press Enter when asked to enter a password. Then the password function is disabled.

BIOS

Flash Writer Utility

You can upgrade the BIOS on your motherboard by using the Flash Memory Writer (FMW) utility. This utility can be downloaded from TYAN’s BBS and from the TYAN website. The system BIOS is stored on a flash EEPROM chip on the mainboard, which can be erased and reprogrammed by the FMW. The following three files make up the FMW:

- AWDFLASH.EXE The Flash Memory Writer utility for Award to Award upgrade.
- README.TXT A text file of instructions.
- S71AWXX.BIN* The new BIOS file.

(*This file name is subject to change and can have either a .bin or .rom extension.)

The FMW records (or programs) a new BIOS onto the flash memory chip. You cannot upgrade an Award BIOS to an AMI BIOS or vice-versa.

Note: You should always clear your CMOS after flashing a BIOS. This will clear out any stray settings from your old BIOS which may have been carried over from the flashing process. Most problems encountered after flashing a BIOS

will be solved by this simple procedure (see Hardware CMOS & Password Reset, page 33).

To reprogram the system BIOS, the CPU must be running in real mode. FMW will not run if the CPU is operating in a protected or virtual mode. This means that you cannot run it with Windows running or with any memory manager software. You must disable any memory manager software before you can run FMW. The easiest way to do this is as follows:

1) Boot your system from a bootable floppy disk with no CONFIG.SYS or AUTOEXEC.BAT files, and then run FMW from a backup copy of your support disk. You can make your back-up floppy bootable when you format it, and use one disk for both purposes.

2) If you are using MS-DOS 6.x, you can use the feature that allows you to bypass the CONFIG.SYS and AUTOEXEC.BAT files. You can access this feature by pressing <F5> while the “Starting MS-DOS...” line is on the screen during boot-up.

If you are uncertain whether or not you have a memory manager running, try FMW. If it works, then there is no active memory manager on your system. If you see a warning message about the CPU mode, follow the above directions to get around the memory manager.

Once you have your CPU in real mode, you can run FMW. You can copy the contents of the “Flash” directory to your hard drive, or you can run the utility from a backup of the support floppy disk. Either way, make sure that the new BIOS file is in the same directory as the FMW utility.

To start FMW, change to the “Flash” directory if you are not already in it. Type “awdfash” at the DOS command line and press the <Enter> key. The FMW utility screen will appear:

| | |
|---|---------------|
| FLASH MEMORY WRITER V3.0 Copyright(C) 1993, AWARD SOFTWARE, INC. | |
| For VX/HX-2A59CT51 | Date: 4/13/98 |
| File Name to Program: | |
| Error Message: | |

BIOS

Type in the whole file name, e.g. A61AW10.BIN, and confirm that you want to program the BIOS. The utility will then “Blank,” “Erase,” and “Program” the flash memory on the mainboard with the new BIOS file. You should choose “Yes” to save the original system BIOS to a floppy diskette **before** you program the new BIOS. This leaves you with a backup of your original BIOS in case you need to re-install it. If you cannot successfully program the new BIOS file for some reason, re-install your original BIOS from the backup file. Remember, always reset the CMOS after flashing to a new BIOS (see page 33).

Warning: If you do not successfully install a complete BIOS file in the flash memory on the mainboard, your system may not be able to boot. If this happens, it will require service by your system vendor. Follow the instructions in this section precisely to avoid such an inconvenience.

chapter 4

System Resources

POST Messages

During the power-on self test (POST), the BIOS either sounds a beep code or displays a message when it detects a correctable error. Following is a list of POST messages for the ISA BIOS kernel. Specific chipset ports and BIOS extensions may include additional messages. An error message may be followed by a prompt to press F1 to continue or press DEL to enter Setup.

Beep

Currently the only beep code indicates that a video error has occurred and the BIOS cannot initialize the video screen to display any additional information. This beep code consists of a single long beep followed by two short beeps.

BIOS ROM checksum error - System halted

The checksum of the BIOS code in the BIOS chip is incorrect, indicating the BIOS code may have become corrupt. Contact your system dealer to replace the BIOS.

CMOS battery failed

CMOS battery is no longer functional. Contact your system dealer for a replacement battery.

CMOS checksum error - Defaults loaded

Checksum of CMOS is incorrect, so the system loads the default equipment configuration. A checksum error may indicate that CMOS has become corrupt. This error may have been caused by a weak battery. Check the battery and replace if necessary.

CPU at nnnn

Displays the running speed of the CPU.

Display switch is set incorrectly.

The display switch on the motherboard can be set to either monochrome or color. This message indicates the switch is set to a different setting than indicated in Setup. Determine which setting is correct, and then either turn off the system and change the jumper, or enter Setup and change the VIDEO selection.

Press ESC to skip memory test

The user may press Esc to skip the full memory test.

Floppy disk(s) fail

Cannot find or initialize the floppy drive controller or the drive. Make sure the controller is installed correctly. If no floppy drives are installed, be sure the Diskette Drive selection in Setup is set to NONE or AUTO.

HARD DISK initializing Please wait a moment...

Some hard drives require extra time to initialize.

HARDDISKINSTALLFAILURE

Cannot find or initialize the hard drive controller or the drive. Make sure the controller is installed correctly. If no hard drives are installed, be sure the Hard Drive selection in Setup is set to NONE.

Hard disk(s) diagnosis fail

The system may run specific disk diagnostic routines. This message appears if one or more hard disks return an error when the diagnostics run.

Keyboard error or no keyboard present

The keyboard cannot initialize. Make sure the keyboard is attached correctly and no keys were pressed during POST. To purposely configure the system without a keyboard, set the error halt condition in Setup to HALT ON ALL, BUT KEYBOARD. The BIOS then ignores the missing keyboard during POST.

Keyboard is locked out - Unlock the key

This message usually indicates that one or more keys have been pressed during the keyboard tests. Be sure no objects are resting on the keyboard.

Memory Test :

This message displays during a full memory test, counting down the memory areas being tested.

Memory test fail

If POST detects an error during memory testing, additional information appears giving specifics about the type and location of the memory error.

Override enabled - Defaults loaded

If the system cannot boot using the current CMOS configuration, the BIOS can override the current configuration is a set of BIOS defaults designed for the most stable, minimal-performance system operations.

Press TAB to show POST screen

System OEMs may replace the EliteBIOS POST display with their own proprietary display. Including this message in the OEM display permits the operator to switch between the OEM display and the default POST display.

Primary master hard disk fail

POST detects an error in the primary master IDE hard drive.

Primary slave hard disk fail

POST detects an error in the secondary master IDE hard drive.

Resuming from disk, Press TAB to show POST screen

The BIOS offers a save-to-disk feature for notebook computers. This message may appear when the operator re-starts the system after a save-to-disk shut-down. See the Press TAB ... message above for a description of this feature.

Secondary master hard disk fail

POST detects an error in the primary slave IDE hard drive.

This page is intentionally left blank.

Sec
POS

Appendix 1

Glossary

ACPI (Advanced Configuration and Power Interface) is a power management specification that allows the operating system to control the amount of power distributed to the computer's devices. Devices not in use can be turned off, reducing unnecessary power expenditure.

AGP (Accelerated Graphics Port) is a PCI-based interface which was designed specifically for demands of 3D graphics applications. The 32-bit AGP channel directly links the graphics controller to the main memory. While the channel runs at only 66MHz, it supports data transmission during both the rising and falling ends of the clock cycle, yielding an effective speed of 133MHz.

The **AT** was the original form factor of IBM's PC.

ATAPI (AT Attachment Packet Interface), also known as IDE or ATA, is a drive implementation that includes the disk controller on the device itself. It allows CD-ROMs and tape drives to be configured as master or slave devices, just like hard drives.

The **ATX** form factor was designed to replace the AT form factor. It improves on the AT design by rotating the board ninety degrees, so that the IDE connectors are closer to the drive bays, and the CPU is closer to the power

supply and cooling fan. The keyboard, mouse, serial, USB, and parallel ports are built in.

Bandwidth refers to carrying capacity. The greater the bandwidth, the more data the bus, phone line, or other electrical path, can carry. Greater bandwidth, then, also results in greater speed.

A **BBS (Bulletin Board System)** is a computer system with a number of modems hooked up to it which acts as a center for users to post messages and access information.

The **BIOS (Basic Input/Output System)** program resides in the ROM chip, and provides the basic instructions for controlling your computer's hardware. Both the operating system and application software use BIOS routines to ensure compatibility.

A **buffer** is a portion of RAM which is used to temporarily store data, usually from an application, though it is also used when printing, and in most keyboard drivers. The CPU can manipulate data in a buffer before copying it, all at once, to a disk drive. While this improves system performance--reading to or writing from a disk drive a single time is much faster than doing so repeatedly--there is the possibility of losing your data should the system crash. Information stored in a buffer is temporarily stored, not permanently saved.

A **bus** is a data pathway. The term is used especially to refer to the connection between the processor and system memory, and between the processor and PCI or ISA local buses.

Bus mastering allows peripheral devices and IDEs to access the system memory without going through the CPU (similar to DMA channels).

A **cache** is a temporary storage area for data that will be needed often by an application. Using a cache lowers data access times, since the needed information is stored in the SRAM instead of in the slower DRAM. Note that the cache is also much smaller than your regular memory: a typical cache size is 512KB, while you may have as much as 1GB of regular memory.

Cache size refers to the physical size of the cache onboard. This should not be confused with the cacheable area, which is the total amount of memory which can be scanned by the system in search of data to put into the cache. A typical setup would be a cache size of 512KB, and a cacheable area of 512MB. In this case, up to 512MB of the main memory onboard is capable of being

cached. However, only 512KB of this memory will be in the cache at any given moment. Any main memory above 512MB could never be cached.

Closed and open jumpers Jumpers and jumper pins are active when they are On or Closed, and inactive when they are Off or Open.

CMOS Complementary Metal-Oxide Semiconductors are chips that hold the basic start-up information for the BIOS.

The **COM port** is another name for the serial port, which is so-called because it transmits the eight bits of a byte of data along one wire, and receives data on another single wire (that is, the data is transmitted in serial form, one bit after another). Parallel ports transmit the bits of a byte on eight different wires at the same time (that is, in parallel form, eight bits at the same time).

DIMM Dual In-line Memory Modules are a faster and more capacious form of RAM than SIMMs, and do not need to be installed in pairs.

DIMM bank DIMM banks are sometimes called DIMM sockets, because the physical slot and the logical unit are the same. That is, one DIMM module fits into one DIMM socket, which is capable of acting as a memory bank.

DMA Direct Memory Access channels are similar to IRQs. DMA channels allow hardware devices (like sound cards or keyboards) to access the main memory without involving the CPU. This frees up CPU resources for other tasks. As with IRQs, it is vital that you do not double up devices on a single line. Plug and Play devices will take care of this for you.

In **Doze mode**, only the CPU's speed is slowed.

DRAM Dynamic RAM is a widely available, very affordable form of RAM which has the unfortunate tendency to lose data if it is not recharged regularly (every few milliseconds). This refresh requirement makes DRAM slower three to ten times slower than non-recharged RAM such as SRAM.

EDO RAM (Extended Data-Out RAM) speeds access to memory locations by assuming that memory addresses are static: the next time it looks for a bit of data, it will be at the same spot, or one nearby.

EEPROM Electrically Erasable Programmable ROM, also called Flash BIOS, is a ROM chip which can, unlike normal ROM, be updated. This allows you to

keep up with changes in the BIOS programs without having to buy a new chip. TYAN's BIOS updates can be found at <http://www.tyan.com/html/drivers.html>

ESCD (Extended System Configuration Data) is a format for storing information about Plug and Play devices in the system BIOS. This information helps properly configure the system each time it boots.

Firmware is low level software that controls the system hardware.

Form factor is an industry term for the size, shape, power supply type, and external connector type of the PCB (personal computer board) or motherboard. The standard form factors are the AT and ATX, although TYAN also makes some Baby-AT boards.

A **Global timer** is an onboard hardware timer, such as the Real Time Clock.

Handshaking is a form of encryption. One system, typically the server, sends an encryption scheme to another agent, typically a client. Thus, the client's data is protected during transmittal to the server.

HDD stands for **Hard Disk Drive**.

H-SYNC controls the horizontal properties of the monitor.

IC (Integrated Circuit) is the formal name for the computer chip.

IDE Integrated Device (or Drive) Electronics is a simple, self-contained hard drive interface. It can handle drives up to 8.4GB in size. Almost all IDEs sold now are in fact Enhanced IDEs (EIDEs).

IDE INT (IDE Interrupt) is a hardware interrupt signal that goes to the IDE.

I/O Input/Output is the connection between your computer and another piece of hardware (mouse, keyboard, etc.).

IRQ An Interrupt Request is an electronic request that runs from a hardware device to the CPU. The interrupt controller assigns priorities to incoming requests and delivers them to the CPU. It is important that there is only one device hooked up to each IRQ line; doubling up devices on IRQ lines can lock up your system. Happily, Plug and Play operating systems take care of these details for you.

ISA stands for **Industry Standard Architecture**. ISA is a slower 8- or 16-bit BUS (data pathway).

Latency is the amount of time that one part of a system spends waiting for another part to catch up. This is most common when the system sends data out to a peripheral device, and is waiting for the peripheral to send some data back (peripherals tend to be slower than onboard system components).

NVRAM ROM and **EEPROM** are both examples of **Non-Volatile RAM**, memory that holds its data without power. **DRAM**, in contrast, is volatile.

OEMs (**Original Equipment Manufacturers**) like Compaq or IBM package other companies' motherboards and hardware inside their case and sell them.

The **parallel port** transmits the bits of a byte on eight different wires at the same time (that is, in parallel form, eight bits at the same time).

PCI stands for **Peripheral Component Interconnect**. PCI is a 32-bit local bus (data pathway) which is faster than the ISA bus. Local buses are those which operate within a single system (as opposed to a network bus, which connects multiple systems).

The **PCI PIO** (**PCI Programmable Input/Output**) modes are the data transfer modes used by IDE drives. These modes use the CPU for data transfer (DMA channels do not). PCI refers to the type of bus used by these modes to communicate with the CPU.

PCI-to-PCI bridge allows you to connect multiple PCI devices onto one PCI slot.

Pipeline burst SRAM is a fast secondary cache. It is used as a secondary cache because SRAM is slower than SDRAM, but usually larger. Data is cached first to the faster primary cache, and then, when the primary cache is full, to the slower secondary cache.

Pipelining improves system performance by allowing the CPU to begin executing a second instruction before the first is completed. A pipeline can be likened to an assembly line, with a given part of the pipeline repeatedly executing a set part of an operation on a series of instructions.

PM timers (**Power Management timers**) are software timers that count down the number of seconds or minutes until the system times out and enters sleep,

suspend, or doze mode.

PnP is an acronym for Plug and Play, a design standard that has become ascendant in the industry. Plug and Play devices require little set-up to use. Novice end users can simply plug them into a computer that is running on a Plug and Play-aware operating system (such as Windows 95), and go to work. Devices and operating systems that are not Plug and Play require you to reconfigure your system each time you add or change any part of your hardware.

The term **RAM (Random Access Memory)**, while technically referring to a type of memory where any byte can be accessed without touching the adjacent data, is often used to refer to the system's main memory. This memory is available to any program running on the computer.

ROM (Read-Only Memory) is a storage chip which contains the BIOS (Basic Input/Output System), the basic instructions required to boot the computer and start up the operating system.

SDRAM (Synchronous Dynamic RAM) is so-called because it can keep two sets of memory addresses open simultaneously. By transferring data alternately from one set of addresses, and then the other, SDRAM cuts down on the delays associated with non-synchronous RAM, which must close one address bank before opening the next.

The **serial port** is so called because it transmits the eight bits of a byte of data along one wire, and receives data on another single wire (that is, the data is transmitted in serial form, one bit after another).

SIMM Single In-line Memory Modules are the most common form of RAM. They must be installed in pairs, and do not have the carrying capacity or the speed of DIMMs.

SIMM bank/socket SIMM sockets are the physical slots into which you stick SIMM modules. A pair of SIMM sockets form a SIMM bank, and act as a unit. If only one socket is filled, the bank will not operate.

In **Sleep/Suspend mode**, all devices except the CPU shut down.

SRAM Static RAM, unlike DRAM, does not need to be refreshed in order to prevent data loss. Thus, it is faster, and more expensive.

In **Standby mode**, the video and fixed disk drive shut down; all other devices operate normally.

UltraDMA/33 is a fast version of the old DMA channel. UltraDMA is also called UltraATA. Without UltraDMA your system cannot take advantage of the higher data transmission rates of the new UltraATA hard drives.

Universal Serial Bus or USB, is a versatile port. This one port type can function as a serial, parallel, mouse, keyboard, or joystick port. It is fast enough to support video transfer, and is capable of supporting up to 127 daisy-chained peripheral devices.

VGA (Video Graphics Array) is the PC video display standard.

V-SYNC controls the vertical properties of the monitor.

ZIF socket **Z**ero **I**nsertion **F**orce sockets make it possible to insert CPUs without damaging the sensitive pins. The CPU is lightly placed in an open ZIF socket, and the metal lever pulled down. This shifts the processor over and down, guiding it into place on the board.

Notice for the USA

Compliance Information Statement (Declaration of Conformity Procedure) DoC FCC Part 15: This Device complies with Part 15 of the FCC Rules.

Operation is subject to the following conditions:

1) this device may not cause harmful interference, and
2) this device must accept any interference received including interference that may cause undesired operation. If this equipment does cause harmful interference to radio or television reception, which can be determined by turning the equipment off and on, the user is encouraged to try one or more of the following measures:

- Reorient or relocate the receiving antenna.
- Increase the separation between the equipment and receiver.
- Plug the equipment into an outlet on a circuit different from that of the receiver.
- Consult the dealer or an experienced radio/television technician for help.

CAUTION: LITHIUM BATTERIES included with This PC board. Danger of explosion if battery is incorrectly replaced. Replace **ONLY** with the same or equivalent type recommended by manufacturer. Dispose of used batteries according to manufacturer instructions.

Notice for Canada

This apparatus complies with the Class B limits for radio interference as specified in the Canadian Department of Communications Radio Interference Regulations.

Cet appareil est conforme aux normes de Classe B d'interférence radio tel que spécifié par le Ministère Canadien des Communications dans les règlements d'interférence radio.

Notice for Europe (CE Mark)

This product is in conformity with the Council Directive 89/336/EEC, 92/31/EEC (EMC).