

CI5TTP

Half-Size Pentium PCI/ISA CPU Card

Industrial CPU Card

PC-Based Computer Boards for Industrial Automation

User's Manual

Version 1.0B

Copyright Notice

This publication is protected by copyright and all rights are reserved. No part of it may be reproduced or transmitted by any means or in any form, without prior consent of the original manufacturer.

The information in this document has been carefully checked and is believed to be accurate. However, the original manufacturer assumes no responsibility for any inaccuracies that may appear in this manual. In no event will the original manufacturer be liable for direct, indirect, special, exemplary, incidental, incidental or consequential damages resulting from any defect or omission in this manual, even if advised of possibility of such damages. The material contained herein is for informational purposes only.

Acknowledgments

AMD is a registered trademark of Advanced Micro Devices, Inc.

Award is a registered trademark of Award Software International, Inc.

C&T is a trademark of Chips and Technologies, Inc.

Cyrix is a trademark of Cyrix Corporation.

IBM, PC/AT, PS/2 are trademarks of International Business Machines Corporation.

Intel, Pentium and LANDesk are registered trademarks of Intel Corporation.

Microsoft Windows is a registered trademark of Microsoft Corporation.

Winbond is a registered trademark of Winbond Electronics Corporation.

LANDesk is a registered trademark of Intel Corporation.

All other product names or trademarks are properties of their respective owners.

CI5TTP Series Comparison Table

Model	CI5TTP	CI5TTPX
Processor	Intel Pentium (P54C, P55C/MMX) Cyrix 6x86, 6x86L, 6x86MX AMD K5, K6	Intel Pentium (P54C, P55C/MMX) Cyrix 6x86, 6x86L, 6x86MX AMD K5, K6
Processor Socket	PGA Socket	PGA Socket
Chipset	Intel 430TX	Intel 430TX
Multi I/O Chip	Winbond 83977TF	Winbond 83977TF
BIOS	Award	Award
L2 cache	512KB P.B. SRAM	512KB P.B. SRAM
Max. RAM	128MB FPM/EDO	128MB FPM/EDO
Memory Sockets	2 X 72-pin SIMM	2 X 72-pin SIMM
VGA CRT/LCD	C&T 65550	None
Watchdog Timer	16-level	16-level
PC/104 Connector	yes	yes
Enhanced IDE	yes	yes
2S/1P	yes	yes
USB	yes	yes
IrDA	yes	yes
Winbond W83781D Hardware Monitor IC	Yes	Yes
Board Size	185mm x 129mm	185mm x 129mm

Contents

Chapter 1 Introduction	1
Checklist	2
Description	2
Features	3
Specifications	3
Intelligence	5
Board Layout and Dimensions	6
Chapter 2 Installations	7
CPU Installation	8
Memory Installation	9
Jumpers on the CI5TTP	10
Jumper Locations on the CI5TTP	11
SW1 (1-4): CPU Frequency Selector	12
JP2, SW2 (1-4): CPU Voltage Selector	15
JP5: Clear CMOS Content	17
J17: External Battery Connector	17
JPW7: RS232/422/485 (COM2) Selection	18
JP9: DiskOnChip BIOS Expansion Address Select	18
Connectors on the CI5TTP	20
Connector Locations on the CI5TTP	21
J1: Chassis Fan Power Connector	22
JW1: IrDA Connector	22
JW2: Parallel Port Connector	22
JW3: AT Keyboard	23
JW4: PS/2 Mouse Connector	23
JW5: External Keyboard Connector	23
J5: LCD Panel Interface Selection	23
J6: Floppy Drive Connector	24
J8, J9: Serial Ports	24
J11, J12: USB Connectors	25
J13, J14: EIDE Connectors	26
J15: Front Bezel Connector	27
J18: CPU Fan Power Connector	29
J19: External ATX Power Connector	29
J20: LCD Panel Connector	30
Flat Panel Display Interface Pin Descriptions	31
J21: VGA CRT Connector	32
P1: Power Connector	32

CON1, CON2: PC-104 Connector	33
Watchdog Timer Configuration.....	34
Chapter 3 BIOS Configuration	35
BIOS Introduction	38
BIOS Setup.....	38
Standard CMOS Setup	39
BIOS Features Setup	43
Chipset Features Setup	46
Power Management Setup	48
PNP/PCI Configuration.....	51
Load BIOS Defaults	53
Load Setup Defaults	53
Integrated Peripherals.....	54
Supervisor / User Password.....	56
IDE HDD Auto Detection	57
HDD Low Level Format.....	57
Save & Exit Setup	58
Exit Without Saving	58
Chapter 4 VGA Driver Installation.....	59
Installing the Drivers for Windows 3.1	60
Installing the Drivers for Windows 95	61
Installing the Drivers for Windows NT 3.5x.....	62
Installing the Drivers for Windows NT 4.0.....	63
Chapter 5 Intel PIIX Bus Master IDE Driver Installation	65
Chapter 6 System Monitor User's Guide.....	69
Chapter 7 LANDesk User's Guide	77
Appendix	85
A. I/O Port Address Map.....	86
B. Interrupt Request Lines (IRQ).....	87

1

Introduction

This manual is designed to give you information on the CI5TTP CPU card. It is divided into the following sections:

- Checklist 2
- Description 2
- Features 3
- Specifications 3
- Intelligence 5
- Board Layout and Dimensions 6

Checklist

Please check that your package is complete and contains the items below. If you discover damaged or missing items, please contact your dealer.

- The CI5TTP Industrial CPU Card
- This User's Manual
- 1 IDE Ribbon Cable
- 1 Floppy Ribbon Connector
- 1 Serial Port Ribbon Cable and 1 Parallel Port Attached to a Mounting Bracket
- 1 Diskette Containing Intel PCI IDE Driver and Flash Memory Utility
- 1 Diskette Containing C&T 65550 VGA Driver
- 1 CD Containing System Monitor utility or LANdesk Client Manager (LDCM)

Description

The CI5TTP is a half-sized PCI/ISA Pentium industrial CPU card based on Intel's 430TX chipset and is fully designed for harsh industrial environment. It features a PGA socket compatible with various processors from Intel, AMD and Cyrix. This card accommodates up to 128MB of DRAMs in FPM or EDO configurations and a secondary level 512KB cache.

The CI5TTP comes with onboard CPU temperature sensor to protect your processor from overheating. The power management feature provides power savings by slowing down the CPU clock, turning off the monitor screen and stopping the HDD spindle motor.

Features

- CPU Speed 75~233MHz, Intel P54C, P55C/MMX, Cyrix 6x86, 6x86L, 6x86MX, AMD K5, K6
- Intel 430TX PCIset
- Up to 128MB system memory
- Onboard VGA CRT/LCD
- 16 level programmable watchdog timer
- High speed bi-directional SPP/ECP/EPP parallel port
- PC/104 connector
- Winbond W83781D Hardware Monitor IC that monitors CPU temperature, system temperature, system voltages and fan speeds
- Auto fan off
- Compliance with PISA Industrial Standards

Specifications

- **Processor Socket:** PGA socket
- **Processor:**
Intel Pentium/P55C/MMX) 75/90/100/120/133/150/166/200/233
Cyrix 6x86/6x86L P120+/P133+/P150+/P166+
Cyrix 6x86MX-166/180/200
AMD K5 PR75/PR90/PR100/PR120/PR133/PR150/PR166
AMD K6-166/200/233
- **Chipset:** Intel 430TX PCIset with built-in PCI EIDE
- **Secondary Cache:** 512KB P.B. SRAM
- **Memory:** Up to 128MB FPM/EDO DRAM
- **Memory Sockets:** Two 72-pin SIMM sockets for DRAMs in 4MB, 8MB, 16MB, 32MB and 64MB configurations.
- **BIOS:** Award BIOS, PnP support
 - FLASH EEPROM (256KB) for BIOS update
 - ISA Plug and Play (PnP) extension
 - Power management

- **Multi I/O:** Winbond 83977TF chipset
- **Parallel Port:** One high-speed parallel port, SPP/EPP/ECP mode
- **Serial Port:** Two 16550 UART compatible RS232/422/485 ports
- **Enhanced IDE:** Two Bus Mastering EIDE mode, up to 4 devices, Two EIDE interfaces for up to four devices, support PIO Mode 3/4 or Ultra DMA/33 IDE Hard Disk and ATAPI CD-ROM.
- **FDD Interface:** Two floppy drives (360KB, 720KB, 1.2MB, 1.44MB, 2.88MB, LS-120)
- **USB Interface:** Two USB pin-header connectors, compliant with USB Specification Rev. 1.0
- **Watchdog Timer:** 16-level, programmable
 - I/O port 0443H to enable watchdog.
 - I/O port 0441H to disable watchdog.
 - Time-out timing select 0/2/4/6/8/10/12/14/16/18/20/22/24/26/28/30 seconds (+/-20%).
- **Windows95 shut-off:** Powering off the system under Windows95
- **Modem ring-on:** Powering on the system via external modem
- **Green Function:** Power management via BIOS, activated through mouse/keyboard movement
- **Keyboard Connector:** PC/AT type mini-DIN that supports PC/AT and PS/2 keyboard; supports a 5-pin external keyboard connector
- **PS/2 Mouse Interface:** Pin-header connector
- **VGA Display:**
 - C&T 65550 VGA chip onboard
 - SVGA for CRT & Panel
 - 32-bit PCI local bus
 - VGA BIOS with 256KB flash ROM and system BIOS
 - 15-pin connector
 - 1024 X 768 (256 colors) resolution on SVGA(1MB memory)
 - 41-pin connector for LCD panel, 640 x 480 resolution
 - LCD panel supports monochrome, color STN, TFT, EL
 - Simultaneous VGA and panel display

- **IrDA Interface:** Pin-header connector for the optional IrDA external connector
- **Environmental and Mechanical:**
 - **Power Supply:** 3.5A @+5V
 - **Temperature:** 0°C to 60°C
 - **Humidity:** 5% to 95%
 - **Dimensions:** 185mm x 129mm (7.3" x 5.0")

Intelligence

- **CPU Slow Down:** When system overheat is detected, CPU slows down to prevent CPU damage. The CPU speed is restored when temperature falls to a safe level. System overheat is usually caused by malfunctioning of the CPU or system fan.
- **Auto Fan Off:** To reduce energy consumption and system noise, the system fan automatically powers off during **sleep mode**.
- **Temperature Monitoring and Alert:** A sensor for the CPU temperature on the CI5TTP monitors the CPU temperature and alerts the user through the speaker when temperature exceeds the safe heat level.
- **Voltage Monitoring and Alert:** Stable current are critical to system components. The CI5TTP monitors system voltage levels to ensure stable system performance.
- **Fan Status Monitoring:** The CPU fan and system fan speeds are monitored to prevent system overheat.
- **System Resources Alert:** Application crashes are sometimes caused by used up system resources. Suggestions are given to the user to effectively management their system resources.

Board Layout and Dimensions

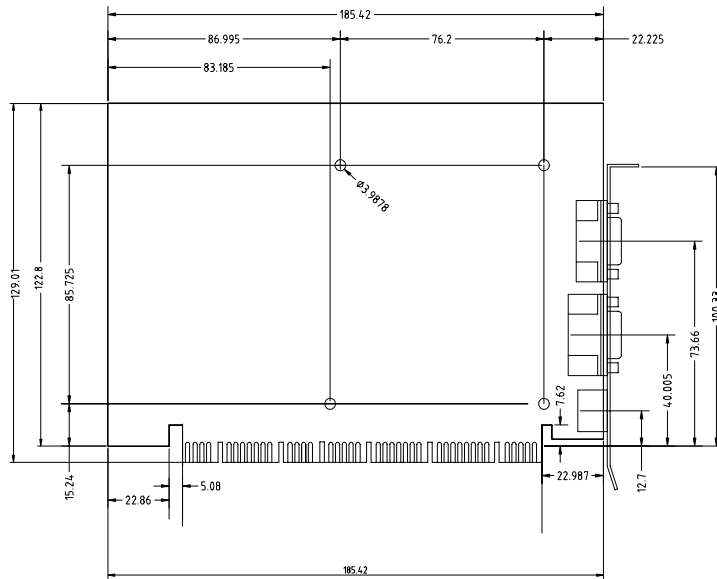
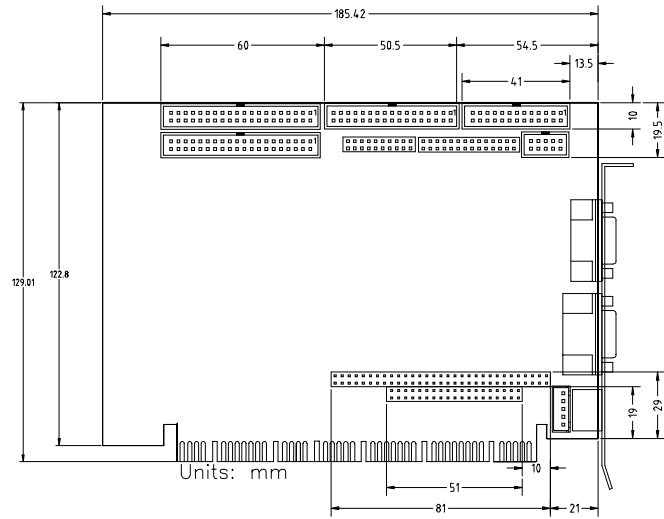

2

Installations

This chapter provides information on how to use the jumpers and connectors on the CI5TTP in order to set up a workable system. The topics covered are:

CPU Installation	8
Memory Installation	9
Jumpers on the CI5TTP.....	10
Connectors on the CI5TTP	20
Watchdog Timer Configuration.....	34

CPU Installation

The CISTTP Industrial CPU Card supports a PGA processor socket for Pentium-level processors.

Unlike ZIF (Zero Insertion Force) sockets, PGA sockets do not come with a lever to secure the processor. Rather, the processor is inserted into the PGA Socket by using a little force and is removed by using special pliers for processors.

After you have installed the processor into the PGA socket, be sure to check if the jumpers for the CPU type and speed are correct.

NOTE: *Ensure that the CPU heat sink and the CPU top surface are in total contact to avoid CPU overheating problem that would cause your system to hang or be unstable.*

Memory Installation

The CI5TTP Industrial CPU Card supports two 72-pin SIMM sockets for a maximum total memory of 128MB. The DRAMs (5Volts) for the SIMM sockets can be 4MB, 8MB, 16MB, 32MB, and 64MB in EDO and FPM types.

The following should be noted when populating the SIMM sockets:

1. SIMM1/SIMM2 should consist of the same size SIMMs.
2. SIMM1/SIMM2 should consist of the same type SIMMs. For example, *SIMM1 and SIMM2 are both be EDO or Page Mode.*

Memory Configuration	
(SIMM1, SIMM2)	Total Memory
4MB×2	8MB
8MB×2	16MB
16MB×2	32MB
32MB×2	64MB
64MB×2	128MB







Jumpers on the CI5TTP

The jumpers on the CI5TTP allows you to configure your CPU card according to the needs of your applications. If you have doubts about the best jumper configuration for your needs, contact your dealer or sales representative. The following table lists the connectors on CI5TTP and their respective functions.

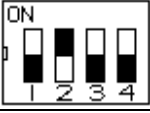
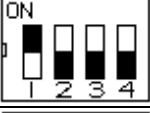

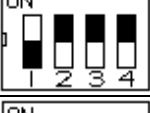
Jumper Locations on the CI5TTP	11
SW1 (1-4): CPU Frequency Selector	12
JP2, SW2 (1-4): CPU Voltage Selector	15
JP5: Clear CMOS Content	17
J17: External Battery Connector	17
JPW7: RS232/422/485 (COM2) Selection	18
JP9: DiskOnChip BIOS Expansion Address Select	18

SW1 (1-4): CPU Frequency Selector

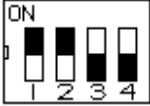
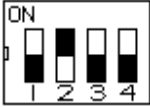
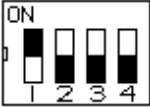
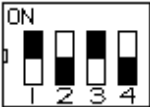
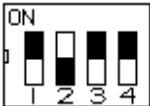

For Intel Pentium CPU

CPU FREQ.	Bus Clock Multiplier	SW1 (1-4)	Switch Setting
P54C-75	50MHz 1.5x		1 2 3 4 on on off off
P54C-90	60MHz 1.5x		1 2 3 4 off on off off
P54C-100	66MHz 1.5x		1 2 3 4 on off off off
P54C-120	60MHz 2x		1 2 3 4 off on on off
P54C-133	66MHz 2x		1 2 3 4 on off on off
P54C-150	60MHz 2.5x		1 2 3 4 off on on on
P54C/P55C-166	66MHz 2.5x		1 2 3 4 on off on on
P54C/P55C-200	66MHz 3x		1 2 3 4 on off off on
P55C-233	66MHz 3.5x		1 2 3 4 on off off off

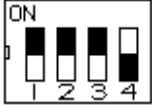

For AMD K5, K6 CPU

CPU FREQ.	Bus Clock Multiplier	SW1 (1-4)	Switch Setting
PR75	50MHz 1.5x		1 2 3 4 on on off off
PR90	60MHz 1.5x		1 2 3 4 off on off off
PR100	66MHz 1.5x		1 2 3 4 on off off off
PR133	66MHz 2x		1 2 3 4 on off on off
PR166	66MHz 2.5x		1 2 3 4 on off on on
K6-200	66MHz 3x		1 2 3 4 on off off on
K6-233	66MHz 3.5x		1 2 3 4 on off off off

For Cyrix 6x86, 6x86L CPU

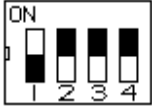
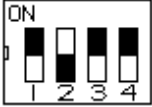

CPU FREQ.	Bus Clock Multiplier	SW1 (1-4)	Switch Setting
P120+ (100MHz)	50MHz 2x		1 2 3 4 on on on off
P150+ (120MHz)	60MHz 2x		1 2 3 4 off on on off
P166+ (133MHz)	66MHz 2x		1 2 3 4 on off on off

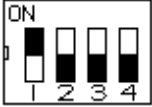
For Cyrix 6x86MX CPU

CPU FREQ.	Bus Clock Multiplier	SW1 (1-4)	Switch Setting
PR166 (150MHz)	60MHz 2.5x		1 2 3 4 off on on on
PR200 (166MHz)	66MHz 2.5x		1 2 3 4 on off on on
PR233 (200MHz)	66MHz 3x		1 2 3 4 on off off on
PR266 (233MHz)	66MHz 3.5x		1 2 3 4 on off off off



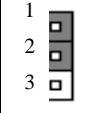

JP2, SW2 (1-4): CPU Voltage Selector

For Single Voltage CPU**: Intel P54C, Cyrix 6x86, AMD K5

JP2	SW2 (1-4)	Switch Setting	VIO	VCORE
		1 2 3 4 on on on on	3.5V	3.5V

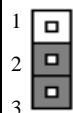
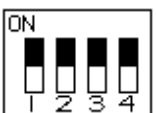
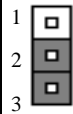
**Default

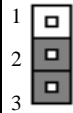
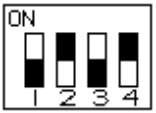
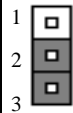
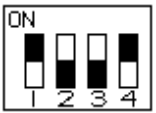
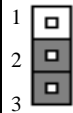
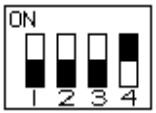
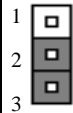
For Dual Voltage CPU: Intel P55C*, Cyrix 6x86L/MX, AMD K6









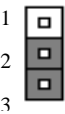
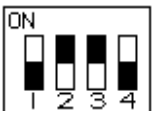
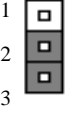
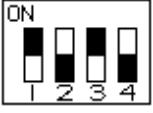
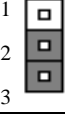

JP2	SW2 (1-4)	Switch Setting	VIO	VCORE	CPU
		1 2 3 4 on on on on	3.3V	3.5V	
		1 2 3 4 off off on on	3.3V	3.2V	K6-233
		1 2 3 4 off on off on	3.3V	3.0V	
		1 2 3 4 on off off on	3.3V	2.9V	K6-166 K6-200
		1 2 3 4 off off off on	3.3V	2.8V	P55C 6x86L
		1 2 3 4 on on on off	3.3V	2.7V	

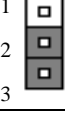
* P55C = Pentium MMX

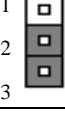
(continued on the next page)

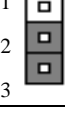
(continued from the previous page)

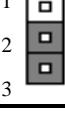
For Dual Voltage CPU: Intel P55C*, Cyrix 6x86L/MX, AMD K6

JP2	SW2 (1-4)	Switch Setting	VIO	VCORE	CPU
		1 2 3 4 off on on off	3.3V	2.6V	
		1 2 3 4 on off on off	3.3V	2.5V	
		1 2 3 4 off off on off	3.3V	2.4V	
		1 2 3 4 on on off off	3.3V	2.3V	
		1 2 3 4 off on off off	3.3V	2.2V	
		1 2 3 4 on off off off	3.3V	2.1V	
		1 2 3 4 off off off off	3.3V	2.0V	

JP5: Clear CMOS Content

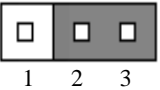
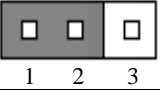
JP5	Jumper Setting	Function
 1 2 3	pin 2-3: closed	Clear CMOS Content
 1 2 3	pin 1-2: closed	Normal Operation

J17: External Battery Connector

This 4-pin connector allows the user to connect an external battery to maintain the information stored in the CMOS RAM in case the built-in battery malfunctions. The default is set to Internal Battery with a jumper connecting pin 1 and pin 2.

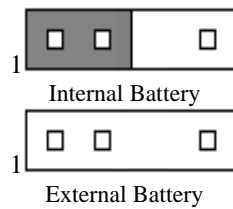

J17 Pin #	Signal Name
1	Ground
2	Battery GND
3	N.C.
4	Vcc

JPW7: RS232/422/485 (COM2) Selection

COM1 is fixed for RS-232 use only.

COM2 is selectable for RS232, RS-422 and RS-485.

The following table describes the jumper settings of this connector.

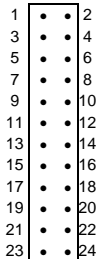
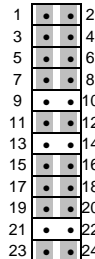
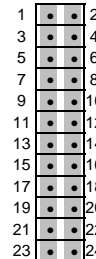
COM2 Function	RS-232	RS-422	RS-485
Jumper Setting (pin closed)	all jumpers open	1-2 3-4 5-6 7-8 11-12 15-16 17-18 19-20 23-24	1-2 3-4 5-6 7-8 9-10 11-12 13-14 15-16 17-18 19-20 21-22 23-24
Jumper Illustration	 <p>JPW7</p>	 <p>JPW7</p>	 <p>JPW7</p>

JP9: DiskOnChip BIOS Expansion Address Select

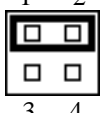
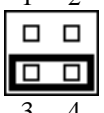
JP9	Address	JP9	Address
	D0000-D7FFF		D8000-DFFFF(default)

This page is intentionally left blank.

Connectors on the CI5TTP

The connectors on the CI5TTP allows you to connect external devices such as keyboard, floppy disk drives, hard disk drives, printers, etc. The following table lists the connectors on CI5TTP and their respective functions.

Connector Locations on the CI5TTP	21
J1: Chassis Fan Power Connector	22
JW1: IrDA Connector	22
JW2: Parallel Port Connector.....	22
JW3: AT Keyboard	23
JW4: PS/2 Mouse Connector	23
JW5: External Keyboard Connector.....	23
J5: LCD Panel Interface Selection	23
J6: Floppy Drive Connector	24
J8, J9: Serial Ports.....	24
J11, J12: USB Connectors	25
J13, J14: EIDE Connectors	26
J15: Front Bezel Connector.....	27
J18: CPU Fan Power Connector.....	29
J19: External ATX Power Connector.....	29
J20: LCD Panel Connector.....	30
Flat Panel Display Interface Pin Descriptions.....	31
J21: VGA CRT Connector	32
P1: Power Connector.....	32
CON1, CON2: PC-104 Connector	33

Connector Locations on the CI5TTP

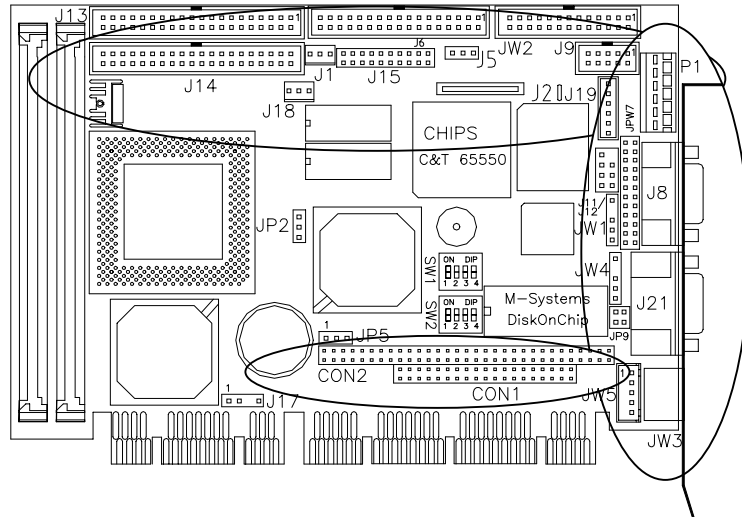

J1: Chassis Fan Power Connector

J1 is a 3-pin header for the chassis fan. The fan must be a 12V fan.

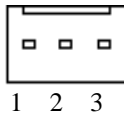

J1 Pin #	Signal Name
1	Rotation
2	+12V
3	Ground

JW1: IrDA Connector

This connector is used for an IrDA connector for wireless communication.

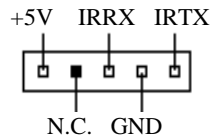

JW1 Pin #	Signal Name
1	+5V
2	No connect
3	Ir RX
4	Ground
5	Ir TX

JW2: Parallel Port Connector

The following table describes the pin out assignments of this connector.

A diagram of a 26-pin parallel port connector. It consists of a rectangular block with 26 square pins protruding from the top. The pins are numbered 1, 13, 14, and 26 from top to bottom.

Signal Name	Pin #	Pin #	Signal Name
Line printer strobe	1	14	AutoFeed
PD0, parallel data 0	2	15	Error
PD1, parallel data 1	3	16	Initialize
PD2, parallel data 2	4	17	Select
PD3, parallel data 3	5	18	Ground
PD4, parallel data 4	6	19	Ground
PD5, parallel data 5	7	20	Ground
PD6, parallel data 6	8	21	Ground
PD7, parallel data 7	9	22	Ground
ACK, acknowledge	10	23	Ground
Busy	11	24	Ground
Paper empty	12	25	Ground
Select	13	N/A	N/A

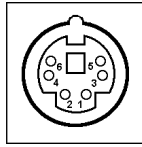
JW3: AT Keyboard

JW3 Pin #	Signal Name
1	Data
2	N.C.
3	GND
4	5V
5	Clock
6	N.C.

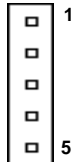
JW4: PS/2 Mouse Connector

JW4 Pin #	Signal Name
1	Mouse data
2	N.C.
3	GND
4	5V
5	Mouse Clock

JW5: External Keyboard Connector

JW5 Pin #	Signal Name
1	Keyboard Clock
2	Keyboard Data
3	PG
4	GND
5	Vcc

J5: LCD Panel Interface Selection

JP5	Setting	Function
 1 2 3	Pin 1-2 Short/Closed	3.3V
 1 2 3	Pin 2-3 Short/Closed	5V(default)

J6: Floppy Drive Connector

J6 is a 34-pin header and will support up to 2.88MB floppy drives.

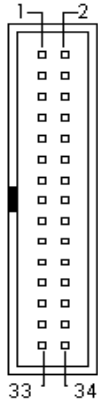

Signal Name	Pin #	Pin #	Signal Name
Ground	1	2	RM/LC
Ground	3	4	No connect
Ground	5	6	No connect
Ground	7	8	Index
Ground	9	10	Motor enable 0
Ground	11	12	Drive select 1
Ground	13	14	Drive select 0
Ground	15	16	Motor enable 1
Ground	17	18	Direction
Ground	19	20	Step
Ground	21	22	Write data
Ground	23	24	Write gate
Ground	25	26	Track 00
Ground	27	28	Write protect
Ground	29	30	Read data
Ground	31	32	Side 1 select
Ground	33	34	Diskette change

J8, J9: Serial Ports

The onboard serial ports of the CISTTP are a DB-9 and a 10 pin-header connector. J8 is COM1 and J9 is COM2. The following table shows the pin assignments of these connectors.

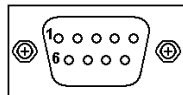

J8: COM1

Pin #	Signal Name
1	DCD, Data carrier detect
2	RXD, Receive data
3	TXD, Transmit data
4	DTR, Data terminal ready
5	GND, ground
6	DSR, Data set ready
7	RTS, Request to send
8	CTS, Clear to send
9	RI, Ring indicator

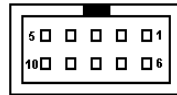

J9: COM2

Pin #	Signal Name		
	RS-232	R2-422	RS-485
1	DCD	TX-	DATA-
2	RX	TX+	DATA+
3	TX	RX+	NC
4	DTR	RX	NC
5	GND	GND	GND
6	DSR	RTS-	NC
7	RTS	RTS+	NC
8	CTS	CTS+	NC
9	RI	CTS-	NC
10	NC	NC	NC

J11, J12: USB Connectors

J11 and J12 are optional USB connectors. The following table shows the pin outs of these connectors.

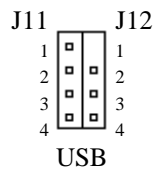

J11 Pin #	J12 Pin #	Signal Name
1	1	Vcc
2	2	USB-
3	3	USB+
4	4	Ground

J13, J14: EIDE Connectors

J13 is the *primary* IDE connector and J14 is the *secondary* IDE connector.

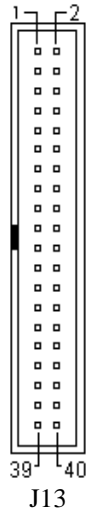

Signal Name	Pin #	Pin #	Signal Name
Reset IDE	1	2	Ground
Host data 7	3	4	Host data 8
Host data 6	5	6	Host data 9
Host data 5	7	8	Host data 10
Host data 4	9	10	Host data 11
Host data 3	11	12	Host data 12
Host data 2	13	14	Host data 13
Host data 1	15	16	Host data 14
Host data 0	17	18	Host data 15
Ground	19	20	Key
DRQ0	21	22	Ground
Host IOW	23	24	Ground
Host IOR	25	26	Ground
IOCHRDY	27	28	Host ALE
DACK0	29	30	Ground
IRQ14	31	32	No connect
Address 1	33	34	No connect
Address 0	35	36	Address 2
Chip select 0	37	38	Chip select 1
Activity	39	40	Ground

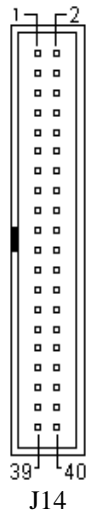

Signal Name	Pin #	Pin #	Signal Name
Reset IDE	1	2	Ground
Host data 7	3	4	Host data 8
Host data 6	5	6	Host data 9
Host data 5	7	8	Host data 10
Host data 4	9	10	Host data 11
Host data 3	11	12	Host data 12
Host data 2	13	14	Host data 13
Host data 1	15	16	Host data 14
Host data 0	17	18	Host data 15
Ground	19	20	Key
DRQ0	21	22	Ground
Host IOW	23	24	Ground
Host IOR	25	26	Ground
IOCHRDY	27	28	Host ALE
DACK1	29	30	Ground
MIRQ0	31	32	No connect
Address 1	33	34	No connect
Address 0	35	36	Address 2
Chip select 0	37	38	Chip select 1
Activity	39	40	Ground

J15: Front Bezel Connector

The front bezel of the case has a control panel which provides light indication of the computer activities and switches to change the computer status. J15 is a 20-pin header that provides interfaces for the following functions.

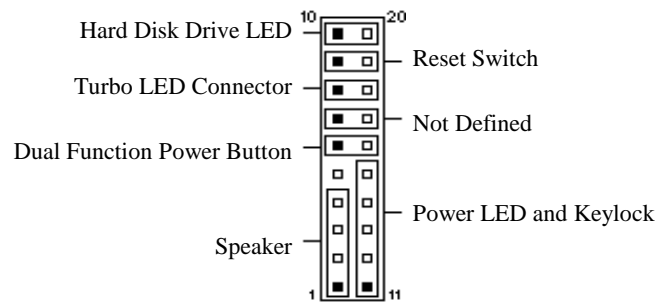

Speaker: Pins 1 - 4

This connector provides an interface to a speaker for audio tone generation. An 8-ohm speaker is recommended.



J15 Pin #	Signal Name
1	Speaker out
2	No connect
3	Ground
4	+5V

Dual Function Power Button: Pins 6 and 16

This connector provides two power modes: sleep and soft-off mode. Pushing the power button for less than 4 seconds places the system into sleep mode. Pressing the power button for more than 4 seconds puts the system into the soft-off mode. This function works with an ATX power supply.

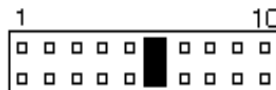

J15 Pin #	Signal Name
6	Sleep
16	Ground

Power LED and Keylock: Pins 11 - 15

The power LED indicates the status of the main power switch. The keylock switch, when closed, will disable the keyboard function.



J15 Pin #	Signal Name
11	Power LED
12	No connect
13	Ground
14	Keylock
15	Ground

Turbo LED Connector: Pins 8 and 18

There is the no turbo/deturbo function on the CPU card. The Turbo LED on the control panel will always be on when attached to this connector.

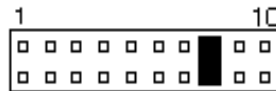

J15 Pin #	Signal Name
8	5V
18	Ground

Reset Switch: Pins 9 and 19

The reset switch allows the user to reset the system without turning the main power switch off and then on. Orientation is not required when making a connection to this header.

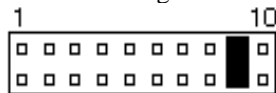

Hard Disk Drive LED Connector: Pins 10 and 20

This connector connects to the hard drive activity LED on control panel. This LED will flash when the HDD is being accessed.

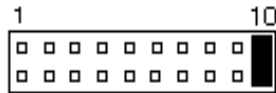

J18: CPU Fan Power Connector

J18 is a 3-pin header for the CPU fan. The fan must be a 12V fan.

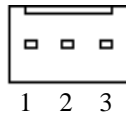

J18 Pin #	Signal Name
1	Rotation
2	+12V
3	Ground

J19: External ATX Power Connector

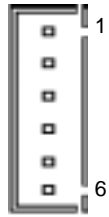

J19 Pin #	Signal Name
1	Dual function power button
2	GND
3	Dual function power button
4	GND
5	PS-ON (soft on/off)
6	5V SB (standby +5V)

J20: LCD Panel Connector

J20 is a 41-pin (dual in line header) for flat panel LCD displays. The following shows the pin assignments of this connector.

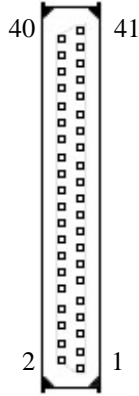

Signal Name	Pin #	Pin #	Signal Name
P20	1	2	GND
P16	3	4	VCC
P21	5	6	P0
P17	7	8	P8
P22	9	10	P1
P18	11	12	P9
P23	13	14	P2
P19	15	16	P10
VCC	17	18	P3
FLM	19	20	P11
MDE	21	22	P4
LP	23	24	P12
SHFCLK	25	26	P5
3.3V	27	28	P13
3.3V	29	30	P6
ENABKL	31	32	P14
LCDVDD	33	34	P7
ENVEE	35	36	P15
GND	37	38	+12V
GND	39	40	+12V
NC	41		

Flat Panel Display Interface Pin Descriptions

65550		Mono	Mono	Mono	Color	Color	Color	Color	Color	Color	Color	Color
		SS	DD	DD	TFT	TFT	Color STN	Color	Color	Color	Color	Color
Pin#	Pin Name	8-bit	8-bit	16-bit	9/12/16 bit	18/24 bit	18/24 bit	8-bit (X4bP)	16-bit (4bP)	8-bit (4bP)	16-bit (4bP)	24-bit
71	P0	--	UD3	UD7	B0	B0	B00	R1	R1	UR1	UR0	UR0
72	P1	--	UD2	UD6	B1	B1	B01	B1	G1	UG1	UG0	UG0
73	P2	--	UD1	UD5	B2	B2	B02	G2	B1	UB1	UB0	UB0
74	P3	--	UD0	UD4	B3	B3	B03	R3	R2	UR2	UR1	LR0
75	P4	--	LD3	UD3	B4	B4	B10	B3	G2	LR1	LR0	LG0
76	P5	--	LD2	UD2	G0	B5	B11	G4	B2	LG1	LG0	LB0
78	P6	--	LD1	UD1	G1	B6	B12	R5	R3	LB1	LB0	UR1
79	P7	--	LD0	UD0	G2	B7	B13	B5	G3	LR2	LR1	UG1
81	P8	P0	--	LD7	G3	G0	G00	Shfclk	B3	--	UG1	UB1
82	P9	P1	--	LD6	G4	G1	G01	--	R4	--	UB1	LR1
83	P10	P2	--	LD5	G5	G2	G02	--	G4	--	UR2	LG1
84	P11	P3	--	LD4	R0	G3	G03	--	B4	--	UG2	LB1
85	P12	P4	--	LD3	R1	G4	G10	--	R5	--	LG1	UR2
86	P13	P5	--	LD2	R2	G5	G11	--	G5	--	LB1	UG2
87	P14	P6	--	LD1	R3	G6	G12	--	B5	--	LR2	UB2
88	P15	P7	--	LD0	R4	G7	G13	--	R6	--	LG2	LR2
90	P16	--	--	--	--	R0	R00	--	--	--	--	LG2
91	P17	--	--	--	--	R1	R01	--	--	--	--	LB2
92	P18	--	--	--	--	R2	R02	--	--	--	--	UR3
93	P19	--	--	--	--	R3	R03	--	--	--	--	UG3
94	P20	--	--	--	--	R4	R10	--	--	--	--	UB3
95	P21	--	--	--	--	R5	R11	--	--	--	--	LR3
96	P22	--	--	--	--	R6	R12	--	--	--	--	LG3
97	P23	--	--	--	--	R7	R13	--	--	--	--	LB3
67	FLM	FLM	FLM	FLM	FLM	FLM	FLM	FLM	FLM	FLM	FLM	FLM
68	LP	LP	LP	LP	LP	LP	LP	LP	LP	LP	LP	LP
69	MDE	M	M	M	M	M	M	M	M	M	M	M
70	ShfClk	ShfClk	ShfClk	ShfClk	ShfClk	ShfClk	ShfClk	ShfClk	ShfClk	ShfClk	ShfClk	ShfClk
	Pixels/ Clock	8	8	16	1	1	2	2-2/3	5-1/3	2-2/3	5-1/3	8

NOTE: The higher order output lines should be used when only 9 or 12 bits are needed from the 9/12/16-bit TFT interface, or when only 18 bits are needed from the 18/24-bit TFT or TFT HR interfaces. The lower order bits should be left unconnected.

J21: VGA CRT Connector

J21 is a 15-pin VGA CRT connector. The pin assignments are as follows:

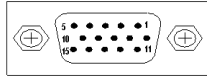

Signal Name	Pin #	Pin #	Signal Name
Red	1	2	Green
Blue	3	4	N.C.
GND	5	6	GND
GND	7	8	GND
N.C.	9	10	GND
N.C.	11	12	N.C.
HSYNC	13	14	VSYNC
NC	15		

P1: Power Connector

When using an AT compatible power supply, plug the power supply connectors into P1. Make sure the power supply connectors are connected in the right orientation. See the pin assignments below.

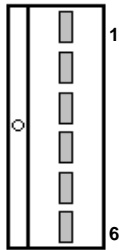

P1 Pin #	Signal Name
1	N.C.
2	+5V
3	+12V
4	-12V
5	GND
6	GND

CON1, CON2: PC-104 Connector

CON1 and CON2 are dual-in-line pin headers that support PC-104 modules. CON1 consists of 64 pins and CON2 has 40 pins. The following table shows the their pin assignments.

CON1				CON2			
Pin	Signal Name	Pin	Signal Name	Pin	Signal Name	Pin	Signal Name
A1	IOCHK	B1	GND	C1	GND	D1	GND
A2	D7	B2	REST	C2	SBHE	D2	MEMCS16
A3	D6	B3	VCC	C3	LA23	D3	IOCS16
A4	D5	B4	IRQ9	C4	LA22	D4	IRQ10
A5	D4	B5	-5V	C5	LA21	D5	IRQ11
A6	D3	B6	DRQ2	C6	LA20	D6	IRQ12
A7	D2	B7	-12V	C7	LA19	D7	IRQ15
A8	D1	B8	OWS	C8	LA18	D8	IRQ14
A9	D0	B9	+12V	C9	LA17	D9	DACK0
A10	IOCHRDY	B10	GND	C10	MEMR	D10	DRQ0
A11	AEN	B11	SMEMW	C11	MEMW	D11	DACK5
A12	A19	B12	SMEMR	C12	D8	D12	DRQ5
A13	A18	B13	IOW	C13	D9	D13	DACK6
A14	A17	B14	IOR	C14	D10	D14	DRQ6
ZA15	A16	B15	DACK3	C15	D11	D15	DACK7
A16	A15	B16	DRQ3	C16	D12	D16	DRQ7
A17	A14	B17	DACK1	C17	D13	D17	VCC
A18	A13	B18	DRQ1	C18	D14	D18	MASTER
A19	A12	B19	REFRESH	C19	D15	D19	GND
A20	A11	B20	CLK	C20	KEY PIN	D20	GND
A21	A10	B21	IRQ7				
A22	A9	B22	IRQ6				
A23	A8	B23	IRQ5				
A24	A7	B24	IRQ4				
A25	A6	B25	IRQ3				
A26	A5	B26	DACK2				
A27	A4	B27	TC				
A28	A3	B28	BALE				
A29	A2	B29	VCC				
A30	A1	B30	OSC				
A31	A0	B31	GND				
A32	GND	B32	GND				

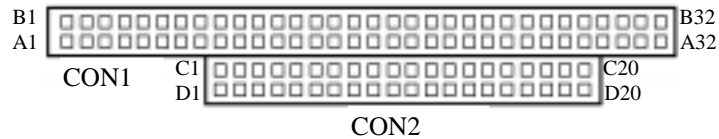

Watchdog Timer Configuration

The function of the watchdog timer is to reset the system automatically and is defined at I/O port 0443H. To enable the watchdog timer and allow the system to reset, write I/O port 0443H. To disable the timer, write I/O port 0441H for the system to stop the watchdog function. The timer has a tolerance of 20% for its intervals.

The following describes how the timer should be programmed.

Enabling Watchdog:

```
MOV AX, 000FH (Choose the values from 0)
MOV DX, 0443H
OUT DX, AX
```

Disabling Watchdog

```
MOV AX, 00FH (Any value is fine.)
MOV DX, 0441H
OUT DX, AX
```

WATCHDOG TIMER CONTROL TABLE

Level	Value	Time/sec	Level	Value	Time/sec
1	F	0	9	7	16
2	E	2	10	6	18
3	D	4	11	5	20
4	C	6	12	4	22
5	B	8	13	3	24
6	A	10	14	2	26
7	9	12	15	1	28
8	8	14	16	0	30

3

BIOS Configuration

This chapter describes the different settings available in the Award BIOS that comes with the CI5TTP CPU card. The topics covered in this chapter are as follows:

BIOS Introduction.....	38
BIOS Setup	38
Standard CMOS Setup.....	39
Date	40
Time	40
Primary HDDs / Secondary HDDs.....	41
Drive A / Drive B	42
Floppy 3 Mode Support.....	42
Video.....	42
Halt On.....	42
BIOS Features Setup.....	43
Virus Warning	43
CPU Internal Cache / External Cache	43
Quick Power On Self Test.....	44
Boot Sequence.....	44
Swap Floppy Drive.....	44
Boot Up Floppy Seek	44
Boot Up NumLock Status	44
Boot Up System Speed.....	44
Gate A20 Option	44
Typematic Rate Setting	44
Typematic Rate (Chars/Sec).....	45
Typematic Delay (Msec).....	45
Security Option	45

PCI/VGA Palette Snoop	45
OS Select for DRAM > 64MB	45
Video BIOS Shadow	45
C8000 - CBFFF Shadow/DC000 - DFFFF Shadow	45
Chipset Features Setup	46
DRAM Timing	46
System BIOS Cacheable	46
Video BIOS Cacheable	46
8 Bit I/O Recovery Time	46
16 Bit I/O Recovery Time	46
Memory Hole at 15M-16M	47
PCI 2.1 Compliance	47
Power-Supply Type	47
CPU Warning Temperature	47
Current CPU and System Temperature	47
CPU and Chassis Fan Speed	47
Voltage Monitoring	47
Power Management Setup	48
Power Management	48
PM Control by APM	48
Video Off Method	49
Video Off After	49
Doze Mode	49
Standby Mode	49
Suspend Mode	49
HDD Power Down	49
VGA Active Monitor	49
Soft-Off by PWR-BTTN	49
IRQ 8 Break Suspend	50
CPU Fan Off in Suspend	50
Resume by Ring	50
Resume by Alarm	50
Reload Global Timer Events	50
PNP/PCI Configuration	51
PNP OS Installed	51
Resources Controlled by	51
Reset Configuration Data	51
IRQ3/4/5/7/9/10/11/12/14/15, DMA0/1/3/5/6/7 assigned to	51
Used MEM base addr	52
Load BIOS Defaults	53
Load Setup Defaults	53

Integrated Peripherals	54
IDE HDD Block Mode.....	54
IDE Primary Master/Slave PIO and Secondary Master/Slave PIO	54
IDE Primary Master/Slave UDMA and Secondary Master/Slave UDMA	54
On-Chip Primary/Secondary PCI IDE.....	55
USB Keyboard Support.....	55
Onboard FDD Controller	55
Onboard Serial/Parallel Port.....	55
UART 2 Mode.....	55
Parallel Port Mode	55
Supervisor / User Password	56
IDE HDD Auto Detection.....	57
HDD Low Level Format	57
Save & Exit Setup	58
Exit Without Saving.....	58

BIOS Introduction

The Award BIOS (Basic Input/Output System) installed in your computer system's ROM supports Intel/Cyrix/AMD processors in a standard IBM-AT compatible I/O system. The BIOS provides critical low-level support for standard devices such as disk drives, serial and parallel ports. It also adds virus and password protection as well as special support for detailed fine-tuning of the chipset controlling the entire system.

BIOS Setup

The Award BIOS provides a Setup utility program for specifying the system configurations and settings. The BIOS ROM of the system stores the Setup utility. When you turn on the computer, the Award BIOS is immediately activated. Pressing the key immediately allows you to enter the Setup utility. If you are a little bit late pressing the key, POST(Power On Self Test) will continue with its test routines, thus preventing you from invoking the Setup. If you still wish to enter Setup, restart the system by pressing the "Reset" button or simultaneously pressing the <Ctrl>, <Alt> and <Delete> keys. You can also restart by turning the system Off and back On again. The following message will appear on the screen:

Press to Enter Setup

In general, you press the arrow keys to highlight items, <Enter> to select, the <PgUp> and <PgDn> keys to change entries, <F1> for help and <Esc> to quit.

When you enter the Setup utility, the Main Menu screen will appear on the screen. The Main Menu allows you to select from various setup functions and exit choices.

ROM PCI/ISA BIOS
CMOS SETUP UTILITY
AWARD SOFTWARE, INC.

STANDARD CMOS SETUP	INTEGRATED PERIPHERALS
BIOS FEATURES SETUP	SUPERVISOR PASSWORD
CHIPSET FEATURES SETUP	USER PASSWORD
POWER MANAGEMENT SETUP	IDE HDD AUTO DETECTION
PNP/PCI CONFIGURATION	HDD LOW LEVEL FORMAT
LOAD BIOS DEFAULTS	SAVE & EXIT SETUP
LOAD SETUP DEFAULTS	EXIT WITHOUT SAVING
ESC : Quit	↑ ↓ → ← : Select Item
F10 : Save & Exit Setup	(Shift) F2 : Change Color
Time, Date, Hard Disk Type	

The section below the setup items of the Main Menu displays the control keys for this menu. Another section at the bottom of the Main Menu just below the control keys section displays information on the currently highlighted item in the list.

NOTE: *After making and saving system changes with Setup, you find that your computer cannot boot, the Award BIOS supports an override to the CMOS settings that resets your system to its default.*

We strongly recommend that you avoid making any changes to the chipset defaults. These defaults have been carefully chosen by both Award and your system manufacturer to provide the absolute maximum performance and reliability.

Standard CMOS Setup

“Standard CMOS Setup” choice allows you to record some basic hardware configurations in your computer system and set the system clock and error handling. If the CPU card is already installed in a working system, you will not need to select this option. You will need to run the Standard CMOS option, however, if you change your system hardware configurations, the onboard battery fails, or the configuration stored in the CMOS memory was lost or damaged.

ROM PCI/ISA BIOS
STANDARD CMOS SETUP
AWARD SOFTWARE, INC.

Date (mm:dd:yy) : Wed, Jan 1 1997								
Time (hh:mm:ss) : 00 : 00 : 00								
HARD DISKS	TYPE	SIZE	CYLS	HEAD	PRECOMP	LANDZ	SECTOR	MODE
Primary Master	Auto	0	0	0	0	0	0	Auto
Primary Slave	None	0	0	0	0	0	0	-----
Secondary Master	None	0	0	0	0	0	0	-----
Secondary Slave	None	0	0	0	0	0	0	-----
Drive A	: 1.44M, 3.5 in				Base Memory		:	640K
Drive B	: None				Extended Memory		:	31744K
Floppy 3 Mode Support	: Disabled				Other Memory		:	384K
Video	: EGA / VGA				Total Memory		:	32768K
Halt On	: All Errors							
ESC : Quit			↑ ↓ → ← : Select			Item PU / PD / + / - : Modify		
F1 : Help			(Shift) F2 : Change Color					

At the bottom of the menu are the control keys for use on this menu. If you need any help in each item field, you can press the <F1> key. It will display the relevant information to help you. The memory display at the lower right-hand side of the menu is read-only. It will adjust automatically according to the memory changed. The following describes each item of this menu.

Date

The date format is:

Day : Sun to Sat
Month : 1 to 12
Date : 1 to 31
Year : 1900 to 2099

To set the date, highlight the "Date" field and use the PageUp/ PageDown or +/- keys to set the current time.

Time

The time format is: **Hour : 00 to 23**
Minute : 00 to 59
Second : 00 to 59

To set the time, highlight the "Time" field and use the <PgUp>/ <PgDn> or +/- keys to set the current time.

Primary HDDs / Secondary HDDs

The onboard PCI IDE connectors provide Primary and Secondary channels for connecting up to four IDE hard disks or other IDE devices. Each channel can support up to two hard disks; the first is the "Master" and the second is the "Slave".

To enter the specifications for a hard disk drive, you must select first a "Type". There are 45 predefined types and 4 user definable types are for Enhanced IDE BIOS. Type 1 to 45 are predefined. Type "User" is user-definable. For the Primary Master/Slave as well as Secondary Master/Slave, you can select "Auto" under the TYPE and MODE fields. This will enable auto detection of your IDE drives and CD-ROM drive during POST.

Press <PgUp>/<PgDn> to select a numbered hard disk type or type the number and press the <Enter> key. The hard disk will not work properly if you enter incorrect information for this field. If your hard disk drive type is not matched or listed, you can use Type User to define your own drive type manually. If you select Type User, related information is asked to be entered to the following items.

CYLS : Number of cylinders
HEAD : Number of read/write heads
PRECOMP : Write precompensation
LANDZ : Landing zone
SECTOR : Number of sectors
SIZE : Automatically adjust according to the configuration
MODE (for IDE HDD only) : Auto
 Normal (HD < 528MB)
 Large (for MS-DOS only)
 LBA (HD > 528MB and supports
 Logical Block Addressing)

NOTE: *The specifications of your drive must match with the drive table. The hard disk will not work properly if you enter incorrect information in these fields. If your hard disk drive type is not matched or listed, you can use Type User to define your own drive type manually.*

Drive A / Drive B

These fields identify the types of floppy disk drive, A or drive B, that has been installed in the computer. The available specifications are:

360KB	1.2MB	720KB	1.44MB	2.88MB
5.25 in.	5.25 in.	3.5 in.	3.5 in.	3.5 in.

Floppy 3 Mode Support

This is the Japanese standard floppy drive. The standard stores 1.2MB in a 3.5-inch diskette. You have four options to choose:

Disabled	No 3 mode floppy drive installed. (default)
Drive A	Installed 3 mode drive at drive A.
Drive B	Installed 3 mode drive at drive B.
Both	Installed 3 mode drive at drive A and B.

Video

This field selects the type of video display card installed in your system. You can choose the following video display cards:

EGA/VGA	For EGA, VGA, SEGA, SVGA or VGA monitor adapters.(default)
CGA 40	Power up in 40 column mode.
CGA 80	Power up in 80 column mode.
MONO	For Hercules or MDA, includes high resolution monochrome adapters.

Halt On

This field determines whether the system will halt if an error is detected during power up.

No errors	The system boot will not be halted for any error that may be detected. (default)
All errors	Whenever the BIOS detects a non-fatal error, the system will be halted and you will be prompted.
All, But Keyboard	The system boot will not be halted for a keyboard error; it will stop for all other errors.
All, But Diskette	The system boot will not be halted for a disk error; it will stop for all other errors.
All, But Disk/Key	The system boot will not be halted for a keyboard or disk error; it will stop for all other errors.

BIOS Features Setup

This section allows you to configure and improve your system and allows you to set up some system features according to your preference.

ROM / PCI ISA BIOS
BIOS FEATURES SETUP
AWARD SOFTWARE, INC.

Virus Warning	: Disabled	Video BIOS Shadow	: Enabled
CPU Internal Cache	: Enabled	C8000-CBFFF Shadow	: Disabled
External Cache	: Enabled	CC000-CFFFF Shadow	: Disabled
Quick Power On Self Test	: Disabled	D0000-D3FFF Shadow	: Disabled
Boot Sequence	: A, C, SCSI	D4000-D7FFF Shadow	: Disabled
Swap Floppy Drive	: Disabled	D8000-DBFFF Shadow	: Disabled
Boot Up Floppy Drive	: Enabled	DC000-DFFF Shadow	: Disabled
Boot Up Numlock Status	: On		
Boot Up System Speed	: High		
Gate A20 Option	: Fast		
Typematic Rate Setting	: Disabled		
Typematic Rate (chars/Sec)	: 6		
Typematic Delay (Msec)	: 250		
Security Option	: Setup		
PCI /VGA Palette Snoop	: Disabled		
OS Select For DRAM>64MB	: Non-OS2		
		ESC : Quit	↑ ↓ → ← : Select Item
		F1 : Help	PU/PD/+/- : Modify
		F5 : Old Values	(Shift) F2 : Color
		F6 : Load BIOS Defaults	
		F7 : Load Setup Defaults	

Virus Warning

This item protects the boot sector and partition table of your hard disk against accidental modifications. If an attempt is made, the BIOS will halt the system and display a warning message. If this occurs, you can either allow the operation to continue or run an anti-virus program to locate and remove the problem.

NOTE: Many disk diagnostic programs which attempt to access the boot sector table can cause the virus warning. If you will run such a program, disable the Virus Warning feature.

CPU Internal Cache / External Cache

These items allow you to enable (speed up memory access) or disable the cache function. By default, these items are **Enabled**.

Quick Power On Self Test

This choice speeds up the Power On Self Test (POST) after you power up the system. If it is set to *Enabled*, BIOS will skip some items. By default, this choice is *Enabled*.

Boot Sequence

This field determines the drive that the system searches first for an operating system. The options are :

A, C, SCSI	D, A, SCSI	SCSI, C, A
C, A, SCSI	E, A, SCSI	C only
C, CDROM, A	F, A, SCSI	LS/ZIP, C
CDROM, C, A	SCSI, A, C	

The default value is *A, C, SCSI*.

Swap Floppy Drive

This item allows you to determine whether to enable Swap Floppy Drive or not. When enabled, the BIOS swaps floppy drive assignments so that Drive A becomes Drive B, and Drive B becomes Drive A. By default, this field is set to *Disabled*.

Boot Up Floppy Seek

When enabled, the BIOS will seek whether or not the floppy drive installed has 40 or 80 tracks. 360K type has 40 tracks while 760K, 1.2M and 1.44M all have 80 tracks. By default, this field is set to *Enabled*.

Boot Up NumLock Status

This allows you to activate the NumLock function after you power up the system. By default, the system boots up with *NumLock* On.

Boot Up System Speed

This has no function and selects the default system speed (*High*).

Gate A20 Option

This field allows you to select how Gate A20 is worked. The Gate A20 is a device used to address memory above 1 MB. By default, this field is set to *Fast*.

Typematic Rate Setting

When disabled, continually holding down a key on your keyboard will generate only one instance. When enabled, you can set the two typematic controls listed next. By default, this field is set to *Disabled*.

Typematic Rate (Chars/Sec)

When the typematic rate is enabled, the system registers repeated keystrokes speeds. You can select speed range from 6 to 30 characters per second. By default, this item is set to **6**.

Typematic Delay (Msec)

When the typematic rate is enabled, this item allows you to set the time interval for displaying the first and second characters. By default, this item is set to **250msec**.

Security Option

This field allows you to limit access to the System and Setup. The default value is **Setup**. When you select **System**, the system prompts for the User Password every time you boot up. When you select **Setup**, the system always boots up and prompts for the Supervisor Password only when the Setup utility is called up.

PCI/VGA Palette Snoop

Some display cards that are non-standard VGA may not show colors properly. This field allows you to set whether MPEG ISA/VESA VGA Cards can work with PCI/VGA or not. When this field is enabled, a PCI/VGA can work with a MPEG ISA/VESA VGA card. When this field is disabled, a PCI/VGA cannot work with a MPEG ISA/VESA Card.

OS Select for DRAM > 64MB

This option allows the system to access greater than 64MB of DRAM memory when used with OS/2 that depends on certain BIOS calls to access memory. The default setting is **NON-OS/2**.

Video BIOS Shadow

This item allows you to change the Video BIOS location from ROM to RAM. Video Shadow will increase the video speed.

C8000 - CBFFF Shadow/DC000 - DFFFF Shadow

Shadowing a ROM reduces the memory available between 640KB to 1024KB. These fields determine whether optional ROM will be copied to RAM or not.

Chipset Features Setup

This Setup menu controls the configuration of the CPU card chipset.

ROM PCI/ISA BIOS
CHIPSET FEATURES SETUP
AWARD SOFTWARE INC.

DRAM Timing	: 70ns	CPU Warning Temperature	: 80°C/176°F
System BIOS Cacheable	: Disabled	Current CPU Temperature	: 37°C/98°F
Video BIOS Cacheable	: Enabled		
8 Bit I/O Recovery Time	: 2	Current System Temp.	: 25°C/77°F
16 Bit I/O Recovery Time	: 4	Current CPU Fan Speed	: 5720 RPM
Memory Hole At 15M-16M	: Disabled	Current Chassis Fan Speed	: 5443 RPM
PCI 2.1 Compliance	: Disabled	VIO	: 3.31 V VCORE : 2.84V
Power-Supply Type	: Auto	+12(V)	: 11.26V +5 (V) : 5.11V
		- 5 (V)	: -4.84V -12 (V) : -10.93V

ESC : Quit ↑ ↓ → ← : Select Item
F1 : Help PU/PD/+/- : Modify
F5 : Old Values (Shift) F2 : Color
F6 : Load BIOS Defaults
F7 : Load Setup Defaults

DRAM Timing

The DRAM timing is controlled by the DRAM Timing Registers. The timing type is dependent on the system design. Slower rates may be required in some system designs to support loose layouts or slower memory.

System BIOS Cacheable

When enabled, access to the system BIOS ROM addressed at F0000H-FFFFFH are cached, provided that the cache controller is enabled.

Video BIOS Cacheable

When enabled, access to video BIOS addressed at C0000H to C7FFFH are cached, provided that the cache controller is disabled.

8 Bit I/O Recovery Time

The I/O recovery mechanism adds bus clock cycles between PCI-originated I/O cycles to the ISA bus. This delay takes place because the PCI bus is so much faster than the ISA bus. This field let you add recovery time (in bus clock cycles) for 8-bit I/O.

16 Bit I/O Recovery Time

The I/O recovery mechanism adds bus clock cycles between PCI-originated I/O cycles to the ISA bus. This delay takes place because the PCI bus is so much faster than the ISA bus. This field let you add recovery time (in bus clock cycles) for 16-bit I/O.

Memory Hole at 15M-16M

In order to improve performance, certain space in memory can be reserved for ISA cards. This field allows you to reserve 15MB to 16MB memory address space to ISA expansion cards. This makes memory from 15MB and up unavailable to the system. Expansion cards can only access memory up to 16MB. By default, this field is set to *Disabled*.

PCI 2.1 Compliance

Concurrent PCI allows multiple PCI transfers from the PCI master buses to memory to CPU. By default, this field is set to *Disabled*.

Power-Supply Type

This field allows you to select the type of power supply used. The settings are *Auto*, *P8&P9*, or *ATX*. The default setting is *Auto*.

P8&P9	AT power supply type.
ATX	ATX power supply type

CPU Warning Temperature

The onboard hardware thermal sensor monitors CPU temperature changes and prevents the CPU from overheating. Alert is sounded through the speaker and CPU speed slows down when the temperature exceeds the temperature set in the BIOS until the temperature falls below a safe level. By default, this field is set to *80°C/176°F*.

Current CPU and System Temperature

These fields show the current system and system temperature as monitored by the sensor under the CPU. This is a function of the optional System Hardware Monitoring Device.

CPU and Chassis Fan Speed

These fields show the RPM (revolution per minute) status of your CPU fan and Chassis fan. This is a function of the optional System Hardware Monitoring Device.

Voltage Monitoring

These fields show the monitored current voltages in the voltage regulators and the system's power supply. This is a function of the optional System Hardware Monitoring Device.

Power Management Setup

The Power Management Setup allows you to save energy of your system effectively. It will shut down the hard disk and turn off video display after a period of inactivity.

ROM PCI/ISA BIOS (2A59IM29)
POWER MANAGEMENT SETUP
AWARD SOFTWARE, INC.

Power Management	: Disabled	** Reload Global Timer Events **
PM Control by APM	: Yes	IRQ3 [3-7, 9-15],NMI : Enabled
Video Off Method	: V/H SYNC +Blank	Primary IDE 0 : Disabled
Video Off After	: Suspend	Primary IDE 1 : Disabled
Doze Mode	: Disabled	Secondary IDE 0 : Disabled
Standby Mode	: Disabled	Secondary IDE 1 : Disabled
Suspend Mode	: Disabled	Floppy Disk : Disabled
HDD Power Down	: Disabled	Serial Port : Enabled
VGA Active Monitor	: Enabled	Parallel Port : Disabled
Soft-off by PWR-BTTN	: Instant Off	
CPUFAN Off In Suspend	: Enabled	
IRQ 8 Break Suspend	: Disabled	ESC : Quit ↑ ↓ → ← : Select Item
Resume by Ring	: Disabled	F1 : Help PU/PD/+/- : Modify
Resume by Alarm	: Disabled	F5 : Old Values (Shift) F2 : Color
		F6 : Load BIOS Defaults
		F7 : Load Setup Defaults

Power Management

This field allows you to select the type of power saving management modes. There are four selections for Power Management.

- Disable No power management. (Default)
- Min. Power Saving Minimum power management.
- Max. Power Saving Maximum power management. Only available for SL CPU.
- User Define Each of the ranges are from 1 min. to 1hr. Except for HDD Power Down which ranges from 1 min. to 15 min.

PM Control by APM

This field allows you to use the Advanced Power Management device to enhance the Max. Power Saving mode and stop the CPU's internal clock. If the Max. Power Saving is not enabled, this will be preset to NO.

Video Off Method

This field defines the Video Off features. There are three options.

V/H SYNC + Blank	Default setting, blank the screen and turn off vertical and horizontal scanning.
DPMS	Allows the BIOS to control the video display card if it supports the DPMS feature.
Blank Screen	This option only writes blanks to the video buffer.

Video Off After

This field specifies the mode after which the Video Off feature is enabled. The options are *Doze*, *Standby*, *Suspend*, and *N/A*.

Doze Mode

When enabled, and after the set time of system inactivity, the CPU clock will run at a slower speed while all other devices still operate at full speed.

Standby Mode

When enabled, and after the set time of system inactivity, the fixed disk drive and the video would be shut off while all other devices still operate at full speed.

Suspend Mode

When enabled, and after the set time of system inactivity, all devices except the CPU will be shut off.

HDD Power Down

When enabled, and after the set time of system inactivity, the hard disk drive will be powered down while all other devices remain active.

VGA Active Monitor

This option specifies if the BIOS is to monitor activity on the display monitor for power conservation purposes.

Soft-Off by PWR-BTTN

This field specifies the power-off mode of the ATX system. The *Instant Off Mode* allows powering off immediately upon pressing the power button. In the *Delay 4 Secs Mode*, the system powers off after pressing the power button for more than four seconds. By default, this field is set to *Instant Off Mode*.

IRQ 8 Break Suspend

This section sets the wake-up call of the system. If activity is detected from the enabled IRQ 8, the system wakes up from suspend mode.

CPU Fan Off in Suspend

The system fans will power off automatically, even in suspend mode. This function reduces both energy consumption and system noise.

Resume by Ring

This allows a computer to be turned on remotely through a modem. By default, this field is set to *Disabled*.

Resume by Alarm

This allows a computer to be turned on automatically through the timer set in the BIOS to make the system more scheduleable. By default, this field is set to *Disabled*.

Reload Global Timer Events

This section determines the reloading of the ‘timers’ after entering the Full On mode. When enabled, the item reloads the set time of inactivity before entering the power saving mode.

PNP/PCI Configuration

This option configures the PCI bus system. All PCI bus systems on the system use INT#, thus all installed PCI cards must be set to this value.

ROM PCI/ISA BIOS
PNP/PCI CONFIGURATION
AWARD SOFTWARE INC.

PNP OS Installed	: Yes	Used MEM base addr	: N/A
Resources Controlled by	: Manual		
Reset Configuration Data	: Disabled		
IRQ-3 assigned to	: Legacy ISA		
IRQ-4 assigned to	: Legacy ISA		
IRQ-5 assigned to	: Legacy ISA		
IRQ-7 assigned to	: Legacy ISA		
IRQ-9 assigned to	: PCI/ISA PnP		
IRQ-10 assigned to	: PCI/ISA PnP		
IRQ-11 assigned to	: PCI/ISA PnP		
IRQ-12 assigned to	: PCI/ISA PnP		
IRQ-14 assigned to	: PCI/ISA PnP		
IRQ-15 assigned to	: PCI/ISA PnP		
DMA-0 assigned to	: PCI/ISA PnP		
DMA-1 assigned to	: PCI/ISA PnP	ESC : Quit	↑ ↓ ← : Select Item
DMA-3 assigned to	: PCI/ISA PnP	F1 : Help	PU/PD/+/- : Modify
DMA-5 assigned to	: PCI/ISA PnP	F5 : Old Values	(Shift) F2 : Color
DMA-6 assigned to	: PCI/ISA PnP	F6 : Load BIOS Defaults	
DMA-7 assigned to	: PCI/ISA PnP	F7 : Load Setup Defaults	

PNP OS Installed

This field allows you to specify if the operating system installed in your system is plug and play aware.

NOTE: Operating systems such as DOS, OS/2, and Windows 3.x do not use PnP.

Resources Controlled by

This PnP BIOS can configure all of the boot and compatible devices automatically. However, this capability needs you to use a PnP operating system such as Windows 95. The default value is **Manual**.

Reset Configuration Data

This field allows you to determine whether to reset the configuration data or not. The default value is **Disabled**.

IRQ3/4/5/7/9/10/11/12/14/15, DMA0/1/3/5/6/7 assigned to

These fields allow you to determine the IRQ/DMA assigned to the ISA bus and is not available to any PCI slot.

Used MEM base addr

This field allows the user to set the base address and block size of a legacy (non-PnP) ISA card that uses any memory segment within the C800H and DFFFH address range. If the you have such a card and are not using an ICU (ISA Configuration Utility) to specify its address range, select a base address from the six available options. During selection, the “Used MEM Length” field will appear with the block size options. If you have more than one legacy ISA card in your system that require the use of this address range, you can increase the block size to either 8K, 16K, 32K or 64K. If you are using ICU to accomplish this task, leave “Used MEM base addr” to its default setting of *N/A*.

Load BIOS Defaults

This option allows you to load the troubleshooting default values permanently stored in the BIOS ROM. These default settings are non-optimal and disable all high-performance features.

ROM PCI/ISA BIOS
 CMOS SETUP UTILITY
 AWARD SOFTWARE, INC.

STANDARD CMOS SETUP	INTEGRATED PERIPHERALS
BIOS FEATURES SETUP	SUPERVISOR PASSWORD
CHIPSET FEATURES SETUP	USER PASSWORD
POWER MANAGEMENT	DETECTION
PNP/PCI CONFIGURATION	FORMAT
LOAD BIOS DEFAULTS	UP
LOAD SETUP DEFAULTS	EXIT WITHOUT SAVING
ESC : Quit	↑ ↓ → ← : Select Item
F10 : Save & Exit Setup	(Shift) F2 : Change Color
Load BIOS Defaults except Standard CMOS Setup	

To load BIOS defaults value to CMOS SRAM, enter “Y”. If not, enter “N”.

Load Setup Defaults

This option allows you to load the default values to your system configuration. These default settings are optimal and enable all high performance features.

ROM PCI/ISA BIOS
 CMOS SETUP UTILITY
 AWARD SOFTWARE, INC.

STANDARD CMOS SETUP	INTEGRATED PERIPHERALS
BIOS FEATURES SETUP	SUPERVISOR PASSWORD
CHIPSET FEATURES SETUP	USER PASSWORD
POWER MANAGEMENT	DETECTION
PNP/PCI CONFIGURATION	FORMAT
LOAD BIOS DEFAULTS	UP
LOAD SETUP DEFAULTS	EXIT WITHOUT SAVING
ESC : Quit	↑ ↓ → ← : Select Item
F10 : Save & Exit Setup	(Shift) F2 : Change Color
Load BIOS Defaults except Standard CMOS Setup	

To load SETUP defaults value to CMOS SRAM, enter “Y”. If not, enter “N”.

Integrated Peripherals

This option allows you to determine your hard disk configuration, mode and port.

ROM PCI/ISA BIOS
INTEGRATED PERIPHERALS
AWARD SOFTWARE INC.

IDE HDD Block Mode	: Enabled	Onboard FDD Controller	: Enabled
IDE Primary Master PIO	: Auto	Onboard Serial Port 1	: Auto
IDE Primary Slave PIO	: Auto	Onboard Serial Port 2	: Auto
IDE Secondary Master PIO	: Auto	Onboard UART 2 Mode	: Standard
IDE Secondary Slave PIO	: Auto		
IDE Primary Master UDMA	: Auto	Onboard Parallel Port	: 378H/IRQ7
IDE Primary Slave UDMA	: Auto	Parallel Port Mode	: Normal
IDE Secondary Master UDMA	: Auto		
IDE Secondary Slave UDMA	: Auto		
On-Chip Primary PCI IDE	: Enabled		
On-Chip Secondary PCI IDE	: Enabled		
USB Keyboard Support	: Disabled		

ESC : Quit ↑ ↓ ← : Select Item
F1 : Help PU/PD/+/- : Modify
F5 : Old Values (Shift) F2 : Color
F6 : Load BIOS Defaults
F7 : Load Setup Defaults

IDE HDD Block Mode

This field allows your hard disk controller to use the fast block mode to transfer data to and from your hard disk drive.

IDE Primary Master/Slave PIO and Secondary Master/Slave PIO

These fields allow your system hard disk controller to work faster. Rather than have the BIOS issue a series of commands that transfer to or from the disk drive, PIO (Programmed Input/Output) allows the BIOS to communicate with the controller and CPU directly.

The system supports five modes, numbered from 0 (default) to 4, which primarily differ in timing. When Auto is selected, the BIOS will select the best available mode.

IDE Primary Master/Slave UDMA and Secondary Master/Slave UDMA

This field allows your system to improve disk I/O throughput to 33Mb/sec with the Ultra DMA/33 feature. The options are *Auto* and *Disabled*.

On-Chip Primary/Secondary PCI IDE

These fields allow you either to enable or disable the Primary/Secondary controller. You might choose to disable the controller if you were to add a higher performance or specialized controller.

USB Keyboard Support

This field allows your system to support a USB keyboard.

Onboard FDD Controller

This option allows you to select the onboard FDD port.

Onboard Serial/Parallel Port

These fields allow you to select the onboard serial and parallel port and their addresses. The default value for these ports are:

Serial Port 1	3F8/IRQ4
Serial Port 2	2F8/IRQ3
Parallel Port	378H/IRQ7

UART 2 Mode

This field determines the UART 2 mode in your computer. The options are *Standard*, *HPSIR*, and *ASKIR*.

Parallel Port Mode

This field allows you to determine parallel port mode function.

Normal	Normal Printer Port
EPP	Enhanced Parallel Port
ECP	Extended Capabilities Port
ECP+EPP	Extended Capabilities Port or Enhanced Parallel Port

Supervisor / User Password

These two options set the system password. *Supervisor Password* sets a password that will be used to protect the system and Setup utility. *User Password* sets a password that will be used exclusively on the system. To specify a password, highlight the type you want and press <Enter>. The **Enter Password:** message prompts on the screen. Type the password, up to eight characters in length, and press <Enter>. The system confirms your password by asking you to type it again. After setting a password, the screen automatically returns to the main screen.

To disable a password, just press the <Enter> key when you are prompted to enter the password. A message will confirm the password to be disabled. Once the password is disabled, the system will boot and you can enter Setup freely.

ROM PCI/ISA BIOS
CMOS SETUP UTILITY
AWARD SOFTWARE, INC.

STANDARD CMOS SETUP	INTEGRATED PERIPHERALS
BIOS FEATURES SETUP	SUPERVISOR PASSWORD
CHIPSET FEATURES SETUP	USER PASSWORD
POWER MANAGEMENT SETUP	SMART DRIVE DETECTION
PNP/PCI CONFIGURATION	IDE CHAINING
LOAD BIOS DEFAULTS	FORMAT
LOAD SETUP DEFAULTS	UP
	SAVING
ESC : Quit	↑ ↓ → ← : Select Item
F10 : Save & Exit Setup	(Shift) F2 : Change Color
Change / Set / Disable Password	

IDE HDD Auto Detection

This option detects the parameters of an IDE hard disk drive, and automatically enters them into the Standard CMOS Setup screen.

ROM PCI/ISA BIOS
STANDARD CMOS SETUP
AWARD SOFTWARE, INC.

HARD DISKS	TYPE	SIZE	CYLS	HEAD	PRECOMP	LANDZ	SECTOR	MODE
Primary Master:								
Select Primary Master Option (N=SKIP) : N								
1 (Y)	0	0	0	0	0	0	0	NORMAL

NOTE: Some OSes (like SCO-UNIX) must use "NORMAL" for installation

Up to four IDE drives can be detected, with parameters for each appearing in sequence inside a box. To accept the displayed entries, press the "Y" key; to skip to the next drive, press the "N" key. If you accept the values, the parameters will appear listed beside the drive letter on the screen.

HDD Low Level Format

This option should only be used by a professional. Low-level formatting can cause irreparable damage to your hard disk. The procedures include selecting the drive you want to low-level format, determining the bad tracks, and proceeding with pre-formatting.

Save & Exit Setup

This option allows you to determine whether to accept the modifications or not. If you type “Y”, you will quit the setup utility and save all changes into the CMOS memory. If you type “N”, you will return to Setup utility.

ROM PCI/ISA BIOS
CMOS SETUP UTILITY
AWARD SOFTWARE, INC.

STANDARD CMOS SETUP	INTEGRATED PERIPHERALS
BIOS FEATURES SETUP	SUPERVISOR PASSWORD
CHIPSET FEATURES SETUP	USER PASSWORD
POWER MANAGEMENT SETUP	IDE HDD AUTO DETECTION
PNP/PCI CONFIGURATION	FORMAT
LOAD BIOS DEFAULTS	SETUP
LOAD SETUP DEFAULTS	SAVING
ESC : Quit	↑ ↓ → ← : Select Item
F10 : Save & Exit Setup	(Shift) F2 : Change Color
Save Data to CMOS & Exit Setup	

Exit Without Saving

Select this option to exit the Setup utility without saving the changes you have made in this session. Typing “Y” will quit the Setup utility without saving the modifications. Typing “N” will return you to Setup utility.

ROM PCI/ISA BIOS
CMOS SETUP UTILITY
AWARD SOFTWARE, INC.

STANDARD CMOS SETUP	INTEGRATED PERIPHERALS
BIOS FEATURES SETUP	SUPERVISOR PASSWORD
CHIPSET FEATURES SETUP	USER PASSWORD
POWER MANAGEMENT SETUP	IDE HDD AUTO DETECTION
PNP/PCI CONFIGURATION	FORMAT
LOAD BIOS DEFAULTS	SETUP
LOAD SETUP DEFAULTS	EXIT WITHOUT SAVING
ESC : Quit	↑ ↓ → ← : Select Item
F10 : Save & Exit Setup	(Shift) F2 : Change Color
Abandon all Data & Exit Setup	

4

VGA Driver Installation

This chapter provides information on how to install the VGA drivers that come in the floppy diskette with your CI5TTP card. Please follow the instructions set forth in this chapter carefully. Please note that there must be relevant software installed in your system before you could proceed to install the VGA drivers. It is recommended that you make a copy of the VGA driver diskette and put the backup copy in a safe place.

The following items are covered in this chapter:

Installing the Drivers for Windows 3.1.....	60
Driver Installation	60
Changing Display Drivers	60
Changing Color Schemes	60
Installing the Drivers for Windows 95.....	61
Driver Installation	61
Installing the Drivers for Windows NT 3.5x	62
Driver Installation	62
Installing the Drivers for Windows NT 4.0	63
Driver Installation	63

Installing the Drivers for Windows 3.1

Driver Installation

Included in your VGA Drivers diskette are drivers designed for Windows 3.1. To install the drivers, please follow the procedure below.

1. Run Windows as you would normally do to check if the operating system is working properly.
2. Insert the VGA Drivers diskette into your floppy disk drive which we will assume to be Drive A. In the Program Manager in Windows, choose **File** from the menu on top of the screen. From the pull-down menu, Choose **Run**. When prompted to enter the file to run, type **a:\windows\setup** and press <ENTER> or click **OK** to start the installation. The setup program then installs the drivers in the directory where the Windows program is. When the drivers are loaded, press <ENTER> to finish the installation. The Display Driver Control Panel appears when the installation is complete. It allows you to choose and load the installed display drivers.

Changing Display Drivers

Windows allows you to change your display drivers. To do so, select **Windows Setup** in the **Main** window. Then select **Change System Settings** in the **Option** menu. Click on the arrow at the end of the Display line to see the list of display drivers available. Click on the driver you want and click on the **OK** button. Follow the instructions to complete the change.

Changing Color Schemes

Windows also allows you to change the color scheme of your system. From the **Main** window, select the **Control Panel** and then the **Color** icon. The screen shows you the current color scheme. To change the current color configuration, select the color scheme you want and click the **OK** button.

Installing the Drivers for Windows 95

Driver Installation

The following section describes the normal display driver installation procedures for Windows 95. Use the following procedures when installing the display drivers for Windows 95.

1. Click Start, then Settings, then Control Panel.
2. Double click on "Display".
3. Select the "Settings" page, click the "Change Display Type" button.
4. Click the "Change" button in the "Adapter Type" area.
5. Click the "Have Disk" button and press "OK".
6. Specify the path to the new driver and press <ENTER>:

Example 1: Insert the drivers disk in the A: floppy drive, and enter
A:\win95.

Example 2: Type in the name of the directory where you copied the drivers, either on your local hard drive or on a network share.

Example 3: If you're not sure exactly where the drivers are, choose the "Browse..." button to find them.

7. The "Select Device" dialog box will appear. Select the adapter that corresponds to the one you installed in your machine and click OK.
8. Windows 95 will copy the display drivers to the proper directories on your system.
9. Continue choosing Close until asked to restart your machine from the "Systems Settings Change" dialog box.
10. After the system has restarted, you can go back into the Display applet and select alternate screen resolutions and color depths.

Installing the Drivers for Windows NT 3.5x

Driver Installation

The following section describes the VGA driver installation procedures for Windows NT 3.5x.

1. Run Windows NT Setup from Main Group
2. Choose Option from the menu (Alt-O)
3. Select Change System Setting (Alt-C)
4. Choose "Other" under the Display section
5. Insert display driver disk in appropriate floppy drive
6. Type the destination as "A:\NT35x"

Installing the Drivers for Windows NT 4.0

Driver Installation

Once you are in the Windows NT 4.0 environment, follow the procedures below to install the VGA drivers in the diskette that comes with your CPU card.

1. Click the Start button, then go to Settings and click on Control Panel.
2. Click on the Display icon to start the Display Properties window.
3. Click on the Settings tab, and then click on Display Type.
4. In the Change Display Type window, click on Change in Adapter Type. This will bring up the Select Device Window.
5. In the Change Display window, click on Have Disk. Follow the directions on the screen to supply the directory where the Windows NT driver files are located. Then select OK, or press ENTER.
6. Select Chips Video Accelerator from Display list provided, then click OK or press ENTER.
7. You will then see a warning panel about Third Party Drivers. Click on Yes to finish the installation.
8. Once the installation is complete, the system must be shut down and restarted for the new drivers to take effect.
9. When the system has restarted, the default graphics mode (usually 640x480x256color) has been automatically selected. Click the Start button, then go to Settings and click on Control Panel. Click on the Display icon to start the Display Properties window. Click on the Settings tab. A new screen setting can be selected using either of the following methods:
 - A. Use the slide-bar in the Desktop Area to select new setting.
 - B. Click on List All Modes. From the list provided, select a new setting, then click OK or press ENTER.
 - C. Click on Test to test the newly selected graphics mode. Follow the instructions given on the screen. A test screen should appear, followed by the Testing Mode window. Click on Yes to continue. Click on Apply to switch to the new graphics mode. Graphics modes are changed dynamically on NT 4.0, so you do not need to shut down and restart for the new screen settings to work.

This page is intentionally left blank.

5

Intel PIIX Bus Master IDE Driver Installation

This chapter describes the installation procedure for Intel PIIX Bus Master IDE Drivers for Windows 95.

This chapter contains the following sections:

System Requirements	66
Installing the Software	67

System Requirements

This section describes system requirements for the PIIX Bus Master IDE Device Driver for Windows 95*. This driver has been designed for and tested with Windows 95 only. This driver will only install on systems with Windows 95.

1. The system must contain a supported Intel processor and chipset configuration.
2. Ensure that a mouse is connected to the system.
3. One of the following versions of Windows 95* must be installed on the system prior to running utility program.

Windows 95* 4.00.950 (Retail)

Windows 95* 4.00.950a (OSR1)

Windows 95* 4.00.950b (OSR2 without USB Supplement)

Windows 95* 4.00.950b (OSR2.1 with USB Supplement)

4. This utility should only be used on desktop systems. The utility must not be executed on notebook or portable systems with or without dock.
5. It is assumed that the BIOS properly initialized the 82371xB IDE interface for Bus Master IDE operation.
6. There are no other non-82371xB IDE controllers (add-in IDE controller or sound card with IDE) enabled on the system.

Installing the Software

This subsection describes how to install the software on a system where Windows 95 is installed.

***NOTE:** Record the location of the Windows 95* directory before installing the driver.*

1. Check the System Requirements. Windows 95* must be fully installed and running on the system prior to running this software.
2. Close any running applications.
3. Remove references to installed real-mode IDE device drivers in the AUTOEXEC.BAT and CONFIG.SYS files (especially any drivers that control ATAPI CD-ROM and special IDE features). Use the Notepad utility to do this.

The driver files are stored in an integrated application setup program.

This program is a Windows 95* program that allows the driver files to be INSTALLED or DE-INSTALLED.

Execute the driver setup program.

Run SETUP.EXE.

4. Click 'Next' on Welcome Screen to read and agree to the license agreement. View the text file and choose File\Exit to close Notepad and continue. ***NOTE:** If you click 'No', program will terminate.*
5. Click 'Yes' if you agree to continue. ***NOTE:** If you click 'No', the program will terminate.*
6. Select 'INSTALL', to install the PIIX Bus Master IDE Device Driver when prompted to do so.

***NOTE:** If the driver is currently installed on the system, SETUP will ask you whether or not you want to continue. Follow the prompts on the screen to Install the driver if desired.*

7. Click 'OK' to restart the system when prompted to do so.
8. Follow the screen instructions and use default settings to complete the setup when Windows 95* is re-started. Upon re-start, Windows 95* will display that it has found an Intel PCI Bus Master IDE controller hardware and is installing hardware for it.

If a "New Hardware Found" dialog box is displayed requesting the location of the drivers, use the mouse to click on the scrollbar and click on the <Windows 95* directory>\System\IOSubSys path:

For example:

Click on 'C:\WINDOWS\SYSTEM\IOSUBSYS\'

Click 'OK'.

9. Select 'Yes', when prompted to re-start Windows 95.

NOTE: After installation, the following driver and related files are stored as listed.

<Windows 95* directory>\System\IOSubSys\IDEATAPI.MPD

<Windows 95* directory>\System\IOSubSys\PIIXVSD.VXD

<Windows 95* directory>\INF\IDEATAPI.INF

6

System Monitor User's Guide

This chapter introduces System Monitor Utility that comes with the motherboard in conjunction with the onboard hardware monitoring IC. The sections in the following pages give the functions of the utility.

System Monitor is a utility software that oversee the general performance of systems, covering areas like system temperature, system voltage, CPU and system fan rotational speeds. If conditions become adversed, that is, when voltages are erratic or CPU temperature exceeds the safe limits, an alarm will be sounded; thereby preventing system crashing and ensuring overall stability.

***NOTE:** System Monitor currently supports English and Chinese under Windows 95 and Windows NT. English will be used for other language environments.*

When System Monitor is initiated, the icon below appears in the task bar in the Windows environment.



The following screen appears upon clicking on the System Monitor icon.



Clicking on the upper left corner button would show you the latest company information. "Summary" provides the current system status.

The section below describes the different functions of System Monitor.

1. Computer - displays the current working system version and processor type.

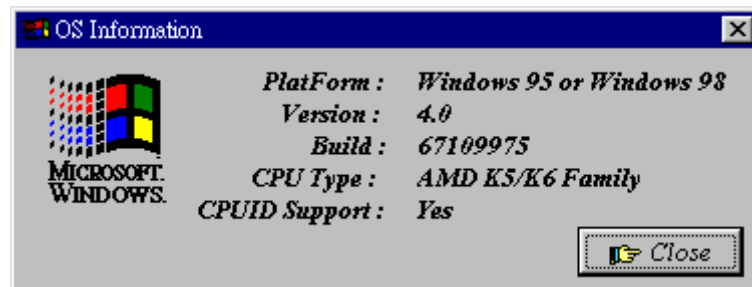

2. Power - displays the current voltage status.

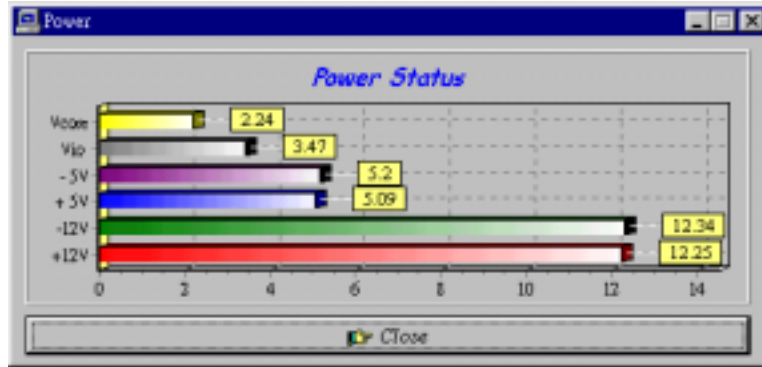

3. Memory - displays the current memory usage status.

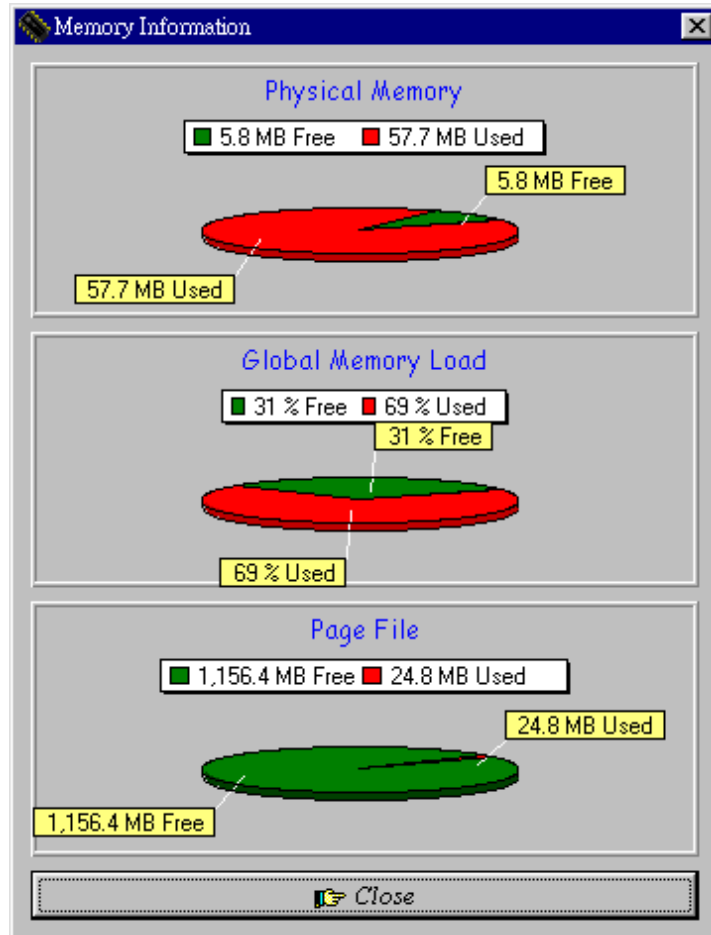

- Fan Speed - displays the current rotational speeds of CPU and Chassis fans.

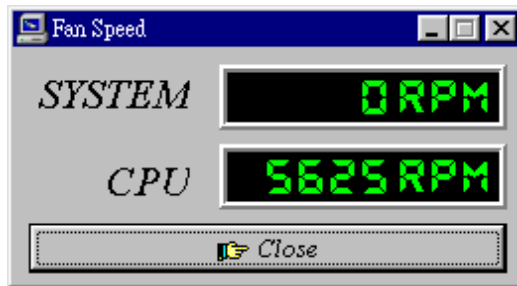

- Disk - displays the disk supported formats and disk space.

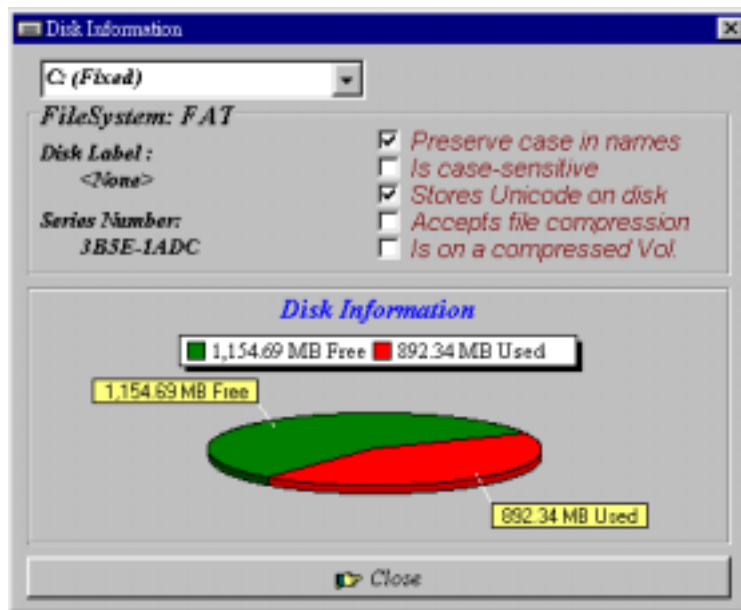

- Heat - displays the CPU and system temperatures.

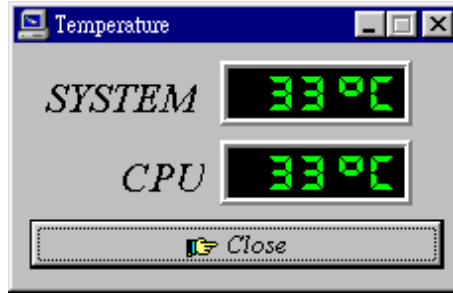

- Error Log - displays errors occurring after System Monitor is started.

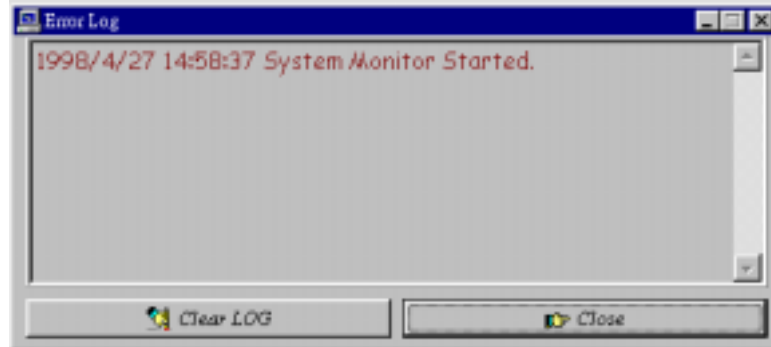

8. Setting - sets the values at which an alarm is sounded.

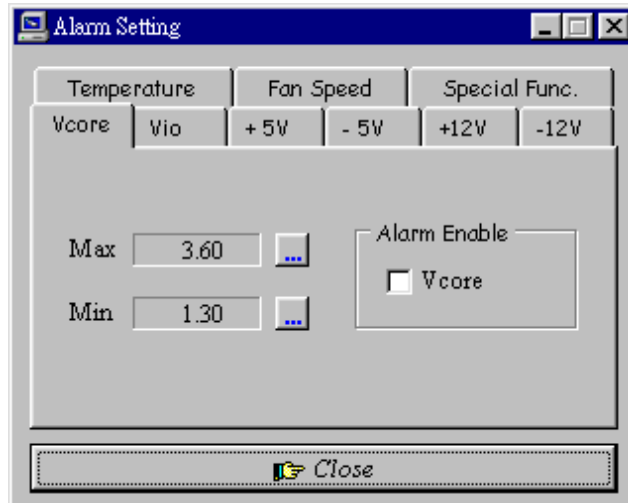

Voltage : the acceptable voltage range between the "MAX"
Temperature : temperature threshold.
Fan Rotation Speed : the minimum rotation speed.

NOTE: Intel has defined a margin of difference for the voltages as below:
12 Volts - 10% (10.8V ~ 13.2V)
5 Volts - 5% (4.75 ~ 5.25%)
Vio - 5% (Vio for P54C CPU is 3.5V. Vio for P55C is 3.3V.)
Vcore- 5%

7

LANDesk User's Guide

This chapter gives a brief introduction to the optional LANDesk® Client Manager (LDCM) utility, as well as the installation procedures.

The following items are covered in this chapter:

Introduction to LDCM.....	78
LDCM Installation.....	79
Installing the Local Version of LDCM	80
Installing the Administrator Version of LDCM	82

Introduction to LDCM

LANdesk Client Manager (LDCM 3.1) provides the capability for managing components (network interface cards, memory, printers, software applications, etc.) within a PC system. It uses the Desktop Management Interface (DMI) standard established by the Desktop Management Task Force (DMTF). Manageable components can be viewed, monitored, and administrated across multiple platforms, either locally or remotely on a network.

The LDCM package has been implemented in two different ways: a user (client/local) version and an administrator version (Remote Companion). The user version provides the ability to only manage the local PC. The administrator version allows a network administrator to manage the local PC and other PC nodes on the network. This means that the administrator version has the ability to gather information about remote PCs, as well as remotely controlling the PCs. The remote access is based upon granted rights by the managed client.

LDCM provides the user with self-help diagnostics, including a PC health meter, local alerting of potential problems, and hardware and software inventory. Automatic polling and alerting of memory and hardware conditions and predictive failure mechanisms minimize downtime and increase effective troubleshooting. LDCM can take periodic "snapshots" of critical configuration files for easy change management and restoration when needed.

To use LDCM, your computer must meet the following requirements:

- Operating System: Windows 95, Windows NT 3.51, or Windows NT4.0
- Memory: about 200KB
- Disk Storage Space: 3-5MB
- Hardware System: a DMI BIOS is required for full LDCM functionality

For network computers, the following requirements also apply:

- Protocols: IPX or IP (WinSock-enabled) communication protocol loaded on the client
- Hardware Interfaces: a network card for communication on the network

LDCM Installation

The optional LANDesk utility that comes with the CPU card runs in Windows NT or Windows 95 operating system.

Upon entering the Windows NT 4.0 or Windows 95 environment, insert the CD. Windows will autorun the installation program and show the following screen.



NOTE: During Setup, you will be asked to install Internet Explorer 3.02 in order to continue, or else Setup will be aborted. LDCM supports various languages and will default to English if it is unable to load the language dll.

Installing the Local Version of LDCM

Double Click on 'LANdesk Client Manager' in the initial screen and the following screen will appear. Double click on the local version of LANdesk Client Manager.



When the Welcome screen appears, click on "Next" to continue with Setup.

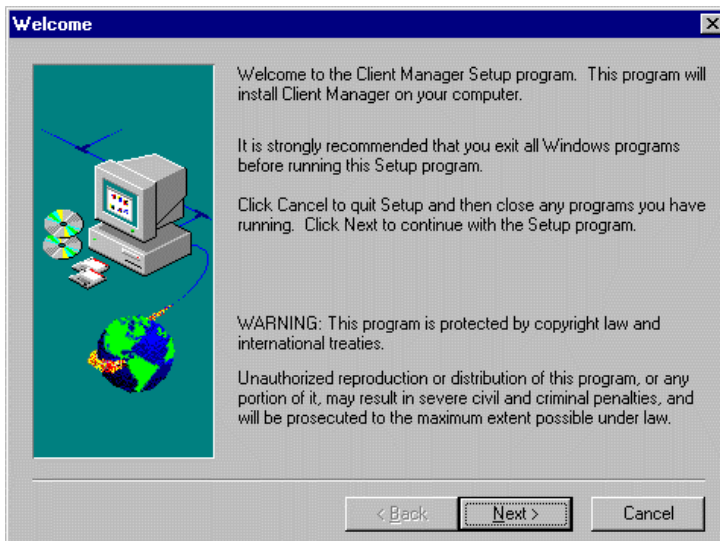

Choose the directory location where Setup will install LANdesk Client Manager. Click "Browse" if you want to change the directory suggested. Otherwise, click "Next" to start installing LDCM.

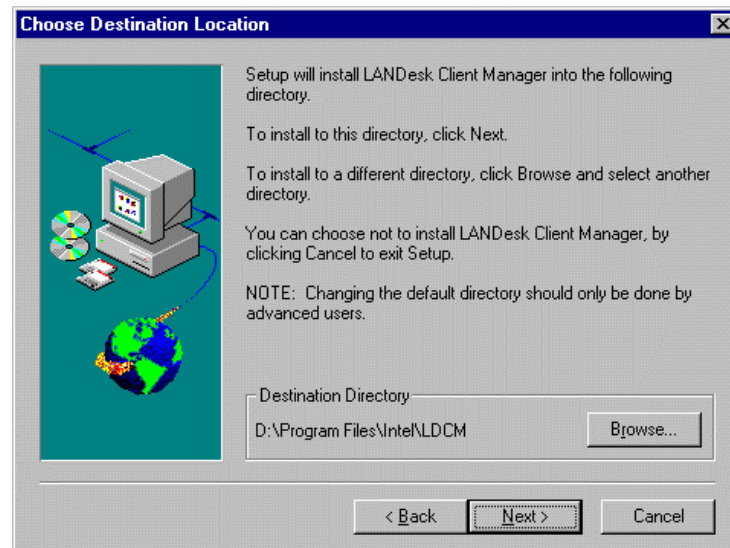

When Setup is finished, changes will have been made to the file AUTOEXEC.BAT. Restart your computer for the changes to take effect.

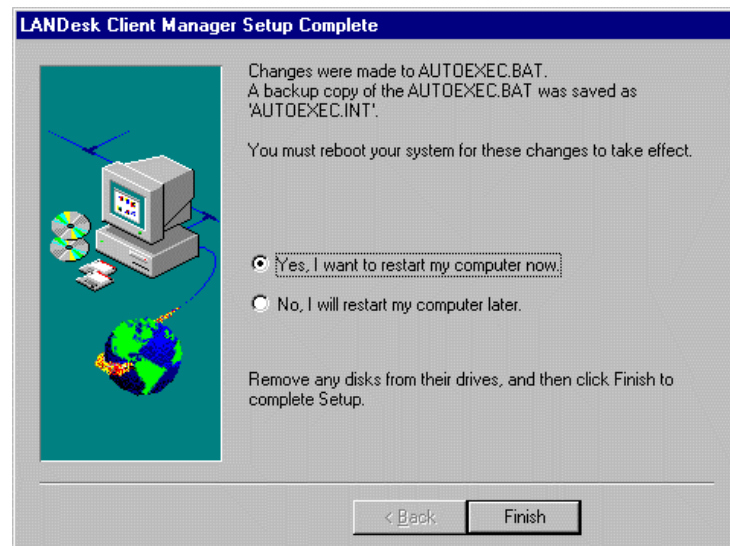

Installing the Administrator Version of LDCM

After double clicking on 'LANDesk Client Manager' in the initial screen, select the administrator version of the LDCM and the Welcome screen below will appear. Click on "Next" to continue.

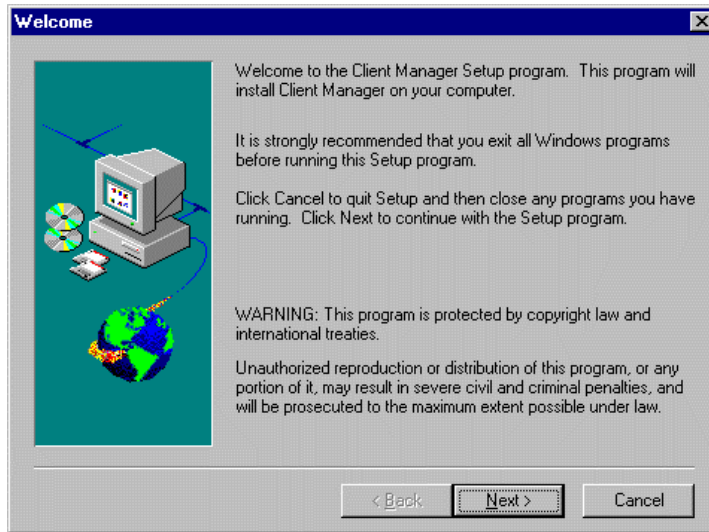

The screen below allows you to install the documentation in Adobe Acrobat format and the Adobe Acrobat Reader software. Select the options you need and click on "Next" to start the installation.



After LANdesk Client Manager Setup is complete, restart your computer to be able to use the LANdesk Client Manager.

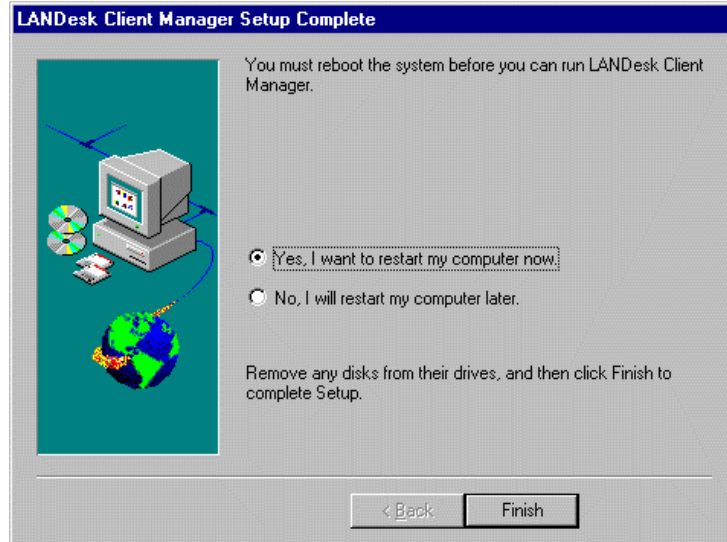

This page is intentionally left blank.

Appendix

A. I/O Port Address Map

B. Interrupt Request Lines (IRQ)

A. I/O Port Address Map

Each peripheral device in the system is assigned a set of I/O port addresses which also becomes the identity of the device. There are a total of 1K port address space available. The following table lists the I/O port addresses used on the Industrial CPU Card.

Address	Device Description
000h - 01Fh	DMA Controller #1
020h - 03Fh	Interrupt Controller #1
040h - 05Fh	Timer
060h - 06Fh	Keyboard Controller
070h - 07Fh	Real Time Clock, NMI
080h - 09Fh	DMA Page Register
0A0h - 0BFh	Interrupt Controller #2
0C0h - 0DFh	DMA Controller #2
0F0h	Clear Math Coprocessor Busy Signal
0F1h	Reset Math Coprocessor
1F0h - 1F7h	IDE Interface
278 - 27F	Parallel Port #2(LPT2)
2F8h - 2FFh	Serial Port #2(COM2)
2B0 - 2DF	Graphics adapter Controller
378h - 3FFh	Parallel Port #1(LPT1)
360 - 36F	Network Ports
3B0 - 3BF	Monochrome & Printer adapter
3C0 - 3CF	EGA adapter
3D0 - 3DF	CGA adapter
3F0h - 3F7h	Floppy Disk Controller
3F8h - 3FFh	Serial Port #1(COM1)

B. Interrupt Request Lines (IRQ)

There are a total of 15 IRQ lines available on the Industrial CPU Card. Peripheral devices use interrupt request lines to notify CPU for the service required. The following table shows the IRQ used by the devices on the Industrial CPU Card.

Level	Function
IRQ0	System Timer Output
IRQ1	Keyboard
IRQ2	Interrupt Cascade
IRQ3	Serial Port #2
IRQ4	Serial Port #1
IRQ5	Parallel Port #2
IRQ6	Floppy Disk Controller
IRQ7	Parallel Port #1
IRQ8	Real Time Clock
IRQ9	Software Redirected to Int 0Ah
IRQ10	Reserved
IRQ11	Reserved
IRQ12	Reserved
IRQ13	80287
IRQ14	Primary IDE
IRQ15	Secondary IDE