



SY-7IWB

Motherboard

Socket 370 Celeron™ Processor supported

FW82810 AGP/PCI/AMR

66/100 MHz Front Side Bus supported

Baby AT Form Factor

User's Manual

Copyright © 1999 by Soyo Computer Inc.

Trademarks:

Soyo is the registered trademark of Soyo Computer Inc. All trademarks are the properties of their owners.

Product Rights:

All names of the product and corporate mentioned in this publication are used for identification purposes only. The registered trademarks and copyrights belong to their respective companies.

Copyright Notice:

All rights reserved. This manual has been copyrighted by Soyo Computer Inc. No part of this manual may be reproduced, transmitted, transcribed, translated into any other language, or stored in a retrieval system, in any form or by any means, such as by electronic, mechanical, magnetic, optical, chemical, manual or otherwise, without permission in writing from Soyo Computer Inc.

Disclaimer:

Soyo Computer Inc. makes no representations or warranties regarding the contents of this manual. We reserve the right to amend the manual or revise the specifications of the product described in it from time to time without obligation to notify any person of such revision or amend. The information contained in this manual is provided to our customers for general use. Customers should be aware that the personal computer field is subject to many patents. All of our customers should ensure that their use of our products does not infringe upon any patents. It is the policy of Soyo Computer Inc. to respect the valid patent rights of third parties and not to infringe upon or to cause others to infringe upon such rights.

Restricted Rights Legend:

Use, duplication, or disclosure by the Government is subject to restrictions set forth in subparagraph (c)(1)(ii) of the Rights in Technical Data and Computer Software clause at 252.277-7013.

About This Guide:

This Quick Start Guide can help system manufacturers and end users in setting up and installing the Motherboard. Information in this guide has been carefully checked for reliability; however, to the correctness of the contents there is no guarantee given. The information in this document is subject to amend without notice.

For further information, please visit our **Web Site** on the Internet. The address is "<http://www.soyo.com.tw>".

Edition: July 1999
Version 1.0
7IWB SERIAL

FC Tested To Comply
With FCC Standards
FOR HOME OR OFFICE USE

100% POST CONSUMER
RECYCLED PAPER

Table of Contents

CHAPTER 1 MOTHERBOARD DESCRIPTION	1
1-1 INTRODUCTION	1
1-2 KEY FEATURES	1
1-3 HANDLING THE MOTHERBOARD	3
1-4 ELECTROSTATIC DISCHARGE PRECAUTIONS	3
1-5 SY-7IWB MOTHERBOARD LAYOUT	4
1-6 SY-7IWB MOTHERBOARD COMPONENTS	5
1-7 CHIPSET	7
1-8 I/O INTERFACE CONTROLLER	13
1-9 AUDIO SUBSYSTEM	15
1-10 HARDWARE MONITOR	15
1-11 WAKE ON LAN TECHNOLOGY	15
CHAPTER 2 HARDWARE INSTALLATION	17
2-1 PREPARATIONS	17
2-2 UNPACKING THE MOTHERBOARD	18
2-3 INSTALLATION GUIDE	19
2-3.1 CPU Installation	20
2-3.2 SDRAM Memory Module Installation	22
2-3.3 Motherboard Connector	24
2-3.4 Jumper Setting	40
2-3.5 CMOS Clearing (JP5)	43
2-3.6 Power On	43
2-3.7 Quick BIOS Setup	44
2-3.8 Troubleshooting at First Start	46
2-3.9 Power Off	47
CHAPTER 3 BIOS SETUP UTILITY	48
3-1 SOYO COMBO SETUP	51
3-2 STANDARD CMOS SETUP	55
3-3 ADVANCED BIOS FEATURES	58



3-4	ADVANCED CHIPSET FEATURES	62
3-5	INTEGRATED PERIPHERALS	64
3-6	POWER MANAGEMENT SETUP	69
3-7	PNP/PCI CONFIGURATION SETUP.....	72
3-8	PC HEALTH STATUS.....	75
3-9	LOAD OPTIMIZED DEFAULTS.....	77
3-10	LOAD FAIL-SAFE DEFAULTS.....	78
3-11	SUPERVISOR PASSWORD.....	79
3-12	USER PASSWORD.....	80
3-13	IDE HDD AUTO DETECTION	81
CHAPTER 4 DRIVERS INSTALLATION		82
CHAPTER 5 CRYSTAL AUDIO DRIVER INSTALLATION.....		87

Chapter 1

MOTHEBOARD DESCRIPTION

1-1 INTRODUCTION

The **SY-7IWB** AGP/PCI/AMR Motherboard is a high-performance Socket 370 processor supported Baby AT form-factor system board. **SY-7IWB** uses the FW82810 Chipset technology and supports Socket 370 processors. This Motherboard is fully compatible with industry standards and adds many technical enhancements.

1-2 KEY FEATURES

- Supports Intel Celeron™processors (300A-500MHz)
- Supports 100 & 66 MHz Front Side Bus Frequency
- Auto detect CPU bus Frequency (66/100)
- Auto-detect CPU voltage
- Adjustable CPU Core Voltage (Normal, 5%)
- Chipset integrated 3D AGP Accelerator
- Easy CPU settings in BIOS with the “SOYO COMBO Setup”
- Software Audio AC97 Version 2.1 Compliant
- PC98, ACPI, Ultra DMA33
- Supports Wake-On-LAN (WOL) when use ATX-Power supply
- Supports ACPI Suspend Indicator
- Power-on by modem, alarm, PS/2 Keyboard, Mouse and USB Win98 Keyboard

- Power failure resume
- Supports onboard hardware monitoring and includes Hardware Doctor™ utility
- Fan speed control
- Battery Low voltage Detect
- Support 7 sets of voltage monitoring
- Supports multiple-boot function
- Y2K Compliant
- Supports Audio Modem Riser slot (AMR 1.0 compliant) *
- 3 x 32-bit bus mastering PCI slots
- 2 x USB ports onboard
- 1 x IrDA port
- AT power connector
- ATX power connector
- Hardware Random Number Generator (RNG) for enabling enhanced platform security
- RTC hardware to handle Y2K Century Rollover



** If the user wants to use a Modem Riser card (MR) make sure to use a **Secondary** mode MR, **PRIMARY** mode MRs are **NOT** Supported.*

1-3 HANDLING THE MOTHERBOARD

To avoid damage to your Motherboard, follow these simple rules while unpacking:

- Before handling the Motherboard, ground yourself by grasping an unpainted portion of the system's metal chassis.
- Remove the Motherboard from its anti-static packaging. Hold the Motherboard by the edges and avoid touching its components.
- Check the Motherboard for damage. If any chip appears loose, press carefully to seat it firmly in its socket.



Warning: Do not apply power if the Motherboard appears damaged. If there is damage to the board, contact your dealer immediately.

1-4 ELECTROSTATIC DISCHARGE PRECAUTIONS

Make sure to ground yourself before handling the Motherboard or other system components. Electrostatic discharge can easily damage the components. Note that you must take special precautions when handling the Motherboard in dry or air-conditioned environment.

To protect your equipment from electrostatic discharge, take the following precautions:

- Do not remove the anti-static packaging until you are ready to install.
- Ground yourself before removing any system component from its protective anti-static packaging. (To ground yourself, grasp the expansion slot covers or other unpainted portions of the computer chassis.)
- Frequently ground yourself while working or use a grounding strap.
- Handle the Motherboard by its edges and avoid touching its components.

1-5 SY-7IWB MOTHERBOARD LAYOUT

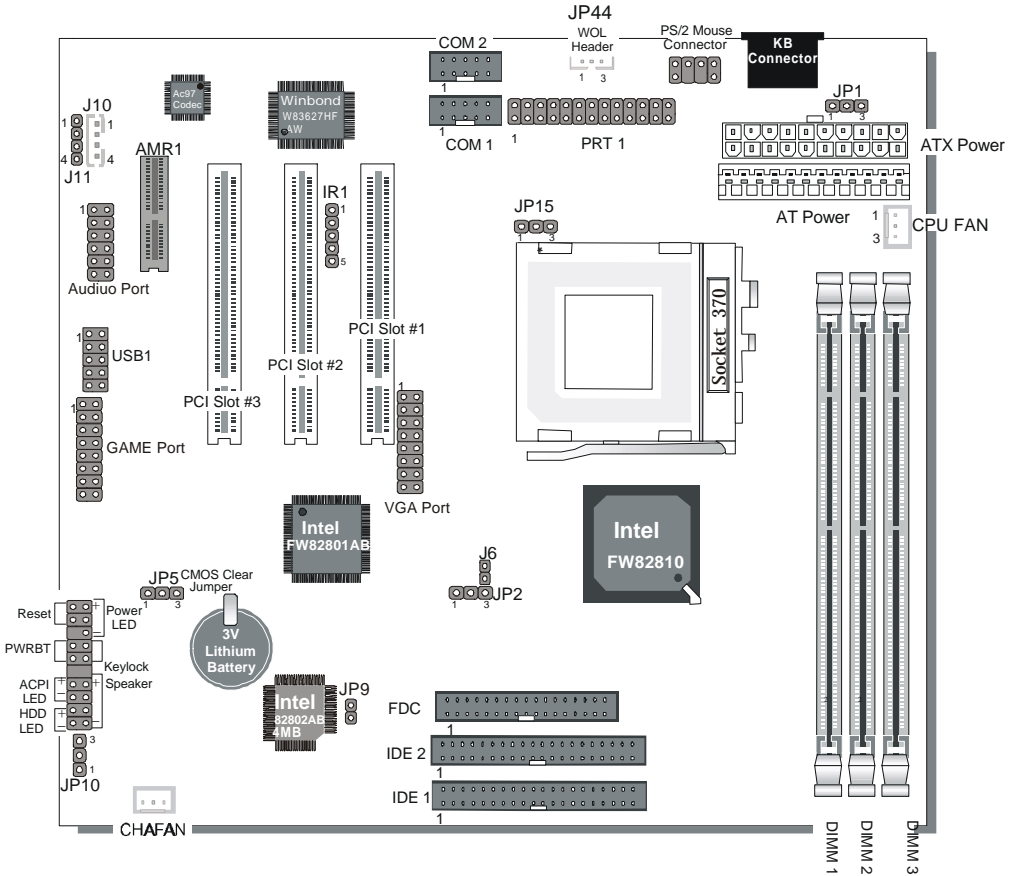

SY-7IWB Platform

1-6 SY-7IWB MOTHERBOARD COMPONENTS

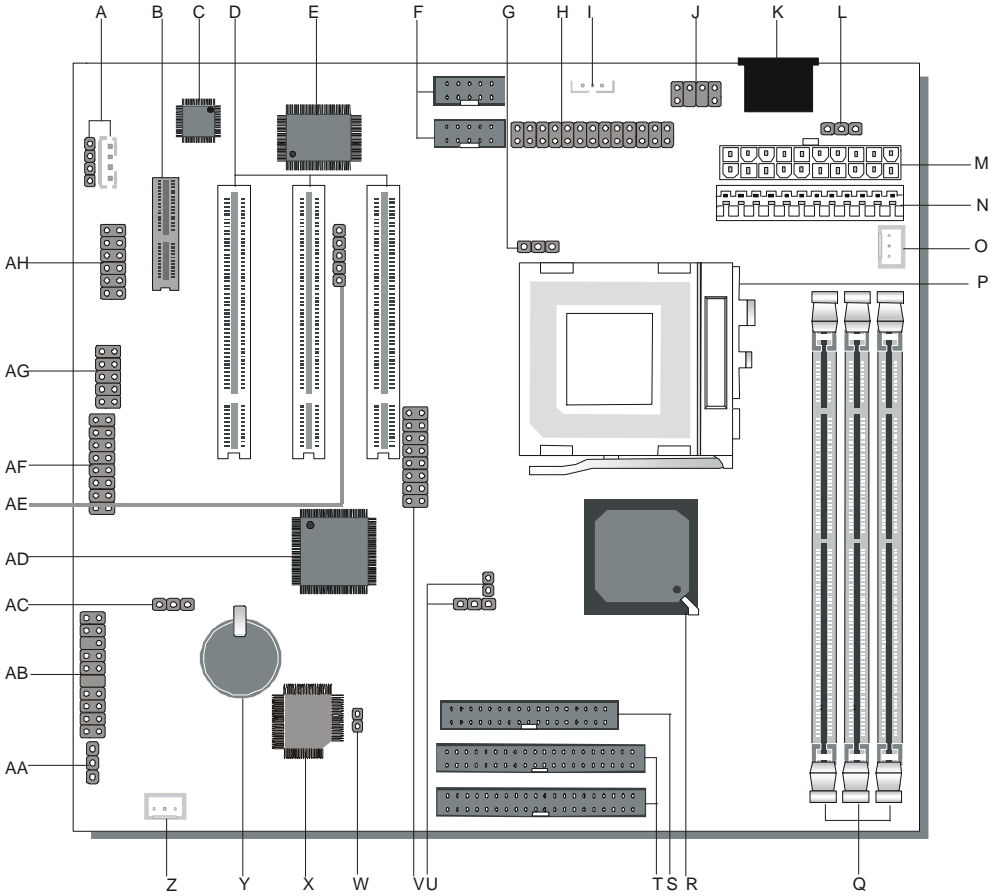

- A** CD-IN Connectors
- B** Audio Modem Riser Slot
- C** AC97 Codec Chip
- D** 32-bit PCI Mastering Slots
- E** Winbond W83627HF-AW LPC I/O Chip
- F** COM1/COM2 Connectors
- G** CPU Core Voltage Adjust Jumper
- H** Parallel Printer Port
- I** Wake-On-LAN(WOL) Header
- J** PS/2 Mouse Connector
- K** Keyboard Connector
- L** Power-On by Keyboard Jumper
- M** ATX power Supply Connector
- N** AT Power Supply Connector
- O** CPU Cooling Fan Connector
- P** PGA370 Socket
- Q** DIMM Bank
- R** Intel FW82810 GMCH (Graphic Memory Control Hub) Chip
- S** Floppy Disk Drive (FDD) Port
- T** Bus Mastering E-IDE/ATAPI Ports
- U** CPU FSB Configuration Jumpers
- V** VGA Port
- W** The FWH Boot Block Write-Protect Jumper
- X** Intel 82802AB 4MB FWH (FirmWare Hub) Chip
- Y** 3V Lithium Battery
- Z** Chassis Cooling Fan Connector
- AA** PC speaker redirection Jumper
- AB** Front panel connectors
- AC** CMOS Clear Jumper
- AD** Intel FW82801 ICH (I/O Control Hub) Chip
- AE** Serial Infrared (IrDA) Device Header
- AF** Game Port
- AG** Universal Serial Bus Port
- AH** Audio Port

1-7 CHIPSET

To compliment the Intel® Celeron processor, the Intel® 810 chipsets delivers a balanced platform solution for value computing. The 810 chipset is a highly-integrated three-chip solution consisting of a Graphics & Memory Controller (Intel 82810), an I/O Controller (Intel82801), and a Firmware Hub (Intel 82802).

The ICH is a highly integrated multifunctional I/O Controller Hub that provides the interface to the PCI Bus and integrates many of the functions needed in today PC platforms. The ICH communicates with the host controller over a dedicated hub interface. There are two versions of the ICH (82801AA: ICH and 82801AB: ICH0). These devices are pin compatible and are in 241-pin packages.

The Intel® 82802 Firmware Hub (FWH) component is part of the Intel® 810 chipset. The FWH is key to enabling future security and manageability infrastructures for the PC platform.

Intel has developed technology that enhances the performance and exceptional value of the Intel® Celeron™ processor-powered PC. Built on the strong foundation of Intel® 440BX AGPset technology, the Intel® 810 chipset has re-engineered the Value PC, providing next generation features and great graphics performance at a lower cost.

Richer, more robust 2D and 3D graphics are optimized thanks to an integrated chipset design that utilizes second-generation graphics technology. This integrated chipset offers innovative features with compelling performance while lowering overall system costs.

A new design with big benefits

At the core of the 810 chipset is a memory controller with built-in graphics

technology. The 82810 chip optimizes system memory arbitration, similar to AGP technology, resulting in a more responsive and cost-effective system.

The 82810 Graphics Memory Controller Hub (GMCH) features Intel® graphics technology and software drivers, using Direct AGP (integrated AGP) to create vivid 2D and 3D effects and images. The 82810 chip features integrated Hardware Motion Compensation to improve soft DVD video quality and a digital video out port that enables connection to traditional TVs or the new space-saving digital flat panel displays.

Intel® Dynamic Video Memory Technology (D.V.M.T.) is an architecture that offers breakthrough performance for the Value PC segment through efficient memory utilization and Direct AGP. The system OS uses the Intel software drivers and intelligent memory arbiter to support richer graphics applications.

The System Manageability Bus allows networking equipment to monitor the 810 chipset platform. Using ACPI specifications, the system manageability function enables low-power sleep mode and conserves energy when the system is idle.

The 82801 I/O Controller Hub (ICH) employs the Intel® Accelerated Hub Architecture to make a direct connection from the graphics and memory to the integrated AC97 controller, the IDE controllers, dual USB ports, and PCI add-in cards.

The Accelerated Hub Architecture provides twice the bandwidth of the PCI bus at 266 MB per second. This allows a wider flow of rich information from the I/O controller to the memory controller, with optimized arbitration rules allowing more functions to run concurrently, enabling more life-like audio and video.

The Integrated Audio-Codec 97 controller enables software audio and modem by using the processor to run sound and modem software. By reusing existing system resources, this feature adds flexibility, and improves sound quality.

The 82802 Firmware Hub (FWH) stores system BIOS and video BIOS, eliminating a redundant nonvolatile memory component. In addition, the 82802 contains a hardware Random Number Generator (RNG). The Intel® RNG provides truly random numbers to enable fundamental security building blocks supporting stronger encryption, digital signing, and security protocols.

Intel® 810 chipset re-engineers the Value PC by providing a platform that will bring next generation features and great graphics performance to Value PC while reducing overall platform cost.

PRODUCT HIGHLIGHTS

- Enhances performance and exceptional value of the Intel® Celeron™ processor-powered PC
- Built on strong foundation of Intel® 440Bx technology
- Provides next generation features
- Provides great graphics performance at a lower cost
- Optimizes 2D and 3D graphics through integrated chipset design utilizing second-generation graphics technology
- Innovative features with compelling performance while lowering system costs

FEATURES BENEFITS

- Intel® Accelerated Hub Architecture Increased I/O performance allows better concurrency for richer multimedia applications
- Integrated graphics/AC97 controller, more flexibility and better audio quality

- Intel® 3D graphics with Direct AGP Vivid 2D and 3D graphics, efficient use of system memory for graphics, O/S and applications
- Optional 4MB of dedicated display cache video memory Enables SKU differentiation with increased 3D graphics performance improvement over Direct AGP
- Low-power sleep modes Energy Savings
- One software driver code base More stable platform, higher quality graphics, reduced OEM support costs
- Intel® Random Number Generator (RNG) Enables ISV's to strengthen security products
- Digital Video Out port Allows connection of traditional TV or new digital flat panel displays; compatible with DVI specification
- Soft DVD MPEG 2 playback with Hardware Motion Compensation Life-like video and audio
- 100-MHz System Bus capable Flexibility for performance headroom
- 2 USB ports Plug and Play
- Multiple Intel® 810 chipset SKUs for Value PC price points Lower platform and manufacturing costs with single motherboard design

Product Package

- 82810 Graphics Memory Controller Hub 421 Ball Grid Array (BGA)
- 82801 Integrated Controller Hub 241 Ball Grid Array (BGA)
- 82802 Firmware Hub 32-pin PLCC or 40-pin TSOP

1-7.1 Accelerated Graphics Port (A.G.P.)

A.G.P. is a high-performance bus for graphics-intensive applications, such as 3D applications. A.G.P., while based on the PCI Local Bus Specifications, Rev 2.1, is independent of the PCI bus and is intended for exclusive use with graphical display devices. A.G.P. overcomes certain limitations of the PCI bus related to handling a large amount of graphics data with the following features:

- Pipelined memory read and write operations that hide memory access

latency

- Demultiplexing of address and data on the bus for near 100 percent bus efficiency
- AC timing for 133 MHz data transfer rates, allowing real data throughput in excess of 500 MB/sec

1-7.2 Universal Serial Bus (USB)

The motherboard has two USB ports; one USB peripheral can be connected to each port. For more than two USB devices, an external hub can be connected to either port. The motherboard fully supports the universal host controller interface (UHCI) and used UHCI-compatible software drivers.

Specification USB features include:

- Self-identifying peripherals that can be plugged in while the computer is running
- Automatic mapping of function to driver and configuration
- Support for isochronous and asynchronous transfer types over the same set of wires
- Support for up to 127 physical devices
- Guaranteed bandwidth and low latencies appropriate for telephony, audio, and other applications
- Error-handling and fault-recovery mechanisms built into the protocol

Note

Computer systems that have an unshielded cable attached to a USB port may not meet FCC Class B requirements, even if no device or a low-speed USB device is attached to the cable. Use shielded cable that meets the requirements for a full-speed USB device.

1-7.3 IDE Support

The motherboard has two independent bus-mastering PCI IDE interfaces. These interfaces support PIO Mode3, PIO Mode 4, ATAPI devices (e.g., CD-ROM), and Ultra DMA/33 synchronous-DMA mode transfers. The BIOS supports logical block addressing (LBA) and extended cylinder head sector (ECHS) translation modes. The BIOS automatically detects the IDE device transfer rate and translation mode.

Programmed I/O operations usually require a substantial amount of processor bandwidth. However, in multitasking operating systems, the bandwidth freed by bus mastering IDE can be devoted to other tasks while disk transfers are occurring.

The motherboard also supports laser servo (LS-120) drives. LS-120 technology allows the user to perform read/write operations to LS-120 (120MB) and conventional 1.44MB and 720KB diskettes. An optical servo system is used to precisely position a dual-gap head to access the diskette's 2,490 tracks per inch (tpi) containing up to 120 MB of data storage. A conventional diskette uses 135 tpi for 1.44 MB of data storage. LS-120 drives are ATAPI-compatible and connect to the motherboard's IDE interface. (LS-120 drives are also available with SCJSI and parallel port interfaces.) Some versions of Windows 95 and Windows NT operating systems recognize the LS-120 drive as a bootable device in both 120 MB and 1.44 MB mode.

Connection of an LS-120 drive and a standard 3.5-inch diskette drive is allowed. The LS-120 drive can be configured as a boot device if selected as Drive A in the BIOS setup program.

Note

If you connect an LS-120 drive to an IDE connector and configure it as the :boot: drive and configure a standard 3.5-inch diskette drive as a "B" drive, the standard diskette drive is not seen by the operating system.

When the LS-120 drive is configured as the "boot: device, the system will recognize it as both the A and B drive

1-7.4 Real-Time Clock, CMOS SRAM, and Battery

The real-time clock is compatible with DS1287 and MC146818 components. The clock provides a time-of-day clock and a multicentury calendar with alarm features and century rollover. The real-time clock supports 256 bytes of battery-backed CMOS SRAM in two banks that are reserved for BIOS use.

The time, date, and CMOS values can be specified in the Setup program. The CMOS values can be returned to their defaults by using the Setup program.

1-8 I/O INTERFACE CONTROLLER

The motherboard uses the Winbond W83627HF-AW I/O controller which features:

- Single diskette drive interface
- Two serial ports
- FIFO supports on both serial and diskette interfaces
- One parallel port with Extended Capabilities Port (ECP) and Enhanced Parallel Port (EPP) support
- PS/2 style mouse and keyboard interfaces
- PCI PME interface
- Intelligent auto power management, including:
 - Shadowed write-only registers for ACPI compliance
 - Programmable wake-up event interface

The Setup program provides configuration option for the I/O controller.

1-8.1 Serial Ports

The NS16C5450-compatible UARTs support data transfers at speeds up to 115.2 Kbits/sec with BIOS support.

1-8.2 Parallel Port

In the Setup program, there are four options for parallel port operation:

- Compatible (standard mode)
- Bi-directional (PS/2 compatible)
- Bi-directional EPP. A driver from the peripheral manufacturer is

required for operation. See Section 6.2 for EPP compatibility.

- Bi-directional high-speed ECP

1-8.3 Diskette Drive Controller

The I/O controller is software compatible with the 82077 diskette drive controller and supports both PC-AT and PS/2 modes. In the Setup program, the diskette drive interface can be configured for the following diskette drive capacities and sizes.

- 360 KB, 5.25-inch
- 1.2 MB, 5.25-inch
- 720 KB, 3.5-inch
- 1.2 MB, 3.5-inch (driver required)
- 1.25-1.44 MB, 3.5-inch
- 2.88 MB, 3.5-inch

1-8.4 Keyboard and Mouse Interface

The +5 V lines to keyboard and mouse connectors are protected with a fuse that prevents motherboard components from being damaged when an over-current condition occurs.

The keyboard controller contains code, which provides the traditional keyboard and mouse control functions, and also supports Power On/Reset password protection. Power On/Reset password can be specified in the BIOS Setup program.

The keyboard controller also supports the hot-key sequence <Ctrl><Alt>, software reset. This key sequence resets the computer's software by jumping to the beginning of the BIOS code and running the Power On Self Test (POST).

1-8.5 Infrared Support

The IR connection can be used to transfer files to or from portable devices like laptops, PDAs, and printers.

1-9 AUDIO SUBSYSTEM

1-9.1 Audio Connector

The audio connectors include the following:

- Back panel connectors: stereo line-level output (Line Out), stereo line-level input (Line In), and Mic In
- CD Line - in

1-10 HARDWARE MONITOR

The optional hardware monitor subsystem provides low-cost instrumentation capabilities. The features of the hardware monitor subsystem include:

- An integrated ambient temperature sensor
- Fan speed sensors, which monitor the fan 1 and fan 2 connectors
- Power supply voltage monitoring to detect levels above or below acceptable values

When suggested ratings for temperature, fan speed, or voltage are exceeded, an interrupt is activated. The hardware monitor component connects to the SMBus.

1-11 WAKE ON LAN TECHNOLOGY

Wake on LAN technology enables remote wakeup of the computer through a network. Wake on LAN technology requires a PCI add-in network interface card (NIC) with remote wakeup capabilities. The remote wakeup connector on the NIC must be connected to the onboard Wake on LAN technology connector. The NIC monitors network traffic at the MII interface; upon detecting a Magic Packet, the NIC asserts a wakeup signal that powers up the computer. To access this feature uses the Wake on LAN technology connector.

⚠ CAUTION

For Wake on LAN, the 5-V standby line for the power supply must be capable of delivering +5V \pm 5 % at 720 mA. Failure to provide adequate standby current when implementing Wake on LAN can damage the power supply.

Chapter 2

HARDWARE INSTALLATION

Congratulations on your purchase of **SY-7IWB** Motherboard. You are about to install and connect your new Motherboard.



Note: Do not unpack the Motherboard from its protective anti-static packaging until you have made the following preparations.

2-1 PREPARATIONS

Gather and prepare all the following hardware equipment to complete the installation successfully:

1. Socket 370 processor with built-in CPU cooling fan.
-



Note: This Motherboard supports non-boxed type CPUs.

2. DIMM memory module
3. Computer case and chassis with adequate power supply unit
4. Monitor
5. Keyboard
6. Pointing Device (mouse)
7. Speaker(s) (optional)
8. Disk Drives: HDD, CD-ROM, Floppy drive ...
9. External Peripherals: Printer, Plotter, and Modem (optional)
10. Internal Peripherals: Modem and LAN cards (optional)

2-2 UNPACKING THE MOTHERBOARD

When unpacking the Motherboard, check for the following items:

- ◆ The SY-71WB FW82810 AGP/PCI/AMR Motherboard



- ◆ The Quick Start Guide



- ◆ The Installation CD-ROM



- ◆ One IDE Device Flat Cable



- ◆ One Floppy Disk Drive Flat Cable

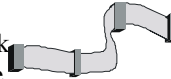

- ◆ One dual 25-pin parallel with 25-pin flat cable and 9-pin serial with 9-pin flat cable external connector

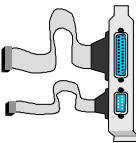

- ◆ One dual 6-pin PS/2 mouse connector with 6-pin flat cable and 9-pin serial connector with 9-pin flat cable

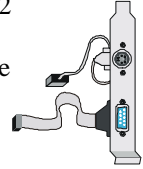

- ◆ VGA port flat cable with a 15-pin connector bracket

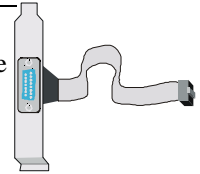

- ◆ One game port and Audio connector bracket with flat cables

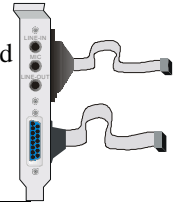

Warning: Do not unpack the Motherboard from its anti-static packaging until you are ready to install it.

Like most electronic equipment, your Motherboard may be damaged by electrostatic discharge. To avoid permanent damage to components ground yourself while working by using a grounding strap. Otherwise, ground yourself frequently by touching the unpainted portion of the computer chassis to drain the static charges.

Handle the Motherboard carefully, holding it by the edges. You are now ready to start the installation.

2-3 INSTALLATION GUIDE

We will now begin the installation of the Motherboard. Please follow the step-by-step procedure designed to lead you to a complete and correct installation.



Warning: Turn off the power to the Motherboard, system chassis, and peripheral devices before performing any work on the Motherboard or system.

BEGIN THE INSTALLATION

2-3.1 CPU Installation

To perform the installation of your new **SY-7IWB** Motherboard, follow the steps below:

Mark your CPU Frequency: Record the working frequency of your CPU that should be clearly marked on the CPU cover.

<input type="checkbox"/> 300MHz (66 x 4.5)	<input type="checkbox"/> 333MHz (66 x 5.0)	<input type="checkbox"/> 366MHz (66 x 5.5)	<input type="checkbox"/> 400MHz (66 x 6.0)
<input type="checkbox"/> 433MHz (66 x 6.5)	<input type="checkbox"/> 466MHz (66 x 7.0)	<input type="checkbox"/> 500MHz (66 x 7.5)	<input type="checkbox"/>

This Motherboard is designed to support processors with 100MHz FSB. However, Socket 370 processors with 100MHz FSB are not available at present.

CPU Mount Procedure: To mount the Celeron™ processor that you have purchased separately, follow these instructions.

1. Lift the socket handle up to a vertical position.

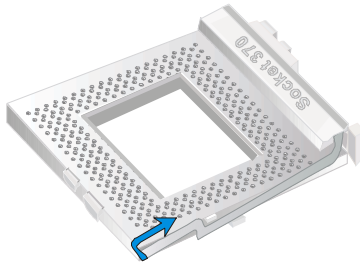

2. Align the blunt edge of the CPU with the matching pinhole distinctive edge on the socket.

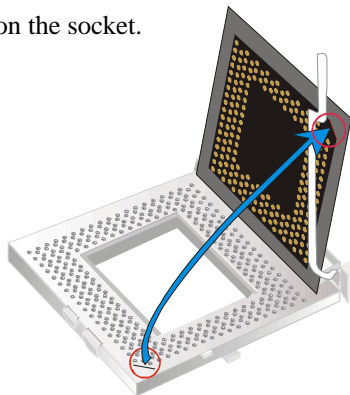

3. Seat the processor in the socket completely and without forcing.

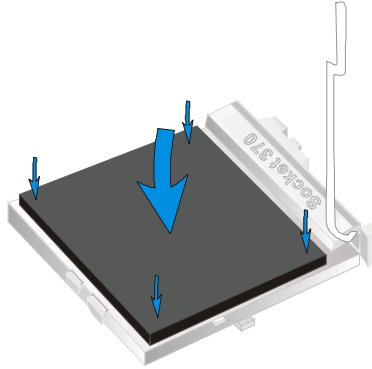

4. Then close the socket handle to secure the CPU in place.

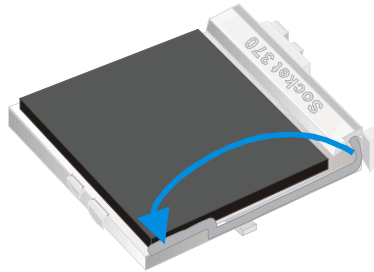

HOT

Remember to connect the CPU Cooling Fan to the appropriate power connector on the Motherboard. *The fan is a key component that will ensure system stability. The fan prevents overheating, therefore prolonging the life of your CPU.*

2-3.2 SDRAM Memory Module Installation

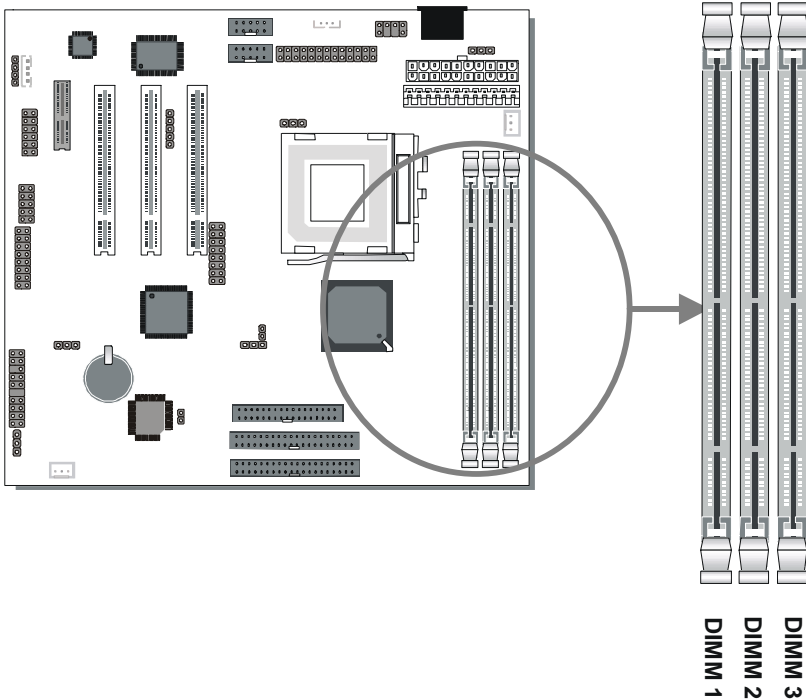

Your board comes with three DIMM sockets, and supports up to 512MB main memory using industry standard Synchronous DRAM (SDRAM), single or double-sided, 3.3V unbuffered DIMM modules from 8MB to 256MB. Registered DIMMs or DIMMs populated with 4 bit wide SDRAM devices are not supported. PC100 compliant DIMM module is required regardless of 66 or 100MHz FSB speed.

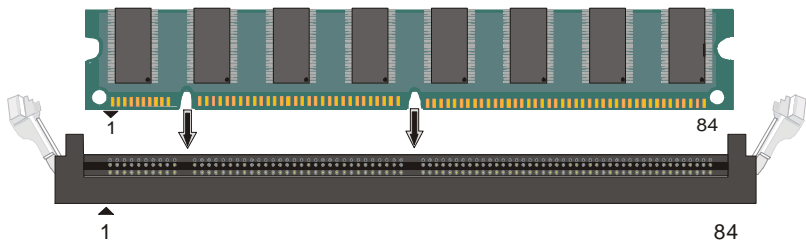



Number of Memory Modules	DIMM 1	DIMM 2	DIMM 3
1	Double-sided/ Single-sided	Double-sided/ Single-sided	
2	Double-sided/ Single-sided	Single-sided	Single-sided ²
RAM Type	SDRAM ¹		
Memory Module Size (MB)	8/16/32/64/256 Mbytes		
<p>Note: 1. PC100 Compliant DIMM module is required regardless of 66 or 100 MHz FSB speed.</p> <p>2. If you want to use DIMM3, DIMM2 must be used as well to let the system work properly. Just plugging a memory module into DIMM3 with DIMM2 left empty, will make the system not working.</p>			

2-3.3 Motherboard Connector

2-3.3.1 IDE Device Installation (HDD, CD-ROM)

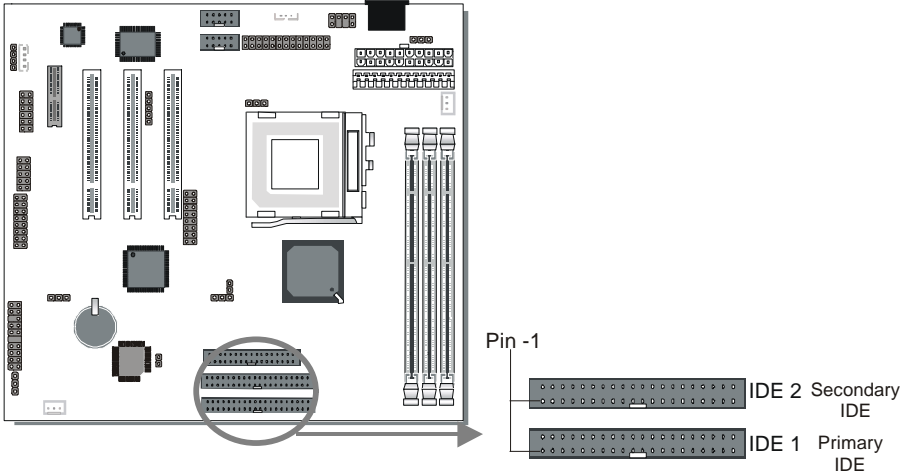

This Motherboard offers two primary and secondary IDE device connectors (IDE1, IDE2). It can support up to four high-speed HDD or CD-ROM.

Connect one side of the 40-pin flat cable to the IDE device (HDD or CD-ROM) and plug the other end to the primary (IDE1) or secondary (IDE2) directionally keyed IDE connector on the Motherboard.

This Motherboard can support up to four HDDs.

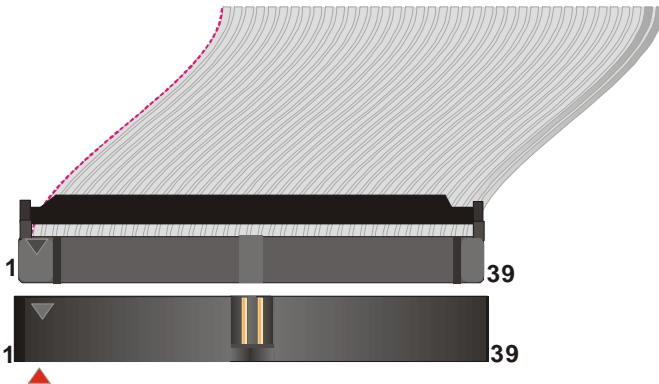

2-3.3.2 Floppy Drive Installation

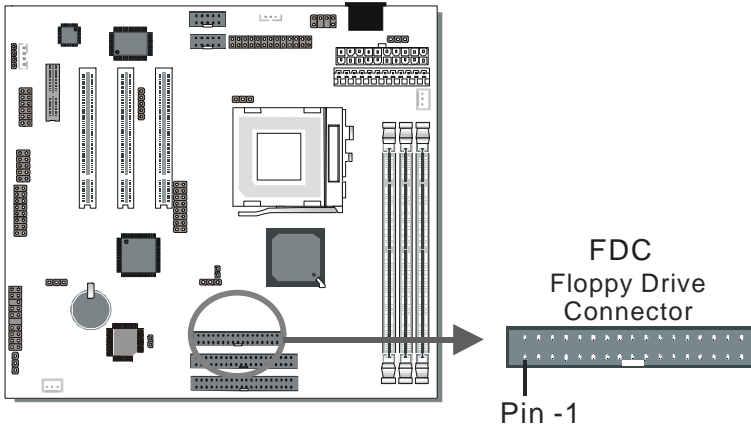

The system supports 5 possible floppy drive types: 720 KB, 1.2 MB, 1.44 MB, 2.88 MB, and LS-120. In addition, this Motherboard supports a 3-mode (720KB/1.2MB/1.44MB) floppy commonly used in Japan. Connect one side of the 34-pin flat cable to the floppy drive and plug the other end to the floppy drive connector on the Motherboard. This Motherboard can support up to 2 floppy drives.

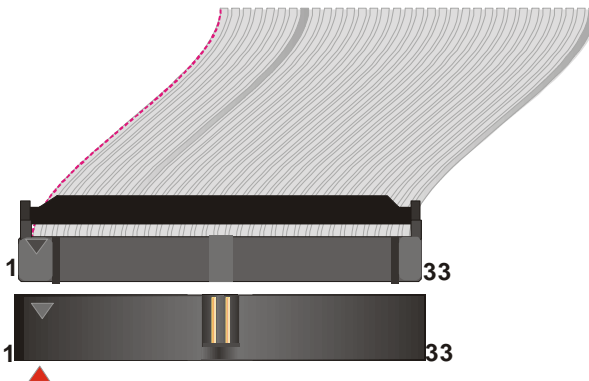

2-3.3.3 Front Panel Connections

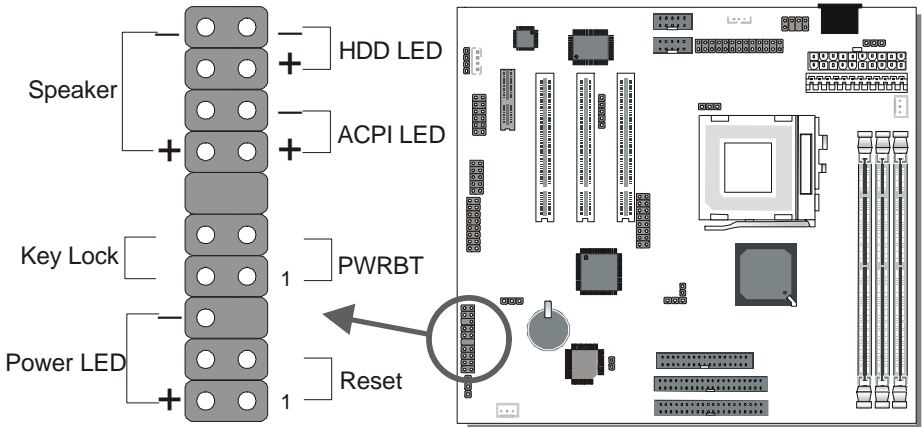

Plug the computer case's front panel devices to the corresponding headers on the Motherboard.

1. Power LED & KeyLock

Plug the Power LED cable into the 5-pin Keylock header.

Some systems may feature a KeyLock function with a front panel switch for enabling or disabling the keyboard. Connect the KeyLock switch to the 5-pin Keylock header on the Motherboard.

Please install according to the following pin assignment: pin 1,3 are for Power LED and pin 4,5 are for Keylock.

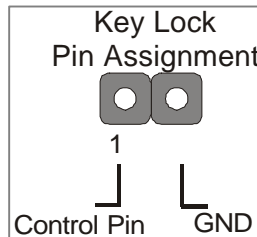
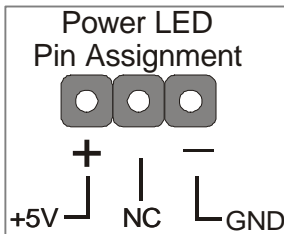

2. Reset

Plug the Reset push-button cable into the 2-pin Reset header on the Motherboard. Pushing the Reset button on the front panel will cause the system to restart the boot-up sequence.

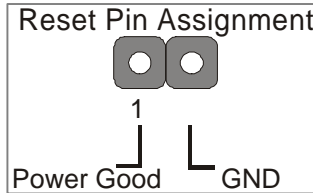

3. Speaker

Attach the 4-pin PC speaker cable from the case to the Speaker header on the Motherboard.

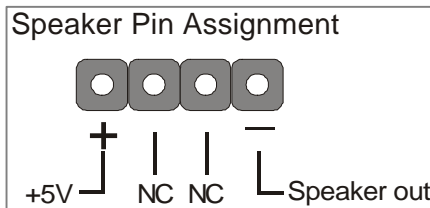

4. ACPI LED

Connecting the 2-pin ACPI LED cable to the corresponding ACPI LED header will cause the LED to light whenever the system is in ACPI mode. The manufacturer has permanently set this Motherboard in ACPI mode due to most hardware and software compliance to ACPI mode.

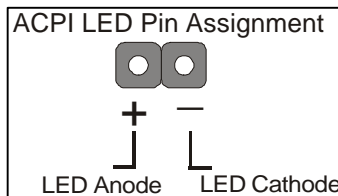

5. IDE LED

Attach the 2-pin IDE device LED cable to the corresponding IDE LED header on the Motherboard. This will cause the LED to lighten when an IDE (HDD, CD-ROM) device is active.

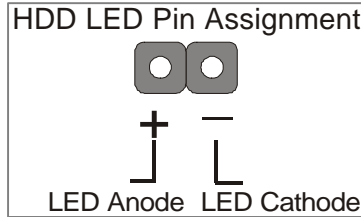

6. ATX Power On/Off Switch

Attach the 2-pin momentary type switch to the PWRBT header for turning On or Off your ATX power supply.

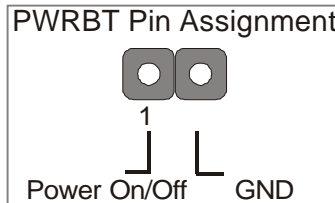

2-3.3.4 Back Panel Connections

2-3.3.5 External Peripherals Connections

External devices such as the keyboard, printer, PS/2 mouse, modem, USB can be connected to the Motherboard. Normally, you can not plug your devices directly onto the Motherboard, except for the keyboard that plugs directly into the back panel KB connector.

For other parallel (PRT1) and serial devices (COM1, COM2), first install the bracket panels that come with your Motherboard on the computer case, then plug the other end of the flat cable to their respective connectors. Only after you have fixed and locked the Motherboard and bracket panels to the computer case you can start connecting the external peripheral devices.

When connecting an external device, use the following figure to locate and identify which back panel connector to plug the device or flat cable to.

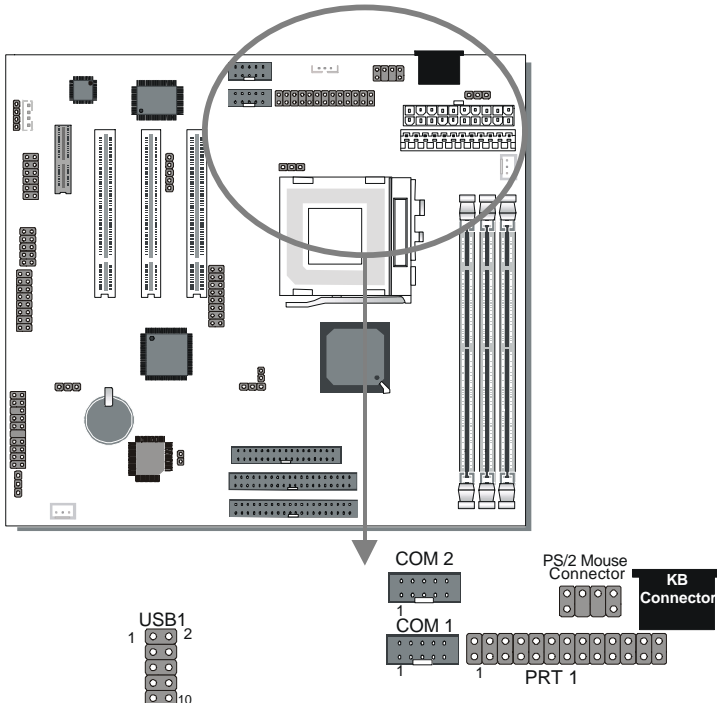

1. Serial Ports COM1/COM2

External Devices that use the COM ports include serial mice and modems. The COM port connectors are located on 2 separate brackets panels, as shown on the figure below. Please plug their respective 10 pin flat cable connectors into the COM1 and COM 2 serial port connectors on the Motherboard.

The bracket panels should be fixed to one of the slots at the back of the computer case using a screw, after having finished this you can plug any serial device into the back panel connectors.

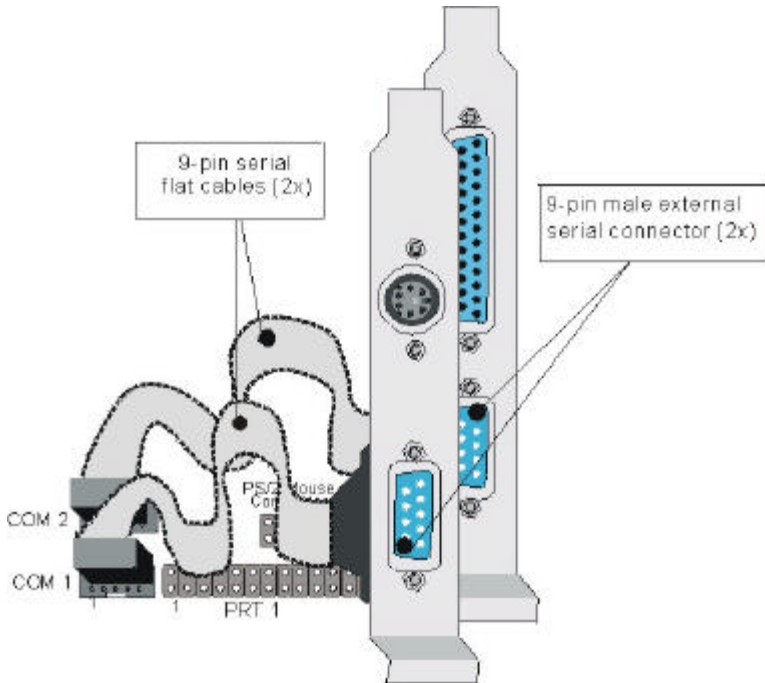

2. Parallel Port PRT1

This parallel port is used to connect the printer or other parallel devices. Your Motherboard comes with one 25-pin female external parallel connector with 25-pin flat cable.

Plug the 25-pin end of the flat cable into the PRT1 parallel connector on the Motherboard, as shown in the figure below, then fix the bracket to one of the slots at the back of the computer case using a screw. After having finished this you can plug any parallel device into the back panel connectors.

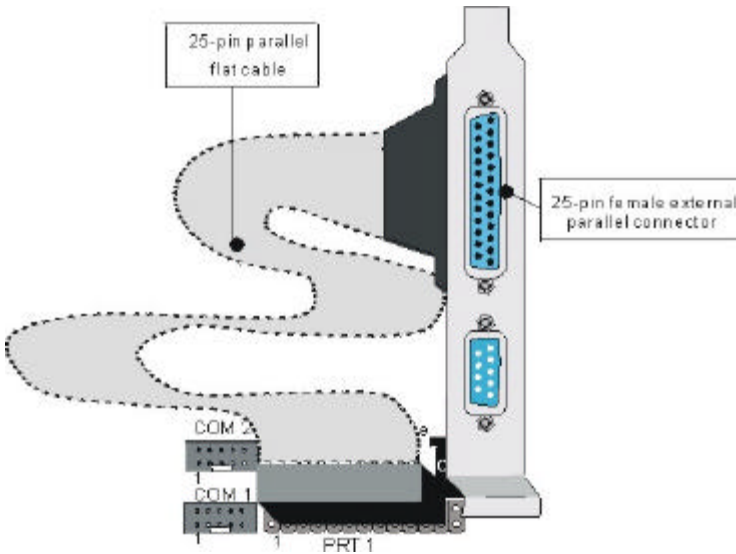

3. AT Keyboard

Plug the keyboard jack directly into the 5-pin female AT keyboard connector located at the rear panel of the Motherboard.



4. PS/2 Mouse

Attach the mouse cable to the 6-pin male PS/2 mouse connector on the Motherboard to make use of a PS/2 mouse.

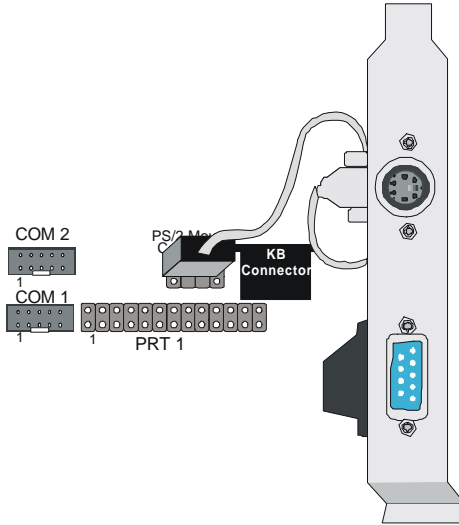

5. Universal Serial Bus (USB)

This Motherboard provides a dual-row 10-pin header (one pin is empty) to support two USB ports for your additional devices. Attach the USB cable (**Optional**) to this header as shown in the diagram below. The USB cable has two USB ports mounted on a bracket.

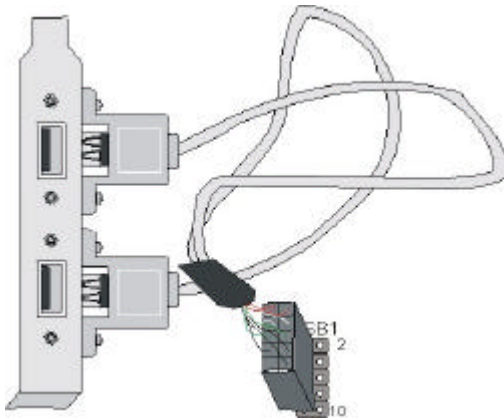

2-3.3.6 Other Connections

1. Wake-On-LAN (WOL)

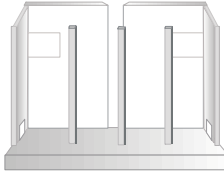

Attach the 3-pin connector from the LAN card which supports the Wake-On-LAN (WOL) function to the JP44 header on the Motherboard. This WOL function lets users wake up the connected computer through the LAN card.

Please install according to the following pin assignment:

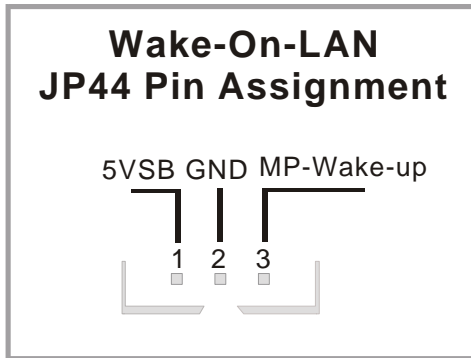

2. Infrared (IR1)

Plug the 5-pin infrared device cable to the IR1 header. This will enable the infrared transfer function. This Motherboard meets both the ASKIR and HPSIR specifications.

Please install according to the following pin assignment:

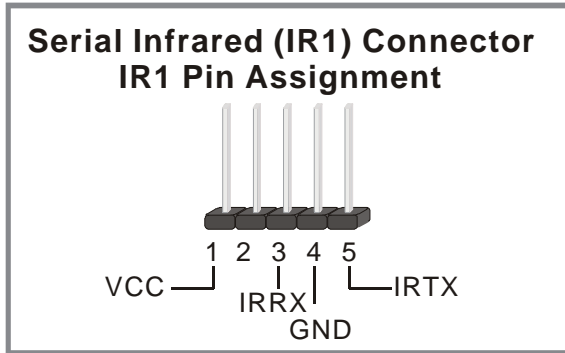

3. CD Line-in (J10,J11)

This Motherboard provides two CD-Line in connectors. Please connect the 4-pin audio cable from your CD-ROM drive to either J10 or J11. (It fits in only one, depending on the cable that came with your CD-ROM drive)

Please install according to the following pin assignment:

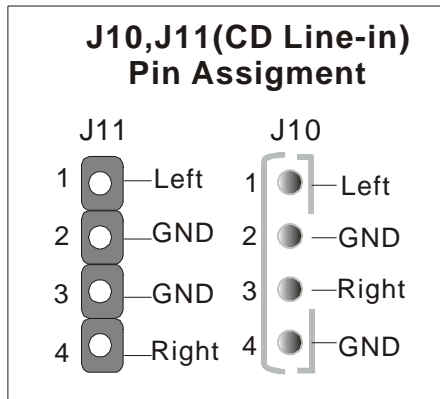

4. Cooling Fan Installation

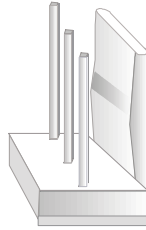

(1) CPU Cooling Fan

After you have seated the CPU properly on the processor, attach the 3-pin fan cable to the CPUFAN connector on the Motherboard. The fan will stop when the system enters into Suspend Mode. (Suspend mode can be enabled from the BIOS Setup Utility, [Soyo Combo] menu.)

To avoid damage to the system, install according to the following pin assignment:

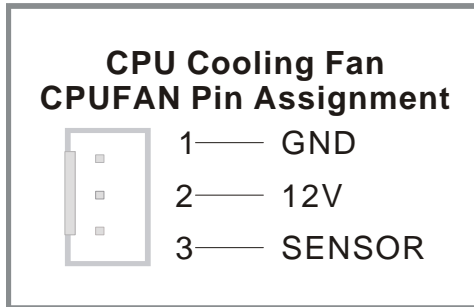

(2) Chassis Cooling Fan

Some chassis also feature a cooling fan. This Motherboard features a CHAFAN connector to provide 12V power to the chassis fan. Connect the cable from the chassis fan to the CHAFAN 3-pin connector. Install according to the following pin assignment:

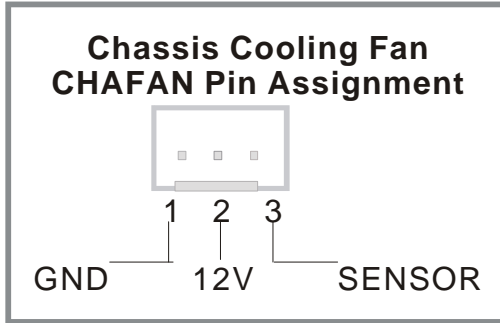

Note: CPU cooling fan must be installed to prevent CPU from overheating and ensure system stability. Chassis cooling fan is optional, depending on whether there is cooling fan in your chassis.

2-3.3.7 AGP VGA Card

This motherboard comes with integrated AGP subsystem therefore, AGP VGA card is not needed.

Other Display Cards: Insert other types of VGA cards into the PCI expansion slots according to card specifications.

2-3.3.8 ATX Power Supply

Plug the connector from the power directly into the 20-pin male ATX PW connector on the Motherboard, as shown in the following figure.

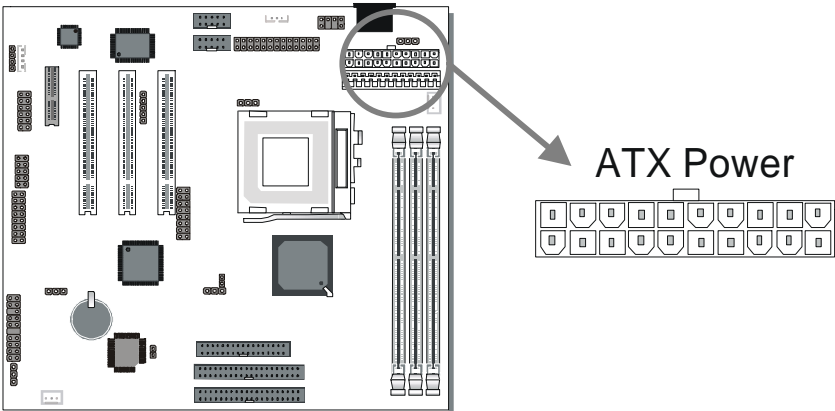

Warning: Follow these precautions to preserve your Motherboard from any remnant currents when connecting to power supply:



Turn off the power supply and unplug the power cord of the power supply before connecting to PW connector.

This motherboard requires a power supply, that meets the ATX 2.03 specifications. Make sure the power supply can support at least 720mA on the 5V Standby lead.

Please install the ATX power according to the following pin assignment:

ATX Power

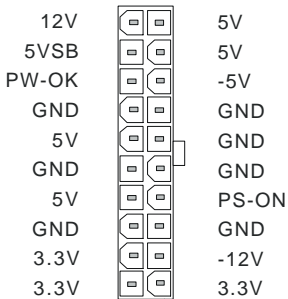

➤ **Pay special care to the directionality.**

2-3.3.9 AT Power Supply

If you are using AT power, plug the dual 6-pin headers from the power directly into the 12-pin male AT Power connector on the motherboard. Make sure black leads of the 6-pin AT power headers are in the center.

Note: DO NOT use an AT powersupply if you already use an ATX powersupply. Use only one type of powersupply at the same time.

2-3.3.10 AMR (Audio Modem Riser) Connector

This motherboard supports AMR (Audio-Modem Riser) slot that facilitates audio or modem riser card expansion. Since AC97 audio codec is built-in down on the motherboard, only “Secondary” mode modem riser (MR) card can be used on the AMR slot.

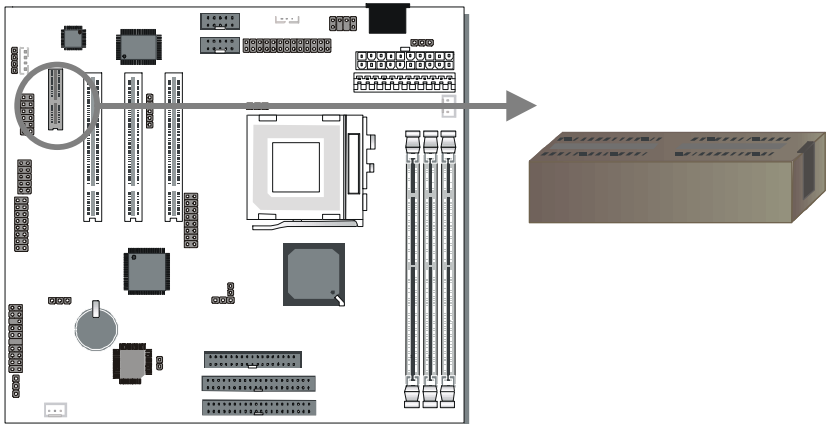





2-3.4 Jumper Setting

Step 1. Set J6 & JP2 to configure CPU FSB Frequency

If the user wants to use the CPU at its standard FSB (Front Side Bus) Frequency, J6 has to be closed. This will make sure the system will provide the CPU with the FSB Frequency it was specified to run at. Make sure that JP2 is open when using this setting.

If the user wants to run the CPU at another (higher) FSB frequency however, J6 has to be open. In this case use JP2 to set the FSB frequency.

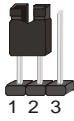
Auto Mode		Description
J6	JP2	Run the CPU at its specified FSB frequency. For 66MHz FSB CPUs 66/75/83 MHz can be selected in the BIOS. For 100MHz FSB CPUs 100~133MHz can be selected in the BIOS.
Short J6 	Must be open 	
<i>Note: Don't put a jumper on JP2 when J6 is set to short.</i>		

Manual Mode		Description
J6	JP2	Set power up FSB frequency to 66MHz if the user wants to run the CPU at a FSB frequency of 66MHz. Only 66~83MHz FSB can be set in the BIOS.
Open J6 	Short pin 1-2 	
J6	JP2	Set Power up FSB frequency to 100MHz if the user wants to run the CPU at an FSB frequency of 100MHz or higher. This setting will allow the user to run the CPU at a higher FSB frequency, especially when the user wants to urn a 66MHz FSB CPU at 100MHz and higher FSB frequencies.
Open J6 	Short pin 2-3 	
<i>Note: The "Manual" mode setting facilitates FSB over-clocking. Doing so will however force your CPU to operate out of its specifications, and therefore SOYO can not guarantee the proper function of your system.</i>		



Step 2. Set the CPU Frequency

This Motherboard does not use any jumpers to set the CPU operating frequency; the CPU settings can be changed through the BIOS [SOYO COMBO SETUP]. Please refer to Chapter 3 “Quick BIOS Setup” for details on setting the Celeron™ processor frequency.

Step 3. Set JP9 for FWH Boot Block Write-Protect



Setting this jumper to open will prevent the boot block area of the FWH (FirmWare Hub) chip from being written data into such that it is write-protected from unwanted or abnormal write activity.

Note: In some rare cases, the boot block area will need to be flashed to complete the BIOS upgrade procedure. Setting JP9 to open will cause incomplete BIOS update in that case.

The FWH Boot Block Write-Protect	Locked	Unlocked
JP9 Setting	open JP9  1 2	short JP9  1 2

Step 4. Enable/Disable Power-On by Keyboard (JP1)

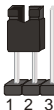

You may choose to enable the Power-On through Keyboard function by shorting pin 1-2 on jumper JP1; or short pin 2-3 to disable this function.

Power-On by Keyboard	Enable	Disable
JP1 Setting	Short pin 1-2 to enable the Power-On by Keyboard function.  1 2 3	Short pin 2-3 and the Power-On by Keyboard function is disabled.  1 2 3

Important: When using the Power-On by Keyboard function, please make sure the ATX power supply is able to provide at least 720mA on the 5V Standby lead (5VSB) in order to meet the standard ATX specification.

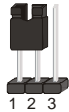

Step 5. PC speaker redirection (JP10)

Through this jumper the case speaker output can be redirected to the external (amplified) speakers (if connected) through the on-board Audio-Codec.

PC speaker redirection	Redirect to external speaker	Use case speaker
JP10 Setting	Short pin 1-2 	Short pin 2-3 

Step 6. CPU Core Voltage Adjust (JP15)

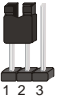
In case your CPU is running on a frequency higher than it is specified for, increasing its core voltage can enhance its stability. Over-clocking your CPU does however force your system to operate outside of its specifications, and therefore SOYO can not guarantee system stability.

CPU Core Voltage Adjust	JP15 Setting	
Default Vcore	short pin 1-2	
5% higher	short pin 2-3	

2-3.5 CMOS Clearing (JP5)

After you have turned off your computer, clear the CMOS memory by momentarily shorting pins 2-3 on jumper JP5, for a few seconds. Then restore JP5 to the initial 1-2 jumper setting in order to recover and retain the default settings.

Jumper JP5 can be easily identified by its white colored cap.

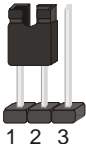
CMOS Clearing	Clear CMOS Data	Retain CMOS Data
JP5 Setting	Short pin 2-3 for <i>at least 5 seconds</i> to clear the CMOS	Short pin 1-2 to retain new settings
		
Note: You must unplug the ATX power cable from the ATX power connector when performing the CMOS Clear operation.		

2-3.6 Power On

You have now completed the hardware installation of your Motherboard successfully.

1. Turn the power on
2. To enter the BIOS Setup Utility, press the key while the system is performing the diagnostic checks,



Note: If you have failed to enter the BIOS, wait until the boot up sequence is completed. Then push the RESET button and press key again at the beginning of boot-up, during diagnostic checks.

Repeat this operation until you get the following screen.

3. The BIOS Setup screen appears:

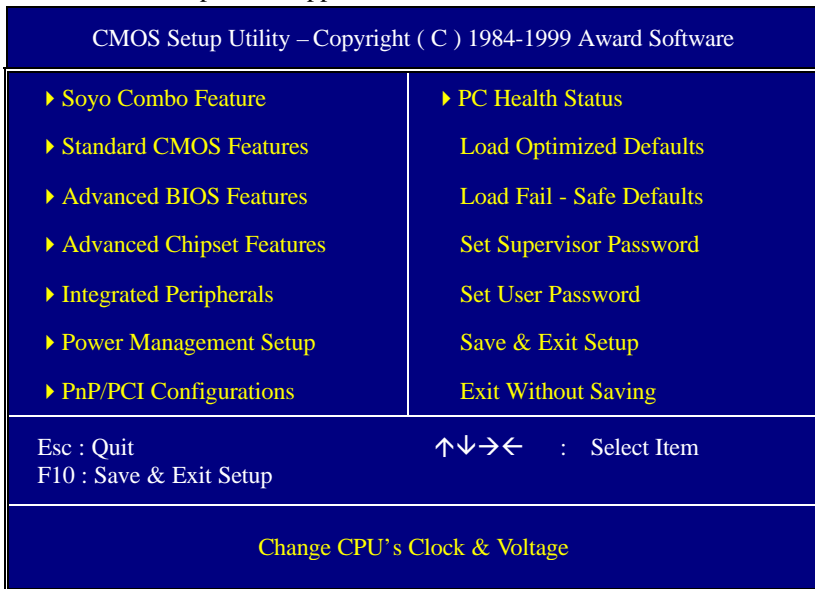

2-3.7 Quick BIOS Setup

This Motherboard does not use any hardware jumpers to set the CPU frequency. Instead, CPU settings are software configurable with the BIOS [Soyo Combo Feature]. The [Soyo Combo Feature] menu combines the main parameters that you need to configure, all in one menu, for a quick setup in BIOS.

After the hardware installation is complete, turn the power switch on, then press the key during the system diagnostic checks to enter the Award BIOS Setup program. The CMOS SETUP UTILITY will display on screen. Follow these steps to configure the CPU settings.

SETUP UTILITY will display on screen. Then, follow these steps to configure the CPU settings.

Step 1. Select [STANDARD CMOS SETUP]

Set [Date/Time] and [Floppy drive type], then set [Hard Disk Type] to “Auto”.

Step 2. Select [Load Optimized Defaults]

Select the “Load Optimized Defaults” menu and type “Y” at the prompt to load the BIOS optimal setup.

Step 3. Select [Soyo Combo Feature]

(a) CPU Host/PCI Clock

CPU Host / PCI Clock			The PCI clock frequency depends on the CPU Host clock. (Fixed pairs in the clock generator) see the table on the left side for all possible pairs.
<input type="checkbox"/> 66/33	<input type="checkbox"/> 100/33	<input type="checkbox"/> 133/44	
<input type="checkbox"/> 70/35	<input type="checkbox"/> 105/35	<input type="checkbox"/> 140/35	
<input type="checkbox"/> 75/37	<input type="checkbox"/> 114/38	<input type="checkbox"/> 150/37	
<input type="checkbox"/> 83/41	<input type="checkbox"/> 120/40		
<input type="checkbox"/> 90/30	<input type="checkbox"/> 124/41		
<input type="checkbox"/> 95/31	<input type="checkbox"/> 133/33		

(b) CPU Ratio

After you have selected the CPU Host/ PCI Clock, choose the right multiplier for the CPU. CPU Ratio options are:

<input type="checkbox"/> x 2	<input type="checkbox"/> x 2.5	<input type="checkbox"/> x 3	<input type="checkbox"/> x 3.5	<input type="checkbox"/> x 4
<input type="checkbox"/> x 4.5	<input type="checkbox"/> x 5	<input type="checkbox"/> x 5.5	<input type="checkbox"/> x 6	<input type="checkbox"/> x 6.5
<input type="checkbox"/> x 7	<input type="checkbox"/> x 7.5	<input type="checkbox"/> x 8		

The CPU frequency is then defined as [host clock freq.] x [multiplier], and should be the working frequency of your CPU's processor.

Step 4. Select [Save & Exit Setup]

Press <Enter> to save the new configuration to the CMOS memory, and continue the boot sequence.

2-3.8 Troubleshooting at First Start

- ***What should I do if the Motherboard refuses to start?***
 1. Check that all DIMM memory modules are inserted completely. Sometimes a DIMM that is not inserted properly can cause boot problems.
 2. Check whether all Add-on cards have been inserted properly. Re-insert the Add-on cards to make sure that they make proper contact with the slots. Try removing all Add-on cards one by one to see whether or not one of them is causing problems. (Switch the system off before removing any of the cards.)
 3. Verify that speed settings are not exceeding specifications. This applies to the PCI bus, that is specified to run at 33 MHz. Also check the speed setting for the memory, make sure conservative setting is used. If the CPU is overclocked the system may not start up, read the section below.
 4. Make sure that the Harddisk IDE cables are attached properly, if not the system will not boot. In case of doubt try reversing the IDE connector on one end of the cable.
 5. Verify that the 110/220V switch on the back of the power supply is set correctly.
 6. Go through the jumper setting section again to make sure that all jumpers are set correctly.



Note on Over-clocking Capability

The SY-7IWB provides over-clocking capability. Due to the over-clocking setting your system may fail to boot up or hang during run time. Please perform the following steps to recover your system from the abnormal situation :

1. Turn off system power (If you use an ATX power supply, and depending on your system, you may have to press the power button
-

for more than 4 seconds to shut down the system.)

2. Press and hold down the <Insert> key while turning on the system power. Keep holding down the <Insert> key until you see the message of the CPU type and frequency shown on the screen.
3. Press the key during the system diagnostic checks to enter the Award BIOS Setup program.
4. Select [Save & Exit SETUP] and press <Enter> to save the new configuration to the CMOS memory, and continue the boot sequence.

Note: SOYO does not guarantee system stability if the user over clocks the system. Any malfunctions due to over-clocking are not covered by the warranty.

2-3.9 Power Off

There are two possible ways to turn off the system:

1. Use the **Shutdown** command in the **Start Menu** of Windows 95/98 to turn off your computer.
2. Press the mechanical power-button and **hold down for over 4 seconds**, to shutdown the computer. If you press the power-button for less than 4 seconds, then your system will enter into **Suspend Mode**.

You are now ready to configure your system with the BIOS setup program. Go to *Chapter 3: BIOS SETUP*

Chapter 3

BIOS SETUP UTILITY

This Motherboard's BIOS setup program uses the ROM PCI/ISA BIOS program from Award Software Inc.

To enter the Award BIOS program's Main Menu:

1. Turn on or reboot the system.
2. After the diagnostic checks, press the [Del] key to enter the Award BIOS Setup Utility.

CMOS Setup Utility – Copyright (C) 1984-1999 Award Software	
<ul style="list-style-type: none"> ▶ Soyo Combo Feature ▶ Standard CMOS Features ▶ Advanced BIOS Features ▶ Advanced Chipset Features ▶ Integrated Peripherals ▶ Power Management Setup ▶ PnP/PCI Configurations 	<ul style="list-style-type: none"> ▶ PC Health Status Load Optimized Defaults Load Fail - Safe Defaults Set Supervisor Password Set User Password Save & Exit Setup Exit Without Saving
Esc : Quit F10 : Save & Exit Setup	↑↓→← : Select Item
Change CPU's Clock & Voltage	

Selecting items

- Use the arrow keys to move between items and select fields.
- From the Main Menu press arrow keys to enter the selected submenu.

Modifying selected items

- Use the [Up]/[Down] keys to modify values within the selected fields. Some fields let you enter values directly.

Hot Keys: Function keys give you access to a group of commands throughout the BIOS utility.

Function	Command	Description
F1	General Help	Gives the list of options available for each item.
F5	Previous Values	Restore the old values. These are the values that the user started the current session with.
F6	Load Fail-Safe Defaults	Loads all items with the most conservative values.
F7	Load Optimized Defaults	Loads all options with the optimize values.
F10	Save	Saves your changes and reboots the system.
[Esc]	Exit	Returns at anytime and from any location to the Main Menu.
[Enter]	Select	Will display a overlapping window with all options for the current item.
[+/-/PU/PD]	Value	Using the +, -, Page Up and Page Down keys the user can toggle the value of the current item.

SAVE AND EXIT SETUP

Select the [SAVE & EXIT SETUP] option from the Main Menu to save data to CMOS and exit the setup utility. This option saves all your changes and causes the system to reboot.

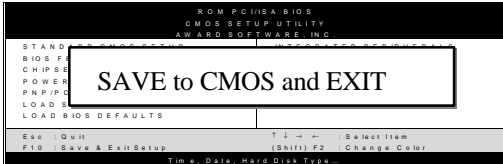

Type [Y] to save the changes and exit or [N] to return to the Main Menu and keep current values.

EXIT WITHOUT SAVING

Selecting the [EXIT WITHOUT SAVING] option allows you to abandon all data and exit setup, therefore ignoring all your changes.

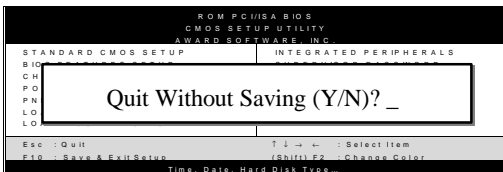

Type [Y] to abandon changes and exit or [N] to return to the Main Menu and keep current values.



3-1 SOYO COMBO SETUP

This Motherboard does not use any hardware jumpers to set the CPU frequency. Instead, CPU settings are software configurable with the BIOS [SOYO COMBO SETUP].

After the hardware installation is complete, turn the power switch on, then press the key during the system diagnostic checks to enter the Award BIOS Setup program. The CMOS SETUP UTILITY will display on screen. Then, select the [SOYO COMBO SETUP] option from the main menu and press the <Enter> key.

CMOS Setup Utility – Copyright (C) 1984-1999 Award Software
Soyo Combo Feature

CPU Host/PCI Clock	Default	▲	Item Help
CPU Ratio	X 3	▼	
CPU L2 Cache ECC Checking	Enabled		Menu Level ▶
Quick Power On Self Test	Enabled		
SMAA [7:4] / SMAB [7:4]	1x / 1x		
First Boot Device	Floppy		
Second Boot Device	HDD-0		
Third Boot Device	LS/ZIP		
Boot Other Device	Enabled		
AC97 Audio	Enabled		
AC97 Modem	Enabled		
POWER ON Function	Button Only		
x KB Power ON Password	Enter		
x Hot Key Power ON	Ctrl-F1		
Soft-Off by PWR-BTTN	Instant-Off		
Wake-Up by PCI card	Disabled		
Resume by Alarm	Disabled		
x Date (of Month) Alarm	0		
x Time (hh:mm:ss) Alarm	0 0 0		

↑↓→←:Move Enter:Select +/-/PU/PD:Value F10:Save ESC:Exit F1:General Help
 F5:Previous Values F6:Fail-Safe Defaults F7: Optimized Defaults

The [SOYO COMBO SETUP] menu combines the main parameters that you need to configure, all in one menu, for a quick setup in BIOS.

3-1.1 Quick CPU Frequency Setup

Quick CPU Frequency Setup	Setting		Description	Note
CPU Host/PCI Clock	Default	105/35 MHz	Select the host clock of your Socket 370 processor among these values. Note: For the 810 chipset, 66 and 100 MHz host clock frequencies are acceptable. However, the system stability is not guaranteed for other frequencies due to the limitations of this chipset.	
	66/33 MHz	114/38 MHz		
	70/35 MHz	120/40 MHz		
	75/37 MHz	124/41 MHz		
	83/41 MHz	133/33 MHz		
	90/30 MHz	133/44 MHz		
	95/31 MHz	140/35 MHz		
	100/33 MHz	150/37 MHz		
CPU Ratio	After you have selected the host clock, choose the right multiplier for the CPU. Options are: [2, 2.5, 3., 3.5, 4, 4.5, 5, 5.5, 6, 6.5, 7, 0, 7.5, 8, 0]. The CPU frequency is then defined as [host clock freq.]x[multiplier], and should be the working frequency of your Pentium®III, Pentium®II & Celeron™ processor.			

3-1.2 L2 Cache Memory

	Setting	Description	Note
CPU L2 Cache ECC Checking	Disabled		
	Enabled	This option activates the CPU L2 cache ECC checking function.	Default
Quick Power On Self Test	Disabled		
	Enabled	Provides a fast POTS at boot-up.	Default



3-1.3 Memory Buffer Strength

	Setting		Description	Note
SMAA [7:4] / SMAB [7:4]	1x / 1x		This item sets the strength of the buffer that drives the address section of the memory bus. Change the setting only if you are an experienced user.	Default
	4x / 4x	2x / 4x		
	4x / 3x	2x / 3x		
	4x / 2x	2x / 2x		
	4x / 1x	2x / 1x		
	3x / 4x	1x / 4x		
	3x / 3x	1x / 3x		
	3x / 2x	1x / 2x		
	3x / 1x	1x / 1x		

3-1.4 System Boot Control Settings

System Boot Control Settings	Setting		Description	Note
First /Second/Third Boot Device	Floppy		Select Your Boot Device Priority	
	LS/ZIP			
	HDD-0			
	SCSI			
	CDROM			
	HDD-1			
	HDD-2			
	HDD-3			
	LAN			
	Disabled			
Boot Other Device	Disabled		Select Your Boot Device Priority	
	Enabled			Default
AC97 Audio/Modem	Disabled		This item allows you to decide to enable/disable the 810 chipset family to support AC97 Audio/Modem.	Default
	Enabled			

3-1.5 Others Optional

	Setting	Description	Note
POWER ON Function	Password	Enables you to wake-up the system by entering a password at the keyboard.	
	HotKEY	You can wake-up the system by pressing the key combination of your choice (Ctrl-F1~F12).	
	Mouse Left	Enables waking up the system by pressing either the right or left mouse button.	
	Mouse Right		
	BUTTON-ONLY	Disables the Wake-Up by Keyboard function.	Default
	Keyboard 98		
If [POWER ON Function] is set to [Password]			
KB Power ON Password	Enter (your password)	Set the password that will wake-up your system.	
If [POWER ON Function] is set to [Hot Key]			
Hot Key Power ON	Ctrl-F1~F12	Choose the key combination that will wake-up the system. [Ctrl-F1 to Ctrl-F12]	
Soft-Off by PWR-BTTN	Instant-off		Default
	Delay 4 Sec.	Turns off the system power 4 seconds after pushing the power button.	
Wake-Up by PCI card	Disabled	If enabled any PCI interrupt will wake up the system.	Default
	Enabled		
Resume by Alarm	Disabled	The system ignores the alarm.	Default
	Enabled	Set alarm to power on the system by the date (1-31) or time (hh:mm:ss). If the date is set to [0], the system will self-power on by alarm everyday at the set time.	

3-2 STANDARD CMOS SETUP

Select the [STANDARD CMOS SETUP] option from the Main Menu and press [Enter] key.

CMOS Setup Utility – Copyright (C) 1984-1999 Award Software
 Standard CMOS Features

Date (mm:dd:yy)	Fri, Jan 1 1999	Item Help
Time (hh:mm:ss)	1 : 22 : 12	
▶ IDE Primary Master	Press Enter None	Menu Level ▶
▶ IDE Primary Slave	Press Enter None	
▶ IDE Secondary Master	Press Enter None	
▶ IDE Secondary Slave	Press Enter None	
Drive A	1.44M, 3.5 in.	
Drive B	None	
Floppy 3 Mode Support	Disabled	
Video	EGA/VGA	
Halt On	All Errors	
Base Memory	640K	
Extended Memory	30720K	
Total Memory	31744K	

↑↓→←:Move Enter:Select +/-/PU/PD:Value F10:Save ESC:Exit F1:General Help
 F5:Previous Values F6:Fail-Safe Defaults F7: Optimized Defaults

This screen allows you to modify the basic CMOS settings.

After you have completed the changes, press [Esc] key to return to the Main Menu.

3-2.1 Date & Time

	Display	Setting	Please Note
Date	mm/dd/yyyy	Type the current date	You can also the PUp/PDn keys to toggle
Time	hh:mm:ss	Type the current time	24-hour clock format 3:15 PM is displayed as 15:15:00

3-2.2 Hard Disks Type & Mode

Choose the type and mode for the hard disks that you have already installed.

Primary (Secondary) Master & Slave	Setting	Description	Note
IDE HDD Auto-Detection	Press Enter	To auto-detect the HDD's size, head ..on this channel	
	Auto	BIOS detects hard disk type automatically.	Default
IDE Primary Slave (User Type)	User	User defines the type of hard disk.	
	None		
Access Mode	Auto	BIOS detects hard disk mode automatically.	Default
	Normal	Normal IDE hard disk	<528MB
	LBA	Enhanced IDE hard disk	>528MB
	Large	Large IDE hard disk (for certain hard disk)	



Note: If you have any questions on your hard disk type or mode, ask your hard disk provider or previous user for details.

3-2.3 Floppy Drives

Floppy Drives	Setting	Description	Note
Drives A & B	360KB, 5.25 in.		
	1.2MB, 5.25 in.		
	720KB, 3.5 in.		
	1.44MB, 3.5 in.		Default
	2.88MB, 3.5 in.		
	None	Not installed	
Floppy 3-Mode Support	Disabled		Default
	Drive A Drive B Both	Supports 3-mode floppy diskette: 740KB/1.2MB/1.44MB on selected disk drive.	Special disk drive commonly used in Japan

3-2.4 Others Optional

	Setting	Description	Note
Video	EGA/VGA	Select the video mode.	Default
	CGA 40		
	CGA 80		
	MONO (Monochrome)		
Halt On	ALL Errors	When the BIOS detects system errors, this function will stop the system. Select which type of error will cause the system halt.	Default
	No Errors		
	All, But Keyboard		
	All, But Diskette		
	All, But Disk/Key		

3-3 ADVANCED BIOS FEATURES

Select the [Advanced BIOS Features] option from the Main Menu and press [Enter] key.

CMOS Setup Utility – Copyright (C) 1984-1999 Award Software Advanced BIOS Features		Item Help
Anti-Virus Protection	Enabled	Menu Level ▶
CPU Internal Cache	Enabled	
External Cache	Enabled	
Swap Floppy Drive	Disabled	
Boot Up Floppy Seek	Disabled	
Boot Up NumLock Status	On	
Gate A20 Option	Fast	
Typematic Rate Setting	Disabled	
x Typematic Rate (Chars/Sec)	6	
x Typematic Delay (Msec)	250	
Security Option	Setup	
OS Select For DRAM > 64MB	Non-OS2	
Report No FDD For WIN 95	Yes	

↑↓→←:Move Enter:Select +/-/PU/PD:Value F10:Save ESC:Exit F1:General Help
 F5:Previous Values F6:Fail-Safe Defaults F7: Optimized Defaults

After you have completed the changes, press [Esc] key and follow the instructions on your screen to save your settings or exit without saving.

3-3.1 Virus Warning

	Setting	Description	Note
Anti - Virus Protection	Disabled	If set to enabled, the Paragon Anti-Virus. Function will scan your boot drive for boot viruses. If a boot virus is detected, the BIOS will display a warning message.	Default
	Enabled		

3-3.2 Cache Memory Options

	Setting	Description	Note
CPU Internal Cache	Disabled	Enables the CPU's internal cache.	Default
	Enabled		
External Cache	Disabled	Enables the external memory.	Default
	Enabled		

3-3.3 Floppy Driver Settings

	Setting	Description	Note
Swap Floppy Drive	Disabled	Changes the sequence of A and B drives.	Default
	Enabled		

3-3.4 Boot Up Floppy Seek

	Setting	Description	Note
Boot Up Floppy Seek	Disabled	Seeks disk drives during boot up. Disabling speeds boot up.	Default
	Enabled		

3-3.5 Boot Up NumLock Status

	Setting	Description	Note
Boot Up NumLock Status	On	Puts numeric keypad in NumLock mode at boot-up.	Default
	Off	Puts numeric keypad in arrow key mode at boot-up.	

3-3.6 Gate A20 Options

	Setting	Description	Note
Gate A20 Options	Normal	Lets chipset control GateA20.	
	Fast	A pin in the keyboard controller controls GateA20.	Default

3-3.7 Typematic Settings

Typematic Settings	Setting	Description	Note
Typematic Rate Setting	Disabled	Keystrokes repeat at a rate determined by the keyboard.	Default
	Enabled	When enables , the typematic rate and typematic delay can be selected.	
The following [Typematic Rate] and [Typematic Delay] fields are active only if [Typematic Rate Setting] is set to [Enabled]			
Typematic Rate	6 (Char/sec)	Choose the rate at which a character is repeated when holding down a key.	Default
	8 (Char/sec)		
	10 (Char/sec)		
	12 (Char/sec)		
	15 (Char/sec)		
	20 (Char/sec)		
	30 (Char/sec)		
Typematic Delay	250 (msec)	Choose how long after you press a key down the character begins repeating.	Default
	500 (msec)		
	750 (msec)		
	1000 (msec)		

3-3.8 Security Option

Use this feature to prevent unauthorized system boot-up or use of BIOS Setup. The following table describes the security settings.

Security Option	Setting	Description
	System	Each time the system is booted, the password prompt appears.
	Setup	If a password is set, the password prompt only appears when you attempt to enter the BIOS Setup program.

Other Control Options

Other Control Options	Setting	Description	Note
OS Select for DRAM>64MB	OS2	When using an OS2 operating system.	
	Non-OS2	When using another, non-OS2 operating system.	Default
Report No FDD For WIN 95	Yes	Windows will release IRQ line 6 (normally used by the Floppy Disk Drive) after you disable your on-board FDD and set this field to [Yes].	Default
	No	Windows will reserve INT 6 for your FDD, whether it is disabled or not.	

3-4 ADVANCED CHIPSET FEATURES



Caution: Change these settings only if you are already familiar with the Chipset.

The [Advanced Chipset Features] option changes the values of the chipset registers. These registers control the system options in the computer.

CMOS Setup Utility – Copyright (C) 1984-1999 Award Software
 Advanced Chipset Features

SDRAM CAS Latency Time 3 SDRAM Cycle Time Tras/Trc 6/8 SDRAM RAS-to-CAS Delay 3 SDRAM RAS Precharge Time 3 System BIOS Cacheable Disabled Video BIOS Cacheable Disabled Memory Hole AT 15M- 16M Disabled Delayed Transaction Enabled Spread Spectrum Disabled	Item Help <hr/> Menu Level ▶
--	---------------------------------

↑↓→←:Move Enter:Select +/-/PU/PD:Value F10:Save ESC:Exit F1:General Help
 F5:Previous Values F6:Fail-Safe Defaults F7: Optimized Defaults

After you have completed the changes, press [Esc] and follow the instructions on your screen to save your settings or exit without saving. The following table describes each field in the Advanced Chipset Features Menu and how to configure each parameter.

CHIPSET FEATURES SETUP

CHIPSET FEATURES	Setting	Description	Note
SDRAM CAS Latency Time	2	Use the default setting	Default
	3		
SDRAM Cycle Time Tras/Trc	5/7	Use the default setting	Default
	6/8		
SDRAM RAS-to-CAS Delay	3	Use the default setting	Default
	2		
System BIOS Cacheable	Disabled	The ROM area F0000H-FFFFFH is cacheable.	Default
	Enabled		
Video BIOS Cacheable	Disabled	The video BIOS C0000H-C7FFFH is cacheable.	Default
	Enabled		
Memory Hole At 15M-16M	Disabled	Some interface cards will map their ROM address to this area. If this occurs, select [Enabled] in this field.	Default
	Enabled		
Delayed Transaction	Enabled	Use the default setting	Default
	Disabled		
Spread Spectrum	Disabled	When using Spread Spectrum Modulated 1.5% or 6% for FCC or DOC testing.	Default
	Enabled		

3-5 INTEGRATED PERIPHERALS



Caution: Change these settings only if you are already familiar with the Chipset.

The [INTEGRATED PERIPHERALS] option changes the values of the chipset registers. These registers control the system options in the computer.

The following screen shows setup default settings.

CMOS Setup Utility – Copyright (C) 1984-1999 Award Software Integrated Peripherals				
On-Chip Primary PCI IDE	Enabled	<table border="1"> <tr> <th>Item Help</th> </tr> <tr> <td>Menu Level ▶</td> </tr> </table>	Item Help	Menu Level ▶
Item Help				
Menu Level ▶				
On-Chip Secondary PCI IDE	Enabled			
IDE Primary Master PIO	Auto			
IDE Primary Slave PIO	Auto			
IDE Secondary Master PIO	Auto			
IDE Secondary Slave PIO	Auto			
IDE Primary Master UDMA	Auto			
IDE Primary Slave UDMA	Auto			
IDE Secondary Master UDMA	Auto			
IDE Secondary Slave UDMA	Auto			
USB Controller	Enabled			
USB Keyboard Support	Disabled			
Init Display First	PCI Slot			
IDE HDD Block Mode	Enabled			
Onboard FDC Controller	Enabled			
Onboard Serial Port 1	3F8/IRQ4			
Onboard Serial Port 2	2F8/IRQ3			
UART Mode Select	Normal			
x RxD , TxD Active	Hi, Lo			
x IR Transmittion delay	Enabled			
x UR2 Duplex Mode	Half			
x Use IR Pins	IR-R x 2T x 2			
Onboard Parallel Port	378/IRQ7			
Parallel Port Mode	SPP			
x EPP Mode Select	EPP1.7			
x ECP Mode Use DMA	3			
PWRON After PWR-Fail	Off			
Game Port Address	201			
Midi Port Address	Disabled			
x Midi Port IRQ	5			

↑↓→←:Move Enter:Select +/-/PU/PD:Value F10:Save ESC:Exit F1:General Help
 F5:Previous Values F6:Fail-Safe Defaults F7: Optimized Defaults

The following tables describe each field in the INTEGRATED PERIPHERALS Menu and provide instructions on how to configure the IDE controls, FDC controls, and the onboard serial and parallel ports.

3-5.1 IDE Device Controls

IDE Controls	Setting	Description	Note
On-Chip PCI IDE	Disabled	Turn off the on-board IDE	
	<ul style="list-style-type: none"> ➤ Primary ➤ Secondary 	Enabled	Use the on-board IDE
IDE	mode 0-4	0 is the slowest speed 4 is the fastest speed	
	<ul style="list-style-type: none"> ➤ Primary Master PIO ➤ Primary Slave PIO ➤ Secondary Master PIO ➤ Secondary Slave PIO 	Auto	For better performance and stability, we suggest you use the Auto setting to set the HDD control timing.
IDE	Disabled		
	<ul style="list-style-type: none"> ➤ Primary Master UDMA ➤ Primary Slave UDMA ➤ Secondary Master UDMA ➤ Secondary Slave UDMA 	Auto	Select Auto to enable Ultra DMA Mode support.

3-5.2 Keyboard Controls

Keyboard Controls	Setting	Description	Note
USB Controller	Disabled		
	Enabled	Select <i>Enabled</i> if your system contains a Universal Serial Bus (USB) controller and you have USB peripherals.	Default
USB Keyboard Support	Disabled	Turn off the on-board IDE	Default
	Enabled	Use a USB keyboard	
Init Display First	PCI Slot	Choose which card – AGP	Default
	AGP	Display card or PCI VGA card – to initialize first.	

3-5.3 IDE HDD Block Mode

	Setting	Description	Note
IDE HDD Block Mode	Disabled		
	Enabled	Invokes multi-sector transfer instead of one sector per transfer. Not all HDDs support this function.	Default

3-5.4 FDC Controls

FDC Controls	Setting	Description	Note
Onboard FDC controller	Disabled	Turn off the on-board floppy controller	
	Enabled	Use the on-board floppy controller	Default

3-5.5 Onboard Serial Ports

Onboard Serial Ports	Setting	Description	Note
Onboard Serial Port 1 / Serial Port 2	Disabled		
	3F8/IRQ4	Choose serial port 1 & 2's I/O address.	Default (port 1)
	2F8/IRQ3	Do not set port 1 & 2 to the same address except for Disabled or Auto.	Default (port 2)
	3E8/IRQ4		
	2E8/IRQ3		
	Auto		
UART Mode Select	Normal	The second serial port offers these InfraRed interface modes.	Default
	IrDA		
	ASKIR		
If [UART Mode Select] is set to [IrDA]/[ASKIR]			
RxD, TxD Active	Hi, Hi, Lo, Lo, Lo, Hi, Hi, Lo	This item allows you to determine the active of RxD, TxD.	
IR Transmittiion delay	Disabled		
	Enabled	Some IR devices need this item enabled.	Default

Onboard Serial Ports (Continued)

Onboard Serial Ports	Setting	Description	Note
UR2 Duplex Mode	Half	Choose [Half] or [Duplex] to set UR2 in half duplex mode or full duplex mode respectively. Refer to your IR device specifications to select the suitable mode.	Default
	Duplex		
Use IR Pins	IR-Rx2Tx2	Depending on the capabilities of the receiving device, set this item to full or half duplex. (Full duplex allows sending and receiving simultaneously, half duplex only allows sending and receiving to occur separately).	Default
	RxD2,TxD2		

3-5.6 Onboard Parallel Ports

Onboard Parallel Ports	Setting	Description	Note
Onboard Parallel Port	Disabled	Choose the printer I/O address.	Default
	378/IRQ7		
	3BC/IRQ7		
	278/IRQ5		
Parallel Port Mode	SPP	The mode depends on your external device that connects to this port.	Default
	EPP		
	ECP		
	ECP+EPP		
If [Parallel Port Mode] is set to [ECP] mode			
ECP Mode use DMA	3	Choose DMA3	Default
	1	Choose DMA1	
If [Parallel Port Mode] is set to [EPP] mode			
EPP Mode Select	EPP 1.9	Select EPP port type 1.9	
	EPP 1.7	Select EPP port type 1.7	Default

3-5.7 Others Optional

	Setting	Description	Note
PWRON After PWR-Fail	On	The system will switch on when power comes back after a power failure.	
	Off	The system will remain off when power comes back after a power failure.	Default
	Former-Sts	The system will return to the state it was in before the power failure when power returns. (i.e: If the system was on, it will switch on again, if it was off, it will remain off)	
Game Port Address	Disabled	Set the I/O base address for the ON board game port under this item.	
	201		Default
	209		
Midi Port Address	Disabled	Set the I/O address for the on board Midi port here.	Default
	330		
	300		
If [Midi Port Address] is set to [330]/[300] mode			
Midi Port IRQ	5	Select the IRQ that the Midi port uses under this them.	
	10		Default

3-6 POWER MANAGEMENT SETUP

The [POWER MANAGEMENT SETUP] sets the system's power saving functions.

CMOS Setup Utility – Copyright (C) 1984-1999 Award Software Power Management Setup		Item Help
ACPI Function	Enabled	Menu Level ▶
x ACPI Suspend Type	S1 (POS)	
Power Management	User Define	
Video Off Method	DPMS	
Video Off In Suspend	Yes	
Suspend Type	Stop Grant	
MODEM Use IRQ	3	
Suspend Mode	Disabled	
HDD Power Down	Disabled	
Cpu Thermal-Throttling	62.5%	
** Reload Global Timer Events **		
Primary IDE 0	Disabled	
Primary IDE 1	Disabled	
Secondary IDE 0	Disabled	
Secondary IDE1	Disabled	
FDD,COM, LPT Port	Disabled	
PCI PIRQ[A-D]#	Disabled	

↑↓→←:Move Enter:Select +/ -/PU/PD:Value F10:Save ESC:Exit F1:General Help
 F5:Previous Values F6:Fail-Safe Defaults F7: Optimized Defaults

After you have completed the Power Management Setup, press [Esc] to return to the Main Menu.



3-6.1 Power Management Controls

Power Management Controls	Setting	Description				Note
ACPI function	Disabled					
	Enabled	ACPI (Advanced Configuration Power Management Interface)				Default
ACPI Suspend Type	S1 (POS)	The system will enter the S1 state during suspend. (Low latency wake up)				
Power Management	User Define	Lets you define the HDD and system power down times.				Default
		Doze timer	Standby timer	Suspend timer	HDD power down	
	Min Saving	1 Hour	1 Hour	1 Hour	15 Min	
	Max Saving	1 Min	1 Min	1 Min	1 Min	
Video Off Method	V/H	Selects the method by which the monitor is blanked.				Default
	Sync+Blank					
	Blank screen					
	DPMS					
Video Off In Suspend	Yes	This determines the manner in which the monitor is blanked.				Default
	No					
Suspend Type	Stop Grant	The system can wake up through external events.				Default
	PwrOn Suspend	The system can only wake up through the Power-Button.				
MODEM Use IRQ	3	Assigns an IRQ# to the modem device.				Default
	3-11, NA					
Standby Mode	Disable					Default
	1Min-1Hour	When the set time has elapsed, BIOS sends a command to the system to enter Standby Mode.				



Power Management Controls (Continued)

Power Management Controls	Setting	Description	Note
HDD Power Down	Disabled		Default
	1-15Min	When the set time has elapsed, BIOS sends a command to the HDD to power down. This turns off the HDD motor.	Some older model HDDs may not support this advanced function.
CPU Thermal-Throttling	87.5%	This item sets the proportion of the original clock frequency to which the CPU will slow do in suspend mode.	
	75.0%		
	62.5%		Default
	50.0%		
	37.5%		
	25.0%		

3-6.2 Reload Global Timer Events

Power Down & Resume Events	Setting	Description	Note
IDE0, IDE1 ➤ Primary ➤ Secondary	Disabled		Default
	Enabled	Enables the PM timers when [No Activity Event] is detected.	
FDD, COM, LPT Port	Disabled		Default
	Enabled	Enables the PM timers when [No Activity Event] is detected.	
PCI PIRQ [A-D]#	Disabled		
	Enabled	The system monitors these elements for activity. The system will resume if [IRQ activity] is detected.	Default

3-7 PNP/PCI CONFIGURATION SETUP

This option sets the Motherboard's PCI Slots.

CMOS Setup Utility – Copyright (C) 1984-1999 Award Software
 PnP/PCI Configurations

PNP OS Installed No Reset Configuration Data Disabled		Item Help Menu Level ▶
Resources Controlled By Auto (ESCD) x IRQ Resources Press Enter		
PCI/VGA Palette Snoop Disabled Assign IRQ For USB Enabled		
Slot1 IRQ Assignment Auto Slot2 IRQ Assignment Auto Slot3 IRQ Assignment Auto		

↑↓→←:Move Enter:Select +/-/PU/PD:Value F10:Save ESC:Exit F1:General Help
 F5:Previous Values F6:Fail-Safe Defaults F7: Optimized Defaults



Note: Starred (*) items will disappear when the [Resources Controlled By] option is set to [Auto].

After you have completed the PCI Slot Configuration, press [Esc] and follow the instructions on your screen to save your settings or exit without saving.

3-7.1 PNP/PCI Configuration Controls

PNP/PCI Controls	Setting	Description	Note
PnP OS Installed	Yes	Set this field to [Yes] if you are running Windows 95, which is PnP compatible.	
	No	If the OS you are running does not support PnP configuration.	Default (If there is any doubt, set this field to [No])
Reset Configuration Data	Disabled	Retain PnP configuration data in BIOS.	Default
	Enabled	Reset PnP configuration data in BIOS.	
Resources Controlled By	Manual	BIOS does not manage PCI/ISA PnP card IRQ assignment. Requires to assign IRQ-# and DMA-# to PCI or ISA PnP manually. IRQ-3,4,5,7,9,10,11,12,14,15 assigned to: _ DMA-0,1,3,5,6,7 assigned to: _	
	Auto (ESCO)	The Plug-and-Play BIOS auto manages PCI/ISA PnP card IRQ assignment automatically.	Recommended
If [Resources Controlled By] is set to [Manual]			
IRQ-# and DMA-# assigned to:	PCI/ISA PnP	Choose IRQ-# and DMA-# assigned to PCI/ISA PnP card.	IRQ-3,4,5,7,9,10,11,12,14,15 DMA-0,1,3,5,6,7
	Legacy ISA	Choose IRQ-# and DMA-# assigned to Legacy ISA card.	IRQ-3,4,5,7,9,10,11,12,14,15 DMA-0,1,3,5,6,7
Under this item the user can assign an IRQ to a PCI slot. However, there under some conditions the IRQ will not be assigned as selected under this item:			
<ol style="list-style-type: none"> 1. IRQs 0, 1, 2, 6, 8, 13 can NOT be assigned, because they are fixed. 2. IRQs 5, 9, 10, 11 are available 3. IRQs 3,4,7,12,14 and 15 will only be assigned if they are free. See the table below on how to free them: 			

PNP/PCI Configuration Setup (Continued)

PNP/PCI Setup	Setting	Description	Note
Interrupt Line	How to set the BIOS to release the IRQ to the PnP Interrupt pool:		
	PnP / PCI configuration	Integrated Peripherals	
IRQ 15	IRQ 15: PCI / ISA PnP	On-Chip Secondary PCI IDE:	disabled
IRQ 14	IRQ 14: PCI / ISA PnP	On-Chip Primary PCI IDE:	disabled
IRQ 12	IRQ 12: PCI / ISA PnP	<i>Interrupt 12 will be released by the PnP BIOS automatically if the PS/2 Mouse Port is not used.</i>	
IRQ 7	IRQ 7: PCI / ISA PnP	Onboard parallel port:	disabled
IRQ 4	IRQ 4: PCI / ISA PnP	Onboard Serial port 1:	disabled
IRQ 3	IRQ 3: PCI / ISA PnP	Onboard Serial port 2:	disabled
4. Your OS may reassign another interrupt to a PCI slot after BIOS passes control to the OS, especially if you use Windows 95, 98 or NT.			
Assign IRQ For USB	Disabled	BIOS will assign IRQ for USB port.	
	Enabled	BIOS won't assign IRQ for USB port.	Default
5. Your OS may reassign another interrupt to a PCI slot after BIOS passes control to the OS, especially if you use Windows 95, 98 or NT.			
Slot 1/2/3 Use Auto IRQ NO.	Set to Auto	the BIOS will use IRQs Automatically.	Default

3-7.2 MULTI I/O ADDRESSES

Default settings for multi-I/O addresses are as follows:

Port	I/O Address	IRQ	Status
LPT1	378H	7	ECP/EPP
COM1	3F8H	4	
COM2	2F8H	3	



Warning: If a default I/O address conflicts with other I/O cards such as sound card, you must change one of the I/O addresses to remedy to this address conflict. (I/O addresses can be adjusted from the BIOS Setup Utility)

3-8 PC HEALTH STATUS

This option sets the Motherboard's PC Health Status.

CMOS Setup Utility – Copyright (C) 1984-1999 Award Software
 PC Health Status

CPU Warning Temperature Disabled Current System Temp. 25 °C / 77 °F Current CPU Dio Temperature 40 °C / 104 °F Current CPUFAN Speed 5192 RPM Current CHSFAN Speed 0 RPM Current PWRFAN Speed 0 RPM Vcore 2.04 V VTT 1.50 V 3.3V 3.31 V + 5V 5.02 V +12V 12.03 V VBAT (V) 3.07 V 5VSB (V) 5.45 V	Item Help <hr/> Menu Level ▶
--	-----------------------------------

↑↓→←:Move Enter:Select +/-/PU/PD:Value F10:Save ESC:Exit F1:General Help
 F5:Previous Values F6:Fail-Safe Defaults F7: Optimized Defaults



Note: Starred (*) items will disappear when the [Resources Controlled By] option is set to [Auto].

3-8.1 CPU Device Monitoring

CPU Device Monitoring	Setting	Description	Note
CPU Warning Temperature	Disabled		Default
	50°C/122°F	Set CPU temperature from 50°C to 70°C. The CPU will slow down when CPU temperature goes beyond the preset value. The CPU will continue to run slow until the temperature returns back within the safe range.	
	53°C/127°F		
	56°C/132°F		
	60°C/140°F		
	63°C/145°F		
	66°C/150°F		
	70°C/158°F		
	75°C/167°F		
	80°C/176°F		
	85°C/185°F		
	90°C/194°F		
	95°C/203°F		
100°C/212°F			
110°C/230°F			
120°C/248°F			
Current System Temp.	°C/°F	Show the current status of the system temperature.	
Current CPU Dio Temperature	°C/°F	Show the current status of CPU temperature.	
Current CPUFAN Speed	°C/°F	Show the current status of CPU Fan	
Current CHSFAN Speed	°C/°F	Show the current status of the chassis Fan	
Current PWFAN Speed	°C/°F	Show the current status of the Power Fan	
Vcore, VTT, 3.3V, +5V, +12V, VBAT, 5VSB	V	Show the current voltage status.	

3-9 LOAD OPTIMIZED DEFAULTS

Select the [Load Optimized Defaults] option from the Main Menu to load the system values you have previously saved. This option is recommended if you need to reset the system setup and to retrieve the old values.

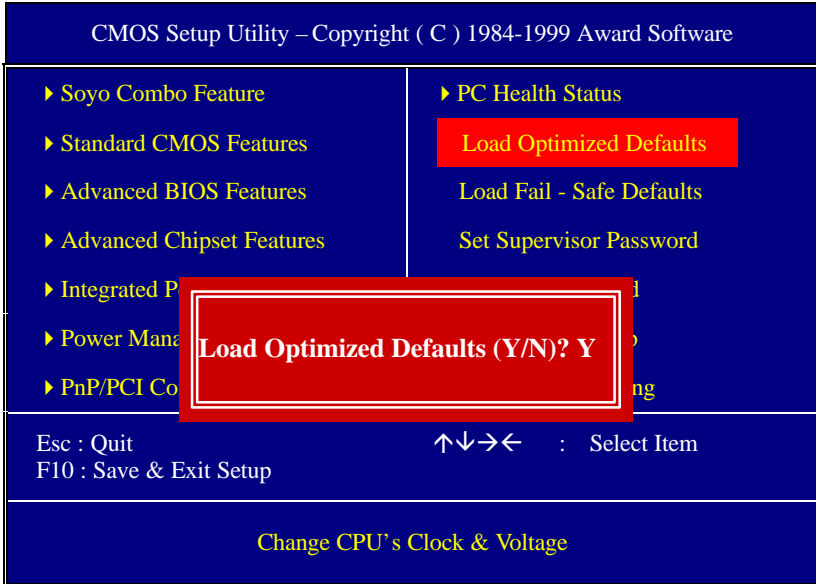

Type [Y] to use the Setup Defaults followed by [Enter] or otherwise [N] to return to the Main Menu and keep current values.



Warning: If you run into any problem after changing the BIOS configuration, please load the SETUP DEFAULTS for stable performance.

3-10 LOAD FAIL-SAFE DEFAULTS

Select the [Load Fail-Safe Defaults] option from the Main Menu to load the system values you have previously saved. This option is recommended if you need to reset the system setup and to retrieve the old values.

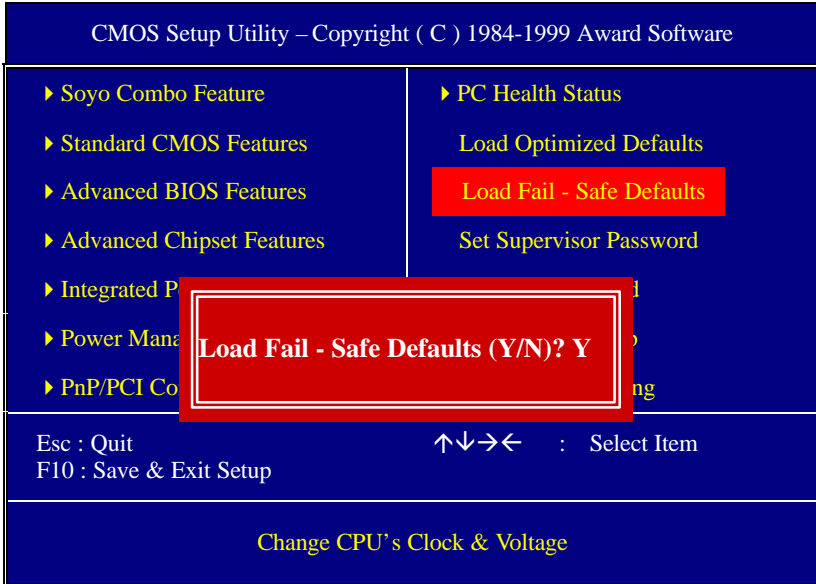

Type [Y] to use the Setup Defaults followed by [Enter] or otherwise [N] to return to the Main Menu and keep current values.



Warning: If you run into any problem after changing the BIOS configuration, please load the SETUP DEFAULTS for stable performance.

3-11 SUPERVISOR PASSWORD

Based on the setting you have made in the [Security Option] of the [BIOS FEATURES SETUP] section, the password prevents access to the system or the setup program by unauthorized users. Follow this procedure to set a new password or disable the password:

1. Choose [BIOS FEATURES SETUP] in the Main Menu and press [Enter]. Select the [Security Options] item and set the field to:
 - a. [System]: The password is required every time the system is booted. This means only a person who knows the password can use this computer.
 - b. [Setup]: The password is required only when you attempt to enter the BIOS Setup program.

2. Choose [SUPERVISOR PASSWORD] from the Main Menu and press [Enter]. The following prompt appear:

Enter Password:



Warning: If you forget or lose the password, the only way to access the system is to set jumper JP5 to clear the CMOS RAM. All setup information is lost and you must run the BIOS setup program again.



Note: If you do not wish to use the password function, press [Enter] directly and the following message appears:

Password Disabled!!

3. Enter your new password and press [Enter]. The following message appears, prompting to confirm the new password:

Confirm Password:

4. Re-enter your password and then press [Enter] to exit to the Main Menu.

This diagram outlines the password selection procedure:

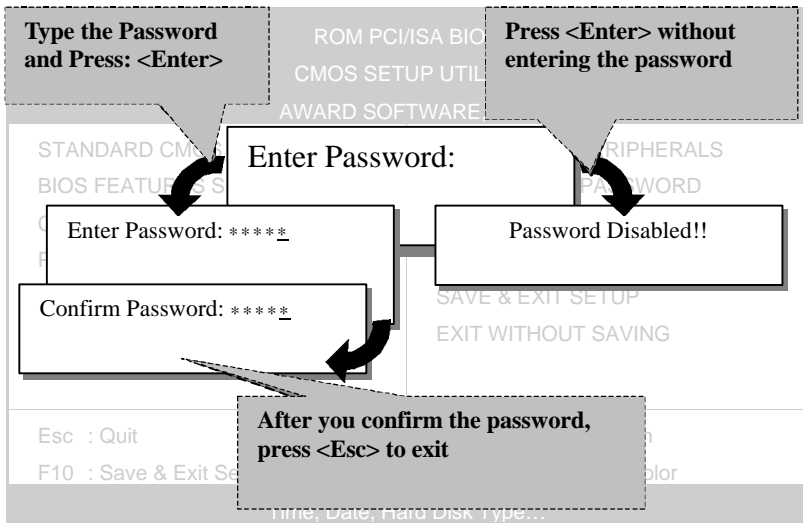

3-12 USER PASSWORD

When the user password option is on, you are not allowed to change any setting in the [CMOS SETUP UTILITY] except for changing the user's password.

The password setting procedure is similar to that for the [SUPERVISOR PASSWORD] (Refer to section 3-9).

3-13 IDE HDD AUTO DETECTION

This Main Menu function automatically detects the hard disk type and configures the [Standard CMOS Features] accordingly.

CMOS Setup Utility – Copyright (C) 1984-1999 Award Software
 IDE Primary Master

IDE HDD Auto-Detection Press Enter IDE Primary Master Auto Capacity 0 MB Access Mode Auto 0 Cylinder 0 Head 0 Precomp 0 Landing Zone 0 Sector 0	Item Help Menu Level ▶
---	-------------------------------

↑↓→←:Move Enter:Select +/-/PU/PD:Value F10:Save ESC:Exit F1:General Help
 F5:Previous Values F6:Fail-Safe Defaults F7: Optimized Defaults



Note: This function is only valid for IDE type of hard disk drives.

Chapter 4

THE SOYO CD

Your SY-7IWB Motherboard comes with a CD-ROM labeled "SOYO CD." The SOYO CD contains (1) the user's manual file for your new Motherboard, (2) the drivers software available for installation, and (3) a database in HTML format with information on SOYO Motherboards and other products.

Step 1. Insert the SOYO CD into the CD-ROM drive
The SOYO CD will auto-run, and the SOYO CD Start Up Menu will be shown as below.



(SOYO CD Start Up Program Menu)

If you use Windows 95/98, the SOYO CD Start Up Program automatically detects which SOYO Motherboard you own and displays the corresponding model name.

Step 2. Read SOYO [7IWB] Manual

Click the **Read Manual** button to open the user's manual file of your Motherboard.

Please note that if the Start Up program was unable to determine which SOYO Motherboard you own, the manual selection menu will pop up, as shown below. Then select the user's manual file that corresponds to your Motherboard model name and click **OK**.

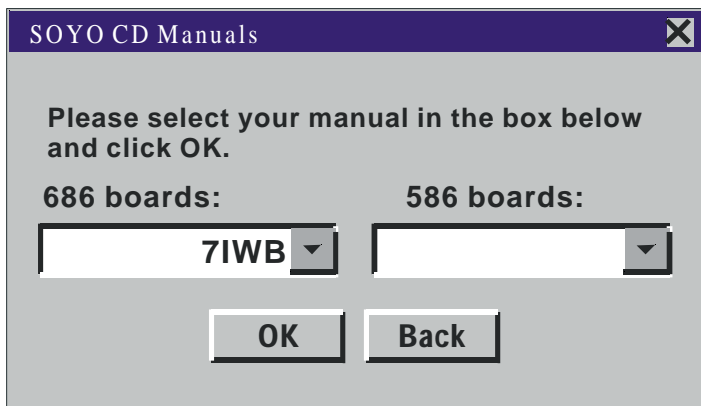

(Manual Selection Menu)

The user's manual files included on the SOYO CD can be read in PDF (Postscript Document) format. In order to read a PDF file, the appropriate Acrobat Reader software must be installed in your system.

Note: The Start Up program automatically detects if the Acrobat Reader utility is already present in your system, and otherwise prompts you on whether or not you want to install it. You must install the Acrobat Reader utility to be able to read the user's manual file. Follow the instructions on your screen during installation, then once the installation is completed, restart your system and re-run the SOYO CD.

Step 3. Install Drivers

Click the **Install Drivers** button to display the list of drivers software that can be installed with your Motherboard. The Start Up program displays the drivers available for the particular model of Motherboard you own. We

recommend that you only install those drivers. If you use Windows NT, only select the drivers listed here.

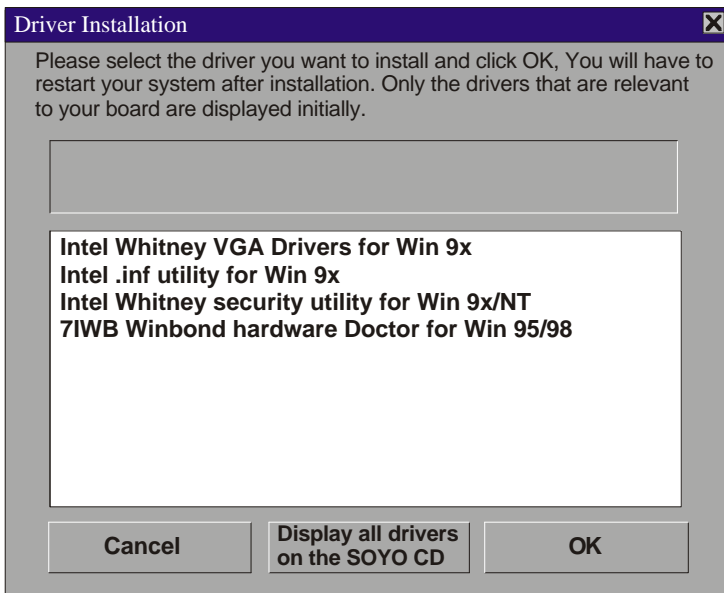

(Driver Installation Menu)

However, to display the list of all drivers software available with SOYO Motherboards, click the *Display all drivers on the SOYO CD* button. Please make sure to install only the drivers adapted to your system, or otherwise this may cause system malfunctions.

A short description of all available drivers follows:

➤ **INTEL Whitney VGA Drivers for Win 9x**

In order to be able to make use of the integrated VGA function in your Whitney chipset, you will need to install this driver first. For Windows 95/98 only.

➤ **INTEL Whitney .inf utility for Win 9x**

Windows 95 and 98 will not recognize the new INTEL Whitney chipset properly. To update the necessary .inf files that will help Windows recognize the Whitney chipset, please run this utility.

➤ **INTEL Whitney security utility for Win 9x/NT**

This utility makes use of the random number generator in the FWH of your 810/820 chipset. for Win 95/98/NT.

➤ **7IWB Winbond hardware Doctor for Win 95/98**

Your motherboard comes with hardware monitoring function. By installing this utility Temperature, Fan speed and Voltages can be monitored. It is also possible to set alarms when current system values exceed or fall below pre-set values.

Select which driver you want to install and click **OK**, or click **Cancel** to abort the driver installation and return to the main menu.

Note: Once you have selected a driver, the system will automatically exit the SOYO CD to begin the driver installation program. When the installation is complete, most drivers require to restart your system before they can become active.

Step 5. Check the Latest Releases

Click the 'Check the latest Releases' button to go the SOYO Website to automatically find the latest BIOS, manual and driver releases for your motherboard. This button will only work if your computer is connected to the internet through a network or modem connection. Make sure to get your modem connection up before clicking this button.

Step 6. Enter the SOYO CD

Click the **Enter SOYO CD** button to enter the SOYO HTML database. The Start Up program will activate the default HTML browser installed on your system (for example, Internet Explorer or Netscape) to display the contents of the SOYO CD.

The SOYO CD contains useful information about your Motherboard and other SOYO products available. For your convenience, this information is available in HTML format, similar to the format widely used on the Internet.



Note: If no HTML browser is installed on your system, the Start Up program will prompt you on whether or not you would like to install the Internet Explorer* browser. Click YES to install the HTML browser. After the installation is complete, please restart your system. Then re-run the SOYO CD and you will be able to browse the SOYO HTML database.

(* *Internet Explorer is a Microsoft Trademark*)

Chapter 5

CRYSTAL AUDIO DRIVER INSTALLATION

Installing Crystal Audio Drivers under windows 9x

1. Open Device Manager.
2. PCI Multimedia Device will have a yellow marker the first time the operating system is installed.
3. Select "Properties" on the yellow marker.
4. Select the "Driver" tab.
5. Click on "Update Driver"
6. Select the following directory:
D:\driv-all\crystal>window9x\image
and click OK. You will need at least Windows OSR2 to complete the WDM installation.
7. The entry that will show up in the Sound, Video, and Game Controllers is: Crystal WDM Audio Codec.
8. A little Sound Icon appears on the Task Bar upon completing the driver installation.

Uninstalling/Re-Installing Crystal Audio Drivers

1. Open Device Manager.
2. Remove Crystal WDM Audio Codec entry in the Sound, Video, and GameControllers section. Crystal is not the owner of the game controller on this audio solution.
3. Delete Crystal INF in c:\windows\inf\other
4. Restart your PC for Plug and Play to reinitialize your system.

Known Limitations

1. Clicking the Stop button causes loud pops while playing Midi through Media Player, when Headphone control is used.
2. Playing any wave using the Dsound application causes a loud pop when the Play button is clicked.
3. After Remove/Refresh, no software wavetable audio is available after a reboot.
4. The Play and Stop button cause loud pops while playing wave through the Media player.
5. There may be some feed back noise when Microphone boost is enabled.
6. A reboot may be required to play MIDI audio after the initial installation of the driver.
7. Panning Headphone and Wave balance in the Output mixer while playing a Wave/CD/Line-in signal causes a pop.

Special Design Considerations

- 1.The Headphone does not mute the audio when the headphone slider is adjusted to the minimum value.
- 2.SW Synth slider jumps to max value, when Synth state is switched from Stop to Play or viceversa.
- 3.Master Volume levels are quite low when compared to Headphone volume levels.
- 4.Fastforward and Rewind Controls in the Media Player can not enabled.
- 5.When resuming from sw wavetable playback, midi is paused.
- 6.Digital CD Audio is recorded by loopback mux selection.
- 7.Mono Mix volume is low.
- 8.Some Dos games do not run in a Dos Box. This support is provided by the Microsoft legacy Audio emulator.

***Note:** The above limitations list is as provided by the codec manufacturer, SOYO will provide customers with new driver releases through the SOYO website as soon as they are released by the manufacturer.*

Installing Crystal Audio Drivers for Windows NT

1. Double click the MULTIMEDIA icon in the control panel. The Multimedia Properties windows will appear. Click on the Devices tab and press the Add button.
2. Select "Unlisted or Updated Drivers" from the list of drivers in the Add window by placing the mouse pointer over it and clicking the left mouse button. Press the OK button.
3. The Install Driver dialog box will appear and request the path of the location of the drivers to be installed. Enter D:\driv-all\crystal\NT (where D: is your CDROM drive) If the installation fails, first copy all the files in the above directory to your harddisk and give that directory to NT.
4. The label "SoundFusion(tm)" is displayed on the dialog box. Press OK to continue with the installation.
5. Windows NT will display a dialog box asking you to restart your system.

Press the Restart Now button to complete the installation.

Uninstalling or Updating Crystal Audio Drivers

1. Double click on the MULTIMEDIA icon in the control panel. Select the Devices tab from the Multimedia properties window.
2. Double click on the Audio Devices entry from the Multimedia devices list. Select the driver by placing the mouse pointer over the label "Audio for SoundFusion(tm)" and clicking the left mouse button.
3. Press the REMOVE button.
4. A question box will appear to verify your decision. Press the YES button.
5. Windows NT will display a dialog box asking you to restart your system. Press the Restart Now button to complete the Un-installation.

