

D@eBox

User's Manual

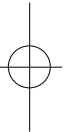

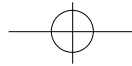

CONTENTS

Starting	3
1. How to use this manual	3
2. Check Items	4
3. System Setting	4
Ch1.System Configuration	6
1. Front configuration	6
2. Rear configuration	7
Ch2. Start to Install	8
1. Plugging the mouse/keyboard	8
2. Plugging the Power Cord	9
3. Plugging the RJ11 Phone line	1
Ch3. System Disassembling & assembling	1
1. Disassemble Drawing	1
2. Upgrading Memory and Replacing Backup Battery	1
3. Assemble Drawing	2
Ch4.Monitor	2
1. Factory Preset Display Mode	2
2. Technical Specification	2
3. OSD Program Description	2
Ch5.Mother Board	2
1. Specification	2
2. Layout	3
3. Set Jumper	3
Ch6.Bios setup	3



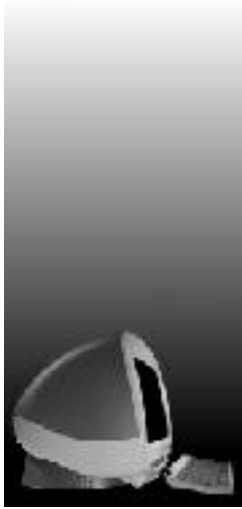
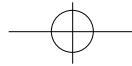



Starting

How to use this manual

It is very easy to install the computer system with this manual. Please read this guide carefully, before you install the computer system.

 For your safety, remember to turn off the system and t disconnect all the cords and cables before opening the systere chassis.

 To avoid electric shock, do not open the monitor frame chassis.

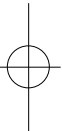
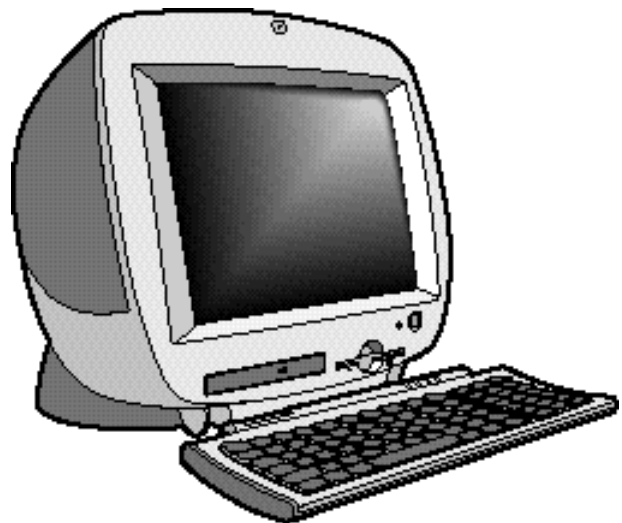

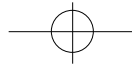

2. Check Items

Check your boxes for the following items.



System

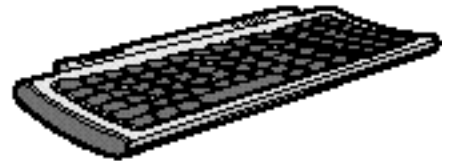

Keyboard

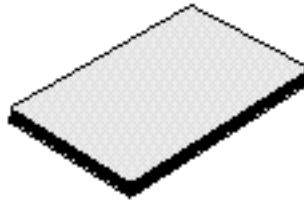

User's Manual

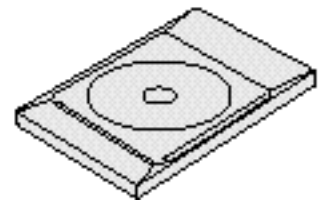

CD-ROM Title

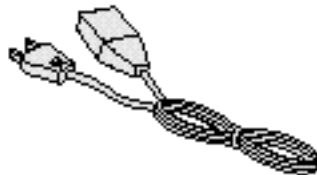

Power cord



Mouse



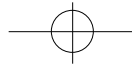

3. System Setting

Operate the PC on a sturdy level surface such as desk or table.

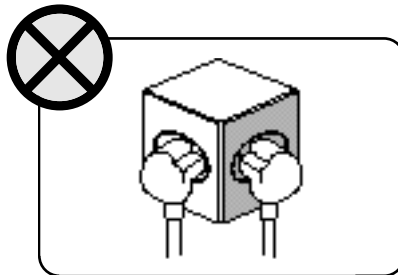

Please do not overload the power socket.

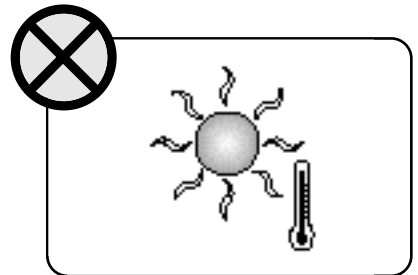

Place the system away from high temperature and direct sunlight.

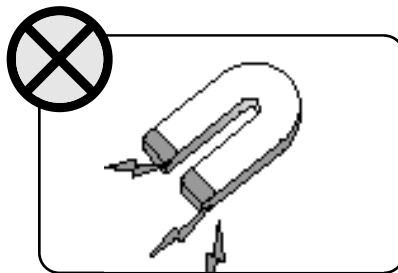

Do not place magnetic objects close to the system.

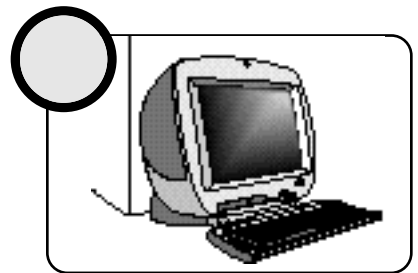

Keep distance between the system and the wall.

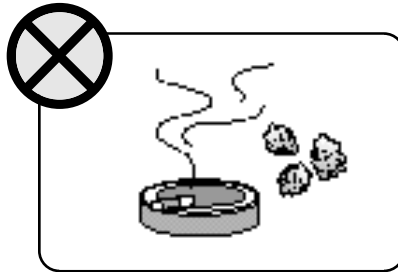

Avoid dust or moisture from the system.

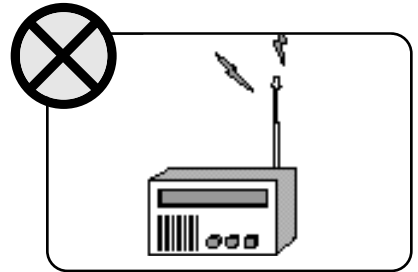

Place the system away from radio or any electronic receivers.



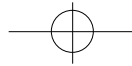

Ch.1 System Configuration

1. Front configuration

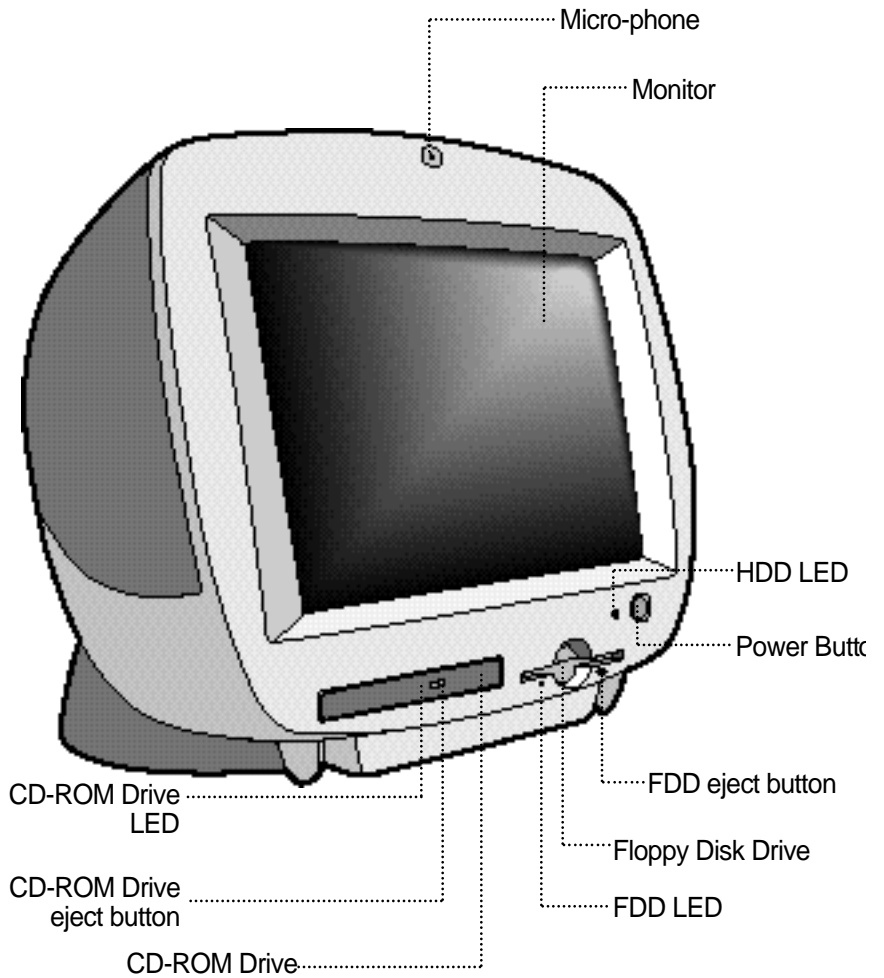

[figure.2]

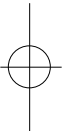

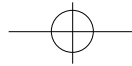

2. Rear Configuration

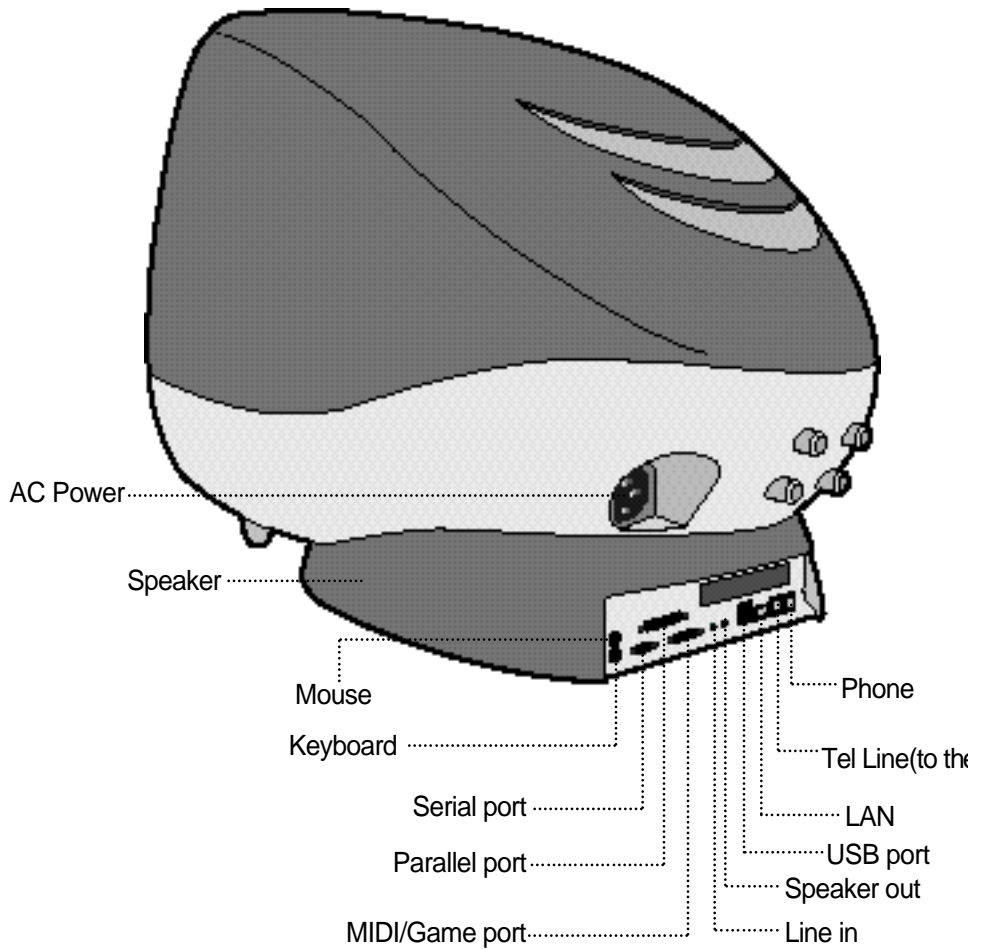

[figure.3]



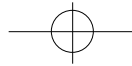

D@eBox

Ch.2 Start to Install

1.Plugging keyboard and mouse

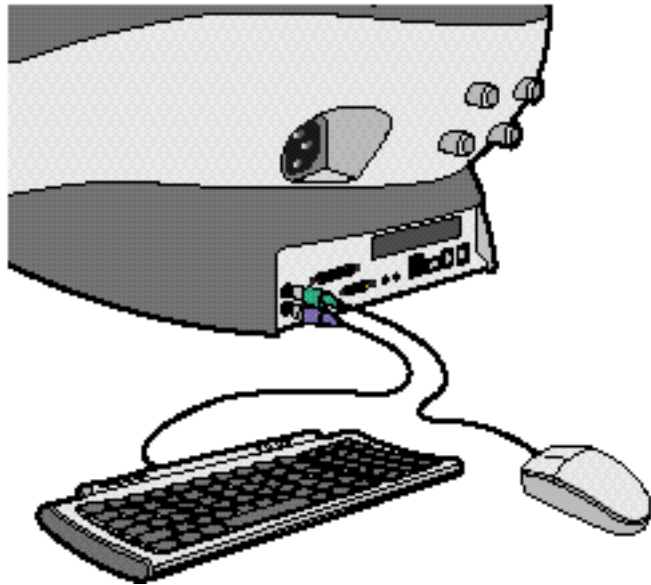

[figure. 4]

Keyboard and mouse connector is on the rear panel.
Connect the keyboard to the keyboard connector colored blue.
Connect the mouse to the mouse connector colored green.



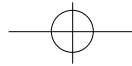

2.Plugging the power cord

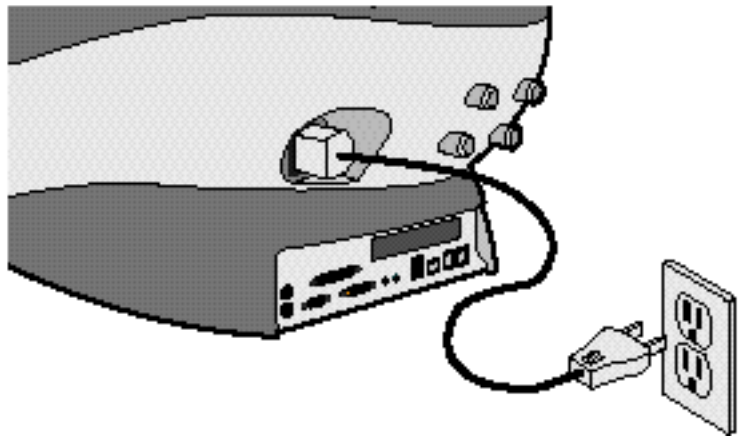

[figure. 5]

D@eBox Computer System applies both 110/220V power range without any setting action.

Just plug the power cord into your PC and connect the cord to the grounded outlet.



Do not connect power cable to the power outlet until you finish all the preceding steps.



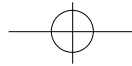

3.Plugging the RJ11 Phone line

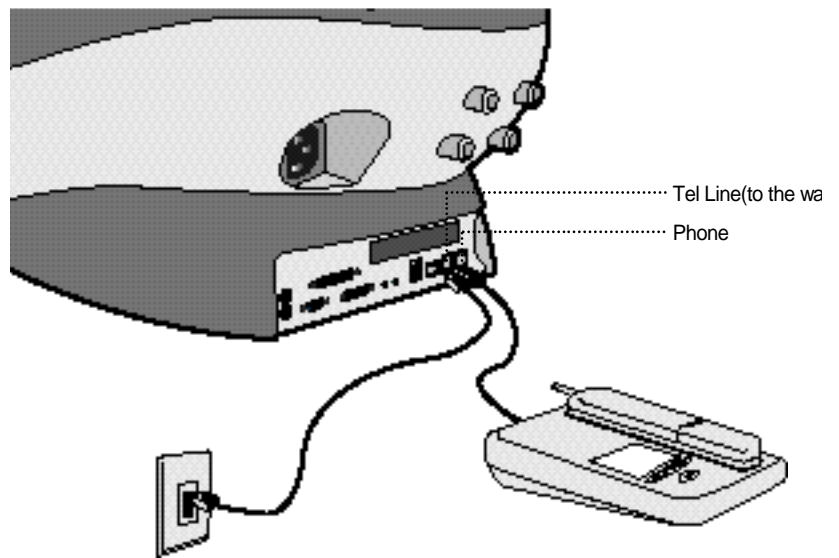

[figure. 6]

With telephone line connectivity, you can network PCs located anywhere in the same building where you have access to jacks from a single telephone line.

Connect phone jack and telephone line of the PCs you want to network with RJ11 telephone line.



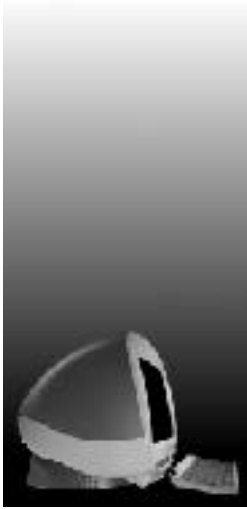
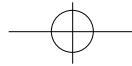

CH3. System disassemble & assemble

This model provides many convenient options that gives you more system flexibility. This chapter describes how to install optional part inside the computer and remove and replace the computer cover and expansion-cage.

Are you ready?

For easier work with inside your computer, please check out you have proper lighting and a clean work space. If you temporarily disconnect cables or remove expansion cards, make sure you note the position of the connectors and slots so that you can reassemble the system correctly.

Rules for safety

1. Remove all the AC power source from your computer and all peripherals.
2. Connection any telephone or telecommunication lines from the computer may cause personal injury or electric shock.
3. Please wait 5 seconds after turning off the computer before disconnecting the peripheral or removing the component when you are disconnecting a peripheral from the computer or removing a component from the system board, to avoid possible damage to the system board.
4. Touch an unpainted metal surface on the computer chassis, such as the power supply, before touching anything inside your computer.

To avoid static electricity that might harm internal components, please touch an unpainted metal surface on the computer chassis periodically. Touching components or contacts on a card or pins on a chip might cause damage of components.

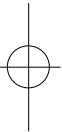

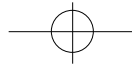

1. Disassembling Drawing

This section describes how to disassemble PC for adding RAMs, changing battery, installing modem card etc.

It is very important to check if the AC power cable is removed from PC before you disassemble your PC. If the AC power cable is removed from your PC, you may start disassembling.

Opening the Computer

- 1) Place a soft stuff (example : towel, cloth etc.) on the front of computer.

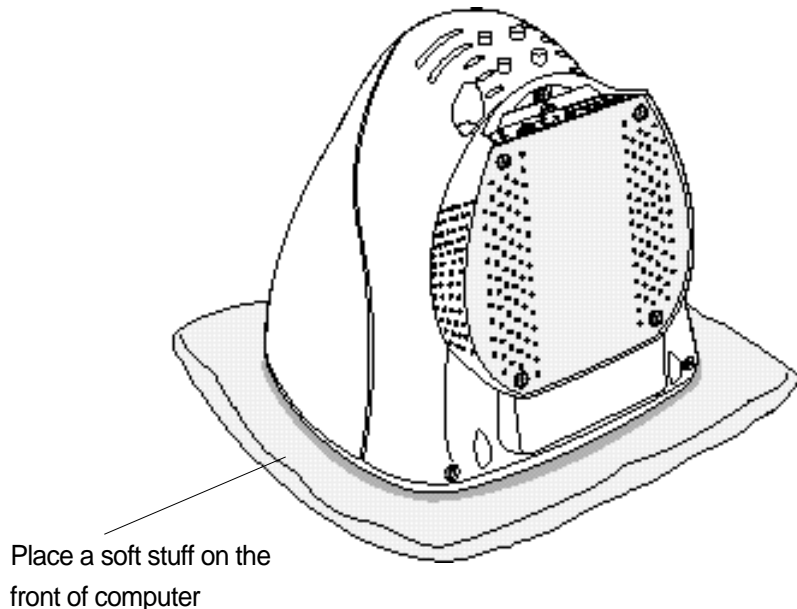

[figure. 7]



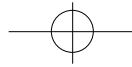

2) As you could see [figure.8], there are 5 screws and loose 4 of them which is indicated as ① to separate the thin plate.

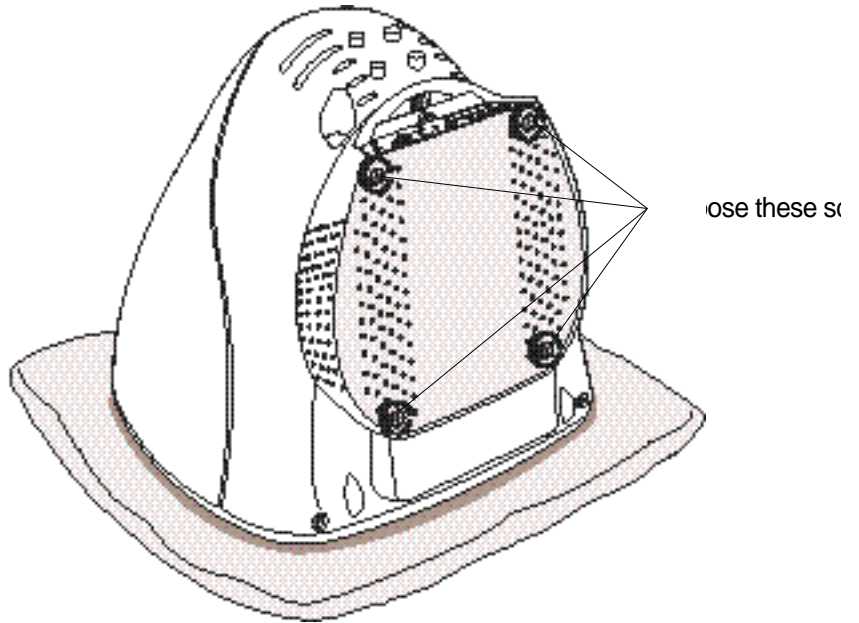

[figure. 8]



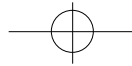

3) After you separate the thin plate as you can see in [figure. 9], loose screws indicated as ② to separate transparent case ③, first remove the speaker cable (④) which is connected to speaker at this moment.

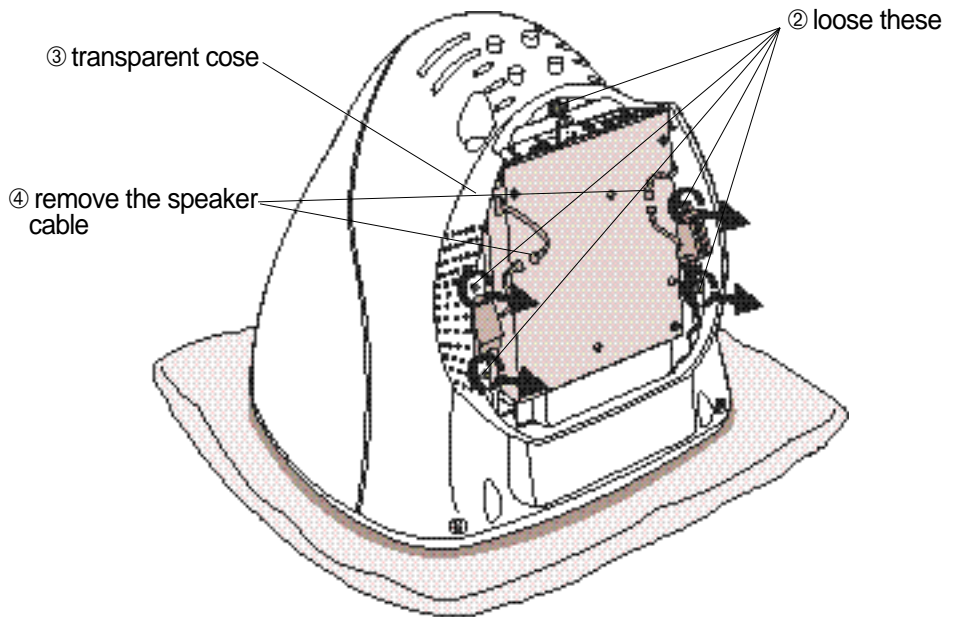

[figure. 9]



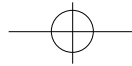

4) After you separate transparent case, loose 3 screws indicated as ⑤ t separate the body of PC. [figure. 10,11] shows how you can separat body and monitor. Please be cautious when you pull out the bod because the body and monitor is connected with cable. If you pull out the body little bit first then remove the cable, there will be no problem [figure. 12] shows after the monitor and body is separated.

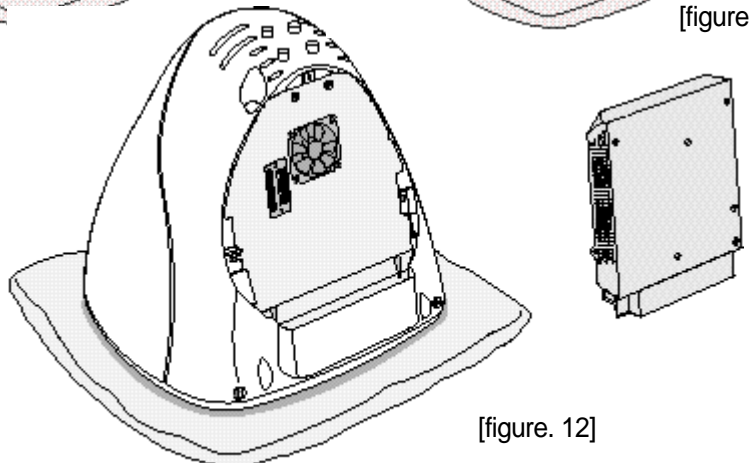
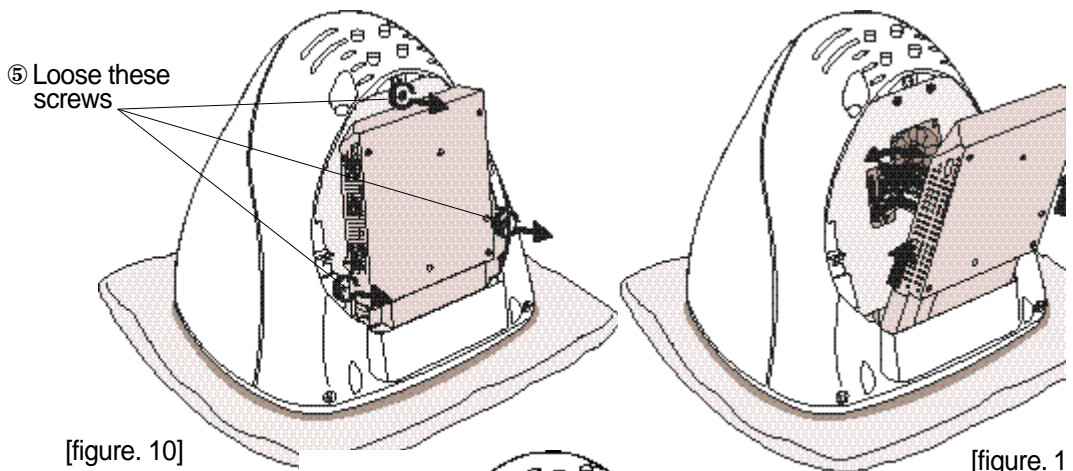

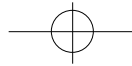

5) Description for each part of main board and interface board locate beneath the monitor.[figure. 13]

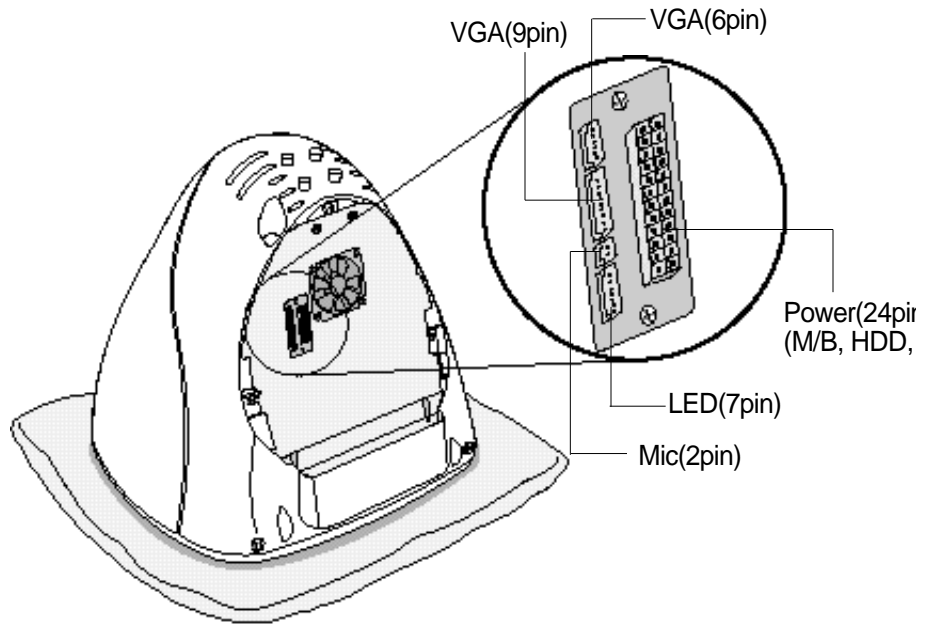

[figure. 13]



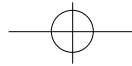

2. Upgrading Memory and Changing the backup Battery

This section is to describe that upgrading memory and Changing the backup battery.

Upgrading Memory

This model has 64 Mbytes memory as a default and you can upgrade maximum 256 Mbytes when you need.

How to install

- 1) Locate the two clips that hold the memory module in place. One clip holds the left edge of the module and the other clip holds the right edge.
- 2) Push both clips away from the socket.



- 3) Position the DIMM over the socket so that the notch at the bottom of the module lines up over the divider in the socket. As shown in the next picture, match the wide part of the module to the wide part of the opening in the socket.

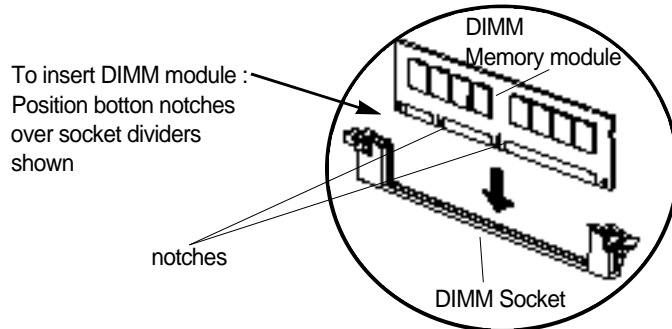

- 4) Push the module straight down into the socket.



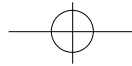

How to remove

- 1) Locate the two clips that hold the memory module in place. One clip holds the left edge of the module and the other clip holds the right edge
- 2) Push one clip away from the module. Then, while holding the module with one hand, push the other clip away from the module.

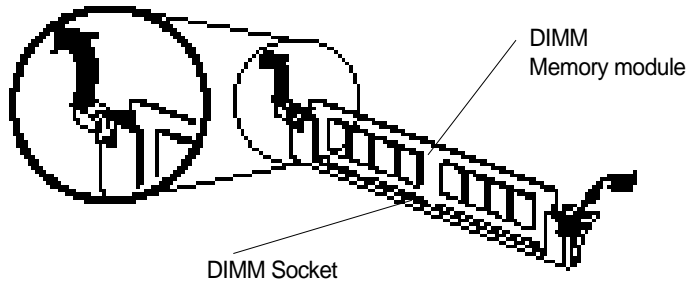

- 3) Lift the module out of the socket.



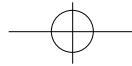

Changing the Battery

- 1) A mercury cell is located in the center of main board to keep setup data of CMOS
- 2) If you see the case part, you could find protruding part(②). Keep pushing this protruding part and remove existing cell then install new cell. If you are using metallic driver to push, try not to touch any other part with the metallic tool.

- ☞ There is the danger of an explosion if the battery is incorrectly replaced.
- ☞ Replace the battery with the same or equivalent type recommended by the manufacturer.
- ☞ Discard used batteries according to the battery manufacturer's instructions.

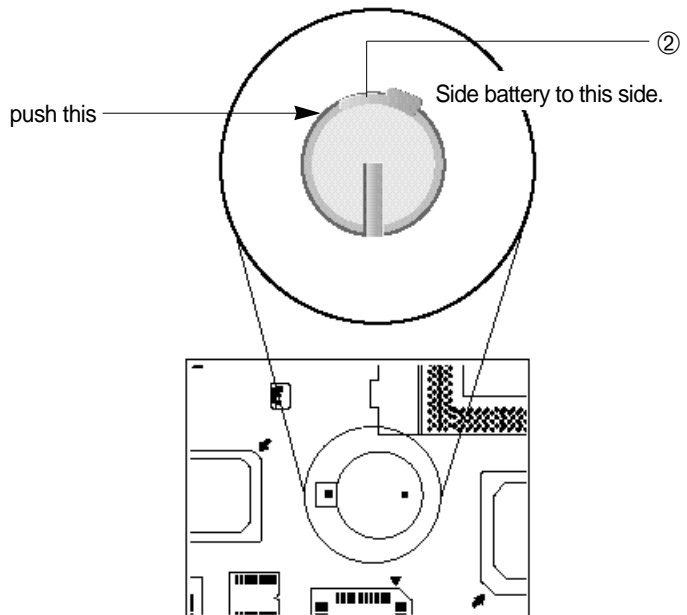

[figure. 14]



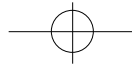

3. Assembling Drawing

- 1) You can assemble PC with reverse order of disassembling. First of all please check if all part is attached firmly.
- 2) Connect body and monitor with cable.
- 3) Put in PC body after fitting ① and ②.(FDD,CDROM is front)[figure. 15]
- 4) Drive these screw. [figure. 16]

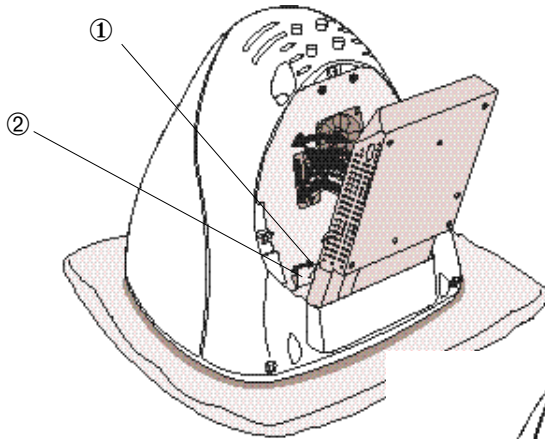

[figure. 15]

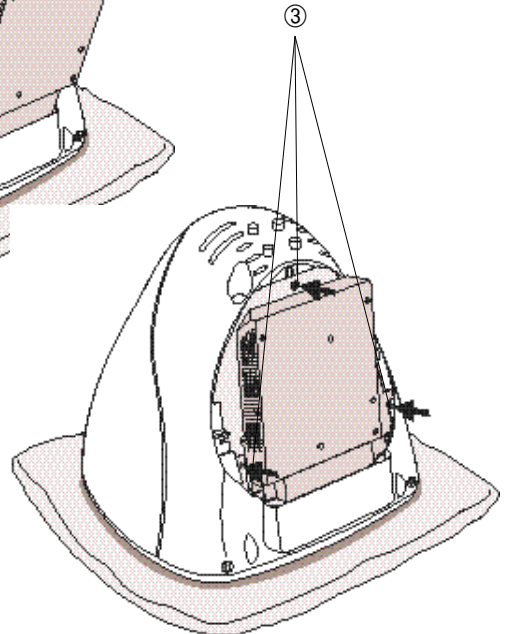

[figure. 16]



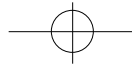

5) After finish assembling body part, combine transparent case like [figure 17], drive these crews (④), and also connect to the speak cable(⑤).

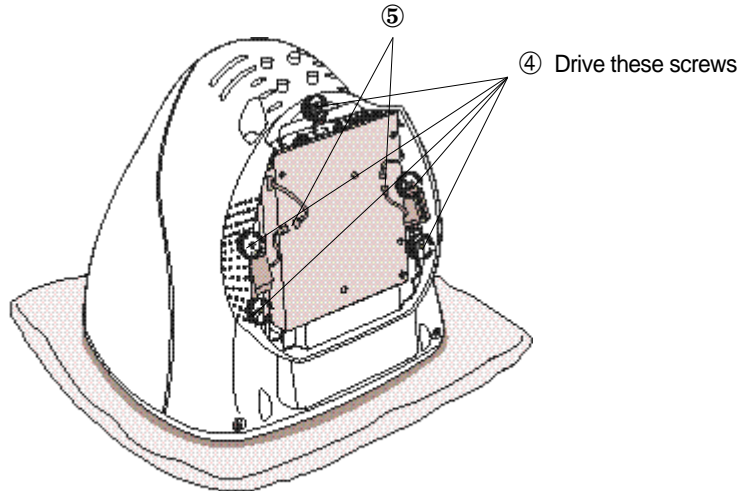

[figure. 17]

6) Fit the thin plate shown [figure. 18] and drive these screw (⑥).

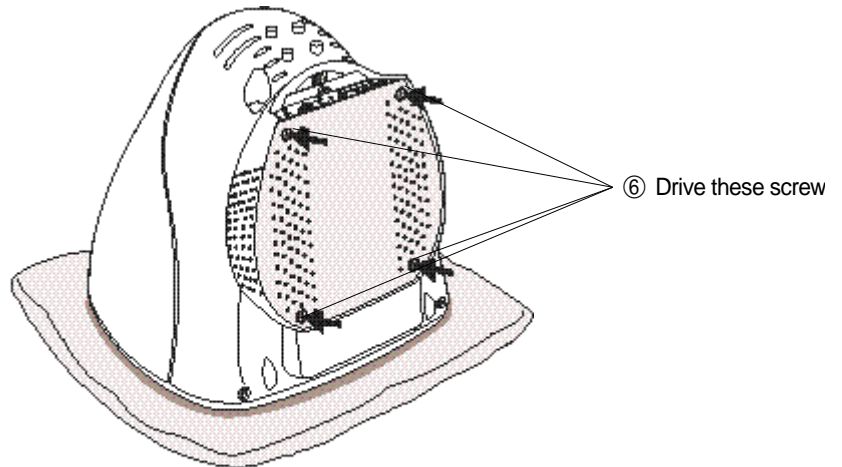

[figure. 18]



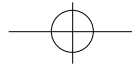

7) Stand your PC, connect the power cable and turn on.



[figure. 19]



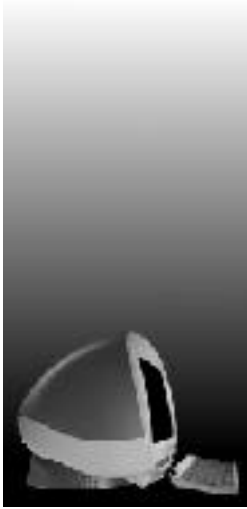
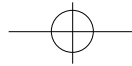

Ch.4 Monitor

1.Factory preset display mode

Preset mode	Resolution		Frequency	
	H(Pixel)	V(Line)	H(KHz)	V(Hz)
VGA	640	350	31.5	70
	720	400	31.5	70
	640	480	31.5	60
VEGA	640	480	37.5	75
	640	480	43.2	85
	800	600	37.9	60
	800	600	46.9	75
	800	600	53.6	85
	1024	768	48.3	60
	1024	768	68.7	85
	1280	1024	64.0	60

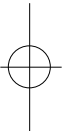

2.Specifications

Item	Specifications
Size	15"(14")viewable
Dot Pitch	0.28mm
Max Resolution(HXV)	1280X1024
Horizontal frequency	30~69KHz
Vertical frequency	50~120Hz
Video Dot Rate	110MHz
Active Display Area	Preset 265X190mm Full 278X208mm
Features	Invar shadow mask AS(Anti-Static)coating



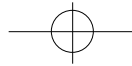

3.OSD CONTROL PROGRAM

General

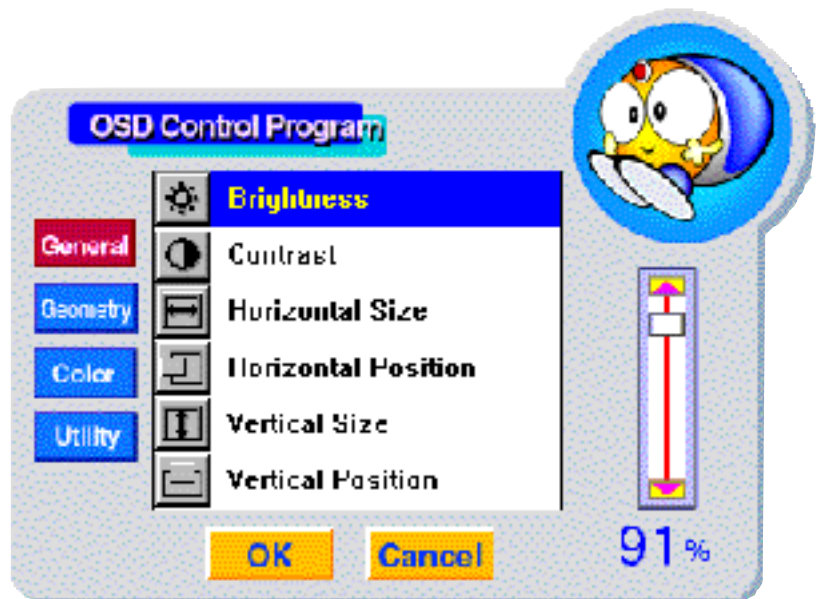

[figure. 20]

- Brightness : Adjust the brightness of the entire image.
- Contrast : Adjust the contrast of image, the difference between light and dark areas on the screen.
- Horizontal Size : Adjust the display width (Horizontal size).
- Horizontal Position : Adjust the position of the display horizontally (Left or Right).
- Vertical Size : Adjust the display height (Vertical size).
- Vertical Position : Adjust the position of the display vertically (Up or Down).



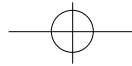

Geometry

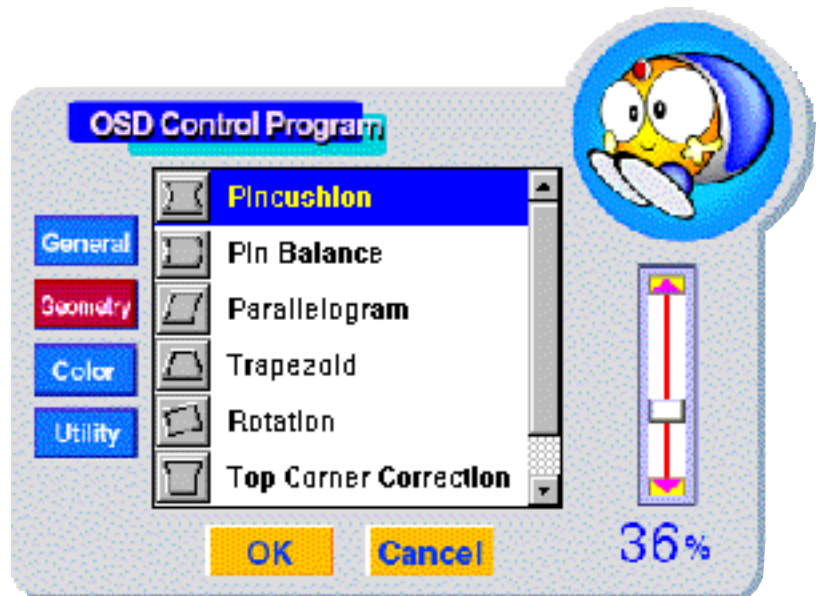

[figure. 21]

- Pincushion : Adjust the left and right margins for more convex or more concave margins.
- Pin Balance : Adjust the side balance when the sides of the screen are bowed towards left or right.
- Parallelogram : Adjust the parallelogram when the screen is leaning left or right.
- Trapezoid : Adjust the trapezoid of the screen by moving the lines inward or outward.
- Rotation : Adjust the rotation when the screen is tilted left or right.
- Top Corner Correction : Adjust the Top corner
- Bottom Corner Correction : Adjust the Bottom corner



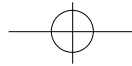

Color

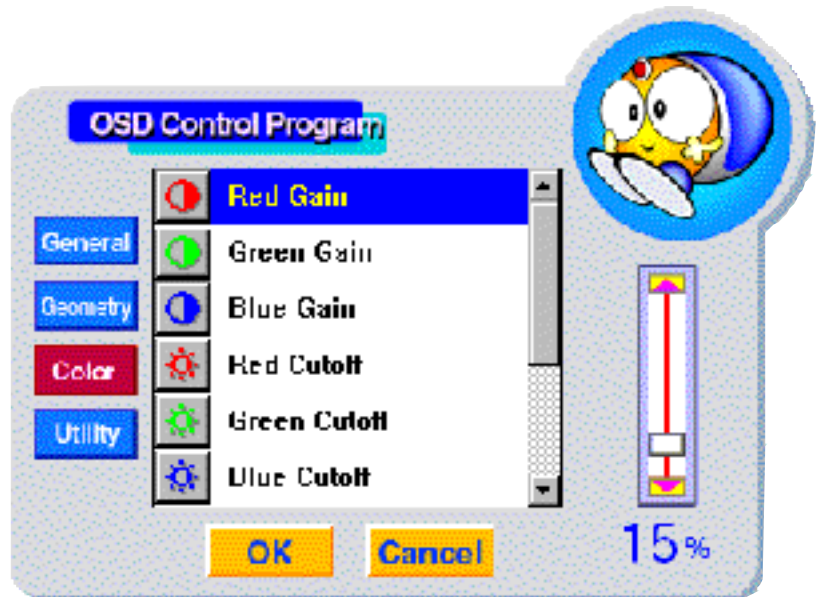

[figure. 22]

- Red Gain : Adjust the red gain.
- Green Gain : Adjust the green gain.
- Blue Gain : Adjust the blue gain.
- Red Cutoff : Adjust the red cutoff.
- Green Cutoff : Adjust the green cutoff.
- Blue Cutoff : Adjust the blue cutoff.
- 9300K Recall
- 6500K Recall
- User color recall : Return the color value (set by user)
- User color save : Save the color value (set by user)



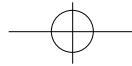

Utility

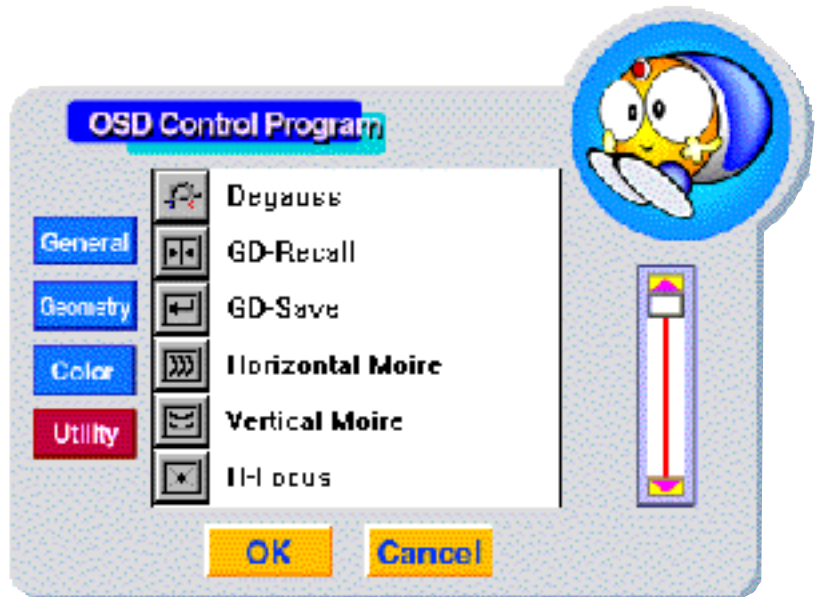

[figure. 23]

- Degauss : Degauss the display and restore image quality.
- GD-Recall : Return the original value
- GD-Save : Save the setting value
- Horizontal Moire : Adjust the horizontal picture moire cancellation.
- Vertical Moire : Adjust the vertical picture moire cancellation.
- H-Focus : Adjust the focus image.



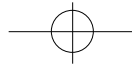



Ch.5 Mother board

1.Specification

Item	Specifications
Model Name	CB657N-BX
CPU	Single Celeron Processor 400/433/466/500MHz (370-pin PGA connector)
Front Side Bus	66/100MHz
Main Memory	- Supports a maximum memory size of 256MB - Supports two 168-pin DIMM Sockets - Supports PC100/66 SDRAM
VGA Controller	- Built in M/B controller support 1X/2X AGP - Trident Blade 3D, Support Max, 8MB SDRAM - Internal Inter-connection to Monitor
USB	2 USB ports
IDE	- 40-pin Boxed-Header for IDEs (Primary IDE) - 50-pin Boxed-Header(2mm pitch) for CDROM (Secondary IDE)
I/O Controller	- 1 Serial port - 1 Parallel port with ECP and EPP support - Interface for one 1.2MB, 1.44MB, and 2.88MB Diskette Drive - PS/2 type mouse and keyboard interfaces

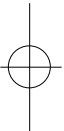

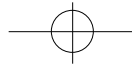

Item	Specifications
Audio	<ul style="list-style-type: none"> - Built in Trident 4DWAVE-DX-1 PCI Audio controller - Crystal 4297A stereo audio CODEC or compatible part - Built in 1.5W Audio Amplifier - Integrated with internal speaker - Audio in/audio out
BIOS	<ul style="list-style-type: none"> - Phoenix PnP BIOS - 2MB Flash ROM
LAN/HPNA Controller (Option)	<ul style="list-style-type: none"> - Built in Intel 21145 10Base-T/HomeRun controller - Support Ethernet 10Base-T and HPNA 1.0 - Support One RJ-45(with active LED) and Two RJ-11
Expansion Slot	One PCI slot for Riser Card
Hardware Monitoring	<ul style="list-style-type: none"> - An integrated ambient temperature sensor - Fan Speed sensors - Power supply voltage monitoring to detect levels above or below acceptable values

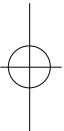

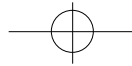

2. Layout

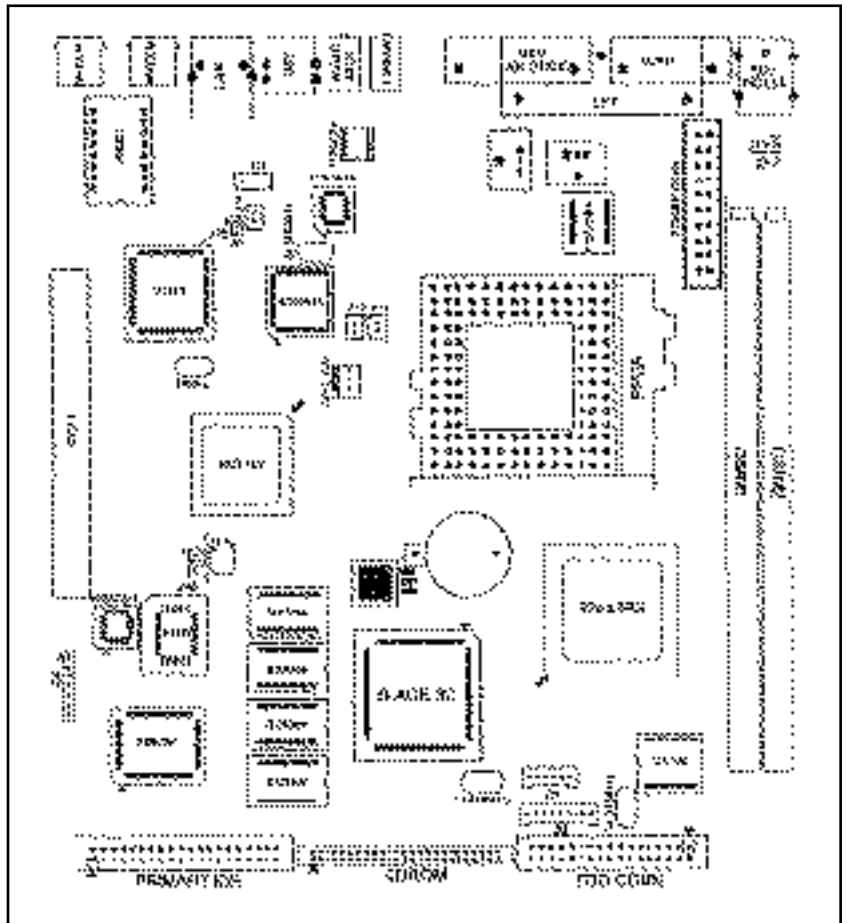

[figure. 24]



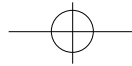

3. Set Jumpers

Pin assignment

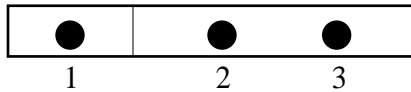

CMOS Clear(JP6)

To clear the CMOS Data :

- 1) Turn off your computer and plugged out your AC power cord from wall socket
- 2) Close pins 2-3, wait five seconds and place the jumper back on pins 1 2(The jumper must be placed back on pins 1-2 for the system t function properly)
- 3) Turn on your computer

Clear CMOS	JP6
Normal	1-2
Clear	2-3

Disable On-board Audio(JP8)

This Jumper uses for Enable or Disable the on board audio subsystem.

Internal Audio	JP8
Enable(Default)	1-2
Disable	2-3

Enable Keyboard password power on function(JP7)

This jumper uses for Enable or Disable Keyboard Password power on function7

K/B Password on	JP8
Enable(Default)	1-2
Disable	2-3



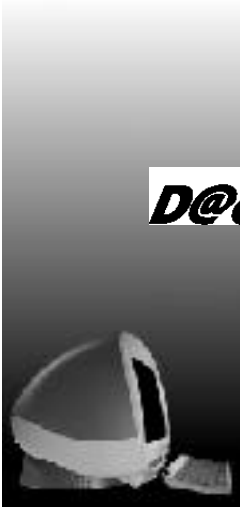
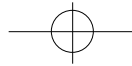

Ch.6 Bios Setup

The SETUP program is a built-in program that allows configuration of functions and devices of the system.

This chapter provides information on how the setup program allows you to configure the function and device of your computer and how to configure each item on the setup menu.

■ Changing/Saving SETUP

1. SETUP can be invoked when the power is turned on or software reset is initiated. During the initial boot sequence, Press <F2> will display the setup main screen.
2. From the initial SETUP menu, use arrow key(Right or Left) to display the next or previous menu.

There are six SETUP menus and they are :

- Main
- Advanced
- Security
- Power
- Boot
- Exit

3. To select an option entry, press arrow key (Up or Down). As the cursor moves through the menu, the current option is highlighted.

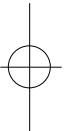

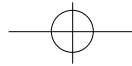

4. <+>,<-> and the space bar will scroll the current field's value.
5. To change a value of configuration, repeat the procedure 2 through 4.
6. If you press<ESC>, the Exit menu will be displayed.
Save your changes to CMOS and exit system Setup.

■ Reconfiguring SETUP with Default Values

1. During boot-up sequence, press<F2> to display the SETUP menu.
2. Press <ESC> to go to the 'Exit' menu.
3. On the "Load Setup Defaults" option, press <Enter> and select <Yes>.
4. Select the "Exit Saving Changes" to save the default values and ex SETUP.

■ Next sections provide explanation of the SETUP configurations.

1. MAIN Setup Menu

To start Phoenix BIOS Setup utility :

1. Turn on or reboot your system. Phoenix BIOS displays this message :

Press <F2> to enter SETUP.

2. Pressing <F2> displays the Main Menu, which looks like this :

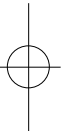

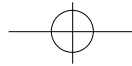

Phoenix BIOS Setup Utility					
Main	Advanced	Security	Power	Boot	Exit
System Time : [12:00:13] System Date : [07/04/1999] Legacy Diskette A : [1.44/1.25 MB 3 1/2"] Legacy Diskette B : [Disabled] ▶ Primary Master [Qudntum XXX] ▶ Primary Slave [None] ▶ Secondary Master [CD-ROM] ▶ Secondary Slave [None] ▶ Keyboard Features System Memory : 640KB Extended Memory : 64512 KB					Item Specific Help <Tab>, <Shift-Tab>, or <Enter> selects field.
F1	Help	↑↓ Select Item	-/+ Change Values	F9 Setup Defaults	
Esc	Exit	←→ Select Menu	Enter Select ▶Sub-Menu	F10 Save and Exit	

<Figure1> Main Screen

Use this menu for basic system configuration.

You can make the following selections on the Main Menu itself.

-System Time

This option displays the current system time.

Use <+> and <-> keys to change the values.

Press <Enter> to move from the Hour to the Minute to the second field.



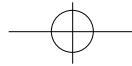

-System Date

This option displays the current system date.
Use <+> and <-> keys to change the values.
Press <Enter> to move from the Month to the Date to the Year field.

-Legacy Diskette A : / Legacy Diskette B :

These options define whether to use the 'A' drive/'B' drive and set the type of floppy disk drive installed in each drive.

-Primary Master/Slave, Secondary Master/Slave

The Master and Slave settings on the Main Menu control the types of devices:

- Hard-disk drives / • Removable-disk drives / • CD-ROM drives

The setting is defined to 'Auto' to automatically select the hard disk parameters and the protocol at the time of boot-up. The user can define its own parameter by selecting the 'User' value.

If you press <Enter>, the screen displaying data for each device will appear.

-Keyboard Features

Specify Keyboard Features as Following :

- Num Lock : On or Off turns NumLock on or off at bootup. Auto turns NumLock on if it finds a numeric key pad.
- Key Click : Turns audible key click on.
- Keyboard auto-repeat rate : Sets the number of times a second to repeat keystroke when you hold the key down.
- Keyboard auto-repeat delay : Set the delay time after the key is held down before it begins to repeat the keystroke.
- Legacy USB Support:Enable/Disable for Legacy Universal Serial Bus.

-System Memory

Displays the amount of conventional system memory detected during bootup.

-Extended Memory

Displays the amount of extended system memory detected during bootup.

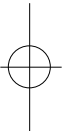

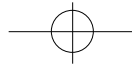

2. Advanced Setup Menu

Use this menu to set the Advanced Features available on your system chipset.

Selecting “Advanced” from the Menu Bar displays the Advanced Menu which looks like this :

PhoenixBIOS Setup Utility					
Main	Advanced	Security	Power	Boot	Exit
<p style="text-align: center;">Setup Warning</p> <p>Setting items on this menu to incorrect values may cause your system to malfunction.</p> <p>Installed O/S : [Win 98 / Win 2000] Reset Configuration Data : [No]</p> <p>PS/2 Mouse [Auto Detect] Large Disk Access Mode : [DOS] Local Bus IDE adapter : [Both] Spread Spectrum [Disabled]</p> <p>► I/O Device Configuration</p>					<p style="text-align: center;">Item Specific Help</p> <p>Select the operating system installed on your system which you will use most commonly.</p> <p>Note : An incorrect setting can cause some operating systems to display unexpected behavior.</p>
F1	Help	↑↓	Select Item	-/+	Change Values
F9	Setup Defaults				
Esc	Exit	←→	Select Menu	Enter	Select ►Sub-Menu
F10	Save and Exit				

<Figure 2> Advanced Screen



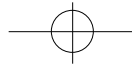

-Installed O/S

Select the operating system installed on your system which you will use most commonly.

(Note : An incorrect setting can cause some operating systems to display unexpected behavior.)

-Reset Configuration Data

To reset PnP data, set the value to 'Yes'. 'Yes' erases all configuration data in ESCD, which stores the configuration settings for non-PnP plug-in devices.

Select 'Yes' when required to restore the manufacturer's defaults.

-PS/2 Mouse

This is to 'Enable' or to 'Disable' PS/2 Mouse functions.

'Auto Detect' will enable the PS/2 mouse only if present.

-Large Disk Access Mode

Select 'DOS' if you have DOS.

Select 'Other' if you have another operating system such as UNIX.

A large disk is one that has more than 1024 cylinders, more than 16 heads or more than 63 tracks per sector.

-Local Bus IDE adapter

Enable the integrated local bus IDE adapter.

Specifies an option from below.

- Disabled : Disable the Local Bus IDE adapter.
- Primary : Use only the primary Local Bus IDE.
- Secondary : Use only the Secondary Local Bus IDE.
- Both : Use both Local Bus IDE adapters.



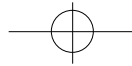

-Spread Spectrum

When this item is Enabled, the EMI noise can be extremely minimized.

-I/O Device Configuration.

This item allows you to configure I/O device as following.

- Serial port A/ Serial port B : Assign a port address to each serial port.
- Parallel Port : Assign a port address to the parallel port.
- Floppy disk Controller : Enable/Disable the Floppy disk controller.

3. Security Setup Menu

Use this menu to set User and Supervisor Password and Backup and Virtual check reminder.

Selecting “Security” from the Menu Bar displays the Security menu, which looks like this :



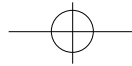

PhoenixBIOS Setup Utility					
Main	Advanced	Security	Power	Boot	Exit
					Item Specific Help
Supervisor Password Is :		Clear	Supervisor Password controls access to the setup utility.		
User Password Is :		Clear			
Set Supervisor Password		[Enter]			
Set User Password		[Enter]			
Password on boot :		[Disabled]			
Diskette access :		[Supervisor]			
Fixed disk boot sector :		[Normal]			
▶ Power Supply Control					
F1	Help	↑↓ Select Item	-/+ Change Values	F9 Setup Default	
Esc	Exit	←→ Select Menu	Enter Select ▶Sub-Menu	F10 Save and E	

<Figure 3> Security Screen

-Supervisor Password Is : /User Password Is :

These items show the states of the Supervisor and User Password.

-Set Supervisor Password

Set a Supervisor Password.

To clear the current password, just hit <Enter> on New Password and confirm Password.



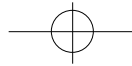

-Set User Password

Can set a User Password only when a supervisor password is set up.

To clear the current password, just hit <Enter> on New Password and confirm

Password.(Maximum five characters can be used for a password.)

-Password on boot

If 'Enabled', entry of the password is required to boot up system.

-Diskette access

This item allow you to control access to diskette drives.

If supervisor password is 'Enabled', access to the FDD is limited to the supervisor.

-Fixed disk boot sector

If 'Write protect' is set for this option, the boot sector of the hard disk is write-protected to against viruses.

(This must be set to 'Normal' to transmit system files of the hard disk or to format the hard disk.)

-Power Supply Control

This item allows you to select a method to power on by keyboard.

(Note : USB keyboards can not be used to power on.)

Disable : Disable the keyboard power on.

PC 98-KBD : It allows you to power on the system by the PC98 keyboard's Power Button.

Hot-Key:It allows you to power on the system by the Hot-key.

(Ctrl + F1/Ctrl + F2/Ctrl + F3/Ctrl + F4)

Password : It allows you to power on the system by the password that you entered.



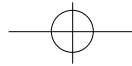

4. Power Setup Menu

Use this menu to configure Power-Management features. Selecting “Power” from the Menu Bar displays the Power menu which looks like this :

PhoenixBIOS Setup Utility					
Main	Advanced	Security	Power	Boot	Exit
					Item Specific Help
PowerButton Override :		[Enabled]			<Enabled>
Power Savings :		[Disabled]			: Use PowerButton as the Suspend/Resume Button and support 4sec Power Override.
Idle Mode :		[Off]			<Disabled>
Standby Timeout :		[Off]			:Use PowerButton as the Soft Off Button.
Auto Suspend Timeout:		[Off]			
Suspend Mode :		[Suspend]			
Resume On Time :		[Off]			
Resume Time :		[00 : 00 : 00]			
Resume On Modem Ring :		[Off]			
F1 Help	↑↓ Select Item	-/+ Change Values	F9 Setup Defaults		
Esc Exit	←→ Select Menu	Enter Select▶ Sub-Menu	F10 Save and Exit		

<Figure 4> Power Screen



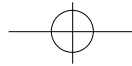

-Power Buton Override

Specify power button option as following:

Enabled : Use Power Button as the Suspend/Resume Button and support sec Power override.

Disaled : Use Power Button as Softoff Button.

- Power Savings

Specify Power Savings option as following :

Disabled : Turn off Power Management.

Customized : Can define the “Standby Timeout” and “Auto Suspend Timeout”.

- Idle Mode

Slows the CPU clock down when the system is inactive for a pre-define period of time.

It is restored when the system is used again.

- Standby Timeout

Define the “Standby Timeout”.

- Auto Suspend Timeout

Define the “Auto Suspend Timeout”.

- Suspend Mode

Suspend(When the Suspend Mode is set to “Suspend”)

Save system data in DRAM and control system power by shutting down power supply to peripheral devices.

:Entering into the Suspend Mode

- On the ‘Shutdown’ command by Windows.
- By pressing the Power switch.

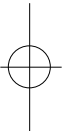

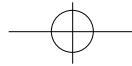

: Resuming from the Suspend Mode

- By Pressing the Power switch, Keyboard, Mouse
- When the modem rings(when "Resume On Modem" is set to "On")
- Accoring to the time set in the timer(When "Resume On Time" is set to "On")

Save To Disk(When the Suspend Mode is set to "Save To Disk")
Save system date into the hard disk and turn the system power off for maximum power saving.

:Entering into the Save To Disk Mode

- On the 'Shutdown' command by Windows.
- By pressing the Power switch.
- According to the time set in the timer(According to the value in "Suspend" Windows)

:Resuming from the Save To Disk Mode

- By Pressing the Power switch
- By Password when it was used at "Power Supply Control"

* On Windows98/NT/Win2000, It is recommended that you follow the normal closing procedure for the protection of the system.

* Power Saving mode is not supported in the OS environment where power management is not provided. Therefore, the "Save To Disk" mode is not supported when the system is booted either with DOS or Windows NT4.0.

-Resume On Time

According to the pre-set, the system recovers from the Suspend mode. Enabled wakes the system up at a specific time.

-Resume Time

Define the 'Resume Time' when 'Resume On Time' is set to 'On'.

-Resume On Modem Ring

Enabled wakes the system up when an incoming call is detected on your modem.

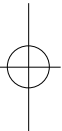

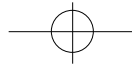

5. Boot Setup Menu

Use this menu to specify any drive as a boot drive.

Selecting “Boot” from the Menu Bar displays the Boot menu, which looks like this :

PhoenixBIOS Setup Utility					
Main	Advanced	Security	Power	Boot	Exit
					Item specific Help
1.		[Removable Devices]			Use <↑> or <↓> to select a device, then press <+> to move it up the list, or <-> to move it down the list. Press <Esc> to exit this menu.
2.		[Hard Drive]			
3.		[ATAPI CD-ROM Drive]			
4.		[Network Boot]			
	▶	Hard Drive			
	▶	Removable Devices			
	QuickBoot Mode:	[Enabled]			
	Summary screen:	[Enabled]			
F1	Help	↑↓ Select Item	-/+ Change Values		F9 Setup Defaults
Esc	Exit	←→ Select Menu	Enter Select▶ Sub-Menu		F10 Save and Ex

<Figure 5> Boot Screen



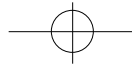

-1/2/3/4

You can arrange the Boot Order List at the top of this menu to specify the order of the devices from which the BIOS will attempt to boot the Operating System. To move a device, first select it with up-or-down arrow keys, and move it up or down using the <+> and <-> keys.

Note : If you have more than one hard drive, or more than one removable devices, use the sub menus to specify which one to use on the boot order list, as described in the following.

-Hard Drive

If you have more than one hard drive, selecting “Hard Drive” from the Boot Menu. Select the hard to use for booting by using the up-and-down arrows.

Then move it to the top of this list using the<+> key.

-Removable Devices

If you have more than one removable device, selecting “Removable Devices” from the Boot Menu. Select the removable device to use for booting by using the up-and-down arrows.

Then move it to the top of this list using the<+> key.

-QuickBoot Mode

By skipping a few tests for booting, Quick Boot mode reduces system booting time.

-Summary screen

Display system configuration on boot.

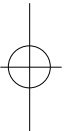

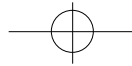

6. Exit Setup Menu

Exits the current menu.

Selecting “Exit” from the Menu Bar displays the Exit menu, which look like this :

PhoenixBIOS Setup Utility							
Main	Advanced	Security	Power	Boot	Exit		
Exit Saving Changes Exit Discarding Changes Load Setup Defaults Discard Changes Save Changes					Item specific Help Exit System Setup and save your changes to CMOS.		
F1	Help	↑↓	Select Item	-/+	Change Values	F9	Setup Defaults
Esc	Exit	←→	Select Menu	Enter	Execute Command	F10	Save and Ex

<Fihure 6> Exit Screen



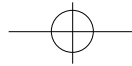

-Exit Saving Changes

Save current values and exit the SETUP program.

-Exit Discarding Changes

Ignore the changes and exit SETUP program.

-Load Setup Defaults

Assign default values to configuration fields.

-Discard Changes

Ignore the changes.

-Save Changes

Save current values to CMOS.

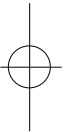

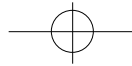

* Other System Related Issues

“Phdisk32” Utility(Phdisk32.exe)

This utility creates a hidden file(save2disk.bin) on the HDD to store data saved for the ‘Save To Disk’ mode. The initial file size is approximately 170MB (the maximum system memory is 160MB) and the size can be changed by the user. This utility file is located in the ‘System’ folder of the ‘EASY COMPUTER GUIDE’ CD. Run ‘Phdisk32.exe’ to view instruction.

If you formatted the hard disk or replaced it with a new one purchased elsewhere, you must create the ‘save2disk.bin’ file to enable ‘Save to Disk’ function by running ‘Phdisk32.exe’ (‘Phdiskf.exe’ if partition of the hard disk is FAT16).

Ex) C:\>phdisk32/create 107520(file size for 96MB system memory)

Computing the size of the ‘save2disk.bin’ file for phdisk32.

Ex) If the system memory is 96MB and the video memory is 4MB

- Hard Disk Space Required = System Memory (96MB) + Video Memory(4MB)

+ Space required for system configuration (5MB)

= 105MB

= 105 X 1024(1MB = 1024MB)

= 107520KB

- Therefore, you should type ‘phdisk32 / create 107520’ at ‘C:\>’ and press <Enter>.

