Copyright and Warranty Notice

The information in this document is subject to change without notice and does not represent a commitment on part of the vendor, who assumes no liability or responsibility for any errors that may appear in this manual.

No warranty or representation, either expressed or implied, is made with respect to the quality, accuracy or fitness for any particular part of this document. In no event shall the manufacturer be liable for direct, indirect, special, incidental or consequential damages arising from any defect or error in this manual or product.

Product names appearing in this manual are for identification purpose only and trademarks and product names or brand names appearing in this document are property of their respective owners.

This document contains materials protected under International Copyright Laws. All rights reserved. No part of this manual may be reproduced, transmitted or transcribed without the expressed written permission of the manufacturer and authors of this manual.

If you do not properly set the motherboard settings causing the motherboard to malfunction or fail, we cannot guarantee any responsibility.



ZH6 Motherboard User's Manual

Table of Contents

CHAPTER 1. INTRODUCTION OF ZH6 FEATURES	1
1-1. FEATURES OF THIS MOTHERBOARD	1
1-2. SPECIFICATIONS	2
1-3. LAYOUT DIAGRAM	4
1-4. THE SYSTEM BLOCK DIAGRAM	5
CHAPTER 2. INSTALLING THE MOTHERBOARD	1
2-1. INSTALLING THE MOTHERBOARD TO THE CHASSIS	2
2-2. INSTALLATION OF THE PENTIUM® II/III, CELERON® CPU	3
2-3. INSTALLING SYSTEM MEMORY	3
2-4. CONNECTORS, HEADERS AND SWITCHES	6
CHAPTER 3. INTRODUCTION OF THE BIOS	1
3-1. CPU SETUP [SOFT MENU™ II]	3
3-2. STANDARD CMOS SETUP MENU	8
3-3. BIOS FEATURES SETUP MENU	11
3-4. CHIPSET FEATURES SETUP MENU	16
3-5. POWER MANAGEMENT SETUP MENU	20
3-6. PNP/PCI CONFIGURATION	24
3-7. LOAD SETUP DEFAULTS	24
3-8. INTEGRATED PERIPHERALS	24
3-9. PASSWORD SETTING	24
3-10. IDE HARD DISK DETECTION	24
3-11. SAVE & EXIT SETUP	24
3-12. EXIT WITHOUT SAVING	24
APPENDIX A BIOS FLASHING USER INSTRUCTIONS	
APPENDIX B INSTALLING THE HIGHPOINT XSTORE PRO UTILITY	
APPENDIX C HARDWARE MONITORING FUNCTION (INSTALLING THE WINBOND HARDWARE DOCTOR UTILITY)	
APPENDIX D TROUBLESHOOTING (NEED ASSISTANCE?)	

Chapter 1. Introduction of ZH6 Features

1-1.Features of This Motherboard

The motherboard is designed for a new generation CPUs. It supports the Intel SLOT1 structure (Pentium® II/III and Celeron® processors), up to 512MB of memory, super I/O, and Green PC functions.

The ZH6 has built-in hardware monitoring functions (you can refer to *Appendix C* for detailed information), they can monitor and protect your computer insuring a safe computing environment. The ZH6 also supports both the PS/2 keyboard and PS/2 mouse wake up features (you can refer to section 3-8 for detailed information), letting you easily wake up your system by these devices. The motherboard can provide high performance for workstations and meets the requirements for desktop systems for multimedia in the future.

Sets You Free From the Y2K Threat

The potential threat of Year 2000 (Y2K) problems are making everyone very nervous. The Y2K issue applies to almost any device, firmware, or software that operates on or with year based dates. This problem is caused by a design flaw in the **Real Time Clock (RTC)** unit. The RTC only changes the last two digits of the year code, but not the century information. As a result, when it comes to 12:00 AM January 1, 2000 the RTC will switch from December 31 11:59 PM 1999 to 12:00 AM January 1 1900.

Y2K compliance deals with the date change over from 31 December 1999 to 1 January 2000, and with recording and reporting of all dates from the RTC including leap year dates. This motherboard is free from the Y2K problem because its BIOS are Y2K compliant.

Please Note

If the operating system or application software cannot handle Year 2000 dates, you will still be facing the Y2K threat because it is not a hardware problem that relates to the motherboard itself. According to Award BIOS, it is BIOS source code released after 31 May 1995 complies with all known Y2K issues; however, it may still fail the 2000.exe test. Award has modified its BIOS source code to accommodate the requirements of 2000.exe. Award BIOS source code issued later than 18 November 1996 passes the NTSL 2000.exe test program.

1-2. Specifications

1. CPU

- Supports Intel® Pentium® III 450 ~ 550 MHz Processor cartridge.
- Supports Intel® Pentium® II 233 ~ 450 MHz Processor cartridge.
- Supports Intel® Celeron™ 266 ~ 433MHz processors (Cartridge)
- Supports Intel® Celeron™ 300A MHz~466MHz processors (Based on 66MHz PPGA processor with adapter)
- Supports 66 and 100MHz CPU external clock speeds

2. Chipset

- Intel® 440ZX chipset (82443ZX and 82371EB)
- Supports Advanced Configuration and Power Management Interface (ACPI)
- Accelerated Graphics Port connector supports AGP 1x and 2x mode (Sideband) 3.3V device

3. Memory (System Memory)

- Three 168-pin DIMM sockets support SDRAM modules
- Supports up to 512MB MAX. (8, 16, 32, 64, 128, 256 MB SDRAM)

4. System BIOS

- CPU SOFT MENU™ II, can easily set the processor parameters
- AWARD BIOS
- Supports Plug-and-Play (PnP)
- Supports Advanced Configuration Power Interface (ACPI)
- Supports Desktop Management Interface (DMI)
- Year 2000 compliant

5. Multi I/O Functions

- 2x Channels of Bus Master IDE Ports supporting up to four Ultra DMA 33 devices
- PS/2 Keyboard and PS/2 Mouse Connectors
- 1x Floppy Port (up to 2.88MB)
- 1x Parallel Port (EPP/ECP)
- 2x Serial Ports
- 2x USB Connectors

6. Miscellaneous

- ATX form factor
 - One AGP slot, five PCI slots and two ISA slots
 - Supports PS/2 keyboard and PS/2 mouse wake-up functions
 - Built-in Wake on LAN header
 - Built-in IrDA TX/RX header
 - Built-in SB-Link™ header
 - Built-in Wake On Ring header
 - Built-in SMBus header
 - Hardware monitoring : Included fan speed, voltages, CPU and system environment temperature
 - Board size: 305 * 190mm
- * **The 82443ZX chip can support 4 bus master control signals, PCI slots 4 and 5 use the same bus master control signal.**
- * **Supports Wake On LAN, Keyboard or Mouse, but your ATX power supply 5V standby power must be able to provide at least a 720mA current capacity. Otherwise, the functions may not work normally.**
- * **There are three Memory module sockets on the system board, but total four banks.**
- * Above 66MHz/100MHz bus speeds are supported but not guaranteed due to the PCI and chipset specifications.
- * Sound Blaster™ is a registered trademark of Creative Technology Ltd. in the United States and certain other countries. Sound Blaster - LINK™ and SB-LINK™ are trademarks of Creative Technology Ltd.
- * Specifications and information contained in this manual are subject to change without notice.

Note

All brand names and trademarks are the property of their respective owners.

1-3. Layout Diagram

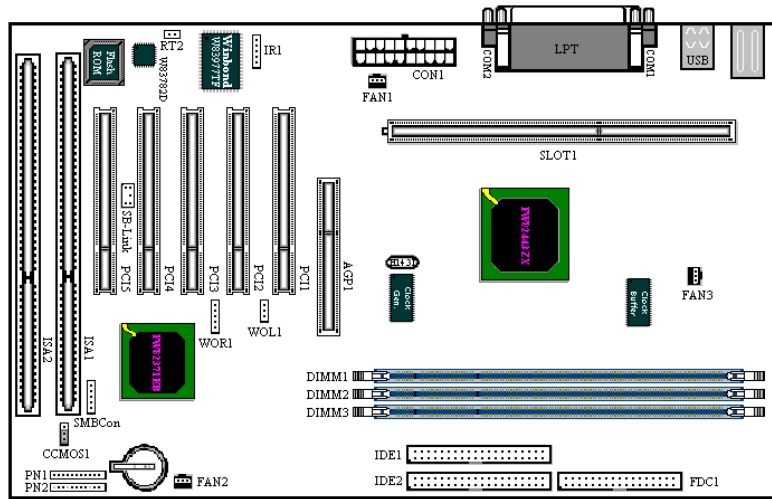

AB-ZH6

Figure 1-2. Motherboard component location

1-4. The System Block Diagram

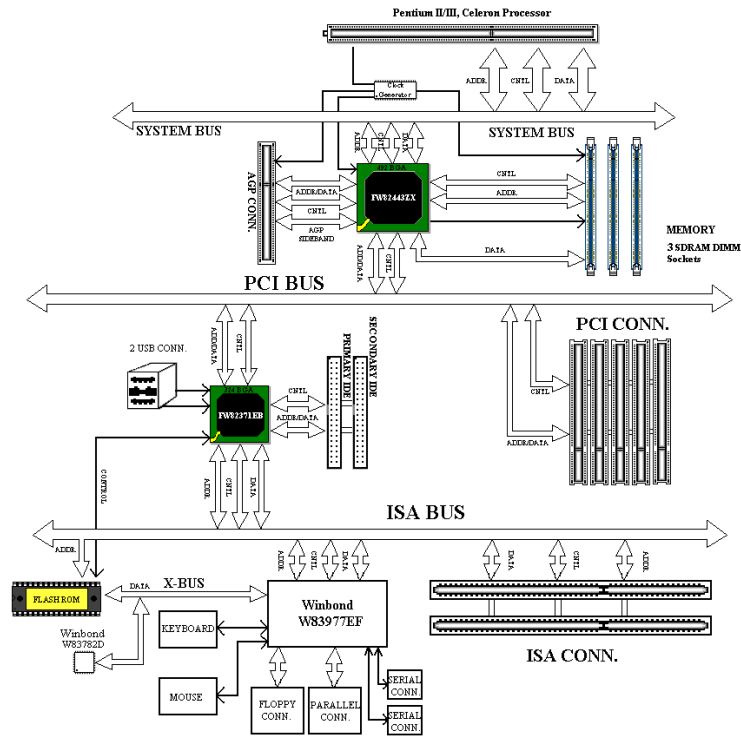

Figure 1-3. System diagram of the 440ZX chipset

Chapter 2. Installing the Motherboard

This ZH6 motherboard not only provides all standard equipment for classic personal computers, but also provides great flexibility for meeting future upgrade demands. This chapter will introduce step by step all the standard equipment and will also present, as completely as possible, future upgrade capabilities. This motherboard is able to support all Intel® Pentium® II/III processors and Intel® Celeron® processor now on the market. (For details, see specifications in Chapter 1.)

This chapter is organized according the following features:

- 2-1 Installing the Motherboard to the Chassis
- 2-2 Installation of the Pentium® II/III, Celeron® CPU
- 2-3 Installing System Memory
- 2-4 Connectors, Headers and Switches



Before Proceeding with the Installation



Before you install or unplug any connectors or add-on cards, please remember to turn the ATX power supply switch off (fully turn the +5V standby power off), or take the power cord off. Otherwise, you may cause the motherboard components or add-on cards to malfunction or be damaged.



User Friendly Instructions

Our objective is to enable the novice computer user to perform the installation by himself. We have attempted to write this document in a very clear, concise and descriptive manner to help overcome any obstacles you may face during installation. Please read our instructions carefully and follow them step-by-step.

2-1. Installing the Motherboard to the Chassis

Most computer chassis will have a base on which there will be many mounting holes that allows the motherboard to be securely attached and at the same time, prevents short circuits. There are two ways to attach the motherboard to the base of chassis:

- with studs
- or with spacers

Please refer to the figure 2-1 that shows the studs and spacers, they may have several types, but all look like the figures below:

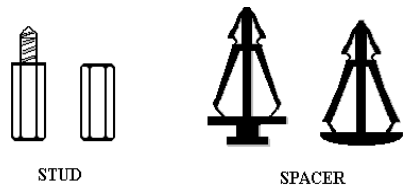

Figure 2-1. The outline of stub and spacer

In principle, the best way to attach the motherboard is with studs, and only if you are unable to do this should you attach the board with spacers. Take a careful look at the motherboard and you will see many mounting holes on it. Line these holes up with the mounting holes on the base. If the holes line up, and there are screw holes this means you can attach the motherboard with studs. If the holes line up and there are only slots, this means you can only attach the motherboard with spacers. Take the tip of the spacers and insert them into the slots. After doing this to all the slots, you can slide the motherboard into position aligned with the slots. After the motherboard has been positioned, check to make sure everything is OK before putting the casing back on.

Figure 2-2 shows you the way to affix the motherboard using studs or spacers:

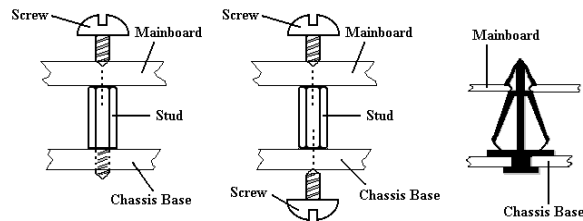

Figure 2-2. The way we fixed the motherboard

Note

If the motherboard has mounting holes, but they don't line up with the holes on the base and there are no slots to attach the spacers, don't worry, you can still attach the spacers to the mounting holes. Just cut the bottom portion of spacers (the spacer may be a little hard to cut off, so be careful of your hands). In this way you can still attach the motherboard to the base without worrying about short circuits. Sometimes you may need to use the plastic springs to isolate the screw from the motherboard PCB surface, because the circuit wire may be near by the hole. Be careful, don't let the screw contact any printed circuit wire or parts on the PCB that are near the fixing hole, otherwise it may damage the board or cause board malfunctioning.

2-2. Installation of the Pentium® II/III, Celeron® CPU

The installation method for the CPU is printed on the package of the retention mechanism that comes with the motherboard. You can refer to it while you install the CPU. This motherboard also supports the Celeron® PPGA processor. If you want to install the Celeron® PPGA processor, you have to use an additional adapter that allows you to use a Celeron® PPGA processor in a slot 1 board. For this ABIT makes the SlotKET® adapter.

Note:

- Installing a heat sink and cooling fan is necessary for proper heat dissipation from your CPU. Failing to install these items may result in overheating and damage of your CPU.
- Please refer to your boxed processor installation or other documentation attached with your CPU for detailed installing instructions.

2-3. Installing System Memory

This motherboard provides three 168-pin DIMM sites for memory expansion. The DIMM sockets support 1Mx64 (8MB), 2Mx64 (16MB), 4Mx64 (32MB), 8Mx64 (64MB), 16Mx64 (128MB), and 32Mx64 (256MB) or double sided DIMM modules. Minimum memory size is 8MB and maximum memory size is 512MB SDRAM. There are three Memory module sockets on the system board. (Total four banks)

In order to create a memory array, certain rules must be followed. The following set of rules allows for optimum configurations.

- The memory array is 64 or 72 bits wide. (depending on with or without parity)
- Those modules can be populated in any order.
- Supports single and double density DIMMS.

Table 2-1. Valid Memory Configurations

Bank	Memory Module	Total Memory
Bank 0, 1 (DIMM1)	8MB, 16MB, 32MB, 64MB, 128MB, 256MB	8MB ~ 256MB
Bank 2, 3 (DIMM2)	8MB, 16MB, 32MB, 64MB, 128MB, 256MB	8MB ~ 256MB
Bank 2, 3 (DIMM3)	8MB, 16MB, 32MB, 64MB, 128MB, 256MB	8MB ~ 256MB
Total System Memory		8MB ~ 512MB

Note 1. When you install RAM modules, we strongly suggest that you install them in the order of filling DIMM 1~ DIMM3. If you install RAM modules disregarded this order, you may encounter some problems. One of problems might be that you can't boot up the system. Another possible problem is that the BIOS won't be able to detect the memory you installed.

Note 2. According to this motherboard layout design, DIMM 2 and DIMM 3 share two banks. Therefore, please don't install RAM modules that will occupy two banks into both DIMM 2 and DIMM 3 at the same time. There are two main types of RAM modules on the market now, one is single sided and the other is double sided. The single sided RAM module doesn't mean it only occupies one bank, and double sided RAM module also doesn't mean it will occupy two banks. When you want to install RAM modules into both DIMM 2 and DIMM 3 at the same time, please make sure how many banks of RAM the modules will occupy. For this issue, you can refer to the specifications of your RAM module from the manufacturer.

Generally, installing SDRAM modules to your motherboard is an easy thing to do. You can refer to figure 2-3 to see what a 168-pin PC100 SDRAM module looks like.

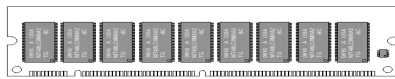

Figure 2-3 PC100 Module and Component Mark

Unlike installing SIMMs, DIMMs may be "snapped" directly into the socket.

Note: Certain DIMM sockets have minor physical differences. If your module

doesn't seem to fit, please do not force it into the socket as you may damaged your memory module or DIMM socket.

The following procedure will show you how to install a DIMM module into a DIMM socket.

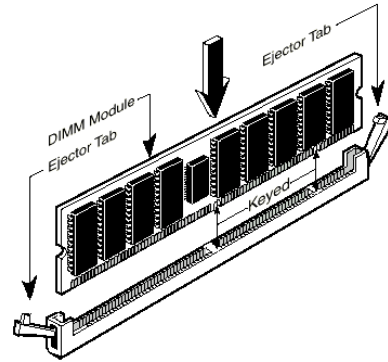

Figure 2-4. Memory module installation

memory expansion DIMM socket.

- Step 1.** Before you install the memory module, please place the computer power switch in the *off* position and disconnect the AC power cord from your computer.
- Step 2.** Remove the computer's chassis cover.
- Step 3.** Before touching any electronic components, make sure you first touch an unpainted, grounded metal object to discharge any static electricity stored on your clothing or body.
- Step 4.** Locate your computer's 168-pin
- Step 5.** Insert the DIMM module into the expansion socket as shown in the illustration. Note how the module is keyed to the socket. You can refer to figure 2-4 for the details. *This insures the DIMM module will be plugged into the socket in one way only.* Firmly press the DIMM module into the DIMM socket, making certain the module is completely seated in the DIMM socket.
- Step 6.** Once the DIMM module has been installed, the installation is complete and the computer's cover can be replaced. Or you can continue to install other devices and add-on cards that are mentioned in the following section.

Note

When you install a DIMM module fully into the DIMM socket, the eject tab should be locked into the DIMM module very firmly and fit into its indentation on the both sides.

2-4. Connectors, Headers and Switches

Inside the case of any computer several cables and plugs have to be connected. These cables and plugs are usually connected one-by-one to connectors located on the motherboard. You need to carefully pay attention to any connection orientation the cables may have and, if any, notice the position of the first pin of the connector. In the explanations that follow, we will describe the significance of the first pin.

We will show you all connectors, headers and switches here, and tell you how to connect them. Please pay attention and read the whole section for necessary information before attempting to finish all of the hardware installation inside the computer chassis.

Figure 2-5 shows you all of the connectors and headers that we'll discuss in the next section, you can use this diagram to visually locate each connector and header we describe.

All connectors, headers and switches mentioned here, will depend on your system configuration. Some features you may (or may not) have and need to connect or configure depending on the peripheral. If your system doesn't have such add-on cards or switches you can ignore some special feature connectors.

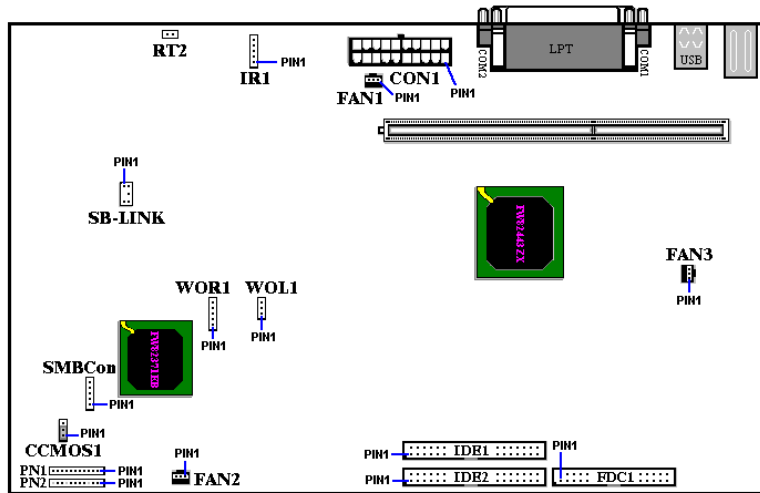
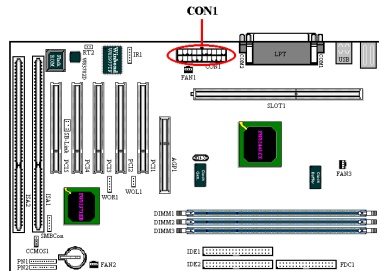

Figure 2-5. All Connectors and Headers for the ZH6

First, Let's see the headers that ZH6 uses, and what their functions are.

CON1: ATX Power Input Connector**Caution**

If the power supply connectors are not properly attached to the CON1 power supply, the power supply or add-on cards may be damaged.



Attach the connector from the power supply to the CON1 connector here. Remember you have to push the connector from the ATX power supply firmly to the end with the CON1 connector, insuring that you have a good connection.

Note: Watch the pin position and the orientation

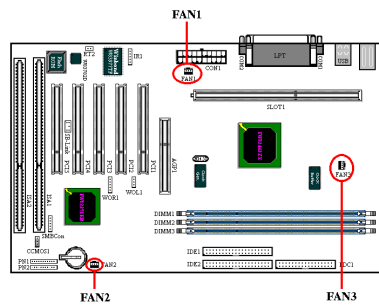
FAN1, FAN2 & FAN3: FAN header

Attach the connector from the individual CPU fan to the header named FAN1, and attach the connector from the chassis fan to FAN2 or & FAN3 header.

You must attach the CPU fan to the processor, or your processor will work abnormally or may be damaged by overheating. Also, if you want the computer case's internal temperature to be kept steady and not too high, you had better connect the chassis fan to reach this goal.

Note: Watch the pin position and the orientation

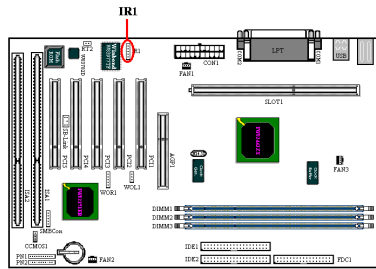
IR1: IR Header (Infrared)

There is a specific orientation for pins 1 through 5, attach the connector from the IR KIT or IR device to the IR1 header. This motherboard supports standard IR transfer rates.

Note: Watch the pin position and the orientation

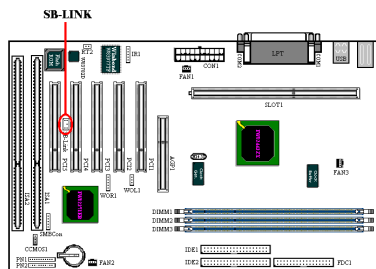
SB-Link: SB-Link™ Header

If your PCI audio adapter supports this feature, then you can connect the specific cable from the audio adapter to this header. SB-LINK™ combines Intel's PC-PCI and "Serialized IRQ" protocols. These technologies can be found in Intel's TX, LX, BX and newer core logic chipsets. This technology provides the DMA and IRQ signals present in ISA Bus today, but not available on the PCI Bus. The SB-LINK™ serves as a bridge between the motherboard and PCI sound card to deliver Sound card for real-mode DOS games. Check to see if your card supports this.

Note: Watch the pin position and the orientation

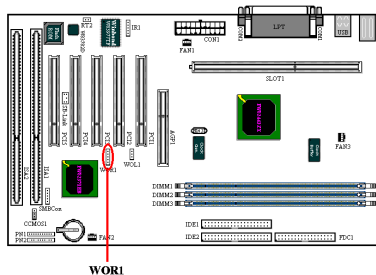
WOR1: Wake On Ring Header

If you have an internal modem adapter that supports this feature, then you can connect the specific cable from the internal modem adapter to this header. This feature lets you wake up your computer via remote control through the modem.

Note: Watch the pin position and the orientation

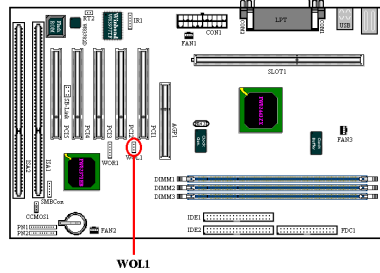
WOL1: Wake on LAN Header

If you have a Network adapter that supports this feature, then you can connect the specific cable from the network adapter to this header. This feature lets you wake up your computer via remote control through a local area network. You may need a specific utility to control the wake up event, like using the Intel® LDCM® utility or other similar utilities.

Note: Watch the pin position and the orientation

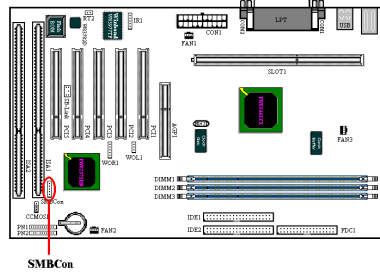
SMBCon: System Management Bus Connector

This connector is reserved for system management bus (SMBus). The SMBus is a specific implementation of an I²C bus. I²C is a multi-master bus, which means that multiple chips can be connected to the same bus and each one can act as a master by initiating a data transfer. If more than one master simultaneously tries to control the bus, an arbitration procedure decides which

master gets priority.

Note: Watch the pin position and the orientation

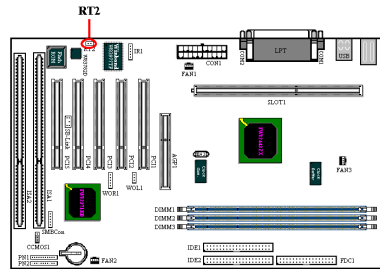
RT2 header:

This header is for you to connect an additional thermistor to detect the CPU temperature. You can buy the thermistor at an electronics store, and ask for a 10KΩ thermistor which will be OK. Please don't use too long of a lead wire for the thermistor. You can see the detected temperature in the BIOS menu. (see Chipset Features Setup Menu)

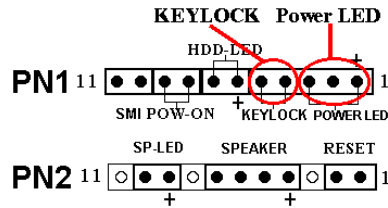
PN1 (Pin 1-2-3-4-5): Power LED and Keylock Switch Headers

There is a specific orientation for pins 1 through 3. Insert the three-threaded power LED cable to pins 1~3, and the two-threaded keylock cable into pin 4 and pin 5. Check to make sure the correct pins go to the correct connectors on the motherboard. If you install them with the wrong direction, the

power LED light will not illuminate correctly.

Note: Watch the power LED pin position and orientation.

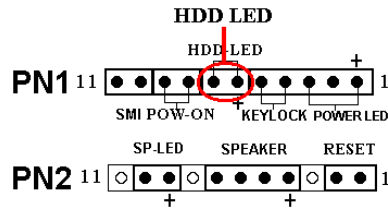
PN1 (Pin 6-7): HDD LED Header

Attach the cable from the case's front panel HDD LED to this header. If you install it in the wrong direction, the LED light will not illuminate correctly.

Note: Watch the HDD LED pin position and the orientation.

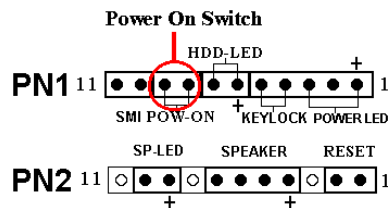
PN1 (Pin 8-9): Power on Switch Header

Attach the cable from the case's front panel power switch to this header.

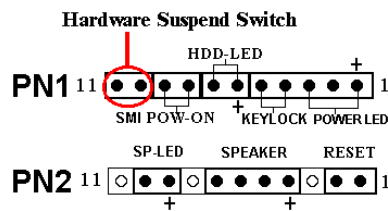
PN1 (Pin 10-11): Hardware Suspend Switch (SMI Switch) Header

Attach the cable from the case's front panel suspend switch (if there is one) to this header. Use this switch to enable/disable the power management function by hardware.

NOTE

If you enable the ACPI function in the BIOS setup, this function will not work.

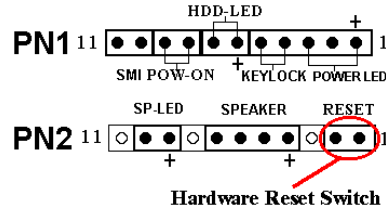
PN2 (Pin 1-2): Hardware Reset Switch Header

Attach the cable from the case's front panel Reset switch to this header. Press and hold the reset button for at least one second to reset the system.

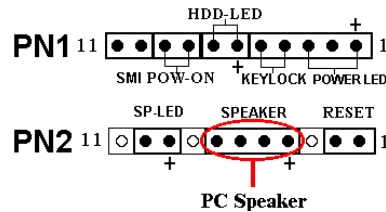
PN2 (Pin 4-5-6-7): Speaker Header

Attach the cable from the system speaker to this header.

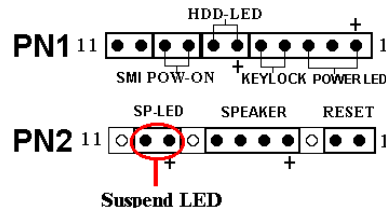
PN2 (Pin 9-10): Suspend LED Header

Insert the two-threaded suspend LED cable into pin 9 and pin 10. If you install it in the wrong direction, the LED light will not illuminate correctly.

Note: Watch the HDD LED pin position and the orientation.

For the PN1 and PN2 pin's count-name list, please refer to table 2-2.

Table 2-2. PN1 and PN2 pin count name list

PIN Name	Significance of signal	PIN Name	Significance of signal		
PN1	PIN 1	+5VDC	PN2	PIN 1	Ground
	PIN 2	No connection		PIN 2	Reset input
	PIN 3	Ground		PIN 3	No connection
	PIN 4	Keyboard inhibit Signal		PIN 4	+5VDC
	PIN 5	Ground		PIN 5	Ground
	PIN 6	LED power		PIN 6	Ground
	PIN 7	HDD active		PIN 7	Speaker data
	PIN 8	Ground		PIN 8	No connection
	PIN 9	Power On/Off signal		PIN 9	+5VDC
	PIN 10	+3V Standby		PIN 10	Suspend LED active
	PIN 11	Suspend signal		PIN 11	No connection

Let's now see the I/O connectors that ZH6 uses, and what their functions are.

FDC1 Connector

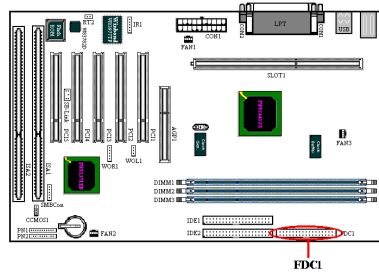

This 34-pin connector is called the “*floppy disk drive connector*”. You can connect a 360K, 5.25”, 1.2M, 5.25”, 720K, 3.5”, 1.44M, 3.5” or 2.88M, 3.5” floppy disk drive, you can even connect a 3 Mode floppy disk drive (it's a 3 1/2” drive used in Japanese computer systems).

A floppy disk drive ribbon cable has 34 wires and two connectors to provide for the connection of two floppy disk drives. After connecting the single end to the FDC1, connect the two connectors on the other end to the floppy disk drives. In general, people only install one floppy disk drive on their computer system.

Note

A red mark on a wire typically designates the location of pin 1. You need to align the wire pin 1 to the FDC1 connector pin 1, then insert the wire connector into the FDC1 connector.

IDE1 and IDE2 Connectors

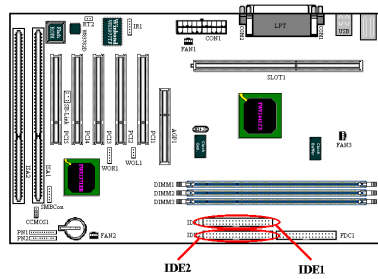

An IDE hard disk drive ribbon cable has 40 wires and two connectors to provide a connection for two IDE hard disk drives. After connecting the single end to the IDE1 (or IDE2), connect the two connectors on the other end to the IDE hard disk drives (or CD-ROM drive, LS-120, etc.).

Before you install a hard disk, there are some things you need to be aware of:

- ◆ “Primary” refers to the first connector on the motherboard, that is, the IDE1 connector on the motherboard.
- ◆ “Secondary” refers to the second connector on the motherboard, that is, the IDE2 connector on the motherboard.
- ◆ Two hard disks can be connected to each connector:
 - The first HDD is referred to as the “Master”,
 - The second HDD is referred to as the “Slave”.
- ◆ For performance issues, we strongly suggest you don’t install a CD-ROM drive on the same IDE channel as a hard disk. Otherwise, the system performance on this channel may drop. (how much depends on your CD-ROM drive performance)

Note

- The Master or Slave status of the hard disk drive is set on the hard disk itself. Please refer to the hard disk drive user’s manual.
- A red mark on a wire typically designates the location of pin 1. You need to align the wire pin 1 to the IDE connector pin 1, then insert the wire connector into the IDE connector.

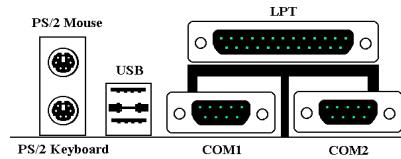
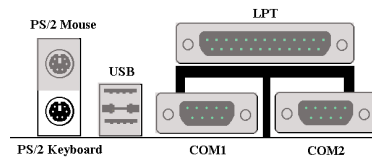

Figure 2-11. ZH6 back panel connectors

Figure 2-11 shows the ZH6 back panel connectors, these connectors are for connection to outside devices to the motherboard. We will describe which devices will attach to these connectors below.

KM1 Lower: PS/2 Keyboard Connector



Attach a PS/2 keyboard connector to this 6-pin Din-connector. If you use an AT keyboard, you can go to a computer store to purchase an AT to ATX converter adapter, then you can connect your AT keyboard to this connector. We suggest you use a PS/2 keyboard for best compatibility.

KM1 Upper: PS/2 Mouse Connector

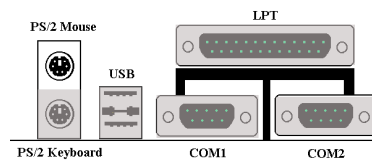

Attach a PS/2 mouse to this 6-pin Din-connector.

USB Port Connectors

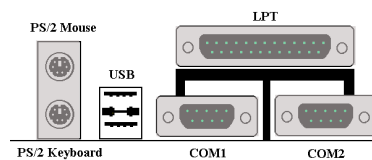

This motherboard provides two USB ports. Attach the USB connector from the individual device to these connectors. You can attach USB devices such as a scanner, monitor, mouse, keyboard, hub, CD-ROM, joystick etc. to one of each USB connector.

You must make sure your operating system supports this feature and you may need to install an additional driver for individual devices. Please refer to your device user's manual for detailed information.

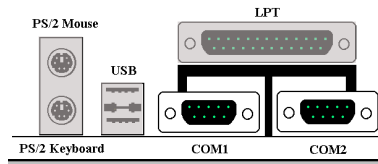
Serial Port COM1 and COM2 Connector

This motherboard provides two COM ports, you can connect an external modem, mouse or other devices that support this communication protocol.

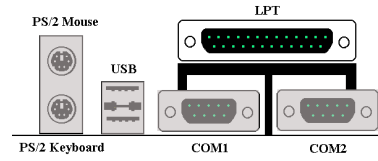
Parallel Port Connector

This parallel port is also called an “LPT” port, because it usually connects to the printer. You can connect other devices that support this communication protocol, like a scanner, M.O. drive, etc.

Chapter 3. Introduction of the BIOS

The BIOS is a program located on a Flash Memory chip on the motherboard. This program will not be lost when you turn the computer off. This program is also referred to as the boot program. It is the only channel for the hardware circuit to communicate with the operating system. Its main function is to manage the setup of the motherboard and interface cards parameters, including simple parameters such as time, date, hard disk drive, as well as more complex parameters such as hardware synchronization, device operating mode, **CPU SOFT MENU™ II** features and setup of CPU speed. The computer will operate normally, or will operate at its best, only if all these parameters are correctly configured through the BIOS.



Don't change the parameters inside the BIOS unless you fully understand their meanings and consequences

The parameters inside the BIOS are used to setup the hardware synchronization or the device operating mode. If the parameters are not correct, they will produce errors, the computer will crash, and sometimes you will even not be able to boot the computer after it has crashed. We recommend that you do not change the parameters inside the BIOS unless you are very familiar with them. If you are not able to boot your computer anymore, please refer to the section “Erase CMOS data” in Chapter 2.

When you start the computer, it is controlled by the BIOS program. The BIOS first operates an auto-diagnostic test called POST (Power On Self Test) for all the necessary hardware, it then configures the parameters of the hardware synchronization, and detects all the hardware. Only when these tasks are completed does it give up control of the computer to the program of the next level, which is the operating system (OS). Since the BIOS is the only channel for hardware and software to communicate, it will be the key factor for system stability, and in insuring that your system performs at its best. After the BIOS has achieved the auto-diagnostic and auto-detection operations, it will display the following message:

PRESS DEL TO ENTER SETUP

The message will be displayed for three to five seconds, if you press the **Del** key, you will access the BIOS Setup menu. At that moment, the BIOS will display the following message:

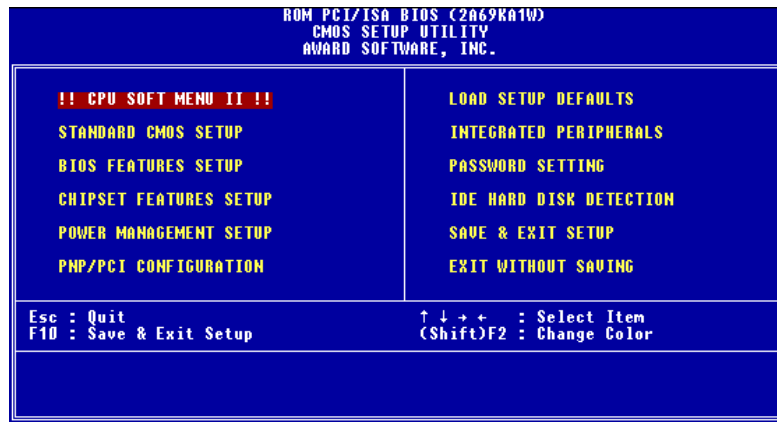

Figure 3-1. CMOS Setup Utility

In the BIOS Setup main menu of Figure 3-1, you can see several options. We will explain these options step by step in the following pages of this chapter, but let us first see a short description of the function keys you may use here:

- Press **Esc** to quit the BIOS Setup.
- Press **↑ ↓ ← →** (up, down, left, right) to choose, in the main menu, the option you want to confirm or to modify.
- Press **F10** when you have completed the setup of BIOS parameters to save these parameters and to exit the BIOS Setup menu.
- Press Page Up/Page Down or +/- keys when you want to modify the BIOS parameters for the active option.

Computer Knowledge: CMOS Data

Maybe you have heard somebody saying that their CMOS DATA was lost. What is the CMOS? Is it important? The CMOS is the memory used to store the BIOS parameters that you have configured. This memory is passive. You can read its data, and you can also store data in it. But this memory has to be powered by a battery, in order to avoid any loss of its data when the computer is turned off. Since you may have to change the CMOS battery when it is out of power and if doing so, you will loose all CMOS data, therefore, we recommend that you write down all the parameters of your hardware, or to put a label with these parameters on your hard disk.

3-1. CPU Setup [SOFT MENU™ II]

The CPU can be setup through a programmable switch (**CPU SOFT MENU™ II**), that replaces the traditional manual hardware configuration. This feature allows the user to more easily complete the installation procedures. You can install the CPU without configuring any jumpers or switches. The CPU must be setup according its specifications.

In the first option, you can press <F1> at any time to display all the items that can be chosen for that option.

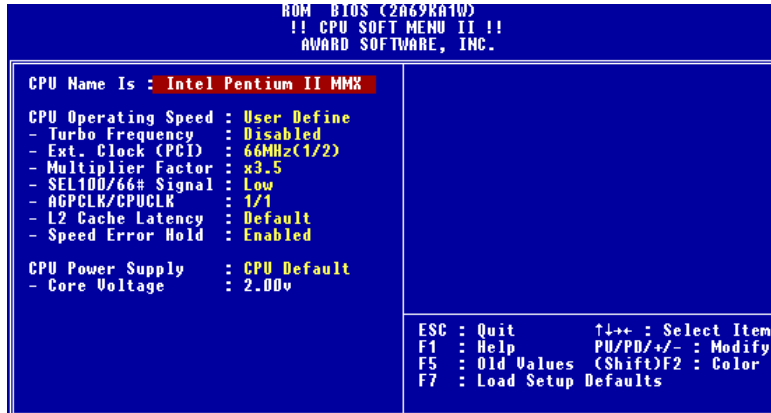

Figure 3-2. CPU SOFT MENU™ II

CPU Name Is:

- Intel Celeron MMX
- Intel Pentium II MMX
- Intel Pentium III MMX

CPU Operating Speed:

This option sets the CPU speed.

In this field, the CPU speed is indicated like this: CPU speed = External clock * Multiplier factor, select the CPU speed according the type and the speed of your CPU.



For Intel Pentium® II/III and Celeron® MMX processors, you can choose the following

settings:

- 233 (66) ➤266 (66) ➤300 (66) ➤300 (100) ➤333 (66)
- 350 (100) ➤366 (66) ➤400 (66) ➤400(100) ➤433 (66)
- 450 (100) ➤466 (66) ➤500 (66) ➤500 (100) ➤550 (100)
- User Define

User defined external clock and multiplier factor:

➤ **User Defined**

Warning

The wrong settings of the multiplier and external clock in certain circumstances may cause CPU damage. Setting the working frequency higher than the PCI chipset or processor specs, may cause abnormal memory module functioning, system hangs, hard disk drive data lose, abnormal functioning of the VGA card, or abnormal functioning with other add-on cards. Using non-specification settings for your CPU is not the intention of this explanation. These should be used for engineering testing, not for normal applications.

If you use non-specification settings for normal operation, your system may not be stable, and may effect system reliability. Also, we do not guarantee the stability and compatibility for settings that are not within specification, and any damage of any elements on the motherboard or peripherals, is not our responsibility.

☞ *Turbo Frequency:*

This item will only be displayed if your CPU external clock supports Turbo Mode.

The Turbo mode allows you to speed up the external clock by approximately 2.5%. This feature is used to verify the design flexibility. It is a very important tool for test units to verify CPU stability. Do not use this feature.

- Disabled: CPU external clock is operating within the normal limits.
- Enabled: CPU external clock is operating within the limits of the Turbo mode.

Note

The increase by 2.5% of the CPU speed is not a standard feature of this product. It is only for use by our development department to verify that the CPU is able to work normally when CPU speed, operating temperature and power supply are 2.5% higher or lower than the standard values. This is to guarantee product stability. We require the manufacturer of the Clock Generator to meet the demands of our development department and to add a TURBO Frequency feature used for testing purposes by our R&D department. Of course, you can use this feature to test the stability of your own system, but after you have tested the product, we recommend that you set it back to its normal value in order to guarantee system stability.

⇒ External Clock:

- 66MHz (1/2)
- 83MHz(1/2)
- 124MHz (1/3)
- 100MHz (1/3)
- 112MHz (1/3)
- 75MHz (1/2)
- 133MHz (1/3)

Note

CPU bus speed above 66MHz/100MHz supported but not guaranteed due to the PCI and chipset specs.

⇒ Multiplier Factor:

You can choose the following multiplier factors:

- 2.0 ➤ 2.5 ➤ 3.0 ➤ 3.5 ➤ 4.0 ➤ 4.5 ➤ 5.0 ➤ 5.5 ➤ 6.0
- 6.5 ➤ 7.0 ➤ 7.5 ➤ 8.0

However, differences will exist because of the various brands and types available.

⇒ SEL100/66# Signal:

This default setting is “High” at 100MHz, and “Low” at 66MHz. When you want to try a higher multiplier factor at 100MHz and cannot choose it in the “High” state, you can set it to the “Low” state.

Note

According to Celeron® PPGA MMX processor types, some Celeron® PPGA MMX processors will have the multiplier factor locked and the signal disabled. In this situation, there is no way to choose a higher multiplier factor.

⇒ *AGPCLK/CPUCLK:*

The default setting is “2/3”. In this state, the AGP bus speed will be the CPU bus speed divided by 3 and times 2. If you choose the setting to “1/1”, the AGP bus speed will equal to the CPU bus speed.

⇒ *L2 Cache Latency:*

Sixteen setting are available, Default, and 1 to 15. This item can let you adjust the processor L2 cache speed, the larger the value, the faster the L2 cache will run. You have to be aware that if you set the L2 cache speed too fast, it will cause the L2 cache to fail. If the L2 cache fails it will cease to run until you reset the value, but the processor and L1 cache will still function, just not as well. To make sure your L2 cache functions properly please choose an appropriate setting. The default setting is Default.

⇒ *Speed Error Hold:*

The default setting is “Disabled”. If you change the setting to “Enabled” when the CPU speed setting is wrong, the system will hold.

Normally, we do not recommend that you use the “User Define” option to setup CPU speed and multiplier factors. This option is for setup of future CPUs whose specifications are still unknown. The specifications of all present CPUs are included in the default settings. Unless you are very familiar with all CPU parameters, it is very easy to make mistakes when you define the external clock and the multiplier factor by yourself.

Solution in case of booting problem due to invalid clock setup:

Normally, if the CPU clock setup is wrong, you will not be able to boot. In this case, turn the system off then on again. The CPU will automatically use its standard parameters to boot. You can then enter the BIOS Setup again and set up the CPU clock. If you can't enter the BIOS setup, you must try turning the system on a few times (3~4 times) or press “INSERT” key when turning on and the system will automatically use its standard parameters to boot. You can then enter BIOS SETUP again and set up the new parameters.

When you change your CPU:

This motherboard has been designed in such a way that you can turn the system on after having inserted a CPU in the socket without having to configure any jumpers or DIP switches. But if you change your CPU, normally you just have to turn off the power supply, change the CPU and then, set up the CPU parameters through **SOFT MENU™ II**. However, if the new CPU is slower than the old one (and is same brand and type), we offer you two methods to successfully complete the CPU change operation.

Method 1: Setup up the CPU for the lowest speed for its brand. Turn the power supply off and change the CPU. Then turn the system on again, and set up the CPU parameters through **SOFT MENU™ II**.

Method 2: Since you have to open the computer case when you change the CPU, it could be a good idea to use the CCMOS jumper to erase the parameters of the original CPU and to enter BIOS Setup to set up CPU parameters again.

Attention

After setting up the parameters and leaving the BIOS SETUP, and having verified that the system can be booted, do not press the Reset button or turn off the power supply. Otherwise the BIOS will not read correctly, the parameters will fail and you must enter **SOFT MENU™ II** again to set up the parameters all over again.

CPU Power Supply:

This option allows you to switch between CPU default and user defined voltages.

- ▶ **CPU Default:** The system will detect the CPU type and select the proper voltage automatically. When it is enabled, the option “**Core Voltage**” will show the current voltage setting that is defined by the CPU and this will not be changeable. We recommend using this CPU default setting and not changing it unless the current CPU type and voltage setting can not be detected or is not correct.
- ▶ **User Define:** This option lets the user select the voltage manually. You can change values of the “**Core Voltage**” option lists by using the Page Up and Page Down keys.

3-2. Standard CMOS Setup Menu

This contains the basic configuration parameters of the BIOS. These parameters include the settings of date, hour, VGA card, FDD and HDD.

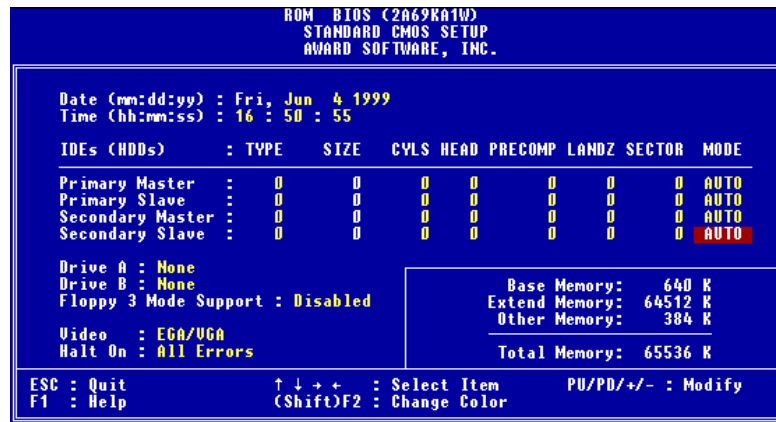

Figure 3-3. Standard CMOS Setup Menu

Date (mm:dd:yy):

You can set the date information in this item, month (mm), date (dd) and year (yy).

Time (hh:mm:ss):

You can set time information in this item, hour (hh), minute (mm) and second (ss).

Setup of the HDD operating mode [NORMAL, LBA, LARGE]

Since old operating systems were only able to support HDDs whose capacity was not bigger than 528MB, any hard disk with more than 528MB was unusable. AWARD BIOS features a solution to this problem: you can, according to your operating system, choose three operating modes: NORMAL, LBA or LARGE.

The HDD auto detection option in the Main Menu will automatically detect the parameters of your hard disk and the mode supported.

► Normal mode:

Standard normal mode supports hard disks of 528MB or less. This mode directly uses positions indicated by Cylinders (CYLS), Heads, and Sectors to access data.

► LBA (Logical Block Addressing) mode:

The earlier LBA mode can support HDDs capacity of up to 8.4GB, and this mode uses a different method to calculate the position of disk data to be accessed. It translates Cylinders (CYLS), Heads and Sectors into a logical address where data are located. The Cylinders, Heads, and Sectors displayed in this menu do not reflect the actual structure of the hard disk, they are just reference values used to calculate actual positions. Currently, all high capacity hard disks support this mode, that's why we recommend you use this mode. Currently, the BIOS can support the INT 13h extension function, enabling the LBA mode to support hard disk drive capacities exceeding 8.4GB.

► LARGE Mode:

When the number of cylinders (CYLS) of the hard disk exceeds 1024 and DOS is not able to support it, or if your operating system does not support LBA mode, you should select this mode.

Drive A:

If you have installed the floppy disk drive here, then you can select the type of floppy drive it can support. Six options are available: None → 360K, 5.25 in. → 1.2M, 5.25in. → 720K, 3.5 in. → 1.44M, 3.5 in. → 2.88M, 3.5 in. → Back to None.

Drive B:

If you have installed the floppy disk drive here, then you can select the type of floppy drive it can support. Six options are available: None → 360K, 5.25 in. → 1.2M, 5.25in. → 720K, 3.5 in. → 1.44M, 3.5 in. → 2.88M, 3.5 in. → Back to None.

FDD supporting 3 Mode:

3 Mode floppy disk drives (FDD) are 3 1/2" drives used in Japanese computer systems. If you need to access data stored in this kind of floppy, you must select this mode, and of course you must have a 3 Mode floppy drive.

Video:

You can select the VGA modes for your video adapter, four options are available: MONO → EGA/VGA → CGA 40 → CGA 80 → Back to MONO. The default setting is EGA/VGA.

Halt On:

You can select which type of error will cause the system to halt. Five options are available: All Errors → No Errors → All, But Keyboard → All, But Diskette → All, But Disk/Key → Back to All Errors.

You can see your system memory list in the lower right box, it shows the *Base Memory*, *Extended Memory* and *other Memory* size configuration in your system.

3-3. BIOS Features Setup Menu

In each item, you can press <F1> at any time to display all the options for this item.

Attention

BIOS Features Setup Menu has already been set for maximum operation. If you do not really understand each of the options in this menu, we recommend you use default values.

```

ROM PCI/ISA BIOS (2A69KA1W)
BIOS FEATURES SETUP
AWARD SOFTWARE, INC.

Virus Warning           : Disabled
CPU Level 1 Cache      : Enabled
CPU Level 2 Cache      : Enabled
CPU L2 Cache ECC Checking : Enabled
Quick Power On Self Test : Enabled
Boot Sequence          : A,C,SCSI
Swap Floppy Drive      : Disabled
Boot Up Floppy Seek    : Disabled
Boot Up NumLock Status : On
IDE HDD Block Mode     : Enabled
Typematic Rate Setting : Enabled
Typematic Rate (Chars/Sec) : 30
Typematic Delay (Msec) : 250
Security Option        : Setup
PCI/VGA Palette Snoop : Disabled
OS Select For DRAM > 64MB : Non-OS2
Report No FDD For WIN 95 : No
Delay IDE Initial (Sec) : 0
Processor Number Feature : Disabled

Video BIOS Shadow : Enabled
C8000-CBFFF Shadow : Disabled
CC000-CFFFF Shadow : Disabled
D0000-D3FFF Shadow : Disabled
D4000-D7FFF Shadow : Disabled
D8000-DBFFF Shadow : Disabled
DC000-DFFFF Shadow : Disabled

ESC : Quit      ↑↓↓+ : Select Item
F1  : Help      PU/PD/+/- : Modify
F5  : Old Values (Shift)F2 : Color
F7  : Load Setup Defaults

```

Figure 3-4. BIOS Features Setup

Virus Warning:

This item can be set as Enable or Disable.

When this feature is enabled, if there is any attempt from a software or an application to access the boot sector or the partition table, the BIOS will warn you that a boot virus is attempting to access to the hard disk.

CPU Level 1 Cache:

This item is used to Enable or to Disable the CPU level 1 cache. When the cache is set at Disable, it is much slower, so the default setting for this item is Enable. Some old and very poorly written programs will make the computer malfunction or crash if the system speed is too high. In that case, you should Disable this feature.

CPU Level 2 Cache:

This item is used to enable or to disable the CPU level 2 cache. When the external cache is enabled, the system works faster. The default is Enable.

CPU Level 2 Cache ECC Checking:

This item is used to enable or to disable the CPU level 2 cache ECC checking function.

Quick Power On Self Test:

After the computer has been powered on, the BIOS of the motherboard will run a series of tests in order to check the system and its peripherals. If the Quick power on self-test feature is Enable, the BIOS will simplify the test procedures in order to speed up the boot process. The default is Enable.

Boot Sequence:

When the computer boots up, it can load the operating system from the floppy drive A, hard drive, SCSI drive or CD-ROM. There are many options for the boot sequence:

- A, C, SCSI
 - C, A, SCSI
 - C, CD-ROM, A
 - CD-ROM, C, A
 - D, A, SCSI (At least 2 IDE HDD can be used)
 - E, A, SCSI (At least 3 IDE HDD can be used)
 - F, A, SCSI (At least 4 IDE HDD can be used)
 - SCSI, A, C
 - SCSI, C, A
 - A, SCSI, C
 - LS/ZIP, C
-

Swap Floppy Drive:

This item can be set as Enable or Disable.

When this feature is enabled, you don't need to open the computer case to swap the position of floppy disk drive connectors. Drive A can be set as drive B and drive B can be set as drive A.

Boot Up Floppy Seek:

When the computer boots up, the BIOS detects if the system has an FDD or not. When this item is enabled, if the BIOS detects no floppy drive, it will display a floppy disk drive error message. If this item is disabled, the BIOS will skip this test.

Boot Up NumLock Status:

- ▶ On: At boot up, the Numeric Keypad is in numeric mode.
- ▶ Off: At boot up, the Numeric Keypad is in cursor control mode.

IDE HDD Block Mode:

This item can be set as Enable or Disable.

Most of new hard disk drives (IDE drives) support multi-sector transfers. This feature speeds up hard disk drive access performance and reduces the time necessary to access data. When this item is enabled, the BIOS will automatically detect if your hard disk drive supports this feature or not, and will choose the right settings for you. (*The default is Disable*)

Typematic Rate Setting:

This item allows you to adjust the keystroke repeat rate. When enabled, you can set the two keyboard typematic controls that follow (Typematic Rate and Typematic Rate Delay). If this item is disabled, the BIOS will use the default setting.

Typematic Rate (Chars/Sec):

When you press a key continuously, the keyboard will repeat the keystroke according to the rate you have set. (Unit: characters/second)

Typematic Rate Delay (Msec):

When you press a key continuously, if you exceed the delay you have set here, the keyboard will automatically repeat the keystroke according to a certain rate. (Unit: milliseconds)

Security Option:

This option can be set to *System* or to *Setup*.

After you have created a password through PASSWORD SETTING, this option will deny access to your system (System) or modification of computer setup (BIOS Setup) by unauthorized users.

►**SYSTEM:** When you choose System, a password is required each time the computer boots up. If the correct password is not given, the system will not start.

►**SETUP:** When you choose Setup, a password is required only when accessing the BIOS Setup. If you have not set a password in the PASSWORD SETTING option, this option is not available.

Notice

Don't forget your password. If you forget the password, you will have to open the computer case and clear all information in the CMOS before you can start up the system. But by doing this, you will have to reset all the options you had set up before.

PCI/VGA Palette Snoop:

This option allows the BIOS to preview VGA Status, and to modify the information delivered from the Feature Connector of the VGA card to the MPEG Card. This option can solve the display inversion to black after you have used the MPEG card.

OS Select For DRAM > 64MB:

When the system memory is bigger than 64MB, the communication method between the BIOS and the operating system will differ from one operating system to another. If you use OS/2, select OS2; if you choose another operating system, select Non-OS2.

Report No FDD For WIN 95:

When using Windows 95 without floppy drive, please set this item to Yes.

Delay IDE Initial (Sec):

This item is used to support some old model or special type of hard disks or CD-ROMs, since the BIOS may not detect those kinds of devices during system booting.

Processor Number Feature:

This feature can let the program read the data inside your processor. This feature only works with Intel® Pentium® III processors. When you install a Pentium® III processor into your motherboard, and when your system boots-up then this item will show up in BIOS.

Two items will be available: Enabled and Disabled. When you choose Enabled, the specific program can read your processor's serial number. When you choose Disabled it will not allow the program to read your processor's serial number. The default setting is Disabled.

Video BIOS Shadow:

This option is used to define whether the BIOS on the video card uses the shadow feature or not. You should set this option to Enabled, otherwise the display performance of the system will greatly decrease.

Shadowing address ranges:

This option allows you to decide if the ROM BIOS area of an interface card at a specific address uses the shadow feature or not. If you have no interface card using this memory block, don't enable this option.

You have six address ranges you can select:

C8000-CBFFF Shadow, CC000-CFFFF Shadow, D0000-D3FFF Shadow, D4000-D7FFF Shadow, D8000-DBFFF Shadow, DC000-DFFFF Shadow.

Computer Knowledge: SHADOW

What is the SHADOW? The BIOS of standard video or interface cards is stored in ROM, and it is often very slow. With the Shadow feature, the CPU reads the BIOS on the VGA card and copies it into RAM. When the CPU runs this BIOS, the operation is speeded up.

3-4. Chipset Features Setup Menu

The Chipset Features Setup Menu is used to modify the contents of the buffers in the chipset on the motherboard. Since the parameters of the buffers are closely related to hardware, if the setup is not correct or is false, the motherboard will become unstable or you will not be able to boot up. If you don't know the hardware very well, use default values (i.e. use the LOAD SETUP DEFAULTS option).

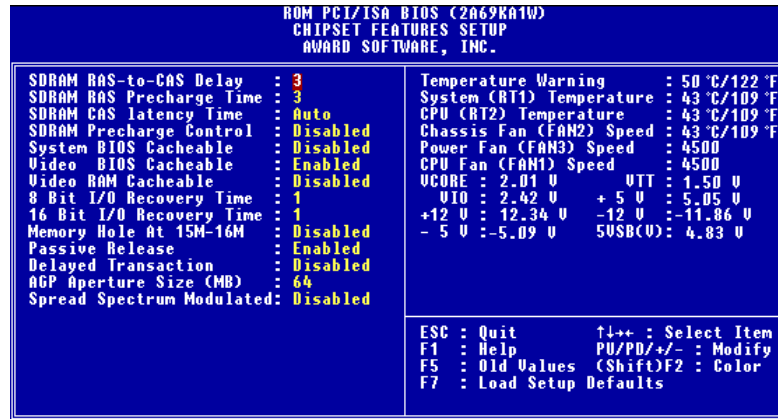

Figure 3-5. Chipset Features Setup

You can use the arrow keys to move between the items. Use **PgUP**, **PgDn**, **+** or **-** key to change the values. When you have finished setting up the chipset, press **ESC** to go back to the main menu.

SDRAM RAS-to-CAS Delay:

This field lets you control the number of DCLKs between a Row Active command and a read or write command.

SDRAM RAS Precharge Time:

The precharge time is the number of cycles it takes for the RAS to accumulate its charge before DRAM refresh. If insufficient time is allowed, refresh may be incomplete and the DRAM may fail to retain data. This field applies only if synchronous DRAM is installed in the system.

SDRAM CAS latency Time:

Two options are available: 2 and 3. You can select SDRAM CAS (Column Address Strobe) latency time according your SDRAM specification.

SDRAM Precharge Control:

Two options are available: Enabled and Disabled. This option specifies the length of the RAS precharge part of the DRAM system memory access cycle when SDRAM system memory is installed on the motherboard. The default setting is Disabled.

System BIOS Cacheable:

You can select Enable or Disable. When you select Enabled, you get faster system BIOS executing speed via the L2 cache.

Video BIOS Cacheable:

You can select Enable or Disable. When you select Enabled, you get faster video BIOS executing speed via the L2 cache.

Video RAM Cacheable:

You can select Enable or Disable. When you select Enabled, you get faster video RAM executing speed via the L2 cache. You must check your VGA adapter manual to find out if any compatibility problems will occur.

8 Bit I/O Recovery Time:

Nine options are available: NA → 8 → 1 → 2 → 3 → 4 → 5 → 6 → 7 → Back to NA. This option specifies the length of a delay inserted between consecutive 8 bit I/O operations. For an earlier 8 bit Add-on card, sometimes you need to adjust its recovery time to make it work normally.

16 Bit I/O Recovery Time:

Five options are available: NA → 4 → 1 → 2 → 3 → Back to NA. This option specifies the length of a delay inserted between consecutive 16 bit I/O operations. For an earlier 16 bit Add-on card, sometimes you need to adjust its recovery time to make it work normally.

Memory Hole At 15M-16M:

This option is used to free up the memory block 15M-16M. Some special peripherals need to use a memory block located between 15M and 16M, and this memory block has a size of 1M. We recommend that you disable this option.

Passive Release:

Two options are available: Enabled and Disabled. Set the option to enabled or disabled passive release for the Intel PIIX4 chip (Intel PCI to ISA bridge). This function is used to meet the latency of the ISA bus master, if you have an ISA card compatibility problem, you can try to enable or disable this option for optimal result.

Delayed Transaction:

Two options are available: Enabled and Disabled. Set the option to enabled or disabled delayed transaction for the Intel PIIX4 chip. This function is used to meet the latency of PCI cycles to or from the ISA bus. This option must be enabled to provide PCI 2.1 compliance. If you have an ISA card compatibility problem, you can try to enable or disable this option for optimal results.

AGP Aperture Size (MB):

Seven options are available: 4 → 8 → 16 → 32 → 64 → 128 → 256 → Back to 4. This option specifies the amount of system memory that can be used by the AGP device. The aperture is a portion of the PCI memory address range dedicated for graphics memory address space.

Spread Spectrum:

Three options are available: Disable → 0.25% → 0.5%. For EMC (Electro-Magnetic Compatibility Test) testing you may need to adjust these options for optimal results, we do not recommend you change the default, except for special reasons. Some values you select may cause system instability under some situations, please be careful.

Temperature Warning:

This item lets you select the temperature that you want the system to send out to the PC speakers a warning message of when the temperature goes beyond either limit. You can

select the temperatures you want, they are any from 30°C / 86°F to 120°C / 248°F. It lets you increase by one step increments, 1°C / 1.8°F.

Thermal, Fans Speed and Voltages Monitor:

These items list current states of CPU and system temperature as well as fan speed (CPU fan and chassis fan). It can not be changed by the user.

The following items list the voltage states of the system power. Just like Thermal & Fan Monitor, it is unchangeable.

Note

The hardware monitoring features for temperature, fans and voltages will occupy the I/O address from 294H to 297H. If you have a network adapter, sound card or other add-on cards that might use those I/O addresses, please adjust your add-on card I/O address, to avoid the use of those addresses.

There are small differences in the chipset feature setup according to different motherboard models, but this has no influence upon performance. Our default setup should be the best one.

3-5. Power Management Setup Menu

The difference between Green PCs and traditional computers is that Green PCs have a power management feature. With this feature, when the computer is powered on but inactive, the power consumption is reduced in order to save energy. When the computer operates normally, it is in Normal mode. In this mode, the Power Management Program will control the access to video, parallel ports, serial ports and drives, and the operating status of the keyboard, mouse and other device. These are referred to as Power Management Events. In cases where none of these events occur, the system enters the power saving mode. When one of the controlled events occurs, the system immediately returns to normal mode and operates at its maximum speed. Power saving modes can be divided into three modes according to their power consumption: Doze Mode, Standby Mode, and Suspend Mode. The four modes proceed in the following sequence:

Normal Mode ==> Doze Mode ==> Standby Mode ==> Suspend Mode



The system consumption is reduced according the following sequence:

Normal > Doze > Standby > Suspend

1. In the Main Menu, select "Power Management Setup" and press "Enter". The following screen is displayed:

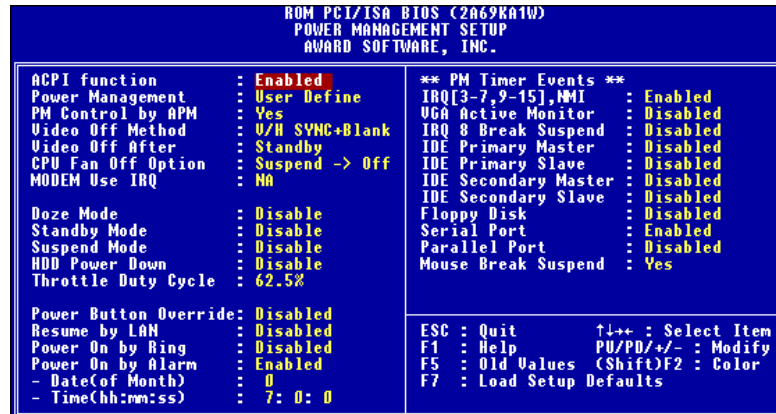

Figure 3-6. Power Management Setup Menu

2. Use the arrow keys to go to the item you want to configure. To change the settings, use **PgUP**, **PgDn**, + or - key.
3. After you have configured the Power Management feature, press **Esc** to go back to the Main Menu.

We are now going to briefly explain the options in this menu:

ACPI Function (Advanced Configuration and Power Interface):

ACPI gives the operating system direct control over the power management and Plug and Play functions of a computer.

There are two options that can be selected, "Enabled" and "Disabled". You can select "Enabled" to enable ACPI functions. If you want ACPI functions to work normally, you should notice two things. One is your operating system must support ACPI, as of now only Microsoft® Windows® 98 supports these functions. The second thing is that all devices and add-on cards in your system, must fully support ACPI, both hardware and software (drivers). If you want to know if your devices or add-on cards support ACPI or not, please contact the device or add-on card manufacture for more information. If you want to know more about ACPI specifications, please go to the address below for more detailed information:

<http://www.teleport.com/~acpi/acpihtml/home.htm>

ACPI requires an ACPI-aware operating system. ACPI features include:

- Plug and Play (including bus and device enumeration) and APM functionality normally contained in the BIOS.
- Power management control of individual devices, add-in cards (some add-in cards may require an ACPI-aware driver), video displays, and hard disk drives.
- A Soft-off feature that enables the operating system to power off the computer.
- Support for multiple wake up events (see Table 5-1).
- Support for a front panel power and sleep mode switch. Table 5-2 describes the system states based on how long the power switch is pressed, depending on how ACPI is configured with an ACPI-aware operating system.

Note

If you enable the ACPI function in the BIOS setup, the SMI switch function will not work.

System States and Power States

Under ACPI, the operating system directs all system and device power state transitions. The operating system puts devices in and out of low-power states based on user preferences and knowledge of how devices are being used by applications. Devices that are not being used can be turned off. The operating system uses information from applications and user settings to put the system as a whole into a low-power state.

Table 5-1: Wake Up Device and Events

The table below describes which devices or specific events can wake the computer from specific states.

These device/events can wake up the computer.....from this state
Power switch	Sleeping mode or power off mode
RTC alarm	Sleeping mode or power off mode
LAN	Sleeping mode or power off mode
Modem	Sleeping mode or power off mode
IR command	Sleeping mode
USB	Sleeping mode
PS/2 keyboard	Sleeping mode
PS/2 mouse	Sleeping mode
Sleep button	Sleeping mode

Table 5-2: Effect of Pressing the Power Switch

If the system is in this state.....and the power switch is pressed forthe system enters this state
Off	Less than four seconds	Power on
On	More than four seconds	Soft off/Suspend
On	Less than four seconds	Fail safe power off
Sleep	Less than four seconds	Wake up

Power Management:

Four options:

► User Define

User Define defines the delay for accessing the power modes.

► Min Saving

When the three saving modes are enabled, the system is set up for minimum power savings.

Doze = 1 hour
Standby = 1 hour
Suspend = 1 hour

► Max Saving

When the three saving modes are enabled, the system is set up for maximum power savings.

Doze = 1 minute
Standby = 1 minute
Suspend = 1 minute

► Disable

Disable the power management function.

PM Control by APM:

Power Management is completely controlled by the APM.

APM stands for Advanced Power Management, it is a power management standard set by Microsoft, Intel and other major manufacturers.

Video Off Method:

Three video off methods are available: "Blank Screen", "V/H SYNC + Blank" and "DPMS". The default is "V/H SYNC + Blank".

If this setting does not shut off the screen, select "Blank Screen". If your monitor and video card support DMPS standard, select "DPMS".

Video Off After:

Select the saving mode in which the video is switched off.

► NA

The video will never be switched off in no power saving mode.

► Suspend

The video will only be switched off in Suspend mode.

► Standby

The video will only be switched off in Standby or Suspend mode.

► Doze

The video will be switched off in all power saving modes.

CPU Fan Off Option:

CPU fan can be turned off in suspend mode.

Modem Use IRQ:

You can specify the IRQ for modem use.

Doze Mode:

When the setting selected for "Power Management" is "User Define", you can define for this mode any delay from 1 minute to 1 hour. If no power management event occurs during this time period, meaning that the computer is inactive during this period, the system will enter the Doze power saving mode. If this mode is disabled, the system will enter the next mode in the sequence (Standby or Suspend mode).

Standby Mode:

When the setting selected for "Power Management" is "User Define", you can define for this mode any delay from 1 minute to 1 hour. If no power management event occurs during this time period, meaning the computer is inactive during this period, the system will enter the Standby power saving mode.

If this mode is disabled, the system will enter the next mode in the sequence (Suspend mode).

Suspend Mode:

When the setting selected for "Power Management" is "User Define", you can define for this mode any delay from 1 minute to 1 hour. If no power management event occurs during this time period, meaning the computer is inactive during this period, the system will enter the Suspend power saving mode. The CPU stops working completely.

If this mode is disabled, the system will not enter the Suspend mode.

HDD Power Down:

If the system has not accessed data on the hard disk drive during the specified time period, the engine of the HDD will stop in order to save electricity. You can set 1 to 15 minutes or select Disable according to your use of the HDD.

Throttle Duty Cycle:

This is used to specify the CPU speed in power saving mode. Six options are available: 12.5%, 25.0%, 37.5%, 50.0%, 62.5% or 75.0% .

Power Button Override:

It is activated when the user presses the power button for more than four seconds while the system is in the working state, then the system will transition to the soft-off (Power off by software). This is called the power button over-ride.

Resume by LAN:

To enable this feature, you must make sure your network software and network adapter (LAN card) support such a function. This function is also called “ Wake on LAN “ (WOL).

Power on by Ring:

If you connect an external modem to the onboard serial port, the system will be turned on when a telephone ring-up occurs.

Power on by Alarm:

The RTC alarm can turn on the system. You can set date (of month) and time (hour, minute, and second).

PM Timer Events:

When one of the specified events occur, the count down made for entry in power saving mode goes back to zero. Since the computer will enter a power saving mode only after an inactivity delay specified (time specific for Doze, Standby and Suspend modes) and after it has no activity, during this time period, any event will cause the computer to re-count the time elapsed. Resume events are operations or signals that cause the computer to resume time counting.

► **IRQ [3-7, 9-15], NMI:**

If any IRQ or NMI (Non-Mask Interrupt) activities occur, this will cause the computer to re-count the time elapsed.

► **VGA Active Monitor:**

If there is any VGA data transfer or any I/O activities, this will cause the computer to re-count the time elapsed.

► **IRQ8 Break Suspend:**

Supports the RTC alarm wake up from suspend function (via IRQ8).

► **IDE Primary Master:**

If any IDE primary master I/O activity occurs, it will cause the computer to re-count the time elapsed.

► **IDE Primary Slave:**

If any IDE primary slave I/O activity occurs, it will cause the computer to re-count the time elapsed.

► **IDE Secondary Master:**

If any IDE secondary master I/O activity occurs, it will cause the computer to re-count the time elapsed.

► **IDE Secondary Slave:**

If any IDE secondary slave I/O activity occurs, it will cause the computer to re-count the time elapsed.

► **Floppy Disk:**

If any floppy disk I/O activity occurs, it will cause the computer to re-count the time elapsed.

► **Serial Port:**

If any serial port I/O activity occurs, it will cause the computer to re-count the time elapsed.

► **Parallel Port:**

If any Parallel port I/O activity occurs, it will cause the computer to re-count the time elapsed.

► **Mouse Break Suspend:**

Four options are available: Yes → No (COM1) → No (COM2) → No (PS/2) → **Back to Yes**.

3-6. PNP/PCI Configuration

In this menu, you can change the INT# and IRQ of the PCI bus and other hardware settings.

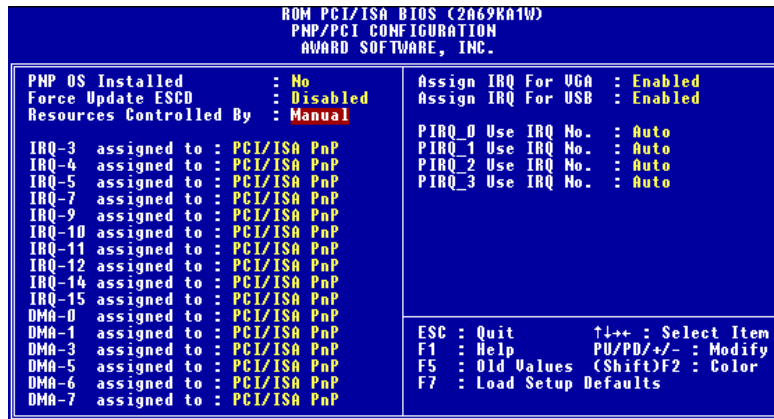

Figure 3-7. PNP/PCI Configuration Menu

PNP OS Installed:

Device resource assigned by PnP OS or BIOS.

Force Update ESCD:

If you want to clear ESCD data next time you boot up, and ask the BIOS to reset the settings for the Plug & Play ISA Card and the PCI Card, select Enabled. But the next time you boot up, this option will automatically be set as Disabled.

Computer Knowledge: ESCD (Extended System Configuration Data)

The ESCD contains the IRQ, DMA, I/O port, memory information of the system. This is a specification and a feature specific to the Plug & Play BIOS.

Resources Controlled By:

When resources are controlled manually, assign each system interrupt as one of the following types, depending on the type of device using the interrupt:

Legacy ISA devices compliant with the original PC AT bus specification, requiring a specific interrupt (such as IRQ4 for serial port 1).

PCI/ISA PnP devices compliant with the Plug and Play standard, whether designed for the PCI or ISA bus architecture.

Two options are available: Auto or Manual. The Award Plug and Play BIOS has the capability to automatically configure all of the boot and Plug and Play compatible devices. If you select Auto, all the interrupt request (IRQ) and DMA assignment fields disappear, as the BIOS automatically assigns them. But if you have trouble in assigning the interrupt resource automatically, you can select Manual to set which IRQ and DMA are assigned to PCI/ISA PnP or legacy ISA cards.

Assign IRQ For VGA :

You can assign an IRQ for the PCI VGA or *Disabled*.

Assigned IRQ For USB:

If you need another IRQ to be freed up, you can choose to disable this item, and you can get an IRQ. But in some situations in Windows® 95 it may cause the USB port to malfunction or have other problems! Two options are available: Enable or Disable.

PIRO_0 Use IRQ No. ~ PIRO_3 Use IRQ No:

This item allows you to specify the IRQ number for the device installed on PCI slots. Which means, you can specify the fixed IRQ number for the device installed on the PCI slots (PCI slot 1 to PCI slot 5, including the AGP slot). This is a useful function when you want to fix the IRQ for a specific device.

For example, if you want to remove your hard disk to another computer and don't want to re-install the Windows® NT 4.0 (and lower versions), then you can specify the IRQ for device install on the new computer to fit original computer settings.

Note

If you specify the IRQ in this item, then you cannot specify the same IRQ to the ISA bus, otherwise, it will cause a hardware conflict.

You must be familiar with the PCI interrupt distribution mechanism to adjust this setting. This feature is for the operating system which will record and fix the PCI configuration

status, if you want to change it.

For the relations between the hardware layout of PIRQ (the signals from the PIIX4 chipset), INT# (means PCI slot IRQ signals) and devices, please refer to the table below:

Signals	PCI slot 1 AGP slot	PCI slot 2	PCI slot 3	PCI slot 4 PCI slot 5
PIRQ_0	INT A	INT D	INT C	INT B
PIRQ_1	INT B	INT A	INT D	INT C
PIRQ_2	INT C	INT B	INT A	INT D
PIRQ_3	INT D	INT C	INT B	INT A

- USB used PIRQ_4.
- Each PCI slot has four INT#s (INT A~INT D), and the AGP slot has two INT# (INTA and INT B).

Note: 5 PCI Slots

Although the ZX chipset only supports 4 PCI bus master signals, the ZH6 offers users an additional PCI slot. Why? Because many Add-on cards such as the Voodoo series of graphics cards, some PCI-VGA and LAN cards don't occupy the bus master signal. So ABIT provides our customer better expandability by offering an extra PCI slot.

3-7. Load Setup Defaults

Setup defaults are the settings that allow your system to operate at its highest performance. When you choose this option, the following message is displayed:

“Load Setup Defaults (Y/N)? N”

If you want to use BIOS Setup default values, press “Y”, then <Enter> to complete the loading of the settings for best performance.

You should first load the best settings, than enter the CPU Soft Menu to set up CPU parameters, otherwise the BIOS will replace set parameters by default parameters.

3-8. Integrated Peripherals

In this menu, you can change the onboard I/O device, I/O port address and other hardware settings.

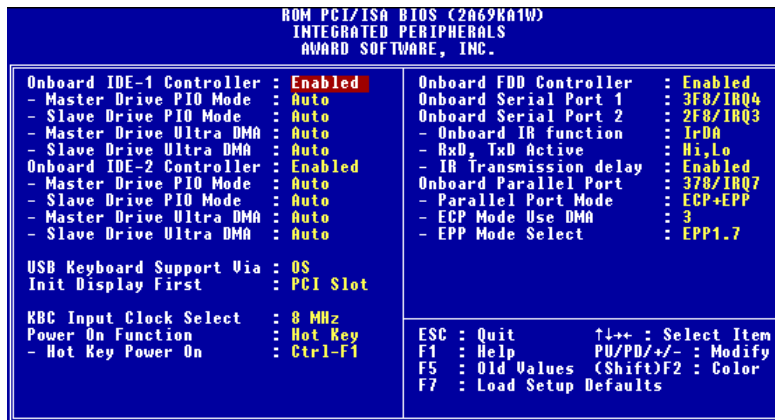

Figure 3-8. Integrated Peripherals Menu

Onboard IDE-1 Controller:

The onboard IDE 1 controller can be set as Enabled or Disabled.

☛ Master Drive PIO Mode:

►Auto: The BIOS can auto-detect the transfer mode of the IDE devices in order to set its data transfer rate. (Default)

You can select the PIO mode from 0 to 4 of the IDE devices in order to set its data transfer rate.

☛ Slave Drive PIO Mode:

►Auto: The BIOS can auto-detect the transfer mode of the IDE devices in order to set its data transfer rate. (Default)

You can select the PIO mode from 0 to 4 of the IDE devices in order to set its data transfer rate.

☛ Master Drive Ultra DMA:

Ultra DMA is a DMA data transfer protocol that utilizes ATA commands and the ATA bus to allow DMA commands to transfer data at a maximum burst rate of 33 MB/sec.

- ▶Auto: When you select *Auto*, the system automatically determines the optimal data transfer rate for each IDE device. (Default)
- ▶Disabled: If you encounter the problem of using Ultra DMA devices, you can try to *Disable* this item.

⇒ Slave Drive Ultra DMA:

- ▶Auto: When you select *Auto*, the system automatically determines the optimal data transfer rate for each IDE device. (Default)
- ▶Disabled: If you encounter the problem of using Ultra DMA devices, you can try to *Disable* this item.

Onboard IDE-2 Controller:

The onboard IDE-2 controller can be set at Enabled or Disabled.

⇒ ***Master Drive PIO Mode:***

- ▶Auto: The BIOS can auto-detect the transfer mode of the IDE devices in order to set its data transfer rate. (Default)

You can select the PIO mode from 0 to 4 of the IDE devices in order to set its data transfer rate.

⇒ ***Slave Drive PIO Mode:***

- ▶Auto: The BIOS can auto-detect the transfer mode of the IDE devices in order to set its data transfer rate. (Default)

You can select the PIO mode from 0 to 4 of the IDE devices in order to set its data transfer rate.

⇒ ***Master Drive Ultra DMA:***

Ultra DMA is a DMA data transfer protocol that utilizes ATA commands and the ATA bus to allow DMA commands to transfer data at a maximum burst rate of 33 MB/sec.

- ▶Auto: When you select *Auto*, the system automatically determines the optimal data transfer rate for each IDE device. (Default)
- ▶Disabled: If you encounter a problem using Ultra DMA devices, you can try to *Disable* this item.

⇒ ***Slave Drive Ultra DMA:***

- ▶Auto: When you select *Auto*, the system automatically determines the optimal data transfer rate for each IDE device. (Default)
- ▶Disabled: If you encounter the problem of using Ultra DMA devices, you can try to *Disable* this item.

PIO MODE 0~4 reflects the IDE device data transfer rate. The higher the MODE value is, the better is the IDE device data transfer rate. But it does not mean that you can select the highest MODE value just as you like, you first have to be sure that your IDE device supports this MODE, otherwise the hard disk will not be able to operate normally.

USB Keyboard Support Via:

You can choose either the OS or the BIOS to support the USB keyboard. Depending on the situation. Two options are available: *OS* or *BIOS*, *OS* is the default setting. With the *BIOS* option, you can use a USB keyboard under the MS-DOS environment but don't need to install a driver.

Init Display First:

When you install more than one display cards, you can choose either a PCI display card or an AGP display card to activate the display boot-up screen. If you only installed one display card, the BIOS will detect which slot (AGP or PCI) you installed it, in then everything will be take care of by the BIOS.

KBC Input Clock Select:

This item allows you to change the keyboard clock, if you have a keyboard problem, like keyboard failure, slow typing response time, etc. You may try to change the keyboard clock settings for optimal result.

Power On Function:

This item allows you to select which way you want your system to power on. Five items are available: Button Only → Keyboard 98 → Hot Key → Mouse Left → Mouse Right. Default setting is *Button Only*.

Note

The mouse wake up function can only be used with the PS/2 mouse, not with a mouse that uses the COM port and USB connection. *Mouse Left (Mouse Right)* means, you need to double click the mouse *left (right)* button, for the computer to power on. You also need to note the compatibility issue with your PS/2 mouse, some PS/2 mice cannot wake up the system, because of compatibility problems. If the spec. of your keyboard is too old, you may fail to power on.

⇒ Keyboard 98:

If you are using Windows® 98 and you have a keyboard that is designed for the Windows® 98 operating system. You can enable this item, and use your keyboard wake up key to wake up your computer.

⇒ Hot Key Power On:

There are twelve options are available, Ctrl-F1 to Ctrl-F12. You can select this item and using the Ctrl plus the one of each function key (F1 to F12) to power on the computer.

Onboard FDD Controller:

This is to Enable or Disable the Onboard FDD Controller.

Onboard Serial Port 1:

This is used to specify the I/O address and IRQ of Serial Port 1. Ten options are available: Disable, 3F8h/IRQ4, 2F8h/IRQ3, 3E8h/IRQ4 or 2E8h/IRQ3, 3F8h/IRQ10, 2F8h/IRQ11, 3E8h/IRQ10, 2E8h/IRQ11, and AUTO.

Onboard Serial Port 2:

This is used to specify the I/O address and IRQ of Serial Port 1. Ten options are available: Disable, 3F8h/IRQ4, 2F8h/IRQ3, 3E8h/IRQ4 or 2E8h/IRQ3, 3F8h/IRQ10, 2F8h/IRQ11, 3E8h/IRQ10, 2E8h/IRQ11, and AUTO.

⇒ Onboard IR Function:

Three options are available:

- IrDA (HPSIR) mode.
- ASK IR (Amplitude Shift Keyed IR) mode.
- Disabled.

⇒ RxD, TxD Active:

Set IR transmission/reception polarity as High or Low.

⇒ IR Transmission Delay:

Set IR transmission delays 4 character-time(40 bit-time) when SIR is changed from RX mode to TX mode.

Onboard Parallel Port:

Sets the I/O address and IRQ of the onboard parallel port. Four options are available:

Disable, 3BCh/IRQ7, 278h/IRQ5 and 378h/IRQ7. Default is 378h/IRQ7.

☞ **Parallel Port Mode:**

Can be set as ECP, EPP, ECP+EPP, or Normal (SPP) mode. Default is Normal (SPP) mode.

☞ **ECP Mode Use DMA:**

When the mode selected for the onboard parallel port is ECP, the DMA channel selected can be Channel 1 or Channel 3.

☞ **EPP Mode Select:**

When the mode selected for the onboard parallel port is EPP, two EPP version options are available: EPP1.7 and EPP1.9.

3-9. Password Setting

This option allows you to set a password required to start the system (System) or to access to the BIOS (Setup).

After you have set a password through the PASSWORD SETTING option, you can enter the Security Option in the “BIOS Features Setup Menu” to select the security level in order to prevent any unauthorized access.

Password setting procedure:

When you choose the Password setting option, the following message is displayed:

“Enter Password:“

Type your password. When complete, press <Enter>. The following message is displayed:

“Confirm Password:“

Type your password again. When complete, press <Enter>. The password setting is completed.

Password clearing procedure:

When you select the Password setting option, the following message is displayed:

“Enter Password:“

Press <Enter>, the message “Password Disable” is displayed. Press a key. The password clearing procedure is completed.

Notice

Do not forget your password. If you forget it, you will have to open the computer case, clear the contents of the CMOS, and boot the system up again. By doing this, you must reset all your parameters.
--

3-10. IDE Hard Disk Detection

After you have installed the hard disk, in old systems, you had to know the hard disk specifications, such as the number of cylinders, heads and sectors, and to enter the relevant information into the hard disk information section. If the CMOS data was erased, and you had forgotten the hard disk specifications, it was a great problem. But now, you can use this option to auto detect the hard disk type and specifications, and the BIOS will automatically detect all the relevant information and place them in the Hard Disk data section of the *Standard CMOS Setup Menu*. In order to allow you to use your hard disk.

3-11. Save & Exit Setup

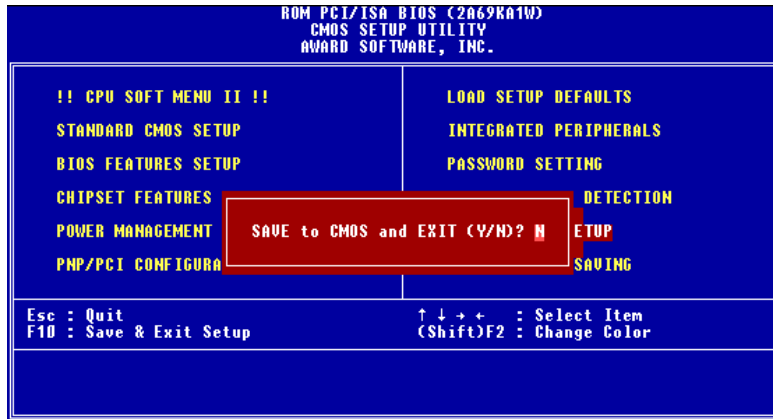

Figure 3-9. Save & Exit Setup

You can save all your selection to CMOS and exit BIOS to reboot your computer.

3-12. Exit Without Saving

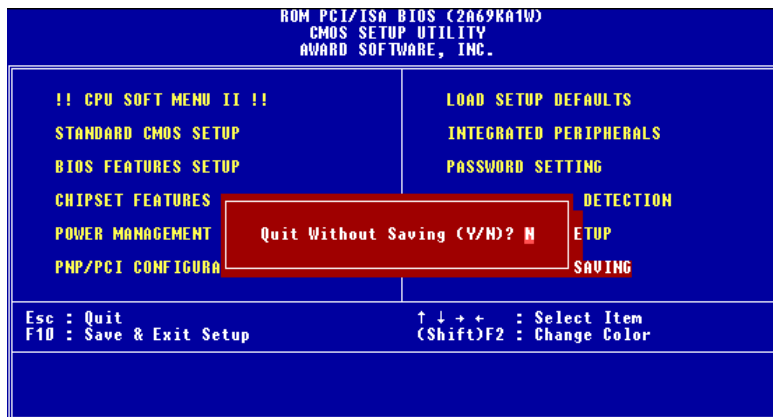

Figure 3-10. Exit Without Saving

You can exit and without saving all your selection to CMOS, then exit BIOS to reboot your computer.

Appendix A BIOS Flashing User Instructions

When your motherboard needs to be upgraded with new features or to fix some compatibility problems of the BIOS, you will need to use this BIOS flash utility. This utility is provided by Award Software, and it's easy to flash by yourself. But you have to read all the information within this section before flashing.

Before you can flash the BIOS you need to first go into the *pure DOS environment* by rebooting your system and going directly into DOS. Basically, there are two ways to flash your BIOS. One is to directly type the full line commands that are described in this section. The utility will then flash your BIOS. When you finish the flash operation, you will see the screen as in Figure A-2 ^{Note A-1}.

The other method is to just type *awdflash* (under Award flash BIOS utility directory) then press enter, the Flash Memory Writer V7.05 screen will show up, please refer to Figure A-1 ^{Note A-1}. You need to type "NEWBIOS" (the file name or you can use another name if you choose) into the "File Name to Program", then press enter. When you finish the flash operation, you will see the screen as in Figure A-2.

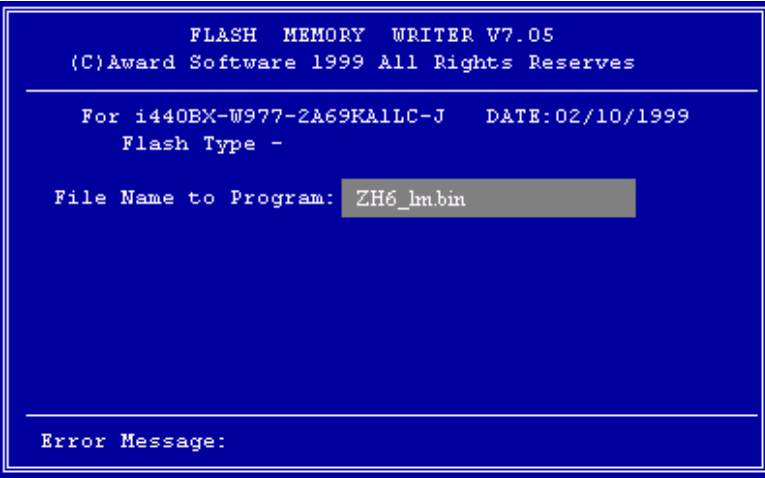

```
FLASH MEMORY WRITER V7.05
(C)Award Software 1999 All Rights Reserves

For i440BX-W977-2A69KALLC-J   DATE:02/10/1999
Flash Type -

File Name to Program: ZH6_hm.bin

Error Message:
```

Figure A-1. Award Flash Memory Writer V7.05 Start Screen

When you have finished updating your BIOS, you will see the screen as in Figure A-2. You then need to press the *F1* key to reset the system, or press the *F10* key to exit the writer.

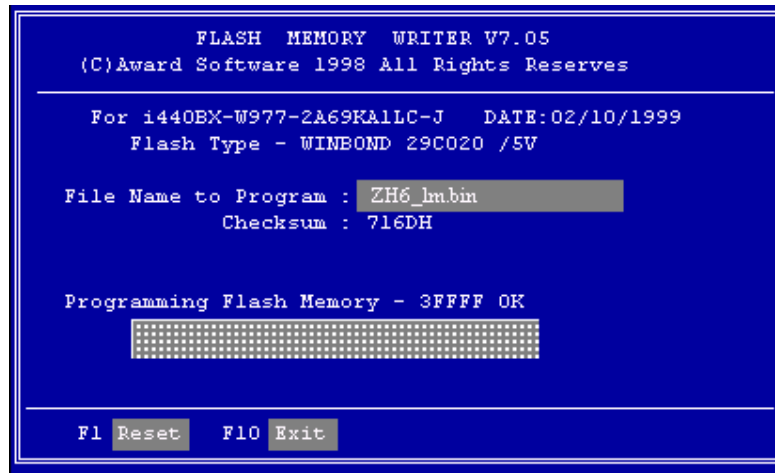

Figure A-2. Award Flash Memory Writer V7.05 Complete Screen

Figure A-3 shows you what commands you can use for the flashing program, you need to go into the pure DOS environment and type *awdf flash*, then you will see Figure A-3.



Figure A-3. Flash Commands Screen

Note A-1

The BIOS file name in the figure shown to you is only an example, you should check which .bin file is to be used with your motherboard, don't flash with the wrong .bin file. Otherwise, you may cause system malfunctions. Even the same models BIOS, according to its release date and according to which problems are fixed, also have different .bin names. Please read the BIOS file description before you download it.

Example 1: To update the BIOS and create a backup of the current system BIOS execute this command:

```
AWDFLASH NEWBIOS /PY SAVEBIOS /SY
```

Example 2: To update the BIOS, create a backup of current system BIOS, and clear the CMOS, execute this command:

```
AWDFLASH NEWBIOS SAVEBIOS /CC
```

Example 3: To update the BIOS and clear PnP settings execute this command:

```
AWDFLASH NEWBIOS /SN /CP
```

Example 4: To make a backup of the current system BIOS execute the following command:

```
AWDFLASH NEWBIOS /PN SAVEBIOS
```

Notes A-2

“NEWBIOS” indicates the file name for the new BIOS which can be downloaded from our web site at <http://www.abit.com.tw> (the user can choose a different file name in place of NEWBIOS). “SAVEBIOS” indicates the filename of the old system BIOS (the user can choose a different file name in place of SAVEBIOS).

Explanation of parameter names:

/CC: Clears CMOS data

/CP: Clears PnP data

/CD: Clears DMI data

Remarks:

1. When executing AWDFLASH.EXE, do not run HIMEM.SYS and EMM386.EXE in the

CONFIG.SYS.

2. Please take the following actions to solve problems caused by power shortage or other non-preventable malfunctions during BIOS updating that lead to update failure. First, it is strongly suggested that you format a disk that can boot your computer before you update your BIOS. If the above mentioned problem occurs during BIOS updating you will be able to use this disk to automatically execute a BIOS update. The content of the disk should be the following:

- (1) Startup system files (COMMAND.COM, MSDOS.SYS, IO.SYS ...)
- (2) AWDFLASH.EXE
- (3) The NEWBIOS file which can be download from ABIT web site.
- (4) AUTOEXEC.BAT, which has the following content:

A:\AWDFLASH NEWBIOS /PY /SN /CC /CD

For example, to update the ZH6 BIOS version to FZ (ZH6_LM.BIN), you need to type:

A:\AWDFLASH ZH6_LM.BIN /PY /SN /CC /CD

3. If you try to flash a version of BIOS that is for the incorrect motherboard model the following message will appear:

“The program file’s part number does not match with your system!”

Appendix B Installing the HighPoint XStore Pro Utility

We provide a useful and powerful utility in our product package, *HighPoint XStore Pro*. What does XStore do? The XStore Pro is a hard disk enhancement utility which can improve system performance. The basic concept is using a read-ahead caching algorithm to improve the hard disk performance. With a market trend where most system's standard configurations are moving towards 48 MBytes memory size or beyond, HighPoint's XStore Pro provides higher system performance. XStore Pro is a new generation of XStore MMX Accelerator for Storage.

XStore Pro utilizes the bigger system memory size to enhance memory management by working with Windows® 95 and 98. XStore Pro optimizes higher system performance by read ahead caching after seeking, with large block sizes of hard disks. And best of all, XStore Pro supports several PCI Bus Master Controllers such as Intel, SiS, Ali, Via and others.

When you install XStore Pro, you can choose to install CD Xpress at the same time. Why do you need CD Xpress? We'll tell you more about it.

CD-ROM technology is growing fast, but its performance is still unacceptable compared to today's hard drives. The transfer rates of today's hard drives can exceed 18MB/sec with access times below 12ms. However, transfer rates for the fastest CD-ROM drives on the market are below 2MB/sec with access times over 100 ms.

CD Xpress was created to accelerate the accessing speed of the CD-ROM drive by utilizing the hard drive's high performance. CD Xpress reads and buffers data from the CD-ROM to an area in the hard drive. With CD Xpress, when you access CD-ROM data, you are actually accessing data from a swap file in the hard drive. This results in a tremendous increase in CD-ROM performance without penalties.

Before you install this utility, there are several things you need to know.

Important Note

1. You can only install one Bus Master Driver at a time in your system, or the drivers will result in conflict and cause system hangs. Please make sure you don't have any Bus Master Driver installed in your system before you install XStore Pro! You must remove all components of the previous Bus Master Driver before you install XStore Pro to your system. For example, you cannot install both the Intel® bus master driver and HighPoint

XStore Pro in your system, otherwise it will cause system conflict when you install the second bus master driver!

2. This Windows® 95/98 driver does not support CD-ROM Changers. If you have an ATAPI CD-ROM Changer installed in your system, please do not install this driver!
3. We have found that the Windows® 95 OSR2/Windows® 98 version would fail to load the driver on some systems using the Bus Master chipset after you install and restart the system. The following step could solve this problem if it happens:
 - (1) Go to My Computer and double click Control Panel.
 - (2) Double click System then go to Device Manger and View Devices by Type.
 - (3) Go to hard disk controllers.
 - (4) Double click PCI Bus Master IDE Controller (Ultra DMA supported). (There should be a yellow mark besides this item)
 - (5) Click Resources and you should see a box near the bottom of the screen that says "Set Configuration Manually".
 - (6) Click on "Set Configuration Manually" and you will see a check next to "Use automatic setting".
 - (7) Uncheck the box and when the system asks you to reboot click "yes".
 - (8) After the system restarts the yellow mark should be gone

4. De-Installation:

To uninstall XStore Pro from your system, run "Uninstall" from the HighPoint XStore Pro program group. This uninstall utility will: deactivate CD Xpress, if CD Xpress is active, remove the buffer space, and uninstall XStore Pro and CD Xpress from the system. After uninstalling XStore Pro, the hard disk will return to its original status. We suggest users to reboot the system after finishing uninstalling.

5. The ATAPI LS-120 device will be recognized as a removable device in retail Windows 95(4.00.95) and OSR1 Windows 95(4.00.95 A) after the XStore Pro driver is installed.
6. This driver might lock on certain motherboards. Please check HighPoint Technology first if you encounter problems.

For more detailed information, please check the read me file stored in the *XStore Pro Program Group*. If you want to upgrade to a new version of driver or want to know more about XStore Pro products, please go to the HighPoint Technologies Inc's company WEB site, the URL is <http://www.highpoint-tech.com/>.

This CD-ROM (Or floppy diskette) has the HighPoint XStore Pro drivers. (Version 1.2) The following procedure describes how to install the HighPoint XStore to your system. If you have a floppy diskette but not the CD-ROM, just insert the diskette and run the **Setup.exe** file to start installation.

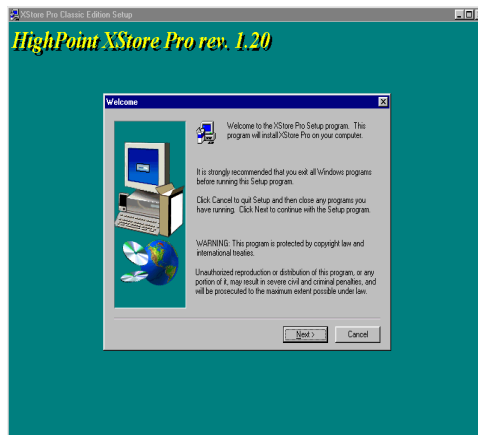

Step 1: In Windows[®] 95/98, place the CD-ROM into the computer. The main menu will show up. Click the **HighPoint XStore Pro Install** button, then you will see the XStore Pro installer is preparing the InstallShield[®] Wizard. When it is done, the *Welcome* screen will show up.

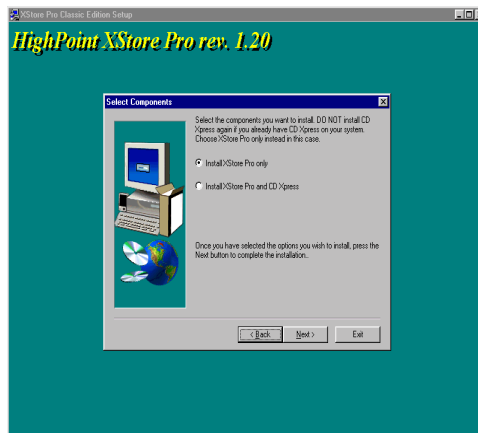

Step 2: Press the “Next” key, you will see the screen below. You then need to choose whether you want to install XStore Pro only, or if you want to install both XStore Pro and CD Xpress. Press the “Next” key to continue.

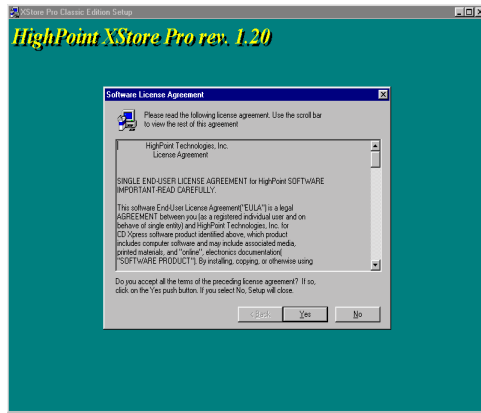

Step 3: Press the “Next” key, you will see the license screen.

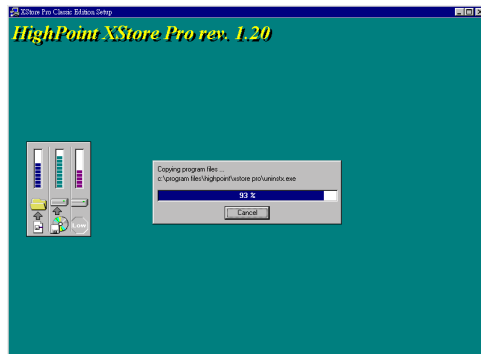

Step 4: Press “Yes” to the continue screen below.



Step 5: When installation process is done, you will see the screen below. This screen will show up only when you install both XStore Pro and CD Xpress. If you want to see the ReadMe file, you can click on the circle.

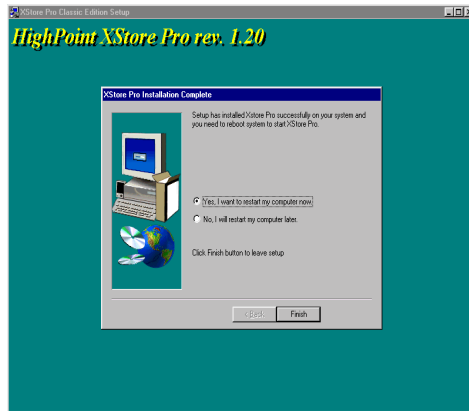

Step 6: Choose the “Yes, I want to restart my computer now.” button, then system will restart. Or you can choose the “No, I will restart my computer later.”.

Note

You must restart your computer after you installed the XStore Pro utility. Otherwise, software may works not properly.

Appendix C Hardware Monitoring Function (Installing The Winbond Hardware Doctor Utility)

Winbond Hardware Doctor is a self-diagnostic system for PCs and must be used with the Winbond chipset: W83781D/W83782D/W83783S IC series products.

It will protect PC hardware by monitoring several critical items including power supply voltages, CPU & system fan speeds, and CPU and system temperatures. These items are important for the operation of the system, errors may result in permanent damage of the PC. Once any item is out of its normal range, a warning message will pop up and remind the user to take proper measures.

The following description will tell you how to install the Hardware Doctor and use it. This CD-ROM (Or floppy diskette) has the Winbond Hardware Doctor utility. If you have a floppy diskette and not the CD-ROM, just insert diskette 1 and execute the **Setup.exe** file to start installation.

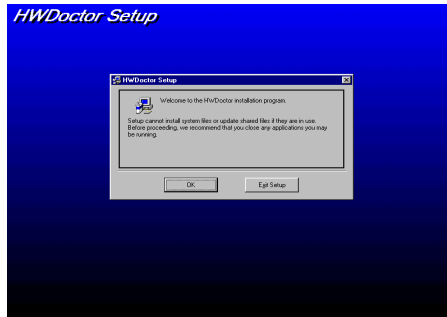

Step 1. In Windows® 95/98, place the CD-ROM into the computer. The main menu will show up. Click the **Hardware Doctor Install** button, then the *HWDoctor Setup* screen will show up, please refer the to figure below.



Step 2. Click the “OK” button, then see the screen below.

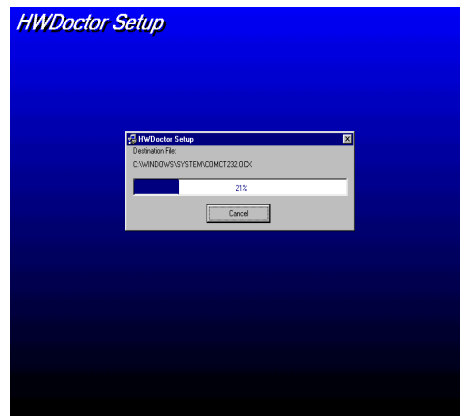

Step 3. You can specify the program install path by clicking “Change Directory” button. Or if you want to use the default path, click the  icon to continue the install process. Now the screen will show you the percentage of installation progress.



Step 4. When the progress finishes, click the “OK” button.

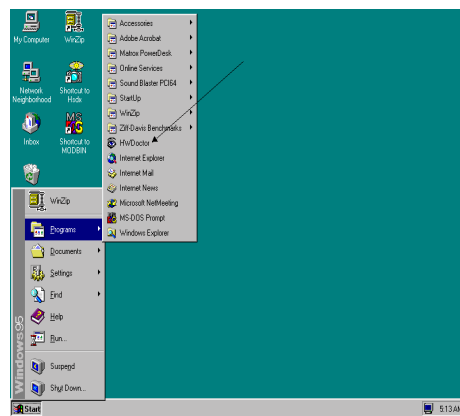

Step 5. Go to the Windows toolbar and click the “Start” button, then choose the “program” → “HWDiector” (See the arrow mark on figure below).

Once any item is out of its normal range, a warning message will pop up.

The figure below shows the warning message windows.

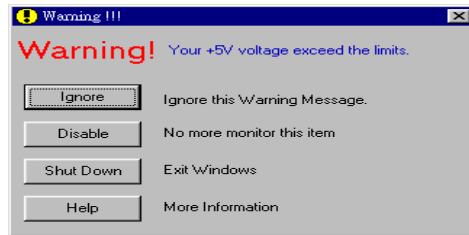

Ignore: You can ignore the warning message of the item this time, but it will still pop up when the error of the same item happens again.

Disable: The chosen item will be no longer monitored thereafter, unless you activate it in the "Configuration" page.

Shutdown: Choosing this button will shutdown the computer..

Help: You can read more information and self-diagnose simple problems.

If the warning message pops up due to the wrong warning limit, you can adjust it in the "Configuration" option. For example if you set the temperature high limit to 40°C, you are easy to exceed proper temperature.

Please pay attention to two things when you want to make any changes in the "Configuration" option. Firstly, you have to make sure your new setting is in the proper range. Secondly, after you finished the configuration, you have to save it. Otherwise, the program will start with the default value the next time.

If you meet any problems or have any questions about the software settings and adjustments, please use the Winbond hardware doctor on-line help, it should give you enough information to answer your questions.

Appendix D Troubleshooting (Need Assistance?)

If you have a problem during operation and in order to help our technical support personnel to quickly find out what the problem of your motherboard is and to give you the answers you need, before filling in the technical support form, eliminate any peripheral that is not related to the problem, and indicate on the form, the key peripherals. Fax this form to your dealer or to the company where you bought the hardware in order to benefit from our technical support. (You can refer to the examples given below)



Example 1: With a system including: motherboard (with CPU, DRAM, COAST...) HDD, CD-ROM, FDD, VGA CARD, MPEG CARD, SCSI CARD, SOUND CARD, etc. After the system is assembled, if you cannot boot up, check the key components of the system using the procedure described below. First remove all interface cards except the VGA card and try to reboot.

☛ If you still cannot boot up:

Try installing another brand/model VGA card and see if the system will start. If it still does not start, note the VGA card model, motherboard model, Bios identification number, CPU on the technical support form (refer to main instructions), and describe the problem in the problem description space provided.

☛ If you can boot up:

Insert back the interface cards you have removed one by one and try to start the system each time you insert a card, until the system doesn't start anymore. Keep the VGA card and the interface card that causes the problem inserted on the motherboard, remove any other card or peripheral, and start again. If you still cannot start, note down the information related to both cards in the add-on Card space provided, and don't forget to indicate the motherboard model, version, BIOS identification number, CPU (refer to main instructions), and give a description of the problem.



Example 2: With a system including the motherboard (with CPU, DRAM, COAST...) HDD, CD-ROM, FDD, VGA CARD, LAN CARD, MPEG CARD, SCSI CARD, SOUND CARD, after assembly and after having installed the Sound Card Driver, when you restart the system, when it runs the Sound Card Driver, it resets automatically. This problem may be due to the Sound Card Driver.

During the Starting DOS... procedure, press SHIFT (BY-PASS) key, to skip CONFIG.SYS and AUTOEXEC.BAT; edit CONFIG.SYS with a text editor, and in function the line that loads the Sound Card Driver, add a remark REM, in order to disable the Sound Card Driver. See the example below.

```
CONFIG.SYS:
DEVICE=C:\DOS\HIMEM.SYS
DEVICE=C:\DOS\EMM386.EXE HIGHSCAN
DOS=HIGH, UMB
FILES=40
BUFFERS=36
REM DEVICEHIGH=C:\PLUGPLAY\DWCFMG.SYS
LASTDRIVE=Z
```

Restart the system. If the system starts and does not reset, you can be sure that the problem is due to the Sound Card Driver. Note down the Sound Card model, motherboard model, BIOS identification number on the technical support file (refer to main instructions), and describe the problem in the space provided.

☺☺☺

Main instructions...

To fill in this “Technical Support Form”, refer to the step-by-step instructions given below:

1* . MODEL: Note the model number given in your user’s manual.

Example: ZH6, BX6, BH6, etc...

2* . Motherboard model number (REV): Note the motherboard model number labeled on the motherboard as “REV:*.*”.

Example: REV: 1.01

3* . BIOS ID and Part Number: See next page example.

ZH6

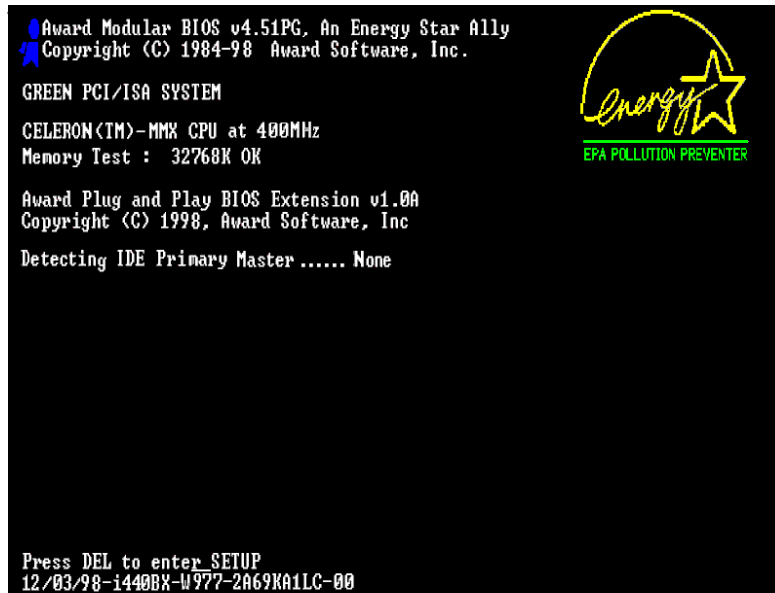

4. **DRIVER REV:** Note the driver version number indicated on the DEVICE DRIVER disk (if have) as "Release *.*". For example:

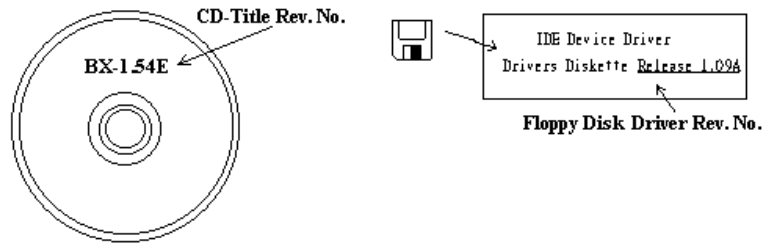

- 5*. **OS/APPLICATION:** Indicate what are the operating system and the applications your are running on the system.

Example: MS-DOS® 6.22, Windows® 95, Windows® NT...

- 6*. **CPU:** Indicate the brand and the speed (MHz) of your CPU.

Example:(A) In the “Brand” space, write “Intel”, in the “Specifications” space, write “Pentium® II MMX 300MHz”.

7. **HDD:** Indicate the brand and specifications of your HDD(s), specify if the HDD is using IDE1 or IDE2. If you know the disk capacity, indicate it and check (“✓”) “”; in case you give no indication, we will consider that your HDD is “IDE1” Master.

Example: In the “HDD” space, check the box, in the Brand space, write “Seagate”, in the Specifications space, write “ST31621A (1.6GB)”.

8. **CD-ROM Drive:** Indicate the brand and specifications of your CD-ROM drive. Specify if it uses IDE1 or IDE2 and check (“✓”) “”; in case you give no indication, we will consider that your CD-ROM is “IDE2” Master.

Example: In the “CD-ROM drive” space, check the box, in the Brand space, write “Mitsumi”, in the Specifications space, write “FX-400D”.

9. **System Memory (DRAM):** Indicate the brand and specifications (SIMM / DIMM) of your system memory. For example:

In the Brand space, write “Panasonic”, in the Specifications space, write “SIMM-FP DRAM 4MB-06”.

Or, in the Brand, write “NPNX”, in the Specifications space, write “SIMM-EDO DRAM 8MB-06”.

Or, in the Brand space, write “SEC”, in the Specifications space, write “DIMM-S DRAM 8MB-G12”.

10. **ADD-ON CARD:** Indicate which add-on cards you are *absolutely sure* are related to the problem.

If you cannot identify the problem’s origin, indicate all the add-on cards inserted into your system.

Note

Items between the “*” are absolutely necessary.

Technical Support Form

Company name:

 Phone #:

 Contact:

 Fax #:

Model	*	BIOS ID #	*
Motherboard Model No.		DRIVER REV	
OS/Application	*		
Hardware name	Brand	Specifications	
CPU	*		
HDD	<input type="checkbox"/> IDE1 <input type="checkbox"/> IDE2		
CD-ROM Drive	<input type="checkbox"/> IDE1 <input type="checkbox"/> IDE2		
System Memory (DRAM)			
ADD-ON CARD			



Problem Description:



