

PCM-3724

PC/104 48-bit Digital I/O Module



Introduction

The PCM-3724 is a PC/104-standard DIO module which attaches to the piggyback connector on your CPU card or PC/104 CPU module. The PCM-3724's two Intel 8255 PPI compatible chips provide 48 bits of parallel digital input/output. Buffered inputs and outputs offer high driving capacity.

The module's 48 bits are divided into six 8-bit I/O ports: AO, BO, CO, A1, B1 and C1. You can configure each port as either an input or output in software. The module also offers two hardware interrupt lines to the PC.

The module offers two 50-pin OPTO-22 compatible connectors which can connect to a PCLD-7216 SSR I/O module carrier board, PCLD-885 power relay output board, PCLD-785B 24/16-channel relay output board or a PCLD-782B 24/16 channel opto-isolated D/I board.

Features

- 48 TTL digital I/O lines.
- Simulates mode 0 of 8255 PPI (port CO and C1 are not separable)
- Buffer circuit for high driving capacity, TTL level
- Interrupt handling
- OPTO-22 compatible 50-pin connectors
- Output status readback

Applications

- Industrial AC/DC I/O module monitoring and control
- Relay and switch monitoring and control
- Parallel data transfer
- Sensing the signals of TTL, DTL, CMOS logic
- Driving indicator LEDs

Specifications

I/O address assignments

Address	Function
BASE+0	PORT AO
BASE+1	PORT BO
BASE+2	PORT CO
BASE+3	CFG REG
BASE+4	PORT A1
BASE+5	PORT B1
BASE+6	PORT C1
BASE+7	CFG REG
BASE+8	Direction
BASE+9	Gate control

Input signal

- Logic high voltage: 2.0 to 5.25 V
- Logic low voltage: 0.0 to 0.80 V
- High level input current: 35 mA
- Low level input current: -35 mA

Output signal

- Logic high voltage: 2.4 V min.
- Logic low voltage: 0.4 V max.
- High level output current: -35 mA max.
- Low level output current: 35mA max.
- Driving capacity: 15 LS TTL

Transfer rate

- Typical: 300 K bytes/sec
- Maximum: 500 K bytes/sec

General

- Power consumption: +5 V @ 60 mA typical
+5 V @ 170 mA max
- Operating temperature: 0 ~ +60° C (32 ~ 140° F)
- Storage temperature: -20 ~ +70° C (-4 ~ 158° F)
- Operating humidity: 5 ~ 95% RH non-cond.
(refer to IEC 68-2-3)
- Connector: Two OPTO-22 compatible 50-pin connectors (J3 and J4)

Connector pin assignments

J3/port 1

PC 07	1	2	GND
PC 06	3	4	GND
PC 05	5	6	GND
PC 04	7	8	GND
PC 03	9	10	GND
PC 02	11	12	GND
PC 01	13	14	GND
PC 00	15	16	GND
PB 07	17	18	GND
PB 06	19	20	GND
PB 05	21	22	GND
PB 04	23	24	GND
PB 03	25	26	GND
PB 02	27	28	GND
PB 01	29	30	GND
PB 00	31	32	GND
PA 07	33	34	GND
PA 06	35	36	GND
PA 05	37	38	GND
PA 04	39	40	GND
PA 03	41	42	GND
PA 02	43	44	GND
PA 01	45	46	GND
PA 00	47	48	GND
+5 V	49	50	GND

J4/port 2

PC 17	1	2	GND
PC 16	3	4	GND
PC 15	5	6	GND
PC 14	7	8	GND
PC 13	9	10	GND
PC 12	11	12	GND
PC 11	13	14	GND
PC 10	15	16	GND
PB 17	17	18	GND
PB 16	19	20	GND
PB 15	21	22	GND
PB 14	23	24	GND
PB 13	25	26	GND
PB 12	27	28	GND
PB 11	29	30	GND
PB 10	31	32	GND
PA 17	33	34	GND
PA 16	35	36	GND
PA 15	37	38	GND
PA 14	39	40	GND
PA 13	41	42	GND
PA 12	43	44	GND
PA 11	45	46	GND
PA 10	47	48	GND
+5 V	49	50	GND

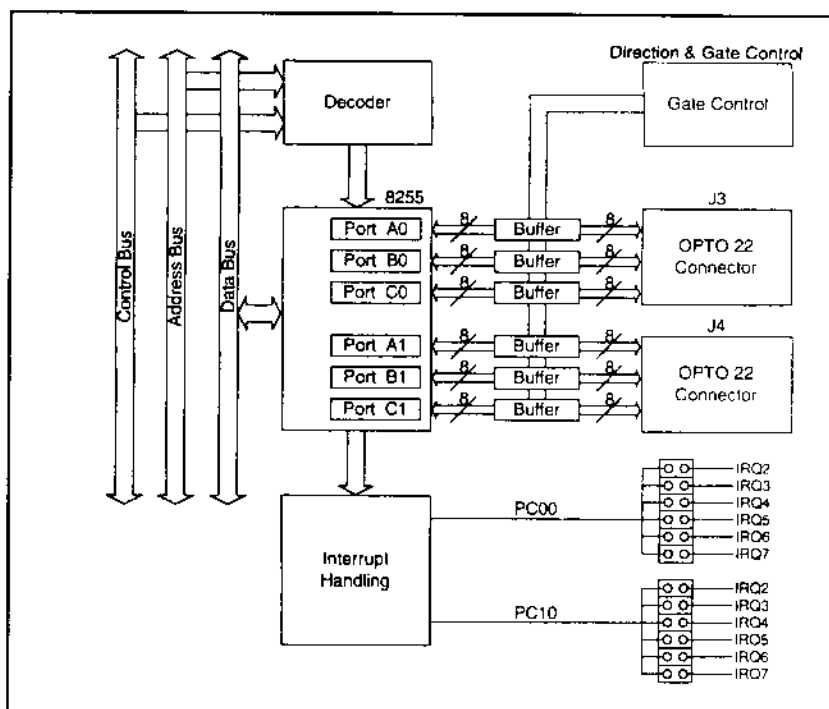

PCM-3724 Block Diagram

Installation

Initial inspection

Before you install the PCM-3724, first check to make sure it was not damaged during shipping. If you find any damage or the module fails to meet specifications, please contact your local dealer or sales representative. Also contact the shipper and save the shipping materials for the shipper's inspection.

Switch and jumper settings

We designed the PCM-3724 with ease-of-use in mind. It has one function switch and six jumper settings. The following sections tell how to configure the module. You may want to refer to the figure below for help identifying module components.

CAUTION! Do not install or remove the PCM-3724 I/O board while the power is ON, as this may damage the plug-in board or CPU card.

The following diagram shows the location of the module's switches and jumpers:

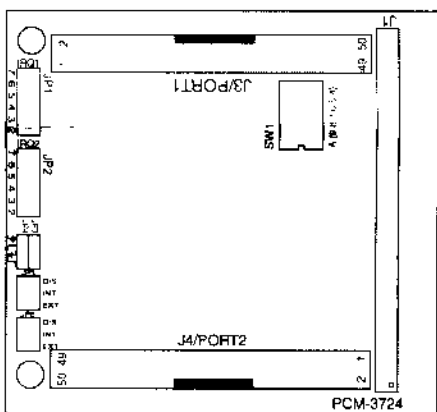

Jumper and switch locations

Base address selection (SW1)

You control the PCM-3724's operation by reading or writing data to the PC's I/O (input/output) port addresses. The module requires 16 consecutive address locations. Switch SW1 sets the module's base (beginning) address. Valid base addresses range from Hex 000 to Hex 3F0. Other devices in your system may, however, be using some of these addresses.

We set the PCM-3724 for a base address of Hex 300 at the factory. If you need to adjust it to some other address range, set switch SW1 as shown below:

Module I/O addresses (SW1)

Range (hex)	Switch position				
	1	2	3	4	5
000 - 00F	•	•	•	•	•
010 - 01F	•	•	•	•	•
...					
200 - 20F	○	•	•	•	•
210 - 21F	○	•	•	•	•
...					
300 - 30F	○	○	•	•	•
...					
3F0 - 3FF	○	○	○	○	○

○ = Off • = On * = default

Switches 1-6 control the PC bus address line follows:

Switch	1	2	3	4	5	6
Line	A9	A8	A7	A6	A5	A4

Interrupt settings (JP1, JP2)

Jumpers JP1 and JP2 control the IRQ levels, as below:

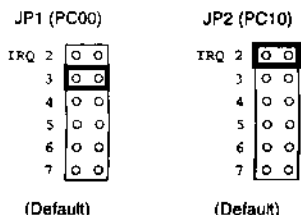

Note: You must set each I/O line to a valid interrupt level.

Interrupt level (JP3, JP4)

Jumpers JP3 and JP4 select the trigger edge (rising or falling) for I/O lines PC00 and PC10, respectively. Settings appear below:

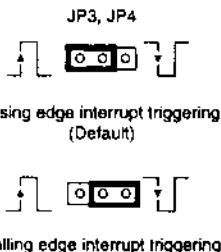

If you set the PCL-3724 to trap on a rising edge, the module will generate an interrupt if the I/O line (PC00 or PC10) changes from TTL LOW to TTL HIGH. Conversely, if you set the module to trap on a falling edge change, then it will generate an interrupt when the I/O line changes from TTL HIGH to TTL LOW.

Interrupt mode (JP5, JP6)

The PCM-3724 provides two I/O lines (PC00 and PC10) which you can use to generate hardware interrupts to the PC. Jumper JP5 controls interrupt line PC00, and jumper JP6 controls interrupt line PC10. The DIS setting for each jumper (shown in the figure below) disables the corresponding line's interrupt capability. The INT setting enables the line's interrupt capability.

JP5 and JP6



(Default)

The EXT setting allows you to enable and disable control by external interrupt. I/O line PC04 controls the interrupt on line PC00, and line PC14 controls the interrupt on line PC10. Bring line PC04 to TTL LOW to enable the interrupt capability on PC00. Send line PC04 to TTL HIGH to disable the interrupt capability on PC00. I/O line PC14 controls PC10 in the same way.

Operation

The PCM-3724 module simulates MODE 0 8255 programmable peripheral interface (PPI) Port C undividable. The module is pin compatible with most industrial solid state I/O racks and such as those manufactured by OPTO-22, Brumfield, Gordos, etc.

The PCM-3724's two 50-pin male IDC connector interface with directly to OPTO-22 racks.

The PCM-3724 offers two I/O lines (PC00 and PC10) which generate hardware interrupts, as described c

Configuration

Mode 0 of the 8255 provides simple input/output functions. No handshaking is required since you can read or write data directly to or from a specified p

8255 MODE 0 function definition

- Six 8-bit ports (Port A0, B0, C0, A1, B1 and C1)
- Any port can be used for input or output
- Outputs are latched, whereas inputs are not latched

The PCM-3724 requires ten I/O ports, identified

I/O port assignments

Location	Write	Read
BASE+0	8255 Port A0	8255
BASE+1	8255 Port B0	8255
BASE+2	8255 Port C0	8255
BASE+3	8255 Mode Register for Ports A0, B0 and C0	N/A
BASE+4	8255 Port A1	8255
BASE+5	8255 Port B1	8255
BASE+6	8255 Port C1	8255
BASE+7	8255 mode Register for Ports A1, B1 and C1	N/A
BASE+8	DIO direction	N/A
BASE+9	Gate control	N/A

8255 data registers

The PCM-3724's I/O ports (BASE+0 to 2 and to 6) directly map to the 8255 ports. Bit assignments for each I/O port appear below:

BASE+0 8255 Port A0 (read/write)							
Bit	7	6	5	4	3	2	1
Value	PA07	PA06	PA05	PA04	PA03	PA02	PA01

BASE+1 8255 Port B0 (read/write)							
Bit	7	6	5	4	3	2	1
Value	PB07	PB06	PB05	PB04	PB03	PB02	PB01

BASE+2 8255 Port C0 (read/write)							
Bit	7	6	5	4	3	2	1
Value	PC07	PC06	PC05	PC04	PC03	PC02	PC01

If you set the PCL-3724 to trap on a rising edge, the module will generate an interrupt if the I/O line (PC00 or PC10) changes from TTL LOW to TTL HIGH. Conversely, if you set the module to trap on a falling edge change, then it will generate an interrupt when the I/O line changes from TTL HIGH to TTL LOW.

Interrupt mode (JP5, JP6)

The PCM-3724 provides two I/O lines (PC00 and PC10) which you can use to generate hardware interrupts to the PC. Jumper JP5 controls interrupt line PC00, and jumper JP6 controls interrupt line PC10. The DIS setting for each jumper (shown in the figure below) disables the corresponding line's interrupt capability. The INT setting enables the line's interrupt capability.

JP5 and JP6



(Default)

The EXT setting allows you to enable and disable control by external interrupt. I/O line PC04 controls the interrupt on line PC00, and line PC14 controls the interrupt on line PC10. Bring line PC04 to TTL LOW to enable the interrupt capability on PC00. Send line PC04 to TTL HIGH to disable the interrupt capability on PC00. I/O line PC14 controls PC10 in the same way.

Operation

The PCM-3724 module simulates MODE 0 8255 programmable peripheral interface (PPI) Port C undividable. The module is pin compatible with most industrial solid state I/O racks and such as those manufactured by OPTO-22, Brumfield, Gordos, etc.

The PCM-3724's two 50-pin male IDC connector interface with directly to OPTO-22 racks.

The PCM-3724 offers two I/O lines (PC00 and PC10) which generate hardware interrupts, as described below.

Configuration

Mode 0 of the 8255 provides simple input/output functions. No handshaking is required since you can read or write data directly to or from a specified port.

8255 MODE 0 function definition

- Six 8-bit ports (Port A0, B0, C0, A1, B1 and C1)
- Any port can be used for input or output
- Outputs are latched, whereas inputs are not latched

The PCM-3724 requires ten I/O ports, identified below.

I/O port assignments

Location	Write	Read
BASE+0	8255 Port A0	8255
BASE+1	8255 Port B0	8255
BASE+2	8255 Port C0	8255
BASE+3	8255 Mode Register for Ports A0, B0 and C0	N/A
BASE+4	8255 Port A1	8255
BASE+5	8255 Port B1	8255
BASE+6	8255 Port C1	8255
BASE+7	8255 mode Register for Ports A1, B1 and C1	N/A
BASE+8	DIO direction	N/A
BASE+9	Gate control	N/A

8255 data registers

The PCM-3724's I/O ports (BASE+0 to 2 and to 6) directly map to the 8255 ports. Bit assignments for each I/O port appear below:

BASE+0 8255 Port A0 (read/write)							
Bit	7	6	5	4	3	2	1
Value	PA07	PA06	PA05	PA04	PA03	PA02	PA01

BASE+1 8255 Port B0 (read/write)							
Bit	7	6	5	4	3	2	1
Value	PB07	PB06	PB05	PB04	PB03	PB02	PB01

BASE+2 8255 Port C0 (read/write)							
Bit	7	6	5	4	3	2	1
Value	PC07	PC06	PC05	PC04	PC03	PC02	PC01

BASE+4 8255 Port A1 (read/write)								
Bit	7	6	5	4	3	2	1	0
Value	PA17	PA16	PA15	PA14	PA13	PA12	PA11	PA10

BASE+5 8255 Port B1 (read/write)								
Bit	7	6	5	4	3	2	1	0
Value	PB17	PB16	PB15	PB14	PB13	PB12	PB11	PB10

BASE+6 8255 Port C1 (read/write)								
Bit	7	6	5	4	3	2	1	0
Value	PC17	PC16	PC15	PC14	PC13	PC12	PC11	PC10

8255 mode registers

BASE+3 8255 Mode Register, A0, B0, C0 (write)								
Bit	7	6	5	4	3	2	1	0
Value	1	0	0	PA0	PC0	0	PB0	PC0

Where:

- PB0: 0 = Port B0 as output
1 = Port B0 as input
- PC0: 0 = Port C0 as output
1 = Port C0 as input
- PA0: 0 = Port A0 as output
1 = Port A0 as input

BASE+7 8255 Mode Register, A1, B1, C1 (write)								
Bit	7	6	5	4	3	2	1	0
Value	1	0	0	PA1	PC1	0	PB1	PC1

Where:

- PB1: 0 = Port B1 as output
1 = Port B1 as input
- PC1: 0 = Port C1 as output
1 = Port C1 as input
- PA1: 0 = Port A1 as output
1 = Port A1 as input

- NOTE:**
- After power-on or reset, all ports (Port A0, B0, C0, A1, B1 and C1) are set to input mode.
 - Using the TTL74245 chip as on-board buffer to enhance the driving capacity of digital output channels will have only Mode 1 enabled on the programmable peripheral interface, 82C55A.
 - In order to satisfy customer's needs to enable all modes on 82C55A, it is advised that you replace each TTL74245 chip with two 8P4R 0x1 net resistors. This functional flexibility is made possible through a conscientious design that foresees customer's need. You are welcome to ask us about tailoring our standard products to meet your specifications.
 - Driving capacity after replacement with 8P4R 0x1 net resistors:

* High level output current: -2.5 mA

* Low level output current: 2.5 mA

* Driving capacity: 1 LS TTL

- For detailed information of 82C55A please access the following path CD-ROM: \Document\Intersil\82C55A manual.pdf

Gate control

Six 74HCT245 chips (one for each port) buffer PCM-3724's I/O lines to increase driving capacity. Because the 74HCT245 is a bidirectional, tri-state buffer, you need to set two additional I/O ports (B and 9) to control the direction of data flow.

The following diagrams show the gate and direction signals for each port:

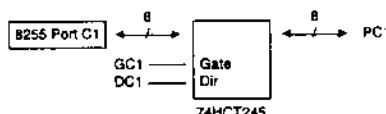
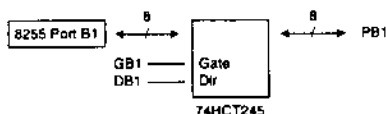
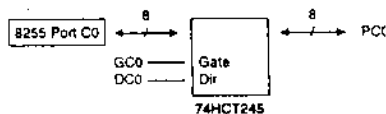
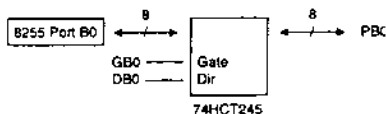
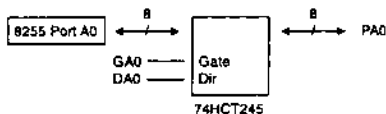

Gate and direction assignments for each port

Address assignments for the buffer direction register (BASE+8) and gate control register (BASE+9) are as follows:

BASE+8 Buffer direction (write)								
Bit	7	6	5	4	3	2	1	0
Value	N/A	N/A	DA1	DB1	DC1	DAP	DB0	

Where:

DA0	1 = Port A0 is an output port 0 = Port A0 is an input port
DB0	1 = Port B0 is an output port 0 = Port B0 is an input port
DC0	1 = Port C0 is an output port 0 = Port C0 is an input port
DA1	1 = Port A1 is an output port 0 = Port A1 is an input port
DB1	1 = Port B1 is an output port 0 = Port B1 is an input port
DC1	1 = Port C1 is an output port 0 = Port C1 is an input port

BASE+9 Gateactive/tri-state (write)

Bit	7	6	5	4	3	2	1	0
Value	N/A	N/A	GA1	GB1	GC1	GAP	GB0	GC0

Where:

GA0	0 = Port A0 remains tri-state 1 = Port A0 becomes active
GB0	0 = Port B0 remains tri-state 1 = Port B0 becomes active
GC0	0 = Port C0 remains tri-state 1 = Port C0 becomes active
GA1	0 = Port A1 remains tri-state 1 = Port A1 becomes active
GB1	0 = Port B1 remains tri-state 1 = Port B1 becomes active
GC1	0 = Port C1 remains tri-state 1 = Port C1 becomes active

NOTE: System power-on or reset will clear registers BASE+8 and 9, setting all ports to gated-off (tri-state) and input data direction.

Interrupt handling

The PCM-3724 offers two I/O lines, PC00 and PC10, which you can use to generate a hardware interrupt to the CPU. Interrupts are edge-triggered. Please refer to page 3 for jumper settings and description.

NOTE: Since the PCM-3724's digital input data are not latched, the module provides no "first event" trapping to determine which input was active first.

Although interrupts are normally triggered by external signals, the PCM-3724 can send output data to emulate an interrupt signal. See the example programs in the following section.

Programming

The following programming examples show how the module's readback function to monitor tri-state status, how to use the interrupt function (rising falling edge) and how to set the initial value output port. The example programs run under version 2.0 or later.

Programming notes

You can program the PCM-3724's ports in soft input, output or tri-state. When you power-on your system, however, all of the ports will be tri-state. When you configure one of the ports for output for the first time and send data to it, it will be in output until you have set the output buffer and activated the gate. This prevents external devices from being damaged before they are initialized. When the port is set for output, a read action on the port will return the data to be output.

```

.....
* This demo program shows how to use the PCM-3724's
* readback function to monitor the output status.
* Hardware settings:
* 1. Base address set at 0x300
.....
#include <stdio.h>
#include <conio.h>
#include <sysregs.h>
#include <dos.h>

main ()
{
int base = 0x300; /* set base address to 0x300 */
/*
int portA; /* save readback value of port A */
int portB; /* save readback value of port B */
int portC; /* save readback value of port C */
int i, j;

/* handle screen */
clear ();
gotoxy ( 37, 3 );
textattr ( 0x7C );
cpuinfo ( "PCM-3724 DEMO PROGRAM" );
gotoxy ( 11, 6 );
printf ( "PortA0 output value -> " );
gotoxy ( 11, 6 );
printf ( "PortB0 output value -> " );
gotoxy ( 11, 10 );
printf ( "PortC0 output value -> " );
gotoxy ( 41, 6 );
printf ( "PortA1 Readback -> " );
gotoxy ( 41, 6 );
printf ( "PortB1 Readback -> " );
gotoxy ( 41, 10 );
printf ( "PortC1 Readback -> " );

/* initialization */
outporth (base+0,0x0); /* disable all gates */
outporth (base+1,0x80); /* set B25F portC all 1's */
outporth (base+8,0xff); /* set direction of all ports */
outporth (base+9,0xff); /* enable all gates */
.....
for ( j=0; j<0x100; j++) main program ****
{
outporth (base, j); /* out j to port A0 */
go (xy ( 14, 6 );
printf ("%2x", j);
portA = inporth (base);
go (xy ( 43, 6 );
printf ( "%2x", portA );
if ( portA != j )
printf ( "%7s", "beep " );
gotoxy ( 30, 13 );
textattr ( 0x00 );
cpuinfo ( "PortA1 readback error!!" );
getch ();
exit ( 1 ); /* quit to dos */
}
outporth (base+1, j); /* out j to port B0 */
gotoxy ( 14, 7 );
printf ("%2x", j);
portB = inporth (base+1);
}

```

```

gotoxy(63,8);
printf("\2x",portB);
if ( portB != j )
{
    printf ("V7"); /* beep */
    gotoxy (10,11);
    textattr (0x09);
    cprintf("PortB readback error!");
    getch ();
    exit(1); /* quit to dos */
}
outpwrh (base+2, j); /* set j to port C */
gotoxy (14,10);
printf ("2x",j);
portC = inpwrh (base+2);
gotoxy (63,10);
printf ("2x", portC);
if ( portC != j )
{
    printf ("V7"); /* beep */
    gotoxy (10,13);
    textattr (0x09);
    cprintf("PortC readback error!");
    getch ();
    exit(1); /* quit to dos */
}
} /* end of for */
} /* end of main */

```

```

.....
* This demo program shows how to use the interrupt
* function (rising edge) of the PCMC-3724.
* Hardware settings:
* 1. Base address set at 0x100
* 2. JP1 set at IRQ 2
* 3. JP5 set at INT or EXT
* 4. JP3 set at RISING trigger
.....
#include <dos.h>
#include <stdio.h>
#include <conio.h>

/* new INT 0Ah ISR */
void interrupt alarm (void)
{
    char Port61_Old_Status;
    char Port61_New_Status;
    int DelayTime = 0x350;
    int Count = 0;
    int i;

    /* get original port 61H status and save it */
    Port61_New_Status=Port61_Old_Status=inpwrh (0x61);
    /* set port 61h bit 1 to 0 */
    Port61_New_Status ^= 0x02; /* 1111 1101 in binary */
    for (Count=0;Count<0x100;Count++, DelayTime--)
    {
        Port61_New_Status ^= 0x02; /* ON/OFF bit */
        outpwrh (0x61, Port61_New_Status);
        for (i=0; i<DelayTime;i++)
        {
        }
        outpwrh (0x61, Port61_Old_Status);
        outpwrh (0x20, 0x20); /* send EOI to 8259 */
    } /* end of ISR */
}

void main ()
{
    int IMR,base=0x100;
    void interrupt (*Int_A_Old_Vector) ();
    int A_Old_Vector = getvect (0x0A); /* get old int 0Ah ISR */
    setvect (0x0A,alarm); /* set new int 0Ah ISR */
    IMR = inpwrh(0x21); /* get 8259 interrupt mask register */

    /* initialization */
    outpwrh (base+9,0x0); /* disable all gates */
    outpwrh (base+3,0x0); /* set Port A0, B0 and C0 to */
    /* output mode */
    outpwrh (base+8,0x0); /* set all ports to output direction */
    outpwrh (base+9, 0x0f); /* enable all gates */
    clrscr();
    printf ("Press any key to generate a rising edge"
    " interrupt");
    getch ();
    outpwrh(0x21,0x2f & IMR); /* set IRQ2 nonmasked */
    /* PC04=0->interrupt enable, set PC02=0 and then set
    PC05 = 1 to generate a rising edge signal */
    outpwrh (base+2, 0x0);
    printf ("\n\nPort C0 = %x", inpwrh (0x2c2));
}

/* generate a rising edge signal PC00 */
outpwrh (base+2,0x01); /* set PC04 = 0 > inter
enable, set PC05 = 1 */
printf ("\n\nPort C0 = %x",inpwrh(0x2c2));
printf ("\n\nPress any key to quit...");
getch ();

/* restore old INT 0Ah ISR */
setvect (0x0A, Int_A_Old_Vector);
outpwrh (0x21, IMR);
}

```

```

.....
* This demo program shows how to use the interrupt
* function (falling edge) of the PCMC-3724.
* Hardware settings:
* 1. Base address set at 0x100
* 2. JP1 set at IRQ 2
* 3. JP5 set at INT or EXT
* 4. JP3 set at FALLING trigger
.....
#include <dos.h>
#include <stdio.h>
#include <conio.h>

/* new INT 0Ah ISR */
void interrupt alarm (void)
{
    char Port61_Old_Status;
    char Port61_New_Status;
    int DelayTime = 0x100;
    int Count = 0;
    int i;

    /* get original port 61H status and save
    Port61_New_Status=Port61_Old_Status=inpwrh(0x61);
    /* set port 61h bit 1 to 0 */
    Port61_New_Status ^= 0x02; /* 1111 1101 in b
    i=0; i<Count; i++, Count--, DelayTime--);
    Port61_New_Status ^= 0x02; /* ON/OFF bit */
    outpwrh (0x61, Port61_New_Status);
    for (i=0; i<DelayTime;i++)
    {
    }
    outpwrh (0x61, Port61_Old_Status);
    outpwrh (0x20,0x20); /* send EOI to 8259 */
} /* end of ISR */

void main ()
{
    int IMR,base=0x100;
    void interrupt (*Int_A_Old_Vector) ();
    /* get old int 0Ah ISR */
    int A_Old_Vector = getvect(0x0A);
    setvect (0x0A,alarm); /* set new int 0Ah I
    /* get 8259 interrupt mask register */
    IMR = inpwrh(0x21);

    /* initialization */
    outpwrh (base+9,0x0); /* disable all gat
    outpwrh (base+3,0x0); /* set Port A0, B0 a
    /* to output mode */
    outpwrh (base+8,0x0); /* set all ports to output direction */
    outpwrh (base+9, 0x0f); /* enable all gat
    clrscr ();
    printf ("\n\nPress any key to generate a fallin
    " interrupt");
    getch();
    outpwrh(0x21,0x2f & IMR); /* set IRQ2 nonm
    /* PC04=0 -> interrupt enable, set PC05=1, t
    PC00=0 to generate a falling edge signal */
    outpwrh (base+2,0x01);
    printf ("\n\nPort C0 = %x",inpwrh(0x2c2));

    /* generate a falling edge signal PC00 */
    /* PC04=0 -> interrupt enable, set PC05=0
    outpwrh (base+2, 0x00);
    printf ("\n\nPort C0 = %x",inpwrh(0x2c2));
    printf ("\n\nPress any key to quit...");
    getch ();

    /* restore old INT 0Ah ISR */
    setvect (0x0A, Int_A_Old_Vector);
    /* restore 8259 interrupt mask */
    outpwrh (0x21, IMR);
}

```



```

/* set as INPUT to release IRQ2 line */
outpwrth (base+3, 0x9b);
outpwrth(base+9, 0x0); /* disable all gates */
/* set all ports to input direction */
outpwrth (base+8, 0x0);
outpwrth (base+9, 0xff); /* enable all gates */
} /* end of main() */

.....

* This demo program demonstrates how to set the
* PCN 3724's output port to an initial value.
*
* Hardware settings:
* 1. Base address set at 0x300
*
*.....

#include <stdio.h>
#include <conio.h>
#include <process.h>
#include <dos.h>

main()
{
    int base = 0x300; /* set base address to 300 (hex) */

    /* handle screen */
    clrscr();
    gotoxy(10, 1);
    textattr(0x70);
    output("PCN-3724 DEMO PROGRAM");
    gotoxy(27, 6);
    printf("portA0 output value -> %H");
    getch(27, 8);
    printf("portB0 output value -> %H");
    getch(27, 10);
    printf("portC0 output value -> %H");

    * * * * * main program * * * * *
    /* Initialization */
    outpwrth (base+9, 0x0); /* disable all gates */
    outpwrth (base+3, 0x0); /* set 6255 port 0 all as */
    /* output */

    outpwrth (base, 0xff); /* out fH to port A0 */
    outpwrth (base+1, 0x0); /* out 0H to port B0 */
    outpwrth (base+2, 0xff); /* out fH to port C0 */
    outpwrth (base+8, 0xff); /* set direction to
    output */

    /* for All ports */
    outpwrth (base+3, 0xff); /* enable all gates */
} /* end of main() */

```

警告使用書

這是琳琳的資訊產品，在居住的環境中，
可能會造成射頻干擾，在這種情況下，
被要求採取某些適當的對策。