

AI5VG
Pentium VP3 Baby AT Motherboard
User's Manual
Version 2.0

Contents

Chapter 1 Introduction.....	1
Chapter 2 Specifications	2
Chapter 3 Hardware Description	4
3.1 Processor and CPU Voltage	6
3.2 L2 Cache Memory	6
3.3 Main Memory	6
3.4 BIOS	8
3.5 Onboard PCI EIDE.....	9
3.6 Onboard Multi-I/O.....	9
3.7 Onboard CPU Temperature Sensor	9
3.8 I/O Port Address Map.....	10
3.9 DMA Channels	10
3.10 Interrupt Request Lines (IRQ).....	11
3.11 Accelerated Graphics Port (AGP) Slot.....	11
Chapter 4 Hardware Settings.....	12
4.1 SW1(1-8): CPU Frequency Selector	14
4.2 SW2(1-4): CPU Voltage Selector	16
4.3 JP5: Clear CMOS Selection	18
Chapter 5 Installation	19
5.1 I/O Connectors.....	21
5.2 J3: AT Power Supply Connector.....	21
5.3 J2: ATX Power Supply Connector	22
5.4 J1, J4: AT Keyboard and PS/2 Mouse Connectors	22
5.5 J7, J6: Serial Ports	23
5.6 J8: Floppy Drive Connector	23
5.7 J9, J11: EIDE Connectors.....	24
5.8 J10: Parallel Port Connector.....	25
5.9 J15: IrDA Connector	25
5.10 J5: USB Connector	25
5.11 J13 Wake on LAN Connector	26
5.12 J14: CPU Fan Power Connector.....	26
5.13 J20 Front Bezel Connector	26

Chapter 6 BIOS Configuration.....	29
6.1 BIOS Introduction	32
6.2 BIOS Setup	32
6.3 Standard CMOS Setup.....	34
6.4 BIOS Features Setup	37
6.5 Chipset Features Setup	40
6.6 Power Management Setup	42
6.7 PNP/PCI Configuration	45
6.8 Load BIOS Defaults	48
6.9 Load Setup Defaults	48
6.10 Integrated Peripherals	49
6.11 Supervisor / User Password.....	51
6.12 IDE HDD Auto Detection	52
6.13 HDD Low Level Format.....	52
6.14 Save & Exit Setup.....	53
6.15 Exit Without Saving	53

Chapter 1 Introduction

This manual is designed to give you information on the AI5VG Motherboard. It is divided into the following six sections:

- **Introduction**
- **Specifications**
- **Hardware Description**
- **Hardware Settings**
- **Installation**
- **BIOS Configuration**

Checklist

Please check that your package is complete and contains the items below. If you discover damaged or missing items, please contact your dealer.

- ✧ **The AI5VG Motherboard**
- ✧ **This user's manual**
- ✧ **1 IDE ribbon cable**
- ✧ **1 floppy ribbon cable**
- ✧ **2 serial ribbon cables***
- ✧ **1 parallel ribbon cable**
- ✧ **1 PS/2 cable**
- ✧ **1 diskette containing Bus Master IDE drivers and and flash utility**
- ✧ **1 diskette containing VxD drivers**

* Use the two serial ribbon cables provided to avoid compatibility problems.

Chapter 2 Specifications

Based on VIA's VP3AT chipset, the AI5VG is a Baby AT Pentium motherboard that supports all the features to make a Microsoft PC'97 compliant PCI/ISA system. This high performance model comes with an Accelerated Graphics Port (AGP) slot, power management functionality that is compliant with ACPI (Advanced Configuration and Power Interface) and legacy APM requirements. In addition to standard PIO and DMA mode operation, the AI5VG features Ultra DMA/33 for improved disk I/O throughput. The main features of this motherboard are listed as follows:

Main Processor

Intel Pentium 90/100/120/133/150/166/200
Intel Pentium MMX (P55C) 90/100/120/133/150/166/200/233
Cyrix 6x86/6x86L P150+/P166+/P200+
Cyrix 6x86MX PR166/PR200/PR233/PR266
AMD K5 PR100/PR133/PR166
AMD K6 166/200/233

L2 Cache

512KB Pipelined Burst Synchronous SRAM onboard

Main Memory

Four 72-pin SIMM sockets and two 168-pin DIMM sockets

Memory Type

SIMMs: FPM (Fast Page Mode) or EDO (Extended Data Out)

SIMM Size: 4MB 8MB 16MB 32MB 64MB

DIMMs: EDO DRAM or SDRAM (Synchronous DRAM)

DIMM Size: 8MB 16MB 32MB 64MB 128MB

Chipset

VIA's VP3AT chipset with built-in PCI EIDE

Onboard I/O

Winbond W83877 for two serial, one parallel, one floppy drive interface and IrDA support

Onboard Bus Mastering EIDE

Two EIDE interfaces for up to four devices, support PIO Mode 3/4 or Ultra DMA/33 IDE Hard Disk and ATAPI CD-ROM.

BIOS

Licensed BIOS with additional features:

- FLASH EEPROM (128KB) for BIOS update
- ISA Plug and Play (PnP) extension
- Power management

CPU Temperature Sensor

The AD22105 IC on the motherboard is a temperature sensor for the CPU. When the CPU temperature exceeds threshold value, the CPU slows down automatically to allow it to cool down to a safe level.

Windows 95 Shut-Down

This allows the PC to power off via Windows 95 operating system. (This feature requires ATX power supply.)

AGP Support (Accelerated Graphics Port)

The AI5VG motherboard comes with an AGP slot for an AGP VGA card that supports 133MHz 2X mode for AD and SBA signaling.

PC97 Compliance

The AI5VG implements BIOS and hardware designs that meet PC97 standards and is fully compatible with all Windows operating systems.

Expansion Slots

Four 32-bit PCI slots
Two 16-bit ISA slots
One AGP slot

Form Factor

Baby AT, 9"x8.6" (23cm x 22cm)

Chapter 3 Hardware Description

This chapter briefly describes each of the major features of the AI5VG motherboard. The layout of the board is shown in Figure 1 which shows the locations of the key components. The topics covered in this chapter are as follows:

3.1 Processor and CPU Voltage.....	6
3.2 L2 Cache Memory	6
3.3 Main Memory	6
3.4 BIOS	8
3.5 Onboard PCI EIDE.....	9
3.6 Onboard Multi-I/O.....	9
3.7 Onboard CPU Temperature Sensor	9
3.8 I/O Port Address Map.....	10
3.9 DMA Channels	10
3.10 Interrupt Request Lines (IRQ)	11
3.11 Accelerated Graphics Port (AGP) Slot	11

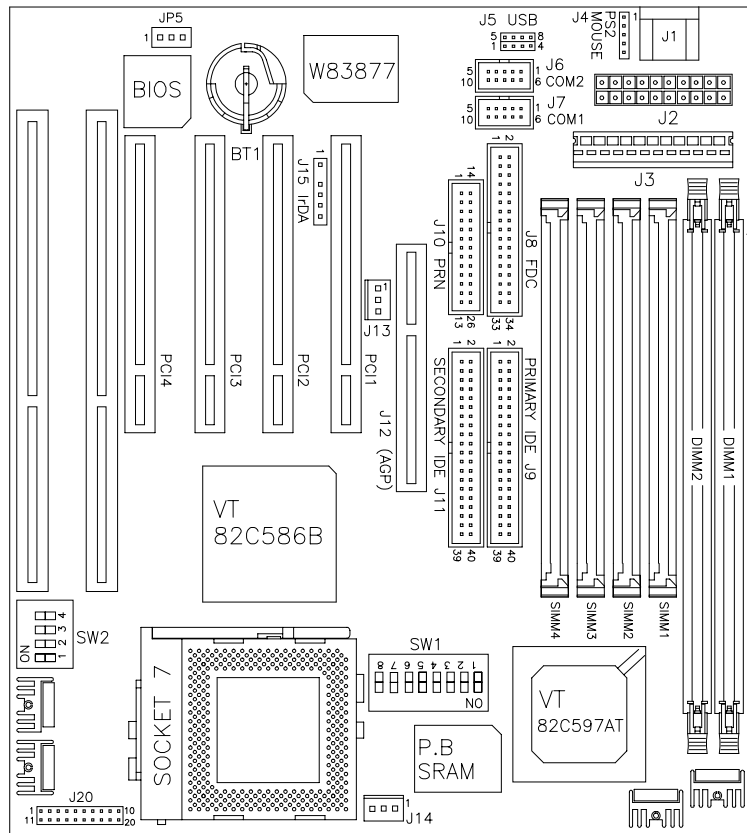

Figure 1: Layout of the AI5VG Motherboard

3.1 Processor and CPU Voltage

The AI5VG is designed to take a Pentium Processor with a bus speed of 60 and 66 MHz. The internal clock of the CPU can be multiples of 1.5, 2, 2.5, 3, 3.5, 4 and 4.5 of the bus clock, the CPU frequency can be 90 to 300MHz.

The onboard CPU voltage regulator provides support for CPUs Vcore which require voltage other than 3.3V such as 2.8V, and/or power consumption higher than 10 watts.

3.2 L2 Cache Memory

The AI5VG supports 512KB P.B. (Pipelined Burst) Synchronous Cache. The P.B. Synchronous Cache boosts the system's performance, 10% higher than regular Asynchronous Cache.

3.3 Main Memory

The AI5VG motherboard supports four 72-pin SIMMs and two 168-pin DIMMs (Dual In-line Memory Module) sockets. The DRAMs for the SIMM sockets can be 4MB, 8MB, 16MB, 32MB, and 64MB in EDO and FPM types. DIMM modules can be 8MB, 16MB, 32MB, 64MB and 128MB in EDO DRAM or SDRAM type.

The following should be noted when populating the SIMM/DIMM sockets:

1. SIMM1/SIMM2, SIMM3/SIMM4 or DIMM1, DIMM2 bank can be populated first.
2. Each bank** should consist of the same size SIMMs.
3. Each bank should consist of the same type SIMMs. For example, *SIMM1 and SIMM2 are both be EDO or Page Mode.*

** *Each bank consists of two SIMM slots or one DIMM slot. For example, SIMM 1 and SIMM 2 are considered as one bank and DIMM 1 as another one.*

(1) 72-pin SIMM (5V)

EDO DRAM

Bank0 (SIMM1, SIMM2)	Bank1 (SIMM3, SIMM4)	Total Memory
4MB×2	-----	8MB
8MB×2	-----	16MB
16MB×2	-----	32MB
32MB×2	-----	64MB
64MB×2	-----	128MB
4MB×2	4MB×2	16MB
8MB×2	4MB×2	24MB
16MB×2	4MB×2	40MB
32MB×2	4MB×2	72MB
64MB×2	4MB×2	136MB
8MB×2	8MB×2	32MB
16MB×2	8MB×2	48MB
32MB×2	8MB×2	80MB
64MB×2	8MB×2	144MB
16MB×2	16MB×2	64MB
32MB×2	16MB×2	96MB
64MB×2	16MB×2	160MB
32MB×2	32MB×2	128MB
64MB×2	32MB×2	192MB
64MB×2	64MB×2	256MB

(2) 168-pin DIMM (3.3V)
SDRAM or EDO DRAM

Bank0 (DIMM2)	Bank1 (DIMM1)	Total Memory
8MB	-----	8MB
16MB	-----	16MB
32MB	-----	32MB
64MB	-----	64MB
128MB	-----	128MB
8MB	8MB	16MB
16MB	8MB	24MB
32MB	8MB	40MB
64MB	8MB	72MB
128MB	8MB	136MB
16MB	16MB	32MB
32MB	16MB	48MB
64MB	16MB	80MB
128MB	16MB	144MB
32MB	32MB	64MB
64MB	32MB	96MB
128MB	32MB	160MB
64MB	64MB	128MB
128MB	64MB	192MB
128MB	128MB	256MB

3.4 BIOS

The BIOS on the AI5VG motherboard provides the standard BIOS functions plus the following additional features:

1. DMI (Desktop Management Interface)

The motherboard supports DMI to enable computer system management in an enterprise.

2. ISA Plug and Play (PnP) Extension

Unlike PCI cards which are plug and play, ISA cards require setting jumpers to resolve hardware conflicts. To make a computer system PnP, an ISA PnP standard is established and supported by new OSes, such as Windows 95. Under Windows 95, the motherboard BIOS must have ISA PnP extension to support the new ISA PnP cards.

3. Power Management

The power management feature provides power savings by slowing down the CPU clock, turning off the monitor screen and stopping the HDD spindle motor.

3.5 Onboard PCI EIDE

The PCI EIDE controller is part of the VP3AT chipset. It supports PIO mode 3/4 and bus mastering. The peak transfer rate of PIO mode 3/4 can be as high as 17MB/sec. Using HDDs that support bus mastering, the peak transfer rate can reach 22MB/sec. There are two IDE connectors, primary IDE and secondary IDE. With two devices per connector, up to four IDE drives are supported. The VP3AT also supports Ultra DMA/33, a new “synchronous DMA” protocol for faster data transfers.

3.6 Onboard Multi-I/O

The onboard multi-I/O chip, Winbond W83877, supports two 16550 UART-compatible serial ports, one high speed EPP/ECP parallel port and one floppy controller. The floppy controller supports 2.88MB format. The I/O port addresses of the serial and parallel ports are programmable via BIOS set-up.

3.7 Onboard CPU Temperature Sensor

The AD22105 IC on the motherboard is a temperature sensor for the CPU. When the CPU temperature exceeds threshold value, the CPU slows down automatically to allow it to cool down to a safe level.

3.8 I/O Port Address Map

Each peripheral device in the system is assigned a set of I/O port addresses which also becomes the identity of the device. There are a total of 1K port address space available. The following table lists the I/O port addresses used on the motherboard.

Address	Device Description
000h - 01Fh	DMA Controller #1
020h - 03Fh	Interrupt Controller #1
040h - 05Fh	Timer
060h - 06Fh	Keyboard Controller
070h - 07Fh	Real Time Clock, NMI
080h - 09Fh	DMA Page Register
0A0h - 0BFh	Interrupt Controller #2
0C0h - 0DFh	DMA Controller #2
0F0h	Clear Math Coprocessor Busy Signal
0F1h	Reset Math Coprocessor
1F0h - 1F7h	IDE Interface
278 - 27F	Parallel Port #2 (LPT2)
2F8h - 2FFh	Serial Port #2 (COM2)
2B0 - 2DF	Graphics adapter Controller
378h - 3FFh	Parallel Port #1(LPT1)
360 - 36F	Network Ports
3B0 - 3BF	Monochrome & Printer adapter
3C0 - 3CF	EGA adapter
3D0 - 3DF	CGA adapter
3F0h - 3F7h	Floppy Disk Controller
3F8h - 3FFh	Serial Port #1 (COM1)

3.9 DMA Channels

There are seven DMA Channels available on the motherboard. Only DMA2 is used by the floppy controller. In the case that ECP mode on the parallel port is used, DMA1 or DMA3 will be used.

3.10 Interrupt Request Lines (IRQ)

There are a total of 15 IRQ lines available on the motherboard. Peripheral devices use interrupt request lines to notify the CPU for the service required. The following table shows the IRQ used by the devices on the motherboard.

Level	Function
IRQ0	System Timer Output
IRQ1	Keyboard
IRQ2	Interrupt Cascade
IRQ3	Serial Port #2
IRQ4	Serial Port #1
IRQ5	Parallel Port #2
IRQ6	Floppy Disk Controller
IRQ7	Parallel Port #1
IRQ8	Real Time Clock
IRQ9	Software Redirected to Int 0Ah
IRQ10	Reserved
IRQ11	Reserved
IRQ12	Reserved
IRQ13	80287
IRQ14	Primary IDE
IRQ15	Secondary IDE

3.11 Accelerated Graphics Port (AGP) Slot

The AI5VG motherboard comes with an AGP slot for an AGP VGA card that supports 133MHz 2X mode for AD and SBA signaling to provide high-performance 3D graphic display.



Chapter 4 Hardware Settings

The following sections describe the necessary procedures and proper jumper settings to configure the AI5VG motherboard.

- 4.1 SW1(1-8): CPU Frequency Selector 14
- 4.2 SW2(1-4): CPU Voltage Selector 16
- 4.3 JP5: Clear CMOS Selection 18

For the locations of the jumpers, refer to Figure 2 on the following page.

The following examples show the conventions used in this chapter

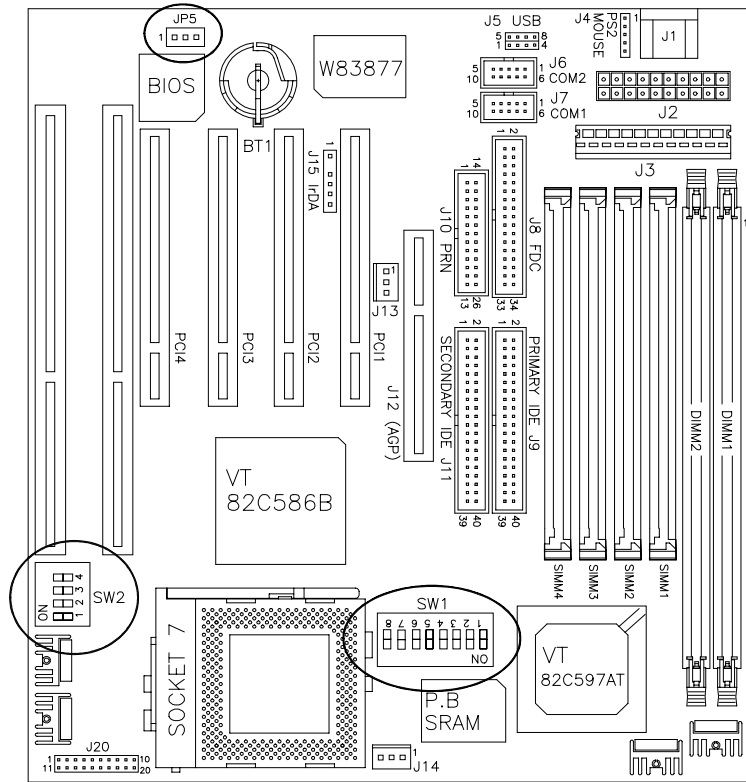

	Jumper Open
	Jumper Closed

	Switch 1 and switch 2 are set to OFF. Switch 3 and switch 4 are set to ON.
---	---



4.1 SW1(1-8): CPU Frequency Selector

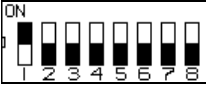
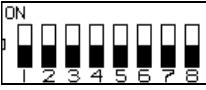
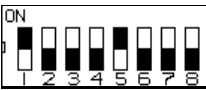
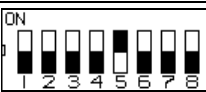
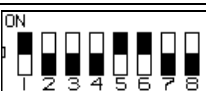
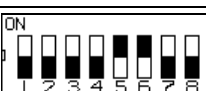

For Intel Pentium CPU

SW1	Bus Clock	Mutiplier	CPU FREQ.
 <p>on off off off off off off off</p>	60MHz	1.5x	P54C-90
 <p>off off off off off off off off</p>	66MHz	1.5x	P54C-100
 <p>on off off on on on off off</p>	60MHz	2x	P54C-120
 <p>off off off on on on off off</p>	66MHz	2x	P54C-133
 <p>on off off on on on off off</p>	60MHz	2.5x	P54C-150
 <p>off off off on on on off off</p>	66MHz	2.5x	P54C/P55C-166
 <p>off off off off on on off off</p>	66MHz	3x	P54C/P55C-200
 <p>off off off off off off off off</p>	66MHz	3.5x	P55C-233



*P55C = Pentium with MMX technology

NOTE: SW1(4) and SW1(8) are inconsequential. They could be set to either ON or OFF.

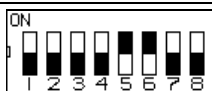

For Cyrix 6x86, 6x86L CPU

SW1	Bus Clock	Mutiplier	CPU FREQ.
 <p>on off off off on off off off</p>	60MHz	2x	P150+ (120MHz)
 <p>off off off on off off off</p>	66MHz	2x	P166+ (133MHz)

For Cyrix 6x86MX CPU

SW1	Bus Clock	Mutiplier	CPU FREQ.
 <p>off off off on on off off</p>	66MHz	2.5x	PR200 (166MHz)
 <p>off off off off on on off</p>	66MHz	3x	PR233 (200MHz)
 <p>off off off off off off off</p>	66MHz	3.5x	PR266 (233MHz)

For AMD K5, K6 CPU

SW1	Bus Clock	Mutiplier	CPU FREQ.
 <p>on off off off off off off off</p>	60MHz	1.5x	PR90
 <p>off off off off off off off off</p>	66MHz	1.5x	PR100
 <p>off off off on off off off off</p>	66MHz	2x	PR133

SW1	Bus Clock	Mutiplier	CPU FREQ.
<p>off off off off on on off off</p>	66MHz	2.5x	PR166 / K6-166
<p>off off off off off on off off</p>	66MHz	3x	K6-200
<p>off off off off off off off on</p>	66MHz	3.5x	K6-233

4.2 SW2(1-4): CPU Voltage Selector







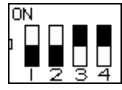

For Single Voltage CPU: Intel P54C, Cyrix 6x86, AMD K5, C6

SW2	V _{IO}	V _{CORE}
<p>on on on on</p>	3.5V	3.5V

For Dual Voltage CPU:
Intel P55C, Cyrix 6x86L/MX, AMD K6

SW2	V _{IO}	V _{CORE}	CPU
<p>on on on on</p>	3.3V	3.5V	
<p>off on on on</p>	3.3V	3.4V	
<p>on off on on</p>	3.3V	3.3V	

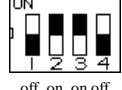
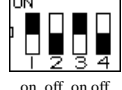
For Dual Voltage CPU:
Intel P55C, Cyrix 6x86L/MX, AMD K6

SW2	V _{IO}	V _{CORE}	CPU
 off off on on	3.3V	3.2V	K6-233 (0.35μ)
 on on off on	3.3V	3.1V	
 off on off on	3.3V	3.0V	
 on off off on	3.3V	2.9V	K6-166/200 6x86MX
 off off off on	3.3V	2.8V	P55C 6x86L
 on on on off	3.3V	2.7V	
 off on on off	3.3V	2.6V	
 on off on on	3.3V	2.5V	
 off off on on	3.3V	2.4V	
 on on off off	3.3V	2.3V	

For Dual Voltage CPU:
Intel P55C, Cyrix 6x86L/MX, AMD K6

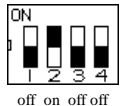
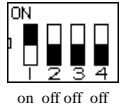
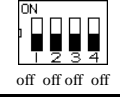
SW2	V _{IO}	V _{CORE}	CPU
 off on off off	3.3V	2.2V	K6-233 (0.25μ)
 on off off off	3.3V	2.1V	K6-233 (0.25μ)
 off off off off	3.3V	2.0V	

4.3 JP5: Clear CMOS Selection

Use JP5, a 3-pin header, to clear the contents of the CMOS RAM. Do not clear the CMOS RAM unless it is absolutely necessary. You will lose your password, etc.

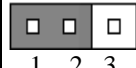
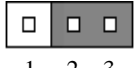
JP5	Function	JP5	Function
 1 2 3	Normal	 1 2 3	Clear CMOS

NOTE: If you are using an ATX power supply, the ATX-power connector should be disconnected from the motherboard to be able to clear CMOS.

Chapter 5 Installation

This chapter describes the connectors and interfaces that the AI5VG provides for creating a working system. Refer to Figure 3 for the location of the connectors.

The following items are covered in this chapter:

5.1 I/O Connectors	21
5.2 J3: AT Power Supply Connector.....	21
5.3 J2: ATX Power Supply Connector.....	22
5.4 J1, J4: AT Keyboard and PS/2 Mouse Connectors	22
5.5 J7, J6: Serial Ports.....	23
5.6 J8: Floppy Drive Connector	23
5.7 J9, J11: EIDE Connectors	24
5.8 J10: Parallel Port Connector	25
5.9 J15: IrDA Connector.....	25
5.10 J5: USB Connector.....	25
5.11 J13 Wake on LAN Connector	26
5.12 J14: CPU Fan Power Connector.....	26
5.13 J20 Front Bezel Connector.....	26

5.1 I/O Connectors

The I/O connectors connect the AI5VG to the most common peripherals. To attach cables to these connectors, carefully align Pin 1 of the cables to that of the connectors. Refer to Figure 4 for the location and orientation of the connectors.

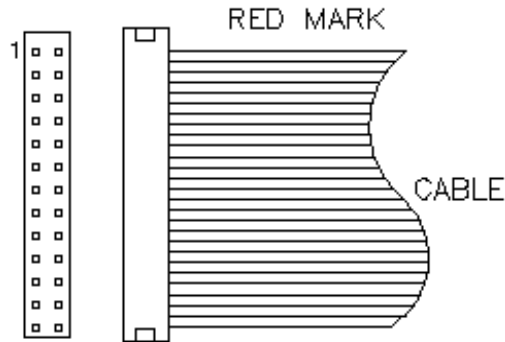

Figure 4: Orientation of the I/O Connector

5.2 J3: AT Power Supply Connector

When using an AT compatible power supply, plug both of the power supply connectors into J3. Make sure the power supply connectors are connected in the right orientation. The power supply connectors are connected in the right orientation if the black wires of each power cable are ADJACENT to each other. That is, black wires of each connector should be aligned in the center of the J3 power supply connector.

J3 Pin #		Description	Wire Color
1	⊖	Power Good	Orange
2	●	+5V	Red
3	●	+12V	Yellow
4	●	-12V	Blue
5	●	Ground	Black
6	●	Ground	Black
7	⊖	Ground	Black
8	●	Ground	Black
9	●	-5V	White
10	●	+5V	Red
11	●	+5V	Red
12	●	+5V	Red

5.3 J2: ATX Power Supply Connector

J2 is a 20-pin ATX power supply connector. Refer to the following table for the pin out assignments.

Signal Name	Pin #	Pin #	Signal Name
3.3V	11	1	3.3V
-12V	12	2	3.3V
Ground	13	3	Ground
PS-ON	14	4	+5V
Ground	15	5	Ground
Ground	16	6	+5V
Ground	17	7	Ground
-5V	18	8	Power good
+5V	19	9	5VSB
+5V	20	10	+12V

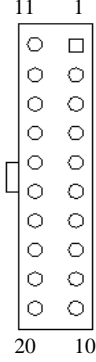

5.4 J1, J4: AT Keyboard and PS/2 Mouse Connectors

J1: AT Keyboard Connector

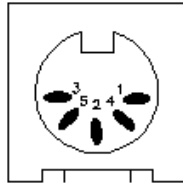

Pin #	Signal Name
1	Keyboard clock
2	Keyboard data
3	N.C.
4	GND
5	5V

J4: PS/2 Mouse Connector



Pin #	Signal Name
1	Mouse data
2	N.C.
3	GND
4	5V
5	Mouse Clock

5.5 J7, J6: Serial Ports

The onboard serial ports of the AI5VG are 10 pin-header connectors. J7 is COM1 and J6 is COM2. The following table shows the pin out of the these connectors.

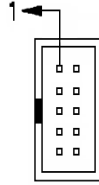

Pin #	Signal Name
1	DCD, Data carrier detect
2	RXD, Receive data
3	TXD, Transmit data
4	DTR, Data terminal ready
5	GND, ground
6	DSR, Data set ready
7	RTS, Request to send
8	CTS, Clear to send
9	RI, Ring indicator
10	Not Used

5.6 J8: Floppy Drive Connector

J8 of the AI5VG is a 34-pin header and will support up to 2.88MB floppy drives.

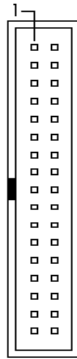

Signal Name	Pin #	Pin #	Signal Name
Ground	1	2	RM/LC
Ground	3	4	No connect
Ground	5	6	No connect
Ground	7	8	Index
Ground	9	10	Motor enable 0
Ground	11	12	Drive select 1
Ground	13	14	Drive select 0
Ground	15	16	Motor enable 1
Ground	17	18	Direction
Ground	19	20	Step
Ground	21	22	Write data
Ground	23	24	Write gate
Ground	25	26	Track 00
Ground	27	28	Write protect
Ground	29	30	Read data
Ground	31	32	Side 1 select
Ground	33	34	Diskette change

5.7 J9, J11: EIDE Connectors

J9: Primary IDE Connector

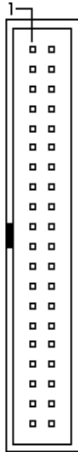

Signal Name	Pin #	Pin #	Signal Name
Reset IDE	1	2	Ground
Host data 7	3	4	Host data 8
Host data 6	5	6	Host data 9
Host data 5	7	8	Host data 10
Host data 4	9	10	Host data 11
Host data 3	11	12	Host data 12
Host data 2	13	14	Host data 13
Host data 1	15	16	Host data 14
Host data 0	17	18	Host data 15
Ground	19	20	Key
DRQ0	21	22	Ground
Host IOW	23	24	Ground
Host IOR	25	26	Ground
IOCHRDY	27	28	Host ALE
DACK0	29	30	Ground
IRQ14	31	32	No connect
Address 1	33	34	No connect
Address 0	35	36	Address 2
Chip select 0	37	38	Chip select 1
Activity	39	40	Ground

J11: Secondary IDE Connector

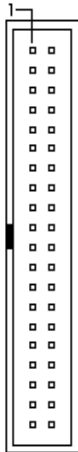

Signal Name	Pin #	Pin #	Signal Name
Reset IDE	1	2	Ground
Host data 7	3	4	Host data 8
Host data 6	5	6	Host data 9
Host data 5	7	8	Host data 10
Host data 4	9	10	Host data 11
Host data 3	11	12	Host data 12
Host data 2	13	14	Host data 13
Host data 1	15	16	Host data 14
Host data 0	17	18	Host data 15
Ground	19	20	Key
DRQ0	21	22	Ground
Host IOW	23	24	Ground
Host IOR	25	26	Ground
IOCHRDY	27	28	Host ALE
DACK1	29	30	Ground
MIRQ0	31	32	No connect
Address 1	33	34	No connect
Address 0	35	36	Address 2
Chip select 0	37	38	Chip select 1
Activity	39	40	Ground

5.8 J10: Parallel Port Connector

The following table describes the pin out assignments of this connector.

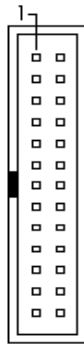

Signal Name	Pin #	Pin #	Signal Name
Line printer strobe	1	14	AutoFeed
PD0, parallel data 0	2	15	Error
PD1, parallel data 1	3	16	Initialize
PD2, parallel data 2	4	17	Select
PD3, parallel data 3	5	18	Ground
PD4, parallel data 4	6	19	Ground
PD5, parallel data 5	7	20	Ground
PD6, parallel data 6	8	21	Ground
PD7, parallel data 7	9	22	Ground
ACK, acknowledge	10	23	Ground
Busy	11	24	Ground
Paper empty	12	25	Ground
Select	13	N/A	N/A

5.9 J15: IrDA Connector

This connector is used for an IrDA connector that supports infrared wireless communication with IrDA devices.

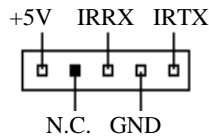

Pin #	Signal Name
1	+5V
2	No connect
3	Ir RX
4	Ground
5	Ir TX

5.10 J5: USB Connector

J5 is the USB connector on AI5VG. The following table shows the pin out assignments of these connectors.

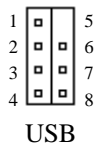

Pin #	Signal Name
1	Vcc
2	USB-
3	USB+
4	Ground

5.11 J13 Wake on LAN Connector

J13 is a 3-pin header for Wake on LAN function on the motherboard.

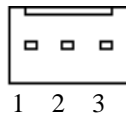

Pin #	Signal Name
1	5VSB
2	Ground
3	Wake on LAN

5.12 J14: CPU Fan Power Connector

J14 is a 3-pin header for the CPU fan power connector. The fan must be a 12V fan.

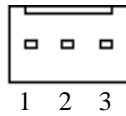

Pin #	Signal Name
1	Rotation
2	+12V
3	Ground

5.13 J20 Front Bezel Connector

The front bezel of the case has a control panel which provides light indication of the computer activities and switches to change the computer status. J20 is a 20-pin header that provides interfaces for the following functions.

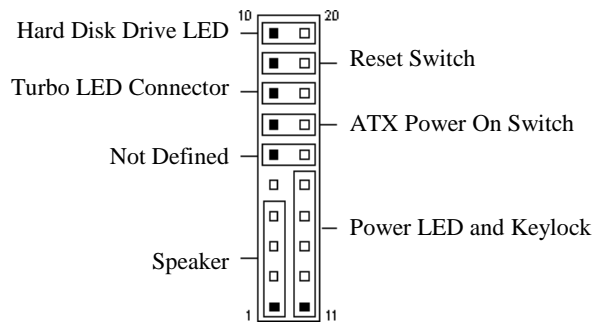

Speaker: Pins 1 - 4

This connector provides an interface to a speaker for audio tone generation. An 8-ohm speaker is recommended.

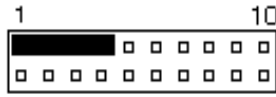

J20 Pin #	Signal Name
1	Speaker out
2	No connect
3	Ground
4	+5V

Power LED and Keylock: Pins 11 - 15

The power LED indicates the status of the main power switch. The keylock switch, when closed, will disable the keyboard function.



J20 Pin #	Signal Name
11	Power LED
12	No connect
13	Ground
14	Keylock
15	Ground

ATX Power ON Switch: Pins 7 and 17

This 2-pin connector is an “ATX Power Supply On/Off Switch” on the motherboard that connects to the power switch on the case. When pressed for more than 4 seconds, the power switch will force the motherboard to power off. When pressed for less than 4 seconds, it will force the motherboard to enter the Suspend Mode (depending on BIOS presettings).

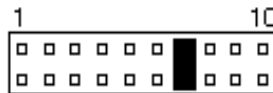

Turbo LED Connector: Pins 8 and 18

There is no turbo/deturbo function on the motherboard. The Turbo LED on the control panel will always be On when attached to this connector.

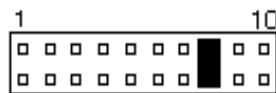

J20 Pin #	Signal Name
8	5V
18	Ground

Reset Switch: Pins 9 and 19

The reset switch allows the user to reset the system without turning the main power switch Off and then On. Orientation is not required when making a connection to this header.

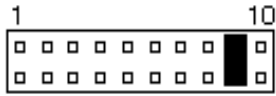

Hard Disk Drive LED Connector: Pins 10 and 20

This connector connects to the hard drive activity LED on control panel. This LED will flash when the HDD is being accessed.

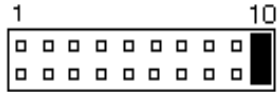

J20 Pin #	Signal Name
10	Ground
20	5V

Chapter 6 BIOS Configuration

This chapter describes the different settings available in the Award BIOS that comes with the AI5VG motherboard. The topics covered in this chapter are as follows:

6.1 BIOS Introduction.....	32
6.2 BIOS Setup	32
6.3 Standard CMOS Setup	34
Date	
Time	
Primary HDDs / Secondary HDDs	
Drive A / Drive B	
Floppy 3 Mode Support	
Video	
Halt On	
6.4 BIOS Features Setup	37
Virus Warning	
CPU Internal Cache / External Cache	
Quick Power On Self Test	
Boot Sequence	
Swap Floppy Drive	
Boot Up Floppy Seek	
Boot Up NumLock Status	
Boot Up System Speed	
Gate A20 Option	
Memory Parity/ECC Check	
Typematic Rate Setting	
Typematic Rate (Chars/Sec)	
Typematic Delay (Msec)	
Security Option	
PCI/VGA Palette Snoop	
OS Select for DRAM > 64MB	
Video BIOS Shadow	
C8000 - CBFFF Shadow/DC000 - DFFFF Shadow	
6.5 Chipset Features Setup	40
Bank DRAM Timing	
DRAM Read Pipeline	
Sustained 3T Write	

Cache Rd+CPU Wt Pipeline	
Read Around Write	
Cache Timing	
Video BIOS Cacheable	
System BIOS Cacheable	
Memory Hole at 15MB Addr.	
AGP	
Aperture Size	
OnChip USB	
6.6 Power Management Setup	42
Power Management	
PM Control by APM	
Video Off Method	
Modem Use IRQ	
Soft-Off by PWRBTN	
HDD Power Down	
Doze Mode	
Suspend Mode	
PM Events	
6.7 PNP/PCI Configuration	
PNP OS Installed	
Resources Controlled by	
Reset Configuration Data	
IRQ3/4/5/7/9/10/11/12/14/15, DMA0/1/3/5/6/7 assigned to	
CPU to PCI Write Buffer	
PCI Dynamic Bursting	
PCI Master 0 WS Write	
PCI Delay Transaction	
PCI Master Read Prefetch	
PCI#2 Access #1 Retry	
PCI Master 1 WS Write	
PCI Master 1 WS Read	
PCI IRQ Activated by	
PCI IDE IRQ Map To	
6.8 Load BIOS Defaults	48
6.9 Load Setup Defaults	48
6.10 Integrated Peripherals.....	49
OnChip Primary/Secondary PCI IDE	
IDE Prefetch Mode	
IDE HDD Block Mode	

IDE Primary/Secondary Master/Slave PIO	
IDE Primary/Secondary Master/Slave UDMA	
Onboard FDD Controller	
Onboard Serial/Parallel Port	
UART 2 Mode	
Onboard Parallel Mode	
6.11 Supervisor / User Password.....	51
6.12 IDE HDD Auto Detection.....	52
6.13 HDD Low Level Format	52
6.14 Save & Exit Setup	53
6.15 Exit Without Saving.....	53

6.1 BIOS Introduction

The Award BIOS (Basic Input/Output System) installed in your computer system's ROM supports Intel/Cyrix/AMD processors in a standard IBM-AT compatible I/O system. The BIOS provides critical low-level support for standard devices such as disk drives, serial and parallel ports. It also adds virus and password protection as well as special support for detailed fine-tuning of the chipset controlling the entire system.

6.2 BIOS Setup

The Award BIOS provides a Setup utility program for specifying the system configurations and settings. The BIOS ROM of the system stores the Setup utility. When you turn on the computer, the Award BIOS is immediately activated. Pressing the key immediately allows you to enter the Setup utility. If you are a little bit late pressing the key, POST(Power On Self Test) will continue with its test routines, thus preventing you from invoking the Setup. If you still wish to enter Setup, restart the system by pressing the "Reset" button or simultaneously pressing the <Ctrl>, <Alt> and <Delete> keys. You can also restart by turning the system Off and back On again. The following message will appear on the screen:

Press to Enter Setup

In general, you press the arrow keys to highlight items, <Enter> to select, the <PgUp> and <PgDn> keys to change entries, <F1> for help and <Esc> to quit.

When you enter the Setup utility, the Main Menu screen will appear on the screen. The Main Menu allows you to select from various setup functions and exit choices.

ROM PCI/ISA BIOS
CMOS SETUP UTILITY
AWARD SOFTWARE, INC.

STANDARD CMOS SETUP	INTEGRATED PERIPHERALS
BIOS FEATURES SETUP	SUPERVISOR PASSWORD
CHIPSET FEATURES SETUP	USER PASSWORD
POWER MANAGEMENT SETUP	IDE HDD AUTO DETECTION
PNP/PCI CONFIGURATION	HDD LOW LEVEL FORMAT
LOAD BIOS DEFAULTS	SAVE & EXIT SETUP
LOAD SETUP DEFAULTS	EXIT WITHOUT SAVING
ESC : Quit	↑ ↓ → ← : Select Item
F10 : Save & Exit Setup	(Shift) F2 : Change Color
Time, Date, Hard Disk Type	

The section below the setup items of the Main Menu displays the control keys for this menu. Another section at the bottom of the Main Menu just below the control keys section displays information on the currently highlighted item in the list.

NOTE: After making and saving system changes with Setup, you find that your computer cannot boot, the Award BIOS supports an override to the CMOS settings that resets your system to its default.

We strongly recommend that you avoid making any changes to the chipset defaults. These defaults have been carefully chosen by both Award and your system manufacturer to provide the absolute maximum performance and reliability.

6.3 Standard CMOS Setup

“Standard CMOS Setup” choice allows you to record some basic hardware configurations in your computer system and set the system clock and error handling. If the motherboard is already installed in a working system, you will not need to select this option. You will need to run the Standard CMOS option, however, if you change your system hardware configurations, the onboard battery fails, or the configuration stored in the CMOS memory was lost or damaged.

ROM PCI/ISA BIOS
STANDARD CMOS SETUP
AWARD SOFTWARE, INC.

Date (mm:dd:yy) : Mon , Aug 19 1996								
Time (hh:mm:ss) : 00 : 00 : 00								
HARD DISKS	TYPE	SIZE	CYLS	HEAD	PRECOMP	LANDZ	SECTOR	MODE
Primary Master	Auto	0	0	0	0	0	0	Auto
Primary Slave	None	0	0	0	0	0	0	-----
Secondary Master	None	0	0	0	0	0	0	-----
Secondary Slave	None	0	0	0	0	0	0	-----
Drive A	: 1.44M, 3.5in			Base Memory				: 640K
Drive B	: None			Extended Memory				: 15360K
Floppy 3 Mode Support	: Disabled			Other Memory				: 384K
Video	: EGA / VGA			Total Memory				: 16384K
Halt On	: All Errors							
ESC : Quit			↑ ↓ → ← : Select		Item		PU / PD / + / - : Modify	
F1 : Help			(Shift) F2 : Change Color					

At the bottom of the menu are the control keys for use on this menu. If you need any help in each item field, you can press the <F1> key. It will display the relevant information to help you. The memory display at the lower right-hand side of the menu is read-only. It will adjust automatically according to the memory changed. The following describes each item of this menu.

Date

The date format is:

Day : Sun to Sat
Month : 1 to 12
Date : 1 to 31
Year : 1994 to 2079

To set the date, highlight the “Date” field and use the PageUp/PageDown or +/- keys to set the current time.

Time

The time format is: **Hour : 00 to 23**
Minute : 00 to 59
Second : 00 to 59

To set the time, highlight the "Time" field and use the <PgUp>/<PgDn> or +/- keys to set the current time.

Primary HDDs / Secondary HDDs

The onboard PCI IDE connectors provide Primary and Secondary channels for connecting up to four IDE hard disks or other IDE devices. Each channel can support up to two hard disks; the first is the "Master" and the second is the "Slave".

To enter the specifications for a hard disk drive, you must select first a "Type". There are 45 predefined types and 4 user definable types are for Enhanced IDE BIOS. Type 1 to 45 are predefined. Type "User" is user-definable. For the Primary Master/Slave as well as Secondary Master/Slave, you can select "Auto" under the TYPE and MODE fields. This will enable auto detection of your IDE drives and CD-ROM drive during POST.

Press <PgUp>/<PgDn> to select a numbered hard disk type or type the number and press the <Enter> key. The hard disk will not work properly if you enter incorrect information for this field. If your hard disk drive type is not matched or listed, you can use Type User to define your own drive type manually. If you select Type User, related information is asked to be entered to the following items.

CYLS : Number of cylinders
HEAD : Number of read/write heads
PRECOMP : Write precompensation
LANDZ : Landing zone
SECTOR : Number of sectors
SIZE : Automatically adjust according to the configuration
MODE (for IDE HDD only) : Auto
Normal (HD < 528MB)
Large (for MS-DOS only)
LBA (HD > 528MB and supports
Logical Block Addressing)

NOTE: The specifications of your drive must match with the drive table. The hard disk will not work properly if you enter incorrect information in these fields. If your hard disk drive type is not matched or listed, you can use Type User to define your own drive type manually.

Drive A / Drive B

These fields identify the types of floppy disk drive A or drive B that has been installed in the computer. The available specifications are:

360KB 1.2MB 720KB 1.44MB 2.88MB
5.25 in. 5.25 in. 3.5 in. 3.5 in. 3.5 in.

Floppy 3 Mode Support

This is the Japanese standard floppy drive. The standard stores 1.2MB in a 3.5-inch diskette. You have four options to choose:

Disabled	No 3 mode floppy drive installed. (default)
Drive A	Installed 3 mode drive at drive A.
Drive B	Installed 3 mode drive at drive B.
Both	Installed 3 mode drive at drive A and B.

Video

This field selects the type of video display card installed in your system. You can choose the following video display cards:

EGA/VGA	For EGA, VGA, SEGA, SVGA or PGA monitor adapters. (default)
CGA 40	Power up in 40 column mode.
CGA 80	Power up in 80 column mode.
MONO	For Hercules or MDA adapters.

Halt On

This field determines whether the system will halt if an error is detected during power up.

No errors	Whenever the BIOS detects a non-fatal error, the system will stop and you will be prompted.
All errors	The system boot will not be halted for any error that may be detected. (default)
All, But Keyboard	The system boot will not be halted for a keyboard error; it will stop for all other errors.
All, But Diskette	The system boot will not be halted for a disk error; it will stop for all other errors.
All, But Disk/Key	The system boot will not be halted for a keyboard or disk error; it will stop for all others.

6.4 BIOS Features Setup

This section allows you to configure and improve your system and allows you to set up some system features according to your preference.

ROM / PCI ISA BIOS BIOS FEATURES SETUP AWARD SOFTWARE, INC.			
Virus Warning	: Disabled	Video BIOS Shadow	: Enabled
CPU Internal Cache	: Enabled	C8000-CBFFF Shadow	: Disabled
External Cache	: Enabled	CC000-CFFFF Shadow	: Disabled
Quick Power On Self Test	: Enabled	D0000-D3FFF Shadow	: Disabled
Boot Sequence	: A, C, SCSI	D4000-D7FFF Shadow	: Disabled
Swap Floppy Drive	: Disabled	D8000-DBFFF Shadow	: Disabled
Boot Up Floppy Drive	: Enabled	DC000-DFFF Shadow	: Disabled
Boot Up Numlock Status	: On		
Boot Up System Speed	: High		
Gate A20 Option	: Fast		
Memory Parity/ECC Check	: Disabled		
Typematic Rate Setting	: Disabled		
Typematic Rate (chars/Sec)	: 6		
Typematic Delay (Msec)	: 250		
Security Option	: Setup		
PCI /VGA Palette Snoop	: Disabled		
OS Select For DRAM>64MB	: Non-OS2		
		ESC : Quit	↑ ↓ → ← : Select Item
		F1 : Help	PU/PD/+/- : Modify
		F5 : Old Values	(Shift) F2 : Color
		F6 : Load BIOS Defaults	
		F7 : Load Setup Defaults	

Virus Warning

This item protects the boot sector and partition table of your hard disk against accidental modifications. If an attempt is made, the BIOS will halt the system and display a warning message. If this occurs, you can either allow the operation to continue or run an anti-virus program to locate and remove the problem.

NOTE: Many disk diagnostic programs which attempt to access the boot sector table can cause the virus warning. If you will run such a program, disable the Virus Warning feature.

CPU Internal Cache / External Cache

These items allow you to enable (speed up memory access) or disable the cache function. By default, these items are **Enabled**.

Quick Power On Self Test

This choice speeds up the Power On Self Test (POST) after you power up the system. If it is set to *Enabled*, BIOS will skip some items. By default, this choice is *Enabled*.

Boot Sequence

This field determines the drive that the system searches first for an operating system. The options are :

A, C, SCSI	D, A, SCSI	SCSI, C, A
C, A, SCSI	E, A, SCSI	C only
C, CDROM, A	F, A, SCSI	LS/ZIP, C
CDROM, C, A	SCSI, A, C	

The default value is *A, C, SCSI*.

Swap Floppy Drive

This item allows you to determine whether to enable Swap Floppy Drive or not. When enabled, the BIOS swaps floppy drive assignments so that Drive A becomes Drive B, and Drive B becomes Drive A. By default, this field is set to *Disabled*.

Boot Up Floppy Seek

When enabled, the BIOS will seek whether or not the floppy drive installed has 40 or 80 tracks. 360K type has 40 tracks while 760K, 1.2M and 1.44M all have 80 tracks. By default, this field is set to *Enabled*.

Boot Up NumLock Status

This allows you to activate the NumLock function after you power up the system. By default, the system boots up with *NumLock* On.

Boot Up System Speed

This has no function and selects the default system speed (*High*).

Gate A20 Option

This field allows you to select how Gate A20 is worked. The Gate A20 is a device used to address memory above 1 MB. By default, this field is set to *Fast*.

Memory Parity/ECC Check

Set this option to Enabled, when the memory installed in your system supports ECC (error correction code) or parity. By default, this field is set to *Disabled*.

Typematic Rate Setting

When disabled, continually holding down a key on your keyboard will generate only one instance. When enabled, you can set the two typematic controls listed next. By default, this field is set to *Disabled*.

Typematic Rate (Chars/Sec)

When the typematic rate is enabled, the system registers repeated keystrokes speeds. You can select speed range from 6 to 30 characters per second. By default, this item is set to **6**.

Typematic Delay (Msec)

When the typematic rate is enabled, this item allows you to set the time interval for displaying the first and second characters. By default, this item is set to *250msec*.

Security Option

This field allows you to limit access to the System and Setup. The default value is *Setup*. When you select *System*, the system prompts for the User Password every time you boot up. When you select *Setup*, the system always boots up and prompts for the Supervisor Password only when the Setup utility is called up.

PCI/VGA Palette Snoop

Some non-standard VGA display cards may not show colors properly. This field allows you to set whether MPEG ISA/VESA VGA Cards can work with PCI/VGA or not. When this field is enabled, a PCI/VGA can work with a MPEG ISA/VESA VGA card. When this field is disabled, a PCI/VGA cannot work with a MPEG ISA/VESA Card.

OS Select for DRAM > 64MB

This option allows the system to access greater than 64MB of DRAM memory when used with OS/2 that depends on certain BIOS calls to access memory. The default setting is *NON-OS/2*.

Video BIOS Shadow

This item allows you to change the Video BIOS location from ROM to RAM. Video Shadow will increase the video speed.

C8000 - CBFFF Shadow/DC000 - DFFFF Shadow

Shadowing a ROM reduces the memory available between 640KB to 1024KB. These fields determine whether optional ROM will be copied to RAM or not.

6.5 Chipset Features Setup

This Setup menu controls the configuration of the motherboard chipset.

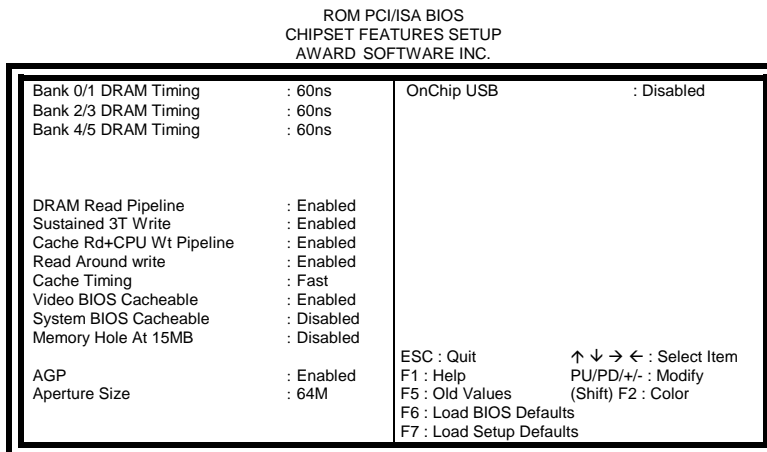

Bank DRAM Timing

These fields defines the speed of the DRAM memory onboard. The options are *Normal*, *Medium*, *Fast*, *Turbo*, *70ns* and *60ns*. By default, these fields are set to **60ns**.

DRAM Read Pipeline

When enabled, this field supports pipelining of DRAM reads The default setting is **Enabled**.

Sustained 3T Write

This field allows support for PBSRAM sustained 3T write. By default, this field is set **Enabled**.

Cache Rd+CPU Wt Pipeline

When enabled, this item allow pipelining of cache reads and CPU writes. The default setting is **Enabled**.

Read Around Write

DRAM optimization feature: If a memory read is addressed to a location whose latest write is being held in a buffer before being written to memory, the read is satisfied through the buffer contents, and the read is not sent to the DRAM. The default setting is **Enabled**.

Cache Timing

This field sets the timing of the cache in the system. The options are *Fast* and *Fastest*. By default, this field is set to *Fast*.

Video BIOS Cacheable

When enabled, access to video BIOS addressed at C0000H to C7FFFH are cached, provided that the cache controller is enabled.

System BIOS Cacheable

When enabled, access to the system BIOS ROM addressed at F0000H-FFFFFH are cached, provided that the cache controller is enabled.

Memory Hole at 15MB Addr.

In order to improve performance, certain space in memory can be reserved for ISA cards. This field allows you to reserve 15MB to 16MB memory address space to ISA expansion cards. This makes memory from 15MB and up unavailable to the system. Expansion cards can only access memory up to 16MB. By default, this field is set to *Disabled*.

AGP

This field enables or disables the AGP (Accelerated Graphics Port) function on the motherboard. The default setting is *Enabled*.

Aperture Size

The field sets aperture size of the graphics. The aperture is a portion of the PCI memory address range dedicated for graphics memory address space. Host cycles that hit the aperture range are forwarded to the AGP without any translation. The options available are *4M*, *8M*, *16M*, *32M*, *64M*, *128M* and *256M*. The default setting is *64M*.

OnChip USB

This field allows you either to enable or disable the USB function. By default, this field is set to *Disabled*.

6.6 Power Management Setup

The Power Management Setup allows you to save energy of your system effectively. It will shut down the hard disk and turn off video display after a period of inactivity.

ROM PCI/ISA BIOS (2A59IM29)
POWER MANAGEMENT SETUP
AWARD SOFTWARE, INC.

Power Management	: User Define	Primary INTR	: ON
PM Control by APM	: Yes	IRQ3 (COM2)	: Primary
Video Off Option	: Suspend -> Off	IRQ4 (COM1)	: Primary
Video Off Method	: V/H SYNC +Blank	IRQ5 (LPT 2)	: Primary
MODEM Use IRQ	: 3	IRQ6 (Floppy Disk)	: Primary
Soft-Off by PWRBTN	: Instant-Off	IRQ7 (LPT 1)	: Primary
		IRQ8 (RTC Alarm)	: Disabled
		IRQ9 (IRQ2 Redir)	: Secondary
		IRQ10 (Reserved)	: Secondary
		IRQ11 (Reserved)	: Secondary
		IRQ12 (PS/2 Mouse)	: Primary
		IRQ13 (Coprocessor)	: Primary
		IRQ14 (Hard Disk)	: Primary
		IRQ15 (Reserved)	: Disabled
		ESC : Quit	↑ ↓ → ← : Select Item
		F1 : Help	PU/PD/+/- : Modify
		F5 : Old Values	(Shift) F2 : Color
		F6 : Load BIOS Defaults	
		F7 : Load Setup Defaults	

Power Management

This field allows you to select the type of power saving management modes. There are four selections for Power Management.

Disabled	No power management.
Min. Power Saving	Minimum power management.
Max. Power Saving	Maximum power management. Only available for SL CPU.
User Define	Each of the ranges are from 1 min. to 1hr. Except for HDD Power Down which ranges from 1 min. to 15 min. (Default)

NOTE: In order to enable the CPU overheat protection feature, the Power Management field should not be set to Disabled.

PM Control by APM

This field allows you to use the Advanced Power Management device to enhance the Max. Power Saving mode and stop the CPU's internal clock. If the Max. Power Saving is not enabled, this will be preset to NO.

Video Off Method

This field defines the Video Off features. There are three options.

- | | |
|------------------|--|
| V/H SYNC + Blank | Default setting, blank the screen and turn off vertical and horizontal scanning. |
| DPMS | Allows the BIOS to control the video display card if it supports the DPMS feature. |
| Blank Screen | This option only writes blanks to the video buffer. |

Modem Use IRQ

This field defines the IRQ being used by the modem. By default, the the IRQ is set to 3.

Soft-Off by PWRBTN

This field defines the power-off mode when using an ATX power supply. The *Instant Off* mode allows powering off immediately upon pressing the power button. In the *Delay 4 Sec* mode, the system powers off when the power button is pressed for more than four seconds or enters the suspend mode when pressed for less than 4 seconds. The default value is *Instant Off*.

HDD Power Down

When enabled, and after the set time of system inactivity, the hard disk drive will be powered down while all other devices remain active.

Doze Mode

When enabled, and after the set time of system inactivity, the CPU clock will run at a slower speed while all other devices still operate at full speed.

Suspend Mode

When enabled, and after the set time of system inactivity, all devices except the CPU will be shut off.

PM Events

The VGA, LPT & COM, HDD & FDD, DMA /master, Modem Ring Resume, RTC Alarm Resume and Primary INTR section are I/O events which can prevent the system from entering a power saving mode or can awaken the system from such a mode. When an I/O device wants to gain the attention of the operating system, it signals this by causing an IRQ to occur. When the operating system is ready to respond to the request, it interrupts itself and performs the service. The default value is *Off*. When set On, activity will neither prevent the system from going into a power management mode nor awaken it. The IRQ section sets the wake-up call of the system. If activity is detected from any enabled IRQ channels in the left-hand group, the system wakes up from suspended mode.

6.7 PNP/PCI Configuration

This option configures the PCI bus system. All PCI bus systems on the system use INT#, thus all installed PCI cards must be set to this value.

ROM PCI/ISA BIOS CHIPSET FEATURES SETUP AWARD SOFTWARE INC.			
PNP OS Installed	: No	CPU to PCI Write Buffer	: Enabled
Resources Controlled by	: Manual	PCI Dynamic Bursting	: Enabled
Reset Configuration Data	: Disabled	PCI Master 0 WS Write	: Enabled
		PCI Delay Transaction	: Enabled
IRQ-3 assigned to	: Legacy ISA	PCI Master Read Prefetch	: Enisabled
IRQ-4 assigned to	: Legacy ISA	PCI#2 Access #1 Retry	: Disabled
IRQ-5 assigned to	: PCI/ISA PnP	PCI Master 1 WS Write	: Enabled
IRQ-7 assigned to	: Legacy ISA	PCI Master 1 WS Read	: Disabled
IRQ-9 assigned to	: PCI/ISA PnP		
IRQ-10 assigned to	: PCI/ISA PnP	PCI IRQ Activated By	: Level
IRQ-11 assigned to	: PCI/ISA PnP	PCI IDE IRQ Map To	: PCI-Auto
IRQ-12 assigned to	: PCI/ISA PnP	Primary IDE INT#	: A
IRQ-14 assigned to	: PCI/ISA PnP	Secondary IDE INT#	: B
IRQ-15 assigned to	: PCI/ISA PnP		
DMA-0 assigned to	: PCI/ISA PnP	ESC : Quit	↑ ↓ ← : Select Item
DMA-1 assigned to	: PCI/ISA PnP	F1 : Help	PU/PD/+/- : Modify
DMA-3 assigned to	: PCI/ISA PnP	F5 : Old Values	(Shift) F2 : Color
DMA-5 assigned to	: PCI/ISA PnP	F6 : Load BIOS Defaults	
DMA-6 assigned to	: PCI/ISA PnP	F7 : Load Setup Defaults	
DMA-7 assigned to	: PCI/ISA PnP		

PNP OS Installed

This field allows you to specify if the operating system installed in your system is plug and play aware.

Note: Operating systems such as DOS, OS/2, and Windows 3.x do not use PnP.

Resources Controlled by

This PnP BIOS can configure all of the boot and compatible devices automatically. However, this capability needs you to use a PnP operating system such as Windows 95. The default value is *Manual*.

Reset Configuration Data

This field allows you to determine whether to reset the configuration data or not. The default value is *Disabled*.

IRQ3/4/5/7/9/10/11/12/14/15, DMA0/1/3/5/6/7 assigned to

These fields allow you to determine the IRQ/DMA assigned to the ISA bus and is not available to any PCI slot.

CPU to PCI Write Buffer

When enabled, this option increase the efficiency of the PCI bus to and speed up the execution in the processor. By default, this field is set to *Enabled*.

PCI Dynamic Bursting

When enabled, this option combines several PCI cycles into one. By default, this field is set to *Disabled*.

PCI Master 0 WS Write

When enabled, this option increases the write cycle speed. By default, this field is set to *Disabled*.

PCI Delay Transaction

When enabled, this option delays PCI data transaction. By default, this field is set to *Disabled*.

PCI Master Read Prefetch

When this item is enabled, the system is allowed to prefetch the next read and initiate the next process. By default, this field is set to *Disabled*.

PCI#2 Access #1 Retry

This item enables PC#2 Access #1 attempts. By default, this field is set to *Disabled*.

PCI Master 1 WS Write

When enabled, writes to the PCI bus are executed with 1 wait states. By default, this field is set to *Disabled*.

PCI Master 1 WS Read

When enabled, reads to the PCI bus are executed with 1 wait states. By default, this field is set to *Disabled*.

PCI IRQ Activated by

This field allows you to select the method by which the PCI bus recognizes that an IRQ service is being requested by a device. The default value is *Level*.

PCI IDE IRQ Map To

This field allows you to configure the type of IDE disk controller in your system. The default setup is *ISA*. If you have equipped with PCI controller, you need to specify which slot has the controller and PCI interrupt is associated with the connected hard drives. Selecting “PCI AUTO” allows the system to automatically determine your IDE disk system configuration.

6.8 Load BIOS Defaults

This option allows you to load the troubleshooting default values permanently stored in the BIOS ROM. These default settings are non-optimal and disable all high-performance features.

ROM PCI/ISA BIOS
CMOS SETUP UTILITY
AWARD SOFTWARE, INC.

STANDARD CMOS SETUP	INTEGRATED PERIPHERALS
BIOS FEATURES SETUP	SUPERVISOR PASSWORD
CHIPSET FEATURES SETUP	USER PASSWORD
POWER MANAGE	DETECTION
PNP/PCI CONF	FORMAT
LOAD BIOS DEF	UP
LOAD SETUP DEF	EXIT WITHOUT SAVING
ESC : Quit	↑ ↓ → ← : Select Item
F10 : Save & Exit Setup	(Shift) F2 : Change Color
Load BIOS Defaults except Standard CMOS Setup	

To load BIOS defaults value to CMOS SRAM, enter “Y”. If not, enter “N”.

6.9 Load Setup Defaults

This option allows you to load the default values to your system configuration. These default settings are optimal and enable all high performance features.

ROM PCI/ISA BIOS
CMOS SETUP UTILITY
AWARD SOFTWARE, INC.

STANDARD CMOS SETUP	INTEGRATED PERIPHERALS
BIOS FEATURES SETUP	SUPERVISOR PASSWORD
CHIPSET FEATURES SETUP	USER PASSWORD
POWER MANAGE	DETECTION
PNP/PCI CONF	FORMAT
LOAD BIOS DEF	UP
LOAD SETUP DEF	EXIT WITHOUT SAVING
ESC : Quit	↑ ↓ → ← : Select Item
F10 : Save & Exit Setup	(Shift) F2 : Change Color
Load BIOS Defaults except Standard CMOS Setup	

To load SETUP defaults value to CMOS SRAM, enter “Y”. If not, enter “N”.

6.10 Integrated Peripherals

This option sets your hard disk configuration, mode and port.

ROM PCI/ISA BIOS CHIPSET FEATURES SETUP AWARD SOFTWARE INC.	
OnChip IDE First Channel : Enabled	Onboard Parallel Mode : SPP
OnChip IDE Second Channel : Enabled	
IDE Prefetch Mode : Enabled	
IDE HDD Block Mode : Enabled	
IDE Primary Master PIO : Auto	
IDE Primary Slave PIO : Auto	
IDE Secondary Master PIO : Auto	
IDE Secondary Slave PIO : Auto	
IDE Primary Master UDMA : Auto	
IDE Primary Slave UDMA : Auto	
IDE Secondary Master UDMA : Auto	
IDE Secondary Slave UDMA : Auto	
Onboard FDD Controller : Enabled	
Onboard Serial Port 1 : 3F8/IRQ4	
Onboard Serial Port 2 : 2F8/IRQ3	
Uart 2 Mode : Standard	
Onboard Parallel Port : 378H/IRQ7	
	ESC : Quit ↑ ↓ ← : Select Item
	F1 : Help PU/PD/+/- : Modify
	F5 : Old Values (Shift) F2 : Color
	F6 : Load BIOS Defaults
	F7 : Load Setup Defaults

OnChip Primary/Secondary PCI IDE

These fields allow you either to enable or disable the Primary/Secondary controller. You might choose to disable the controller if you were to add a higher performance or specialized controller.

IDE Prefetch Mode

This field allows your hard disk controller to use prefetch mode to transfer data to increase the performance.

IDE HDD Block Mode

This field allows your hard disk controller to use the fast block mode to transfer data to and from your hard disk drive.

IDE Primary/Secondary Master/Slave PIO

These fields allow your system hard disk controller to work faster. Rather than have the BIOS issue a series of commands that transfer to or from the disk drive, PIO (Programmed Input/Output) allows the BIOS to communicate with the controller and CPU directly.

The system supports five modes, numbered from 0 (default) to 4, which primarily differ in timing. When Auto is selected, the BIOS will select the best available mode.

IDE Primary/Secondary Master/Slave UDMA

This field allows your system to improve disk I/O throughput to 33Mb/sec with the Ultra DMA/33 feature. The options are *Auto* and *Disabled*.

Onboard FDD Controller

This option allows you to select the onboard FDD port.

Onboard Serial/Parallel Port

These fields allow you to select the onboard serial and parallel ports and their addresses. The default value for these ports are:

Serial Port 1	3F8/IRQ4
Serial Port 2	2F8/IRQ3
Parallel Port	378H/IRQ7

UART 2 Mode

This field determines the UART 2 mode in your computer. The options are *Standard*, *HPSIR*, and *ASKIR*.

Onboard Parallel Mode

This field allows you to determine parallel port mode function.

SPP	Normal Printer Port
EPP	Enhanced Parallel Port
ECP	Extended Capabilities Port

6.11 Supervisor / User Password

These two options set the system password. *Supervisor Password* sets a password that will be used to protect the system and Setup utility. *User Password* sets a password that will be used exclusively on the system. To specify a password, highlight the type you want and press <Enter>. The **Enter Password:** message prompts on the screen. Type the password, up to eight characters in length, and press <Enter>. The system confirms your password by asking you to type it again. After setting a password, the screen automatically returns to the main screen.

To disable a password, just press the <Enter> key when you are prompted to enter the password. A message will confirm the password to be disabled. Once the password is disabled, the system will boot and you can enter Setup freely.

ROM PCI/ISA BIOS
CMOS SETUP UTILITY
AWARD SOFTWARE, INC.

STANDARD CMOS SETUP BIOS FEATURES SETUP CHIPSET FEATURES SETUP POWER MANAGE PNP/PCI CONF LOAD BIOS DEF LOAD SETUP D	INTEGRATED PERIPHERALS SUPERVISOR PASSWORD USER PASSWORD [REDACTED] DETECTION [REDACTED] FORMAT [REDACTED] SETUP [REDACTED]AVING
ESC : Quit F10 : Save & Exit Setup	↑ ↓ → ← : Select Item (Shift) F2 : Change Color
Change / Set / Disable Password	

6.12 IDE HDD Auto Detection

This option detects the parameters of an IDE hard disk drive, and automatically enters them into the Standard CMOS Setup screen.

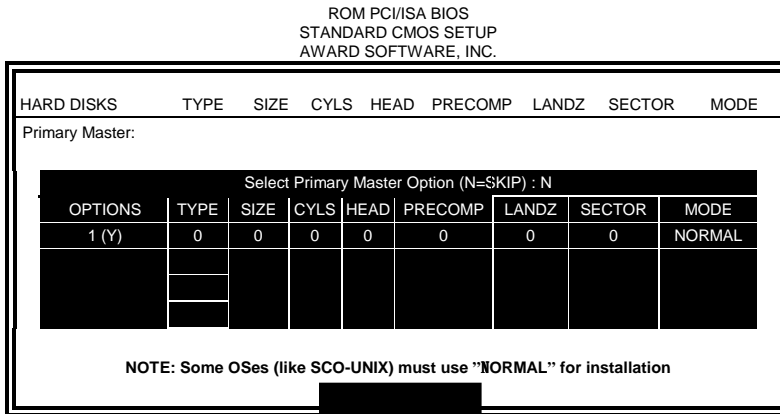

Up to four IDE drives can be detected, with parameters for each appearing in sequence inside a box. To accept the displayed entries, press the "Y" key; to skip to the next drive, press the "N" key. If you accept the values, the parameters will appear listed beside the drive letter on the screen.

6.13 HDD Low Level Format

This option should only be used by a professional. Low-level formatting can cause irreparable damage to your hard disk. The procedures include selecting the drive you want to low-level format, determining the bad tracks, and proceeding with pre-formatting.

6.14 Save & Exit Setup

This option allows you to determine whether to accept the modifications or not. If you type “Y”, you will quit the setup utility and save all changes into the CMOS memory. If you type “N”, you will return to Setup utility.

ROM PCI/ISA BIOS
CMOS SETUP UTILITY
AWARD SOFTWARE, INC.

STANDARD CMOS SETUP	INTEGRATED PERIPHERALS
BIOS FEATURES SETUP	SUPERVISOR PASSWORD
CHIPSET FEATURES SETUP	USER PASSWORD
POWER MANAGE	DETECTION
PNP/PCI CONF	FORMAT
LOAD BIOS DEF	UP
LOAD SETUP DEFAULTS	EXIT WITHOUT SAVING
ESC : Quit	↑ ↓ → ← : Select Item
F10 : Save & Exit Setup	(Shift) F2 : Change Color
Save Data to CMOS & Exit Setup	

6.15 Exit Without Saving

Select this option to exit the Setup utility without saving the changes you have made in this session. Typing “Y” will quit the Setup utility without saving the modifications. Typing “N” will return you to Setup utility.

ROM PCI/ISA BIOS
CMOS SETUP UTILITY
AWARD SOFTWARE, INC.

STANDARD CMOS SETUP	INTEGRATED PERIPHERALS
BIOS FEATURES SETUP	SUPERVISOR PASSWORD
CHIPSET FEATURES SETUP	USER PASSWORD
POWER MANAGE	DETECTION
PNP/PCI CONF	FORMAT
LOAD BIOS DEF	UP
LOAD SETUP DEFAULTS	EXIT WITHOUT SAVING
ESC : Quit	↑ ↓ → ← : Select Item
F10 : Save & Exit Setup	(Shift) F2 : Change Color
Abandon all Data & Exit Setup	