



# **SY-5EMA+**

## **Super 7™**

# **Motherboard**

\*\*\*\*\*

Pentium® Class CPU supported

ETEQ82C663 PCI/AGP Motherboard

ATX Form Factor

\*\*\*\*\*

**User's Guide**  
**&**  
**Technical Reference**

### About This Guide

This User's Guide is for assisting system manufacturers and end users in setting up and installing the Motherboard. Information in this guide has been carefully checked for reliability; however, no guarantee is given as to the correctness of the contents. The information in this document is subject to change without notice.

### Copyright Notice

Copyright 1998, Soyo Computer Inc. All rights reserved. This manual is copyrighted by Soyo Computer Inc. You may not reproduce, transmit, transcribe, store in a retrieval system, or translate into any language, in any form or by any means, electronic, mechanical, magnetic, optical, chemical, manual or otherwise, any part of this publication without express written permission of Soyo Computer Inc.

### Trademarks

Soyo is a registered trademark of Soyo Computer Inc. All trademarks are the property of their owners.

### Disclaimer

Soyo Computer Inc. makes no representations or warranties regarding the contents of this manual. We reserve the right to revise the manual or make changes in the specifications of the product described within it at any time without notice and without obligation to notify any person of such revision or change. The information contained in this manual is provided for general use by our customers. Our customers should be aware that the personal computer field is the subject of many patents. Our customers should ensure that their use of our products does not infringe upon any patents. It is the policy of Soyo Computer Inc. to respect the valid patent rights of third parties and not to infringe upon or assist others to infringe upon such rights.

### Restricted Rights Legend

Use, duplication, or disclosure by the Government is subject to restrictions set forth in subparagraph (c)(1)(ii) of the Rights in Technical Data and Computer Software clause at 252.277-7013.

### Product Rights

Products mentioned in this manual are mentioned for identification purpose only. Product names appearing in this manual may or may not be registered trademarks or copyrights of their respective companies.

If you need any further information, please come to our home page on the Internet. The address is "<http://www.soyo.com.tw>".

**Edition: December 1998**  
**Version 2.0**  
**5EMA+ SERIAL**

**FC** Tested To Comply  
With FCC Standards  
FOR HOME OR OFFICE USE

**100%** POST CONSUMER  
RECYCLED PAPER

# Table of Contents

**SY-5EMA+ MOTHERBOARD LAYOUT ..... 1**

**CHAPTER 1 INTRODUCTION..... 2**

    1-1 KEY FEATURES ..... 2

    1-2 HANDLING THE MOTHERBOARD ..... 5

    1-3 ELECTROSTATIC DISCHARGE PRECAUTIONS..... 5

**CHAPTER 2 HARDWARE SETUP ..... 6**

    2-1 PREPARATIONS .....6

    2-2 UNPACKING THE MOTHERBOARD .....7

    2-3 INSTALLATION GUIDE.....8

**CHAPTER 3 BIOS SETUP UTILITY ..... 33**

    3-1 STANDARD CMOS SETUP ..... 35

    3-2 BIOS FEATURES SETUP ..... 38

    3-3 CHIPSET FEATURES SETUP ..... 44

    3-4 POWER MANAGEMENT SETUP ..... 47

    3-5 PNP/PCI CONFIGURATION SETUP ..... 52

    3-6 LOAD SETUP DEFAULTS ..... 55

    3-7 LOAD BIOS DEFAULTS ..... 55

    3-8 INTEGRATED PERIPHERALS ..... 56

    3-9 SUPERVISOR PASSWORD ..... 60

    3-10 USER PASSWORD..... 61

    3-11 IDE HDD AUTO DETECTION ..... 62

**CHAPTER 4 DRIVERS INSTALLATION..... 63**

SY-5EMA+ Motherboard Layout

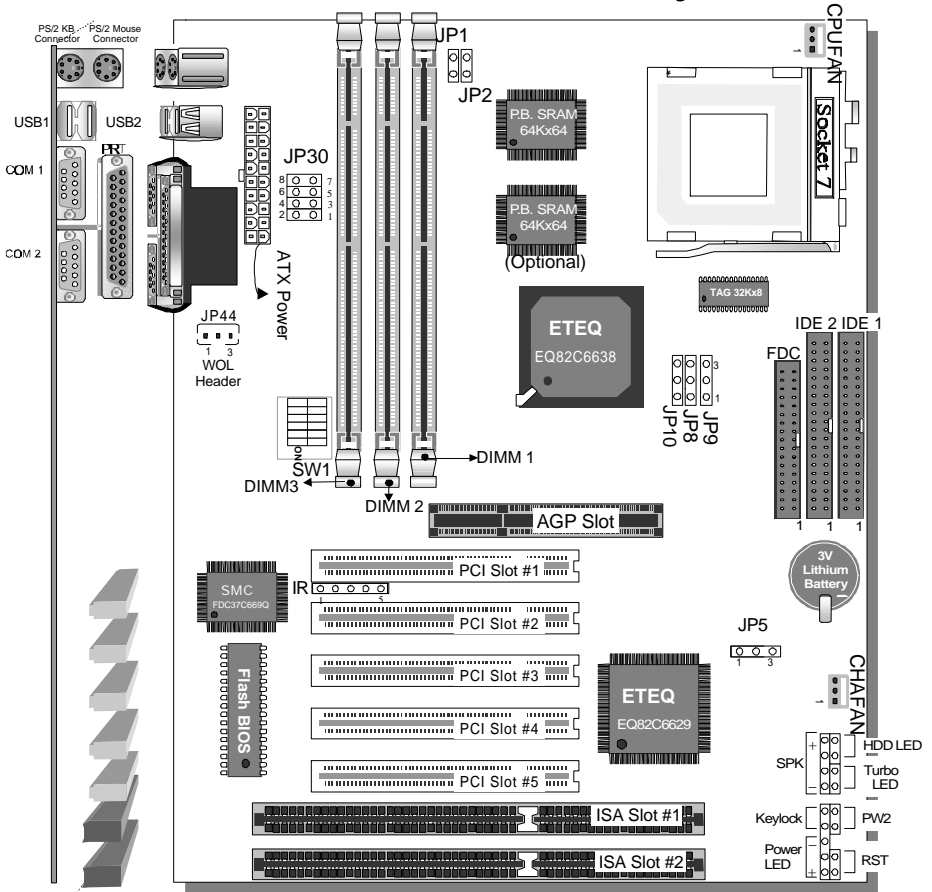

Back Panel

SY-5EMA+ Platform

Key Features

- Super 7™ Platform
- 512KByte/1MByte L2 cache
- Supports CPU voltage from 2.0v to 3.5v in 0.1v increments
- PC97, ACPI, Ultra DMA/33MHz
- Power-on by modem or alarm
- Supports Wake On LAN (WOL)
- Fan-off in Suspend mode
- 5x32-bit bus mastering PCI slots
- 2xUSB ports, 1xIrDA port
- Supports multiple-boot function
- DMI utility

## Chapter 1

### INTRODUCTION

The **SY-5EMA+** AGP/PCI Motherboard is a high-performance ATX form-factor system board. **SY-5EMA+** uses the ETEQ82C663 PCI Chipset technology and supports Pentium® class processors. This Motherboard is fully compatible with industry standards and adds many technical enhancements.

#### 1-1 KEY FEATURES

##### ● CPU

- Supports Intel Pentium Processor P54C/P55C series CPUs featuring speeds of 100-233 MHz
- Supports Cyrix 6x86/6x86L/6x86MX CPUs with PR150-PR266 speeds and Cyrix M II-300-350 CPU
- Supports AMD K5 CPUs running at PR100-PR166 speeds, AMD K6 CPUs running at speeds of 166-300 MHz speeds, and AMD K6-2 266-350 CPU
- Supports IDT Winchip C6/W2 200/225 CPUs
- Features Socket 7 for CPU easy upgrade
- Supports P54C/P55C series SIMM Mode and CPU Stop Clock

##### ● L2 Cache Controller

- On-board 512KB(SY-5EMA+/5) or 1MB (SY-5EMA+) Level 2 Pipeline Burst SRAM Cache

##### ● DRAM Controller

- Supports 3 strips of 168-pin SDRAM unbuffered DIMM  
3 x 168-pin DIMM banks support 8/16/32/64/128/256 MB unbuffered DIMM modules
- Memory configuration:
  - ◆ System memory: 8MB to 768MB with EDO/SDRAM

**SY-5EMA+ PLATFORM FEATURES**

Board Size	4-layer PCB, 19x30.5cm(7.5"x12"), ATX Form Factor
Socket 7	Socket for Pentium® class CPUs with Host Bus frequency of 66/100MH; Supports: <ul style="list-style-type: none"><li>➤ Intel Pentium® Processors P54C/P55C (100-233MHz)</li><li>➤ Cyrix 6x86™(PR166+-PR200+), Cyrix 6x86 MX™(PR166-PR266) and Cyrix M II™ (300~350)</li><li>➤ AMD K5™(PR100-PR166), and AMD K6™(166-300) and AMD K6™2 (266~350)</li><li>➤ IDT Winchip C6/W2 200/225</li></ul>
Chipset	ETE82C663 PCI/AGP Bus Chipset
ATX Power	20-pin Male Connector
CPUFAN	3-pin CPU Cooling Fan Connector
CHAFAN	3-pin Chassis Cooling Fan Connector
Memory	DIMM Bank (DIMM1 & DIMM2 & DIMM3) <ul style="list-style-type: none"><li>➤ 168-pin Unbuffered SDRAM DIMM Module</li><li>➤ Supports 8~256MB DIMM in each Bank</li><li>➤ Supports ECC configuration</li></ul>
BIOS	System BIOS built-in, Award BIOS <ul style="list-style-type: none"><li>➤ APM, ACPI and "Plug-and-Play" function</li><li>➤ Supports multiple-boot function</li><li>➤ DMI utility</li></ul>
PCI Slots	5 x 32-bit Bus Mastering Slots
ISA Slots	2 x 16-bit ISA Slots
IDE1, IDE2	2 x 40-pin Bus Mastering E-IDE/ATAPI Ports <ul style="list-style-type: none"><li>➤ IDE1: Primary IDE Device Connector</li><li>➤ IDE2: Secondary IDE Device Connector</li><li>➤ Supports Ultra DMA/33</li></ul>
FDC	1 Floppy Disk Drive (FDD) Port (Supports 1.2MB/1.44MB/2.88MB and LS120/3-mode FDD)
SIR	5-pin Serial Infrared Device Connector
Keylock	5-pin KeyLock Connector
Reset	2-pin Reset Switch Connector
Speaker	4-pin PC Speaker Connector
TB_LED	2-pin Turbo LED Connector
HDD_LED	2-pin IDE Device LED Connector
PWRBT	ATX Power On/Off Switch 2-pin Connector
JP5	CMOS Clear Jumper

JP8	CPU bus clock frequency Jumper
JP9, JP10	SDRAM frequency Jumpers
JP30	CPU Voltage Selection Jumper
JP44	WOL (Wake-On-LAN) 3-pin Connector
SW1	CPU frequency Settings Jumper

**BACK-PANEL FEATURES**

PRT	1 x Onboard 26-pin Female Parallel Printer Port
COM1, COM2	2 x Onboard RS-232 Serial Port
PS/2 KB	1 x Onboard PS/2 Keyboard Connector
PS/2 Mouse	1 x Onboard PS/2 Mouse Connector
USB1, USB2	2 x Onboard USB (Universal Serial Bus) Connectors

## 1-2 HANDLING THE MOTHERBOARD

To avoid damage to your Motherboard, follow these simple rules while unpacking:

- Before handling the Motherboard, ground yourself by grasping an unpainted portion of the system's metal chassis.
- Remove the Motherboard from its anti-static packaging. Hold the Motherboard by the edges and avoid touching its components.
- Check the Motherboard for damage. If any chip appears loose, press carefully to seat it firmly in its socket.



---

**Warning:** Do not apply power if the Motherboard appears damaged. If there is damage to the board, contact your dealer immediately.

---

## 1-3 ELECTROSTATIC DISCHARGE PRECAUTIONS

Make sure to ground yourself before handling the Motherboard or other system components. Electrostatic discharge can easily damage the components. Note that you must take special precautions when handling the Motherboard in dry or air-conditioned environment.

To protect your equipment from electrostatic discharge, take the following precautions:

- Do not remove the anti-static packaging until you are ready to install.
- Ground yourself before removing any system component from its protective anti-static packaging. (To ground yourself, grasp the expansion slot covers or other unpainted portions of the computer chassis.)
- Frequently ground yourself while working or use a grounding strap.



## Chapter 2

### HARDWARE SETUP

Congratulations on your purchase of **SY-5EMA+** Super 7™ Motherboard. You are about to install and connect your new Motherboard.



---

**Note:** Do not unpack the Motherboard from its protective anti-static packaging until you have made the following preparations.

---

#### 2-1 Preparations

Gather and prepare all the following hardware equipment to complete the installation successfully:

1. Pentium processor with CPU cooling fan.
2. DIMM memory module
3. Computer case and chassis with adequate power supply unit
4. Monitor
5. Keyboard
6. Pointing Device (PS/2 mouse)
7. Speaker(s) (optional)
8. Disk Drives: HDD, CD-ROM, Floppy drive ...
9. External Peripherals: Printer, Plotter, and Modem (optional)
10. Internal Peripherals: Modem and LAN cards (optional)

## 2-2 Unpacking the Motherboard

When unpacking the Motherboard, check for the following items:

- The **SY-5EMA+** ETEQ82C663 PCI/AGP Motherboard
- This *Quick Start Guide* \*
- The Installation CD-ROM \*
- One IDE Device Flat Cable
- One Floppy Disk Drive Flat Cable

\* If your board comes with a driver disc and a paper manual, the Quick Start Guide and the CD-ROM are not included in the package.



---

**Warning:** Do not unpack the Motherboard from its anti-static packaging until you are ready to install it.

---

Like most electronic equipment, your Motherboard may be damaged by electrostatic discharge. To avoid permanent damage to components ground yourself while working by using a grounding strap. Otherwise, ground yourself frequently by touching the unpainted portion of the computer chassis to drain the static charges.

Handle the Motherboard carefully, holding it by the edges. You are now ready to start the installation.

## 2-3 Installation Guide

We will now begin the installation of the Motherboard. Please follow the step-by-step procedure designed to lead you to a complete and correct installation.

### Step 1. CPU Installation

Follow these instructions to install your Pentium® class processor correctly.

Locate the CPU socket labeled Socket 7 on your Motherboard and note the distinctive pinhole arrangement.

Note the corresponding pinhole arrangement on the processor.

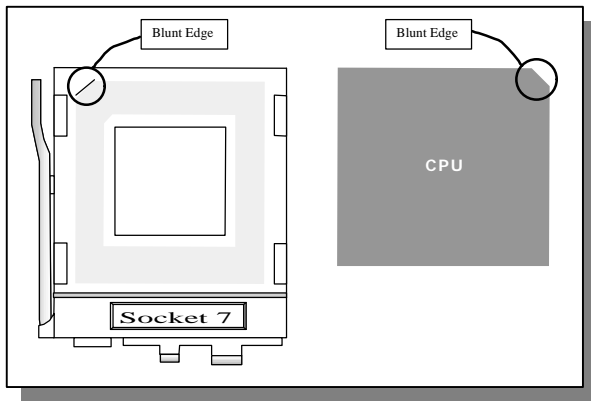

Follow these steps to install the CPU in the Socket 7:

1. Lift the socket handle up to a vertical position.
2. Align the blunt edge of the CPU with the matching pinhole distinctive edge on the socket.
3. Seat the processor in the socket completely and without forcing.
4. Then close the socket handle to secure the CPU in place.

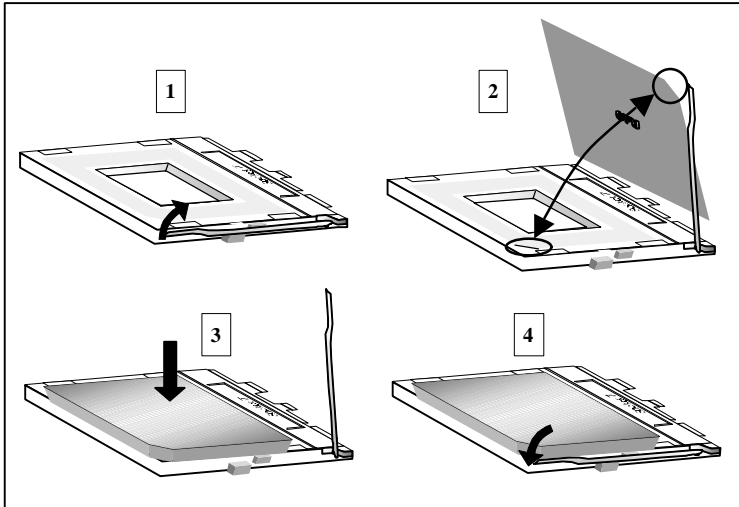

## Step 2. CPU Fan Installation

Your Pentium® processor kit comes with a cooling fan. Mount the fan on the processor according to the instructions provided by the manufacturer. The fan is a key component that will ensure system stability. The fan prevents overheating, therefore prolonging the life of your CPU.

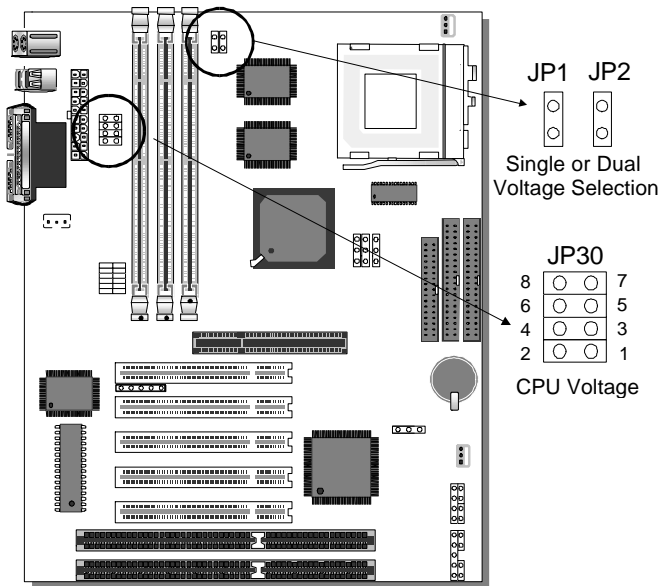

**Note:** Remember to connect the fan to the appropriate power source.

**Step 3. CPU Voltage Setting (JP30,JP1 and JP2)**

Please verify the correct voltage with your dealer before installation. Use the following tables to set JP30 to the proper "Voltage Value", according to the specifications marked on your CPU: This Motherboard comes with pre-configured setting of CPU voltage. However the voltage of your CPU maybe different with the default setting.

- **CPU VOLTAGE SETTING (JP30,JP1 and JP2)**

JP30 is used to set the CPU core voltage, JP1 and JP2 are used to select the CPU voltage type single voltage or dual voltage. There are two kinds of CPU voltages currently on the market depending on the CPU manufacturer:

- Single Voltage (CPU: P54C, AMD-K5, Cyrix 6x86, IDT Winchip C6/W2)
- Dual Voltage (CPU: P55C, AMD-K6, AMD-K6-2 Cyrix 6x86L, Cyrix 6x86MX, Cyrix M II)





Those processors may come in various voltages on different markets. Therefore, always make sure you know the type of the CPU you are installing and adjust the settings on JP30 accordingly.

This motherboard supports CPU core voltages from 2.0 to 3.5V in 0.1V increments. Use the following tables to set the CPU voltage jumpers JP30 to match the voltage value of your CPU:

**CPU Core Voltage Setting: JP30**

Voltage Value	1-2	3-4	5-6	7-8
3.5V	close	close	close	close
3.4V	open	close	close	close
3.3V	close	open	close	close
3.2V	open	open	close	close
3.1V	close	close	open	close
3.0V	open	close	open	close
2.9V	close	open	open	close
2.8V	open	open	open	close
2.7V	close	close	close	open
2.6V	open	close	close	open
2.5V	close	open	close	open
2.4V	open	open	close	open
2.3V	close	close	open	open
2.2V	open	close	open	open
2.1V	close	open	open	open
2.0V	open	open	open	open







**Single or Dual voltage selection: JP1 and JP2**

Voltage Type	JP1	JP2
<b>Single Voltage</b> (P54C, AMD-K5, Cyrix 6x86, IDT Winchip C6/W2)		
<b>Dual Voltage</b> (P55C, AMD-K6, AMD-K6-2, Cyrix 6x86L, Cyrix 6x86MX, Cyrix M II)		

Voltage Settings for Various Processors

Processor Voltage Setting	Voltage Value: JP30	JP1	JP2
Intel P54C - P100 Intel P54C - P133	Single Voltage V <sub>ORE</sub> :3.3V V <sub>I/O</sub> :3.3V		
Intel P54C - P166 Intel P54C - P200	Single Voltage V <sub>ORE</sub> :3.5V V <sub>I/O</sub> :3.5V		
Intel P55C - P166 Intel P55C - P200 Intel P55C - P233	Dual Voltage V <sub>ORE</sub> :2.8V V <sub>I/O</sub> :3.3V		
AMD K5 - PR100 AMD K5 - PR133 AMD K5 - PR166	Single Voltage V <sub>ORE</sub> :3.5V V <sub>I/O</sub> :3.5V		
AMD K6 166 AMD K6 200	Dual Voltage V <sub>ORE</sub> :2.9V V <sub>I/O</sub> :3.3V		
AMD K6 233	Dual Voltage V <sub>ORE</sub> :3.2V V <sub>I/O</sub> :3.3V		
AMD K6 266 AMD K6 300 AMD K6-2 266 AMD K6-2 300 AMD K6-2 333 AMD K6-2 350 AMD K6-2 380 AMD K6-2 400	Dual Voltage V <sub>ORE</sub> :2.2V V <sub>I/O</sub> :3.3V		

## Voltage Settings for Various Processors (continued)

Processor Voltage Setting	Voltage Value: JP30	JP1	JP2
AMD K6-2 450*	Dual Voltage V <sub>ORE</sub> :2.3 V <sub>I/O</sub> :3.3V		
Cyrix 6x86(L) PR166+ Cyrix 6x86(L) PR200+	The Cyrix 6x86(L) come in several versions with different voltages. Please ask your dealer for the correct voltage.		
Cyrix 6x86MX-PR166* Cyrix 6x86MX-PR200* Cyrix 6x86MX-PR233* Cyrix 6x86MX-PR266* Cyrix M II 300* Cyrix M II 333* Cyrix M II 350*	Dual Voltage V <sub>ORE</sub> :2.9V V <sub>I/O</sub> :3.3V		
IDT WinChip C6/W2-200 IDT WinChip C6/W2-225	Single Voltage V <sub>ORE</sub> :3.5V V <sub>I/O</sub> :3.5V		
* Set the proper CPU voltage according to the marking on the CPU.			



Step 4. CPU Frequency Setting (SW1)

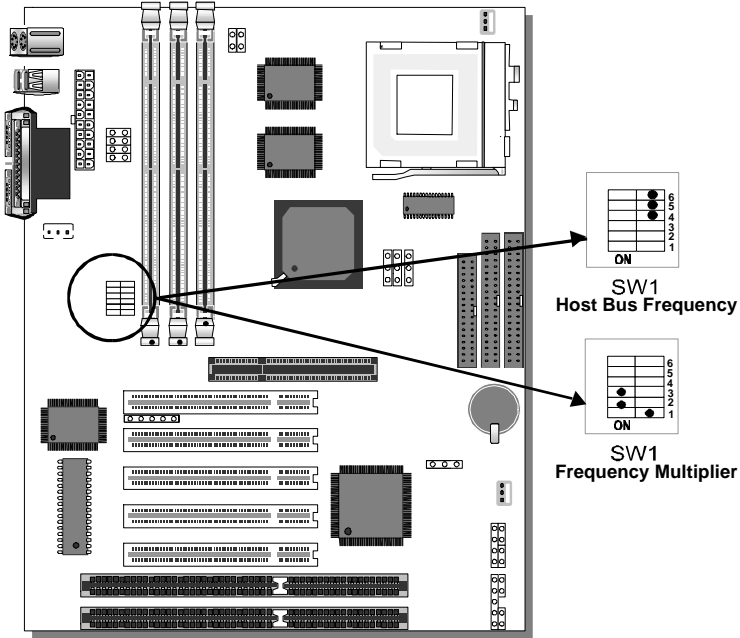

The SY-5EMA+ Motherboard is designed to support most Pentium® class processors currently on the market. Jumpers SW1 is used to configure the Motherboard frequency parameters to match the working frequency of your CPU.

● CPU FREQUENCY SETTING (SW1)

Configure the SW1 jumpers to the settings that match your CPU speed. Refer to the following tables to set the Frequency Multiplier and Host Bus Frequency of your CPU:

**Frequency Multiplier**

Multiplier	1	2	3
1.5/3.5x	off	off	off
2.0x*	on	off	off
2.5x	on	on	off
3.0x	off	on	off
4.0x	on	off	on
4.5x	on	on	on
5.0x	off	on	on

**Host Bus Frequency**

Host Bus Frequency	4	5	6
66MHz	off	off	off
75MHz	off	on	off
83MHz	on	on	off
95MHz	on	off	on
100MHz	off	off	on
112MHz	off	on	on
124MHz	on	off	off

**Example:** If the working frequency of your CPU is 133MHz, then select Multiplier=2.0x and Host Bus Frequency=66Mhz accordingly.

Also, as newer and higher frequency CPUs may not be listed in this section, please refer to the tables **CPU Frequency Settings for Various Processors** on page 8 for complementary information.

Please refer to the following table that gives you the correct frequency settings for the specific brand and model of CPU you are installing on this Motherboard.

**Frequency Settings for Intel® Processors**

Processor Frequency Setting	Ratio	Bus Clock	AGP Clock	PCI Clock	Frequency Setting: SW1
Intel P54C - P100	1.5 x	66MHz	66MHz	33MHz	
Intel P54C - P133	2.0 x	66MHz	66MHz	33MHz	
Intel P54C - P166	2.5 x	66MHz	66MHz	33MHz	
Intel P54C - P200	3.0 x	66MHz	66MHz	33MHz	
Intel P55C - P166	2.5 x	66MHz	66MHz	33MHz	
Intel P55C - P200	3.0 x	66MHz	66MHz	33MHz	
Intel P55C - P233	3.5 x	66MHz	66MHz	33MHz	

\* Set the proper CPU frequency according to the marking on the CPU.

## Frequency Settings for AMD™Processors

Processor Frequency Setting	Ratio	Bus Clock	AGP Clock	PCI Clock	Frequency Setting: SW1
AMD K5 - PR100	1.5 x	66MHz	66MHz	33MHz	
AMD K5 - PR133	2.0 x	66MHz	66MHz	33MHz	
AMD K5 - PR166	2.5 x	66MHz	66MHz	33MHz	
AMD K6 - 166	2.5 x	66MHz	66MHz	33MHz	
AMD K6 - 200	3.0 x	66MHz	66MHz	33MHz	
AMD K6 - 233	3.5 x	66MHz	66MHz	33MHz	
AMD K6 - 266	4.0 x	66MHz	66MHz	33MHz	
AMD K6 - 300	4.5 x	66MHz	66MHz	33MHz	
AMD K6-2 266	4.0 x	66MHz	66MHz	33MHz	
AMD K6-2 300	4.5 x	66MHz	66MHz	33MHz	
AMD K6-2 300	3.0 x	100MHz	66MHz	33MHz	
AMD K6-2 333	5.0 x	66MHz	63.4MHz	31.7MHz	
AMD K6-2 333	3.5 x	95MHz	63.4MHz	31.7MHz	

## Frequency Settings for AMD™Processors (Continued)

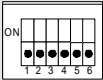
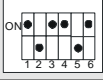
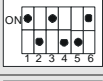
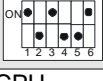
Processor Frequency Setting	Ratio	Bus Clock	AGP Clock	PCI Clock	Frequency Setting: SW1
AMD K6-2 350	3.5 x	100MHz	66MHz	33MHz	
AMD K6-2 380	4.0 x	95MHz	63.4MHz	31.7MHz	
AMD K6-2 400	4.0 x	100MHz	66MHz	33MHz	
AMD K6-2 450*	4.5 x	100MHz	66MHz	33MHz	

\* Set the proper CPU frequency according to the marking on the CPU.

## Frequency Settings for Cyrix™Processors

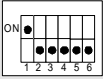
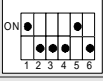
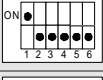
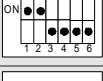
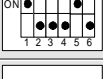
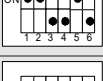
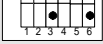
Processor Frequency Setting	Ratio	Bus Clock	AGP Clock	PCI Clock	Frequency Setting: SW1
Cyrix 6x86 - PR166+	2.0 x	66MHz	66MHz	33MHz	
Cyrix 6x86 - PR200+	2.0 x	75MHz	75MHz	37.5MHz	
Cyrix MX - PR166**	2.0 x	66MHz	66MHz	33MHz	
Cyrix MX - PR200**	2.5 x	66MHz	66MHz	33MHz	
Cyrix MX - PR200**	2.0 x	75MHz	75MHz	37.5MHz	
Cyrix MX - PR233**	2.5 x	75MHz	75MHz	37.5MHz	
Cyrix MX - PR266**	2.5 x	83MHz	55MHz	27.5MHz	

## Frequency Settings for Cyrix™Processors (Continued)

Processor Frequency Setting	Ratio	Bus Clock	AGP Clock	PCI Clock	Frequency Setting: SW1
Cyrix M II - 300**	3.5 x	66MHz	66MHz	33MHz	
Cyrix M II - 300**	3.0 x	75MHz	75MHz	37.5MHz	
Cyrix M II - 333**	4.0 x	66MHz	66MHz	33MHz	
Cyrix M II - 333**	3.5 x	75MHz	75MHz	37.5MHz	
Cyrix M II - 333**	3.0 x	83MHz	55MHz	27.5MHz	
Cyrix M II - 333**	2.5 x	100MHz	66MHz	33MHz	
Cyrix M II - 350**	3.0 x	100MHz	66MHz	33MHz	

\*\* Set the proper CPU frequency according to the marking on the CPU.  
Over specification is not guaranteed.

## Frequency Settings for IDT™Processors

Processor Frequency Setting	Ratio	Bus Clock	AGP Clock	PCI Clock	Frequency Setting: SW1
IDT WinChip C6/W2-200	3.0 x	66MHz	66MHz	33MHz	
IDT WinChip C6/W2-225	3.0 x	75MHz	75MHz	37.5MHz	

\*\* Set the proper CPU frequency according to the marking on the CPU.  
Over specification is not guaranteed.

**Step 5. Set JP8,JP9,JP10 for SDRAM frequency**

JP8 is used to indicate the frequency of the CPU bus clock to the ETEQ chipset.

JP9 and JP10 are used to determine that the SDRAM is running at the frequency of the CPU bus clock or the AGP clock.

CPU BUS Clock	AGP BUS Clock	JP10	JP8	JP9	SDRAM Clock
66MHz	66MHz	1-2	2-3	2-3	66MHz
75MHz	75MHz	1-2	2-3	2-3	75MHz
83MHz	55MHz	2-3	1-2	1-2	55MHz
		1-2	1-2	2-3	83MHz
95MHz	63.4MHz	2-3	1-2	1-2	63.4MHz
		1-2	1-2	2-3	95MHz
100MHz	66MHz	2-3	1-2	1-2	66MHz
		1-2	1-2	2-3	100MHz
112MHz	75MHz	2-3	1-2	1-2	75MHz
		1-2	1-2	2-3	112MHz
124MHz	82.6MHz	2-3	1-2	1-2	82.6MHz
		1-2	1-2	2-3	124MHz

*Note: Use 8ns or faster SDRAM modules (PC100 compliant) when SDRAM is set to run at the frequency of 95/100 MHz.*

**Step 6. DRAM Module Installation**

This Motherboard supports three DIMM banks from 8 to 256 MB with no other restrictions on memory configurations. You can install the memory in any combination without having to rely on a memory configuration table. Memory configuration is therefore "table-free" in any memory bank.

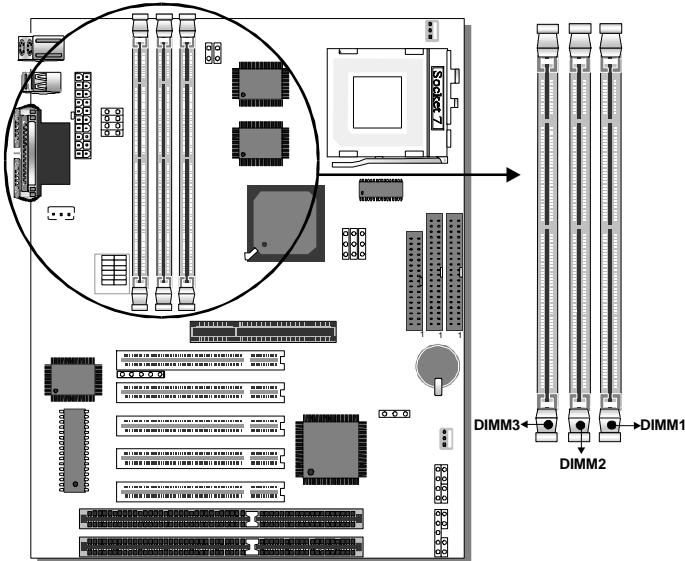

This Motherboard supports both EDO and SDRAM types of memory modules.

**Note:**

Do not install EDO type of DIMM modules if you already use SDRAM in any DIMM bank..



## ● MEMORY CONFIGURATION

This Motherboard features 3 x DIMM Banks for 168-pin 3.3V unbuffered DIMM modules

Your board comes with three DIMM sockets, providing support for up to 768MB of main memory using DIMM modules from 8MB to 256MB. For 66MHz host bus CPUs use 12ns or faster DIMM modules; for 83MHz or faster host bus CPUs use 8ns modules.

### Memory configuration Table

MEMORY CONFIGURATION	DIMM Banks		
	DIMM 1	DIMM 2	DIMM 3
RAM Type	EDO/SDRAM	EDO/SDRAM	EDO/SDRAM
Single RAM Module Size (MB)	8/16/32/64/128/256	8/16/32/64/128/256	8/16/32/64/128/256
<b>Notice: Do not use EDO type of DIMM if you already use SDRAM.</b>			

### Step 7. IDE Device Installation (HDD, CD-ROM)

This Motherboard offers two primary and secondary IDE device connectors (IDE1, IDE2.) It can support up to four high-speed HDD or CD-ROM.

Connect one side of the 40-pin flat cable to the IDE device (HDD or CD-ROM) and plug the other end to the primary (IDE1) or secondary (IDE2) directionally keyed IDE connector on the Motherboard.

This Motherboard can support up to four HDDs.

### Step 8. Floppy Drive Installation

The system supports 5 possible floppy drive types: 720 KB, 1.2 MB, 1.44 MB, 2.88 MB, and LS-120. In addition, this Motherboard supports a 3-mode (720KB/1.25MB/1.44MB) floppy commonly used in Japan.

Connect one side of the 34-pin flat cable to the floppy drive and plug the other end to the floppy drive connector on the Motherboard.

This Motherboard can support up to 2 floppy drives.

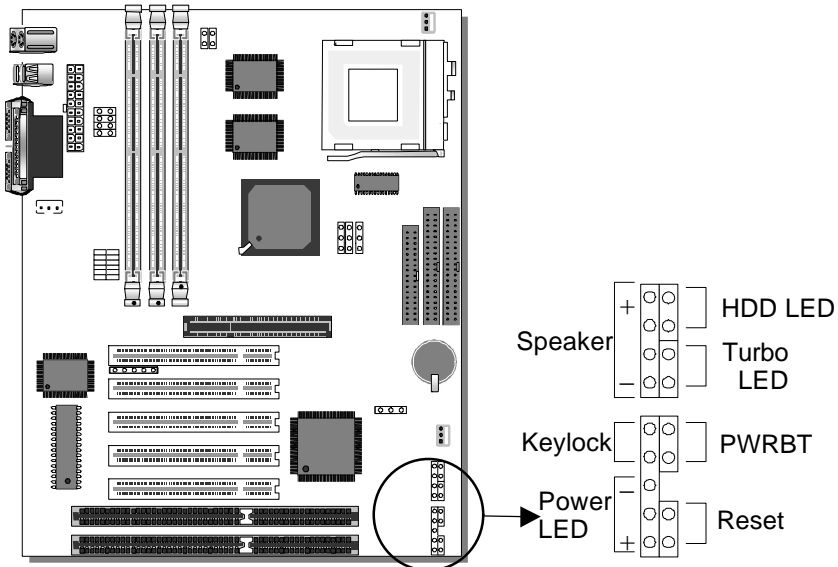
**Step 9. Front Panel Connections**

Plug the computer case's front panel devices to the corresponding connectors on the Motherboard.

**1. Power LED & KeyLock**

Plug the Power LED cable into the 5-pin Keylock connector.

Some systems may feature a KeyLock function with a front panel switch for enabling or disabling the keyboard. Connect the KeyLock switch to the 5-pin Keylock connector on the Motherboard.

Please install according to the following pin assignment: pin 1,3 are for Power LED and pin 4,5 are for Keylock.

**2. Reset**

Plug the Reset push-button cable into the 2-pin Reset connector on the Motherboard. Pushing the Reset button on the front panel will cause the system to restart the boot-up sequence.

**3. Speaker**

Attach the 4-pin PC speaker cable from the case to the Speaker connector on the Motherboard.

**4. Turbo LED**

Connecting the 2-pin Turbo LED cable to the corresponding Turbo LED connector will cause the LED to light whenever the system is in Turbo mode.

The manufacturer has permanently set this Motherboard in Turbo mode due to most hardware and software compliance to turbo mode.

**5. IDE LED**

Attach the 2-pin IDE device LED cable to the corresponding IDE LED connector on the Motherboard. This will cause the LED to lighten when an IDE (HDD, CD-ROM) device is active.

**6. ATX Power On/Off Switch**

Attach the 2-pin momentary type switch to the PWRBT connector for turning On or Off your ATX power supply.

### Step 10. Back Panel Connections

All external devices such as the keyboard, printer, PS/2 mouse, modem, USB, can be plugged directly onto the Motherboard back panel.

Only after you have fixed and locked the Motherboard to the computer case can you start connecting the external peripheral devices.

When connecting an external device, use the following figure to locate and identify which back panel connector to plug the device to.

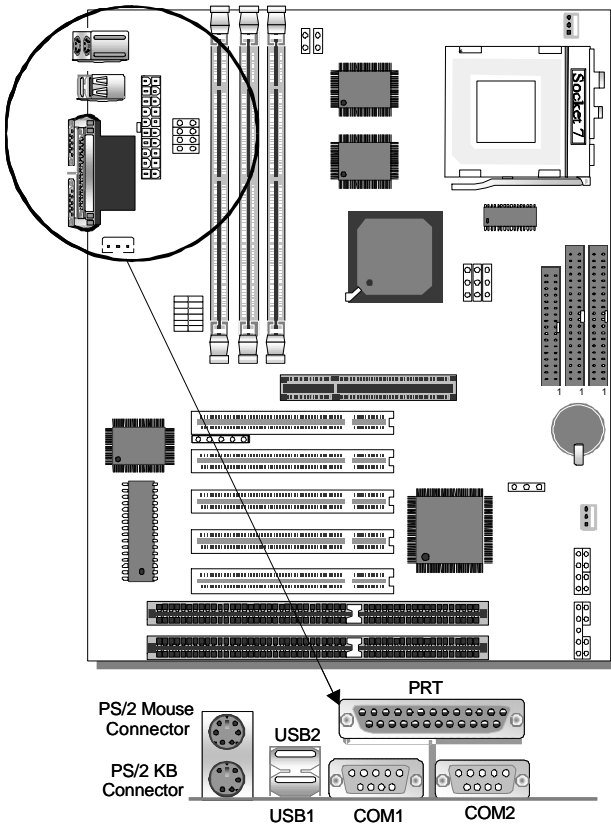

**1. Onboard Serial Port COM1,COM2**

External peripherals that use serial transmission scheme include:

- serial mouse,
- and modem.

Plug the serial device cables directly into the COM1 or COM2 9-pin male connector located at the rear panel of the Motherboard.

**2. Parallel Port PRT**

This parallel port is used to connect the printer or other parallel devices.

Plug the parallel device cable into the 26-pin female connector located at the rear panel of the Motherboard.

**3. PS/2 Keyboard**

Plug the keyboard jack directly into the 6-pin female PS/2 keyboard connector located at the rear panel of the Motherboard.

**4. PS/2 Mouse**

Similarly, plug the mouse jack directly into the 6-pin female PS/2 mouse connector.

**5. Universal Serial Bus USB1/USB2**

This Motherboard provides two USB ports for your additional devices. Plug the USB device jack into the available USB connector USB1 or USB2.

- USB devices under Win98 are allowed.
- With Win95, use the flow HCI V1.1 specifications.

## 1. Wake-On-LAN (WOL)

Attach the 3-pin connector from the LAN card which supports the Wake-On-LAN (WOL) function to the JP44 connector on the Motherboard. This WOL function lets users wake up the connected computer through the LAN card.

Please install according to the following pin assignment:

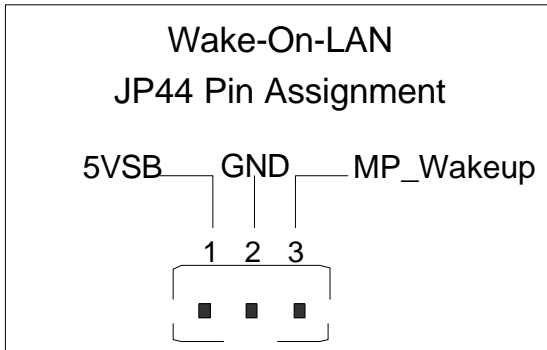

## 2. Infrared (IR)

Plug the 5-pin infrared device cable to the IR connector. This will enable the infrared transfer function. This Motherboard meets both the ASKIR and HPSIR specifications.

Please install according to the following pin assignment:

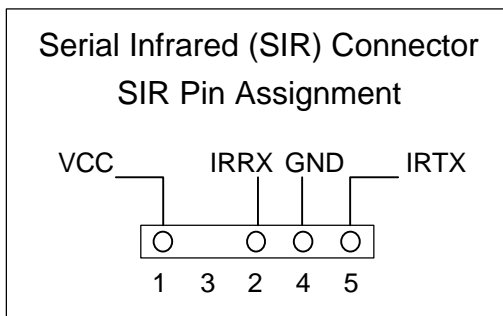

**Step 11. CPU Cooling Fan Installation**

After you have seated the CPU cooling fan properly on the processor, attach the 3-pin fan cable to the CPUFAN connector on the Motherboard.

To avoid damage to the system, install according to the following pin assignment:

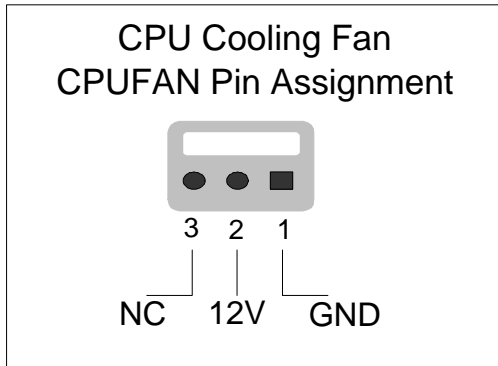

**Step 12. Chassis Cooling Fan Installation**

After you have seated the Chassis cooling fan properly on the processor, attach the 3-pin fan cable to the CHAFAN connector on the Motherboard.

To avoid damage to the system, install according to the following pin assignment:

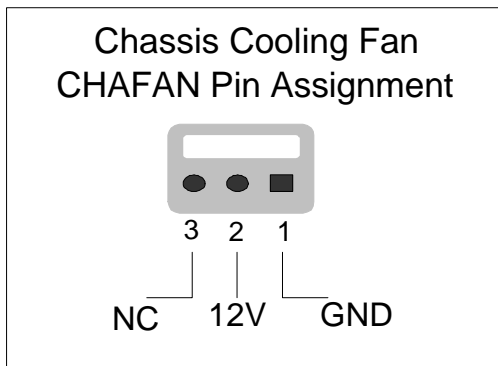

**Step 13. ATX Power Supply**

Plug the connector from the power directly into the 20-pin male ATX PW connector on the Motherboard, as shown in the following figure.

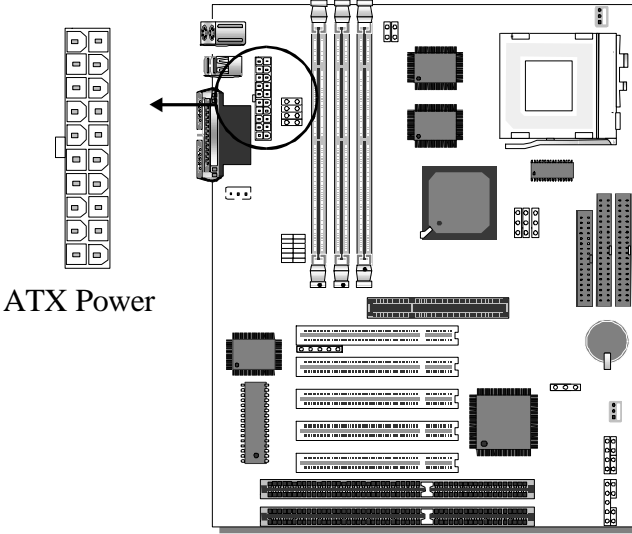

---

**Warning:** Follow these precautions to preserve your Motherboard from any remnant currents when connecting to ATX power supply:



**Turn off the power supply and unplug the power cord of the ATX power supply before connecting to ATX PW connector.**

---

The Motherboard requires a power supply with at least 200 Watts and a "power good" signal. Make sure the ATX power supply can take at least 10 mA mp\* load on the 5V Standby lead (5VSB) to meet the standard ATX specification.

\* **Note:** If you use the Wake-On-LAN (WOL) function, make sure the ATX power supply can support at least 720 mAmp on the 5V Standby lead (5VSB).



Please install the ATX power according to the following pin assignment:

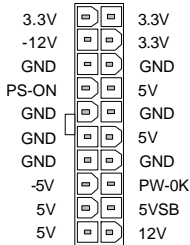

ATX Power



➤ **Pay special care to the directionality.**

**Step 14. CMOS Clearing (JP5)**

After you have turned off your computer, clear the CMOS memory by momentarily shorting pins 2-3 on jumper JP5, for a few seconds. Then restore JP5 to the initial 1-2 jumper setting in order to recover and retain the default settings.

CMOS Clearing	Clear CMOS Data	Retain CMOS Data (Default)
<b>JP5 Setting</b>	Short pin 2-3 for a few seconds to clear the CMOS 	Short pin 1-2 to retain new settings 
<b>Note:</b> You must unplug the ATX power cable from the ATX power connector when performing the CMOS Clear operation.		

**Step 15. MULTI I/O ADDRESSES**

Default settings for multi-I/O addresses are as follows:

Port	I/O Address	IRQ	Status
LPT1	378H	7	ECP + EPP
COM1	3F8H	4	
COM2	2F8H	3	



**Warning:** If a default I/O address conflicts with other I/O cards such as sound card, you must change one of the I/O addresses to remedy to this address conflict. (I/O addresses can be adjusted from the BIOS Setup Utility)

**Step 16. CACHE CONFIGURATION**

This Motherboard has a built-in 512KB(SY-5EMA+/5) or 1MB(SY-5EMA+) Level 2 Pipelined Burst cache onboard to improve the system performance.

The cache size and RAM locations are specified as follows:

Cache Size	Cache RAM	TAG RAM	Cacheable Range
1 MB	64K x 64 on U2, U3	32K x 8 on U5	WT: 256 MB WB: 128MB
512 KB	64K x 64 on U2	32K x 8 on U5	WT: 128 MB WB: 64 MB

**Step 17. Power On**

You have now completed the hardware installation of your Motherboard successfully.

1. Turn the power on
2. To enter the BIOS Setup Utility, press the <DEL> key while the system is performing the diagnostic checks,



**Note:** If you have failed to enter the BIOS, wait until the boot up sequence is completed. Then push the RESET button and press <DEL> key again at the beginning of boot-up, during diagnostic checks.

Repeat this operation until you get the following screen.

3. The BIOS Setup screen appears:

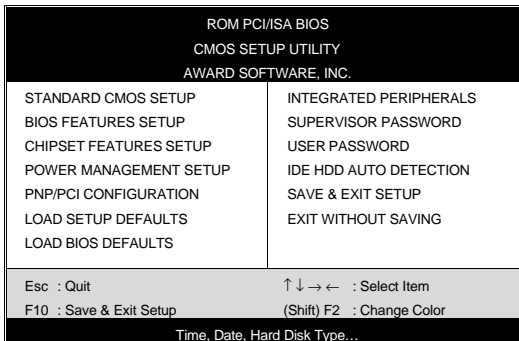

You are now ready to configure your system with the BIOS setup program. Go to Chapter 3: **BIOS SETUP**

## Chapter 3

# BIOS SETUP UTILITY

This Motherboard's BIOS setup program uses the ROM PCI/ISA BIOS program from Award Software Inc.

To enter the Award BIOS program's Main Menu:

1. Turn on or reboot the system.
2. After the diagnostic checks, press the [Del] key to enter the Award BIOS Setup Utility.

ROM PCI/ISA BIOS CMOS SETUP UTILITY AWARD SOFTWARE, INC.	
STANDARD CMOS SETUP BIOS FEATURES SETUP CHIPSET FEATURES SETUP POWER MANAGEMENT SETUP PNP/PCI CONFIGURATION LOAD SETUP DEFAULTS LOAD BIOS DEFAULTS	INTEGRATED PERIPHERALS SUPERVISOR PASSWORD USER PASSWORD IDE HDD AUTO DETECTION SAVE & EXIT SETUP EXIT WITHOUT SAVING
Esc : Quit <span style="float: right;">↑↓→← : Select Item</span> F10 : Save & Exit Setup <span style="float: right;">(Shift) F2 : Change Color</span>	
Time, Date, Hard Disk Type...	

### Selecting items

- Use the arrow keys to move between items and select fields.
- From the Main Menu press arrow keys to enter the selected submenu.

### Modifying selected items

- Use the [Up]/[Down] keys to modify values within the selected fields. Some fields let you enter values directly.

**Hot Keys:** Function keys give you access to a group of commands throughout the BIOS utility.

Function	Command	Description
F1	Help	Gives the list of options available for each item.
Shift F2	Color	Change the color of the display window.
F5	Old values	Restore the old values. These are the values that the user started the current session with.
F6	Load BIOS Defaults	Loads all options with the BIOS Setup default values.
F7	Load Setup Defaults	Loads all options with the Power-On default values.
F10	Save & Exit Setup	Saves your changes and reboots the system.
[Esc]	Quit	Lets you return at anytime and from any location to the Main Menu.

**SAVE AND EXIT SETUP**

Select the [SAVE & EXIT SETUP] option from the Main Menu to save data to CMOS and exit the setup utility. This option saves all your changes and causes the system to reboot.

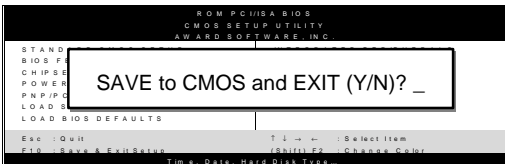

Type [Y] to save the changes and exit or [N] to return to the Main Menu and keep current values.

**EXIT WITHOUT SAVING**

Selecting the [EXIT WITHOUT SAVING] option allows you to abandon all data and exit setup, therefore ignoring all your changes.

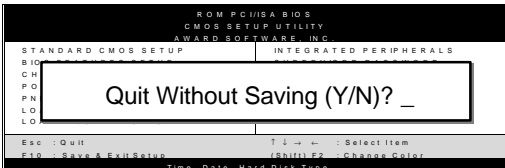

Type [Y] to abandon changes and exit or [N] to return to the Main Menu and keep current values.

### 3-1 STANDARD CMOS SETUP

Select the [STANDARD CMOS SETUP] option from the Main Menu and press [Enter] key.

ROM PCI/ISA BIOS							
STANDARD CMOS SETUP							
AWARD SOFTWARE, INC.							
Date (mm:dd:yy)	:	Fri, May 29 1998					
Time (hh:mm:ss)	:	9 : 42 : 43					
HARD DISKS	TYPE	SIZE	CYLS	HEAD	PRECOMP	LANDZ	SECTOR MODE
Primary Master	: AUTO	0	0	0	0	0	0 AUTO
Primary Slave	: None	0	0	0	0	0	0 ----
Secondary Master	: None	0	0	0	0	0	0 ----
Secondary Slave	: None	0	0	0	0	0	0 ----
Drive A : 1.44M, 3.5 in.							
Drive B : None							
Floppy 3 Mode Support : Disabled							
Video : EGA/VGA							
Halt On : All Errors							
						Base Memory:	640K
						Extended Memory:	3328K
						Other Memory:	128K
						Total Memory:	4096K
Esc : Quit		↑ ↓ → ←	: Select Item		PU/PD/+/-	: Modify	
F1 : Help		(Shift) F2	: Change Color		F3	: Toggle Calendar	

This screen allows you to modify the basic CMOS settings.

After you have completed the changes, press [Esc] key to return to the Main Menu.

#### 3-1.1 Date & Time

	Display	Setting	Please Note
Date	mm/dd/yyyy	Type the current date	You can also the PUp/PDn keys to toggle
Time	hh:mm:ss	Type the current time	24-hour clock format 3:15 PM is displayed as 15:15:00

### 3-1.2 Hard Disks Type & Mode

Choose the type and mode for the hard disks that you have already installed.

Primary (Secondary) Master & Slave	Setting	Description	Note
<b>Type</b>	Auto	BIOS detects hard disk type automatically.	Default
	1-47	Selects standard hard disk type.	
	User	User defines the type of hard disk.	
<b>Mode</b>	Auto	BIOS detects hard disk mode automatically.	Default
	Normal	Normal IDE hard disk	<528MB
	LBA	Enhanced IDE hard disk	>528MB
	Large	Large IDE hard disk (for certain hard disk)	



**Note:** If you have any questions on your hard disk type or mode, ask your hard disk provider or previous user for details.

### 3-1.3 Floppy Drives

Floppy Drives	Setting	Description	Note
<b>Drives A &amp; B</b>	360KB, 5.25 in.		
	1.2MB, 5.25 in.		
	720KB, 3.5 in.		
	1.44MB, 3.5 in.		Default
	2.88MB, 3.5 in.		
	None	Not installed	
<b>Floppy 3-Mode Support</b>	Disabled		Default
	Drive A Drive B Both	Supports 3-mode floppy diskette: 740KB/1.25MB/1.44MB on selected disk drive.	Special disk drive commonly used in Japan

**3-1.4 Video**

Select the video mode: EGA/VGA (Default), CGA 40, CGA 80, Mono (Monochrome).

**3-1.5 Halt On**

When the BIOS detects system errors, this function will stop the system. Select which type of error will cause the system halt: All Errors (Default), No Errors, All But Diskette, All But Keyboard, All But Disk/Key.



### 3-2 BIOS FEATURES SETUP

Select the [BIOS FEATURES SETUP] option from the Main Menu and press [Enter] key.

ROM PCI/ISA BIOS		
BIOS FEATURES SETUP		
AWARD SOFTWARE, INC.		
Virus Warning	: Disabled	Video BIOS Shadow : Enabled
CPU Internal Cache	: Enabled	C8000-CBFFF Shadow : Disabled
External Cache	: Enabled	CC000-CFFFF Shadow : Disabled
Quick Power On Self Test	: Enabled	D0000-D3FFF Shadow : Disabled
Boot Sequence	: A, C, SCSI	D4000-D7FFF Shadow : Disabled
Swap Floppy Drive	: Disabled	D8000-DBFFF Shadow : Disabled
Boot Up NumLock Status	: On	DC000-DFFFF Shadow : Disabled
Gate A20 Option	: Fast	
Memory Parity /ECC Check	: Enabled	
Typematic Rate Setting	: Disabled	
Typematic Rate (Chars/Sec)	: 6	
Typematic Delay (Msec)	: 250	
Security Option	: Setup	ESC : Quit                   ↑↓→← : Select Item
IDE Second Channel Control	: Enable	F1 : Help                    PU/PD/+/- : Modify
PCI/VGA Palette Snoop	: Disabled	F5 : Old Values       (Shift) F2 : Color
OS Select For DRAM > 64MB	: Non-OS2	F6 : Load BIOS Defaults
Report No FDD For WIN 95	: No	F7 : Load Setup Defaults

After you have completed the changes, press [Esc] key and follow the instructions on your screen to save your settings or exit without saving.

**3-2.1 Virus Warning**

	<b>Setting</b>	<b>Description</b>	<b>Note</b>
<b>Virus Warning</b>	Disabled		Default
	Enabled	Enable this option to protect the boot sectors and partition tables of your hard disk. Any attempt to write to them will the system to halt and display a warning message.	

**3-2.2 Cache Memory Options**

	<b>Setting</b>	<b>Description</b>	<b>Note</b>
<b>CPU Internal Cache</b>	Disabled		
	Enabled	Enables the CPU's internal cache.	Default
<b>External Cache</b>	Disabled		
	Enabled	Enables the external memory.	Default

3-2.3 System Boot Control Settings

System Boot Control Settings	Setting	Description	Note
<b>Quick Power On Self Test</b>	Disabled		
	Enabled	Provides a fast POTS at boot-up.	Default
<b>Boot Sequence</b>	A, C, SCSI	Choose the boot sequence adapted to your needs, for example: <ul style="list-style-type: none"> <li>• [A, C, SCSI] means the BIOS will look for an operating system first in drive A, then in drive C, and eventually in SCSI device.</li> </ul>	
	C, A, SCSI		
	C, CD-ROM, A		
	CD-ROM, C, A		
	D, A, SCSI		
	E, A, SCSI		
	F, A, SCSI		
	SCSI, A, C		
	SCSI, C, A		
	C only		
LS/ZIP, C			
<b>Swap Floppy Drive</b>	Disabled		Default
	Enabled	Changes the sequence of A and B drives.	
<b>Boot Up NumLock Status</b>	On	Puts numeric keypad in NumLock mode at boot-up.	Default
	Off	Puts numeric keypad in arrow key mode at boot-up.	

**System Boot Control Settings (continued)**

System Boot Control Settings	Setting	Description	Note
<b>Gate A20 Option</b>	Normal		
	Fast	Allows RAM access above 1MB using the fast gate A20 line.	Default
<b>Memory Parity Check/ ECC Check</b>	Enabled	This allows to perform a redundancy check on the parity bit in the data strings. This method is used for error detection when the parity is not found.	Default
	Disabled		

**3-2.4 Typematic Settings**

Typematic Settings	Setting	Description	Note
<b>Typematic Rate Setting</b>	Disabled		Default
	Enabled	Enables to adjust the keystroke repeat rate.	
The following [Typematic Rate] and [Typematic Delay] fields are active only if [Typematic Rate Setting] is set to [Enabled]			
<b>Typematic Rate (Chars/Sec)</b>	6 (Char/sec)	Choose the rate at which a character is repeated when holding down a key.	Default
	8 (Char/sec)		
	10 (Char/sec)		
	12 (Char/sec)		
	15 (Char/sec)		
	20 (Char/sec)		
24 (Char/sec)			
30 (Char/sec)			
<b>Typematic Delay (Msec)</b>	250 (msec)	Choose how long after you press a key down the character begins repeating.	Default
	500 (msec)		
	750 (msec)		
	1000 (msec)		

3-2.5 Other Control Options

Other Control Options	Setting	Description	Note
<b>Security Option</b>	Setup	Use this feature to prevent Unauthorized system boot-up or use of BIOS Setup. "Setup", If a password is set, the password prompt only appears if you attempt to enter the Setup program.	Default
	System	Each time the system is booted the password prompt appears.	
<b>IDE Second Channel Control</b>	Disabled	Turn off the on-board IDE.	
	Enabled	Use a PS/2 mouse.	Default
<b>PCI/VGA Palette Snoop</b>	Disabled		Default
	Enabled	The color of the monitor may be altered when using an MPEG card. Enable this option to restore the monitor's normal color.	
<b>OS Select for DRAM&gt;64MB</b>	OS2	When using an OS2 operating system.	
	Non-OS2	When using another, non-OS2 operating system.	Default
<b>Report No FDD For WIN 95</b>	No	Windows will reserve INT 6 for your FDD, whether it is Disabled or not.	Default
	Yes	Windows will release IRQ line 6 (normally used by the Floppy Disk Drive) after you disable you on-board FDD and set this field to [Yes].	

**Other Control Options (Continued)**

<b>Other Control Options</b>	<b>Setting</b>	<b>Description</b>	<b>Note</b>
<b>Video or Adapter BIOS Shadow</b>	Disabled		
	Enabled	The BIOS is shadowed in a 16K segment if it is enabled and if it has BIOS present. These 16 segments can be shadowed from ROM to RAM. BIOS shadow copies BIOS code from slower ROM to faster RAM. BIOS can then execute from RAM.	Default

### 3-3 CHIPSET FEATURES SETUP



**Caution:** Change these settings only if you are already familiar with the Chipset.

The [CHIPSET FEATURES SETUP] option changes the values of the chipset registers. These registers control the system options in the computer.

ROM PCI/ISA BIOS	
CHIPSET FEATURES SETUP	
AWARD SOFTWARE, INC.	
DIMM 1 DRAM Timing	: FP/EDO/70ns
DIMM 2 DRAM Timing	: FP/EDO/70ns
DIMM 3 DRMA Timing	: FP/EDO/70ns
DRAM Read Pipeline	: Enabled
Cache Rd+ CPU Wt Pipeline	: Disabled
Linear Burst	: Disabled
Video BIOS Cacheable	: Enabled
System BIOS Cacheable	: Enabled
Memory Hole At 15Mb Addr.	: Disabled
AGP Aperture Size	: 64M
AGP -2x Mode	: Disabled
On Chip USB	: Enable
USB Keyboard Support	: Disabled
Spread Spectrum Modulated	: Disabled
ESC : Quit                    ↑ ↓ → ← : Select Item F1 : Help                    PU/PD/+/- : Modify F5 : Old Values            (Shift) F2 : Color F6 : Load BIOS Defaults F7 : Load Setup Defaults	

After you have completed the changes, press [Esc] and follow the instructions on your screen to save your settings or exit without saving.

The following table describes each field in the CHIPSET FEATURES SETUP Menu and how to configure each parameter.

**CHIPSET FEATURES SETUP**

<b>CHIPSET FEATURES</b>	<b>Setting</b>	<b>Description</b>	<b>Note</b>
<b>DIMM 1 DRAM Timing</b>	FP/EDO 70ns	Use the default setting	Default
<b>DIMM 2 DRAM Timing</b>	Normal	Choose DRAM Timing.	
<b>DIMM 3 DRAM Timing</b>	Medium		
	Fast, Turbo		
<b>DRAM Read Pipeline</b>	Disabled		
	Enabled	Enhances system performance	Default
<b>Cache Rd+CPU Wt Pipeline</b>	Disabled		
	Enabled	Enhances system performance	Default
<b>Cache Timing</b>	Fast	Enhances system performance	Default
	Fastest		
<b>Linear Burst</b>	Disabled	Use the default setting	Default
	Enabled	Linear mode SRAM support for Cyrix type of CPU.	
<b>Video BIOS Cacheable</b>	Disabled		
	Enabled	The ROM area A0000-BFFFF is cacheable.	Default
<b>System BIOS Cacheable</b>	Disabled		
	Enabled	The ROM area F0000H-FFFFFFH is cacheable	Default
<b>Memory Hole 15Mb Addr.</b>	Disabled	Some interface cards will map their ROM address to this area.	Default
	Enabled		



**CHIPSET FEATURES SETUP (Continued)**

<b>CHIPSET FEATURES</b>	<b>Setting</b>	<b>Description</b>	<b>Note</b>
<b>AGP Aperture Size</b>	64M	AGP could use the DRAM as its video RAM. Choose the JDRAM size that you wish to allocate as video RAM.	Default
	4-256M		
<b>AGP-2X Mode</b>	Disabled		Default
	Enabled	Enable only if your AGP card supports 2x mode (faster)	
<b>OnChip USB</b>	Disabled		
	Enabled	Enable if you use a separate USB controller card	Default
<b>USB Keyboard Support</b>	Disabled		Default
	Enabled	Enabled if you use an USB Keyboard.	
<b>Spread Spectrum Modulated</b>	Disabled	Use the default setting	Default
	Enabled	When using Spread Spectrum Modulated 1.5% or 6% for FCC or DOC testing.	

### 3-4 POWER MANAGEMENT SETUP

The [POWER MANAGEMENT SETUP] sets the system's power saving functions.

ROM PCI/ISA BIOS			
POWER MANAGEMENT SETUP			
AWARD SOFTWARE, INC.			
ACPI function	: Disabled	Primary INTR	: ON
Power Management	: User Define	IRQ3 (COM2)	: Primary
PM Control by APM	: Yes	IRQ4 (COM1)	: Primary
Video Off Option	: Suspend ->Off	IRQ5 (LPT2)	: Primary
Video Off Method	: V/H SYNC+ Blank	IRQ6 (Floppy Disk)	: Primary
Modem Use IRQ	: 3	IRQ7 (LPT1)	: Primary
Sof-Off by PWR-BTTN	: Instant - Off	IRQ8 (RTC Alarm)	: Disabled
** PM Timers **		IRQ9 (IRQ2 Redir)	: Secondary
HDD Power Down	: Disabled	IRQ10 (Reserved)	: Secondary
Doze Mode	: Disabled	IRQ11 (Reserved)	: Secondary
Suspend Mode	: Disabled	IRQ12 (PS/2 Mouse)	: Primary
** PM Events **		IRQ13 (Coprocessor)	: Primary
VGA	: OFF	IRQ14 (Hard Disk)	: Primary
LPT & COM	: LPT/COM	IRQ15 (Reserved)	: Disabled
HDD & FDD	: ON	ESC : Quit                    ↑ ↓ → ← : Select Item F1 : Help                    PU/PD/+/- : Modify F5 : Old Values    (Shift) F2 : Color F6 : Load BIOS Defaults F7 : Load Setup Defaults	
DMA/ master	: OFF		
Modem Ring Resume	: Disabled		
RTC Alarm Resume	: Disabled		

After you have completed the Power Management Setup, press [Esc] to return to the Main Menu.

3-4.1 Power Management Controls

Power Management Controls	Setting	Description	Note
ACPI function	Disabled		Default
	Enabled	Enabled if you use Windows 98 and want to use ACPI	
Power Management	User Define	Lets you define the HDD and system power down times.	
		Doze timer    Standby timer    Suspend timer	
	Min Saving	40 Min    40 Min    40 Min	
	Max Saving	20 Sec    20 Sec    20 Sec	
PM Control by APM	Yes	To use Advanced Power Management (APM) you must run [power.exe] under DOS V6.0 or later version.	Default
	No		
Video Off Option	Suspend ->Off	The monitor will be switched off in suspend mode,	Default
	All Modes ->Off	the monitor will be switched off in all power saving modes	
	Always On		
Video Off Method	V/H SYNC+Blank	Selects the method by which the monitor is blanked.	Default
	Blank screen		
	DPMS Supported		
Modem Use IRQ	3	Assigns an IRQ# to the modem device.	Default
	3-11, NA		
Soft-Off by PWRBTN	Instant - Off	Select the Power Button Mode. Instant – Off : One push off. Delay 4 Sec : Push for 4s to switch off.	Default
	Delay 4 Sec		

3-4.2 PM Timers

PM Timers	Setting	Description	Note
<b>HDD Power Down</b>	Disable		Default
	1-15Min	When the set time has elapsed, BIOS sends a command to the HDD to power down. This turns off the HDD motor.	Some older model HDDs may not support this advanced function.
The following [Doze Mode] field may be configured only if [Power Management] is set to [User Define]			
<b>Doze Mode</b>	Disable		Default
	10sec-1Hour	When the set time has elapsed, BIOS sends a command to the system to enter Doze Mode.	System clock drops to 33MHz.
The following [Suspend Mode] field may be configured only if [Power Management] is set to [User Define]			
<b>Suspend Mode</b>	Disable		Default
	10sec-1Hour	In Suspend mode, the CPU stops completely (no instructions are executed.)	Only an SL-Enhanced (or SMI) CPU can enter this mode.

3-4.3 PM Events

PM Events	Setting	Description	Note
<b>VGA</b>	ON	Enabled the power managemnet.	
	OFF		Default
<b>LPT &amp; COM</b>	LPT/COM	Enabled the power management timer.	Default
	COM LPT NONE		
<b>HDD &amp; FDD</b>	ON	Enabled the power management timers when the event is detected on the Hard Disk Drive and Floppy Disk Drive device.	Default
	OFF		
<b>DMA/master</b>	ON	The system will not have SIM signal until the master is finished while the master is working.	
	OFF		Default
<b>Modem Ring Resume</b>	Disabled	Only work when the computer is powered on. The system will resume active when modem is ringing.	Default
	Enabled	The system will not resume when modem is ringing.	
<b>RTC Alarm Resume</b>	Disabled	The system ignores the alarm.	Default
	Enabled	Set alarm to wake up the system either by the date (1-31) or time (hh:mm:ss), and if the date is set to 0, it means that the system will wake up by the alarm everyday.	
<b>Primary INTR</b>	ON	Use the default setting.	Default
	OFF		

**PM Events (Continued)**

<b>PM Events</b>	<b>Setting</b>	<b>Description</b>	<b>Note</b>
<b>IRQ#</b>	Primary	IRQ3(COM2), IRQ4(COM1), IRQ5(LPT2), IRQ6(Floppy Disk), IRQ7(LPT1), IRQ12(PS/2 mouse), IRQ13(Coprocessor), IRQ14(HardDisk)	
	Secondary	IRQ9(IRQ2 Redir), IRQ10( Reserved), IRQ11(Reserved)	
	Disabled	IRQ8 (RTC Alarm), IRQ15 (Reserved)	

### 3-5 PNP/PCI CONFIGURATION SETUP

This option sets the Motherboard's PCI Slots.

ROM PCI/ISA BIOS	
PNP/PCI CONFIGURATION SETUP	
AWARD SOFTWARE, INC.	
PNP OS Installed	: No
Resources Controlled By	: Manual
ACPI I/O Device Node	: Disabled
IRQ-3 assigned to	: Legacy ISA
IRQ-4 assigned to	: Legacy ISA
IRQ-5 assigned to	: PCI/ISA PnP
IRQ-7 assigned to	: PCI/ISA PnP
IRQ-9 assigned to	: PCI/ISA PnP
IRQ-10 assigned to	: PCI/ISA PnP
IRQ-11 assigned to	: PCI/ISA PnP
IRQ-12 assigned to	: PCI/ISA PnP
IRQ-14 assigned to	: PCI/ISA PnP
IRQ-15 assigned to	: PCI/ISA PnP
DMA-0 assigned to	: PCI/ISA PnP
DMA-1 assigned to	: PCI/ISA PnP
DMA-3 assigned to	: PCI/ISA PnP
DMA-5 assigned to	: PCI/ISA PnP
DMA-6 assigned to	: PCI/ISA PnP
DMA-7 assigned to	: PCI/ISA PnP
CPU to PCI Write Buffer	: Enabled
PCI Master Broken Timer	: Disabled
PCI IRQ Activated By	: Level
Assign IRQ For USB	: Enabled
Assign IRQ For VGA	: Enabled
Assign IRQ For ACPI	: IRQ10
ESC : Quit                    ↑ ↓ → ← : Select Item F1 : Help                    PU/PD/+/- : Modify F5 : Old Values            (Shift) F2 : Color F6 : Load BIOS Defaults F7 : Load Setup Defaults	



**Note:** Starred (\*) items will disappear when the [Resources Controlled By] option is set to [Auto].

After you have completed the PCI Slot Configuration, press [Esc] and follow the instructions on your screen to save your settings or exit without saving.

3-5.1 PNP/PCI Configuration Controls

PNP/PCI Controls	Setting	Description	Note
<b>PNP OS Installed</b>	Yes	Use the default setting	Disabled
	NO		
<b>Resources Controlled By</b>	Manual	BIOS does not manage PCI/ISA PnP card IRQ assignment. Requires to assign IRQ-# and DMA-# to PCI or ISA PnP manually. IRQ-3,4,5,7,9,10,11,12,14,15 assigned to: _ DMA-0,1,3,5,6,7 assigned to: _	
	Auto	The Plug-and-Play BIOS auto manages PCI/ISA PnP card IRQ assignment automatically.	<b>Recommended</b>
<b>Reset Configuration Data</b>	Disabled	Retain PnP configuration data in BIOS.	Default
	Enabled	Reset PnP configuration data in BIOS.	
<b>ACPI I/O Device Node</b>	Disabled	Use the default setting	Default
	Enabled		



3-5.2 PNP/PCI Configuration Setup

PNP/PCI Setup	Setting	Description	Note
If [Resources Controlled By] is set to [Manual]			
<b>IRQ-# and DMA-# assigned to:</b>	PCI/ISA PnP	Choose IRQ-# and DMA-# assigned to PCI/ISA PnP card.	IRQ-3,4,5,7,9,10,11,12,14,15 DMA-0,1,3,5,6,7
	Legacy ISA	Choose IRQ-# and DMA-# assigned to Legacy ISA card.	IRQ-3,4,5,7,9,10,11,12,14,15 DMA-0,1,3,5,6,7
<b>CPU to PCI write Buffer</b>	Disabled		
	Enabled	Enable buffering of CPU writes to the PCI bus, the CPU will not have to wait.	Default
<b>PCI Master Broken Timer</b>	Disabled		Default
	Enabled	Enable to allow for slow PCI masters.	
<b>Assign IRQ For USB</b>	Disabled		
	Enabled	Enable RSB IRQ	Default
<b>Assign IRQ For VGA</b>	Disabled		
	Enabled	Enable if your VGA card needs an interrupt.	Default
<b>Assign IRQ For ACPI</b>	IRQ10	If you enable ACPI on your system, set this item to a free interrupt for ACPI to use.	Default
	IRQ11		
	IRQ9		

### 3-6 LOAD SETUP DEFAULTS

Select the [LOAD SETUP DEFAULTS] option from the Main Menu to load the system values you have previously saved. This option is recommended if you need to reset the system setup and to retrieve the old values.

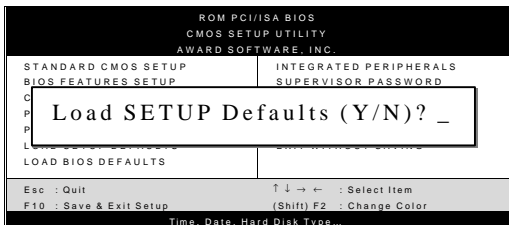

Type [Y] to use the Setup Defaults followed by [Enter] or otherwise [N] to return to the Main Menu and keep current values.

### 3-7 LOAD BIOS DEFAULTS

Select the [LOAD BIOS DEFAULTS] option from the Main Menu to load the system default values. BIOS Defaults values are adjusted to yield high performance.

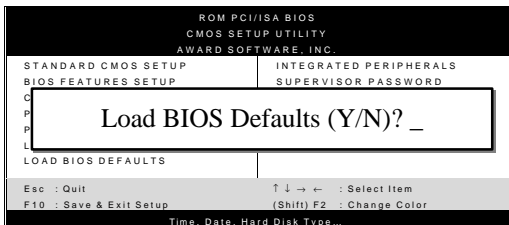

Type [Y] to use the Setup Defaults followed by [Enter] or otherwise [N] to return to the Main Menu and keep current values.



**Warning:** If you run into any problems after loading BIOS DEFAULTS, please load the SETUP DEFAULTS for stable performance.

### 3-8 INTEGRATED PERIPHERALS



**Caution:** Change these settings only if you are already familiar with the Chipset.

The [INTEGRATED PERIPHERALS] option changes the values of the chipset registers. These registers control the system options in the computer.

The following screen shows default settings.

ROM PCI/ISA BIOS			
INTEGRATED PERIPHERALS			
AWARD SOFTWARE, INC.			
OnChip IDE First Channel	: Enabled	Onboard Parallel Port	: 378
OnChip IDE Second Channel	: Enabled	Parallel Port Mode	: Normal
IDE Prefetch Mode	: Enabled	ECP Mode Use DMA	: 3
IDE HDD Block Mode	: Enabled	Parallel Port EPP Type	: EPP1.9
IDE Primary Master PIO	: Auto		
IDE Primary Slave PIO	: Auto		
IDE Secondary Master PIO	: Auto		
IDE Secondary Slave PIO	: Auto		
IDE Primary Master UDMA	: Auto		
IDE Primary Slave UDMA	: Auto		
IDE Secondary Master UDMA	: Auto		
IDE Secondary Slave UDMA	: Auto		
Init Display First	: PCI Slot	ESC : Quit	↑ ↓ → ← : Select Item
Onboard FDC Controller	: Enabled	F1 : Help	PU/PD/+/- : Modify
Onboard UART 1	: 3F8/IRQ4	F5 : Old Values	(Shift) F2 : Color
Onboard UART 2	: 2F8/IRQ3	F6 : Load BIOS Defaults	
Onboard UART 2 Mode	: Standard	F7 : Load Setup Defaults	

The following tables describe each field in the INTEGRATED PERIPHERALS Menu and provide instructions on how to configure the IDE controls, FDC controls, and the onboard serial and parallel ports.

### 3-8.1 IDE Device Controls

IDE Controls	Setting	Description	Note
<b>Onchip IDE Primary Channel</b>	Disabled	Use the On-board IDE Channel	Default
	Enabled		
<b>Onchip IDE Second Channel</b>	Disabled	Turn off the On-board IDE Channel	Default
	Enabled		
<b>IDE Prefetch Mode</b>	Disabled	Enable to enhance system performance.	Default
	Enabled		
<b>IDE HDD Block Mode</b>	Disabled	Invokes multi-sector transfer instead of one sector per transfer. Not all HDDs support this function.	Default
	Enabled		
<p>The following fields may be configured only if [Internal PCI/IDE] is set to [Both], [Primary], or [Secondary].</p>			
<b>IDE</b> > Primary Master PIO > Primary Slave PIO > Secondary Master PIO > Secondary Slave PIO	Mode 0-4	0 is the slowest speed 4 is the fastest speed	
	Auto	For better performance and stability, we suggest you use the Auto setting to set the HDD control timing.	Default
<b>IDE</b> > Primary Master UDMA > Primary Slave UDMA > Secondary Master UDMA > Secondary Slave UDMA	Disabled	Select Auto to enable Ultra DMA Mode support.	Default
	Auto		
<p>The following field may be configured only if [Internal PCI/IDE] is set to [Both], [Primary], or [Secondary].</p>			
<b>Init Display First</b>	PCI Slot	Select the VGA card that connects to the primary monitor.	Default
	AGP		

**3-8.2 FDC Controls**

FDC Controls	Setting	Description	Note
Onboard FDC controller	Disabled	Turn off the on-board floppy controller	
	Enabled	Use the on-board floppy controller	Default

**3-8.3 Onboard Serial Ports**

Onboard Serial Ports	Setting	Description	Note
Onboard UART 1 Onboard UART 2	Disabled		
	3F8/IRQ4	Choose serial port 1 & 2's I/O address.	Default (port 1)
	2F8/IRQ3	Do not set port 1 & 2 to the same address	Default (port 2)
	3E8/IRQ4 2E8/IRQ3	except for Disabled or Auto.	
	Auto		
Onboard UART 2 Mode	Standard	Supports a serial infrared IrDA.	Default
	HPSIR	Supports HP serial infrared interface format.	
	ASKIR	Supports a Sharp serial interface format.	

**3-8.4 Onboard Parallel Ports**

IR Pins Controls	Setting	Description	Note
IR Duplex mode	Half	Select the IR mode your IR module supports	Default
	Full		
Use IR Pins	IR-RX2TX2		Default
	IR-RX TX		

**3-8.5 Onboard Parallel Ports**

Onboard Parallel Ports	Setting	Description	Note
Onboard Parallel Port	378	Choose the printer I/O address.	Default
	Disabled		
	3BC		
	278		
Parallel Port Mode	ECP + EPP	The mode depends on your external device that connects to this port.	Default
	Normal		
	EPP		
	ECP		
If [Parallel Port Mode] is set to [ECP] or [ECP+EPP].			
ECP Mode Use DMA	3	Choose DMA3	Default
	1	Choose DMA1	
If [Parallel Port Mode] is set to [EPP] or [ECP+EPP].			
Parallel Port EPP Type (EPP Version)	EPP1.9	Choose EPP Ver. 1.9	Default
	EPP1.7	Choose EPP Ver. 1.7	

### 3-9 SUPERVISOR PASSWORD

Based on the setting you have made in the [Security Option] of the [BIOS FEATURES SETUP] section, the password prevents access to the system or the setup program by unauthorized users. Follow this procedure to set a new password or disable the password:

1. Choose [BIOS FEATURES SETUP] in the Main Menu and press [Enter]. Select the [Security Options] item and set the field to:
  - a. [System]: The password is required every time the system is booted. This means only a person who knows the password can use this computer.
  - b. [Setup]: The password is required only when you attempt to enter the BIOS Setup program.
2. Choose [SUPERVISOR PASSWORD] from the Main Menu and press [Enter]. The following prompt appear:

Enter Password:



---

**Warning:** If you forget or lose the password, the only way to access the system is to set jumper JP5 to clear the CMOS RAM. All setup information is lost and you must run the BIOS setup program again.

---



---

**Note:** If you do not wish to use the password function, press [Enter] directly and the following message appears:

Password Disabled!!

---

- 3. Enter your new password and press [Enter]. The following message appears, prompting to confirm the new password:

Confirm Password:

- 4. Re-enter your password and then press [Enter] to exit to the Main Menu.

This diagram outlines the password selection procedure:

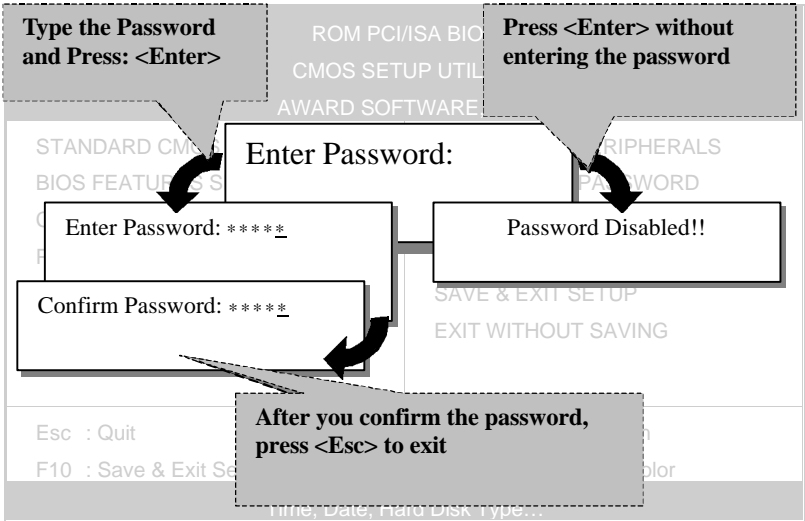

### 3-10 USER PASSWORD

When the user password option is on, you are not allowed to change any setting in the [CMOS SETUP UTILITY] except for changing the user's password.

The password setting procedure is similar to that for the [SUPERVISOR PASSWORD] (Refer to section 3-9).



### 3-11 IDE HDD AUTO DETECTION

This Main Menu function automatically detects the hard disk type and configures the STANDARD CMOS SETUP accordingly.

ROM PCI/ISA BIOS CMOS SETUP UTILITY AWARD SOFTWARE, INC.								
HARD DISKS	TYPE	SIZE	CYLS	HEAD	PRECOMP	LANDZ	SECTOR	MODE
Primary Master	: AUTO	0	0	0	0	0	0	AUTO
Primary Slave	: None	0	0	0	0	0	0	----
Secondary Master	: None	0	0	0	0	0	0	----
Secondary Slave	: None	0	0	0	0	0	0	----

Do you accept this drive C (Y/N)? \_

ESC : Skip



**Note:** This function is only valid for IDE type of hard disk drives.

## Chapter 4

### DRIVERS INSTALLATION

Your SY-5EMA+ Super 7™ Motherboard comes with a CD-ROM labeled "SOYO CD." The SOYO CD contains the user's manual file for your new Motherboard, the drivers software available for installation, and a database in HTML format with information on SOYO Motherboards and other products.

**Step 1.** Insert the SOYO CD into the CD-ROM drive. The SOYO CD will auto-run, and the SOYO CD Start Up Menu will display as shown below.

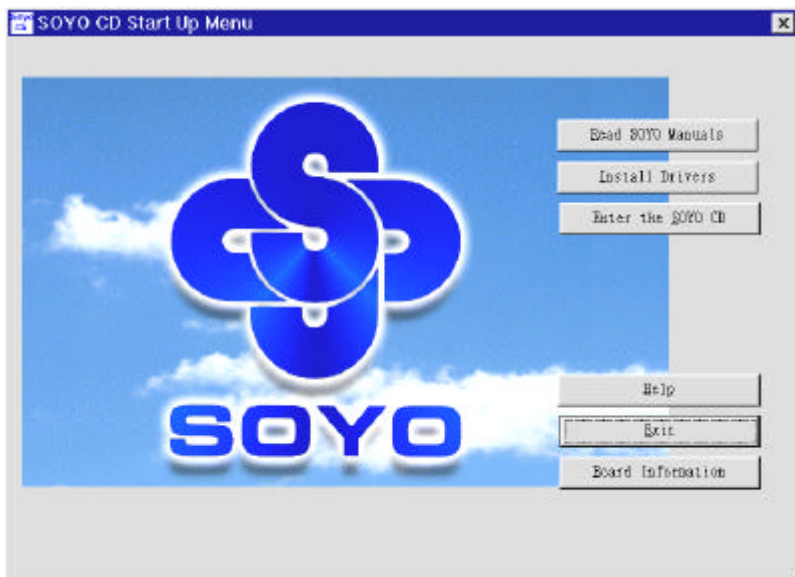

#### (SOYO CD Start Up Program Menu)

The SOYO CD Start Up Program automatically detects which SOYO Motherboard you own and displays the corresponding model name.

**Step 2.** Installation procedure for Windows 95/98

The following describes the best way of installing Windows 95 or Windows 98 on your 5EMA+ Motherboard:

- The following BIOS default settings should not be changed:
  1. The 'USB Controller' item under 'Chipset features' is set to enabled.
  2. The 'USB Assigned IRQ' item under 'PnP/PCI Configuration' is set to enabled.

You **MUST** have these two items enabled for Windows 95/98 to run properly on your system.

- Install Windows 95/98
- After installation of windows, you will need to install the ETEQ drivers. Follow the instruction below.

Click the **Install Drivers** button to display the list of drivers that can be installed on your Motherboard. The start-up program displays the drivers available for the 5EMA+ and the Windows version you use. For Windows 95 four drivers will be listed (see 'Driver Installation Menu' below), for Windows 98 three drivers will be listed (the ACPI drivers will be left out). We recommend you to install all drivers, and to do so in the right sequence (top to bottom).

If you want to see all the drivers available on the SOYO -CD, click the **Display all drivers on the SOYO CD** button. Do NOT install drivers that are not suitable for you board, otherwise your system may crash.

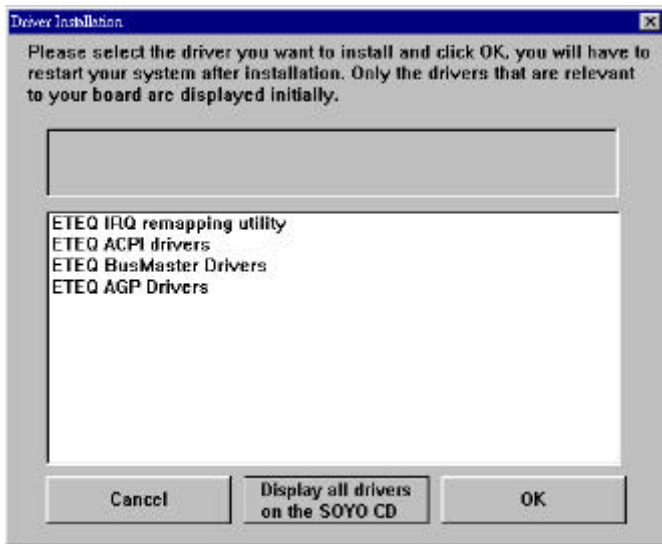

(Driver Installation Menu)

Select which driver you want to install and click **OK**, or click **Cancel** to return to the main menu. When the installation program of a driver starts running the SOYO-CD will exit. After finishing the installation, restart the SOYO-CD and install the next driver.

**Note:** Once you have selected a driver, the system will automatically exit the SOYO CD to begin the driver installation program. When the installation is complete, most drivers require to restart your system before they can become active.