



# EP-6VBE

**A Pentium® II or Pentium® III  
Slot1 Processor based AGP  
mainboard (100/66MHz)**

## TRADEMARK

All products and company names are trademarks or registered trademarks of their respective holders.

*These specifications are subject to change without notice.*

*Manual Revision 1.0  
November 03, 1999*

## User Notice

No part of this product, including the product and software may be reproduced, transmitted, transcribed, stored in a retrieval system, or translated into any language in any form without the express written permission of EPoX Computer Company (hereinafter referred to as EPoX) except for documentation kept by the purchaser for backup purposes.

We provide this manual “as is” without warranty of any kind, either expressed or implied, including but not limited to the implied warranties or conditions of merchantability or fitness for a particular purpose. In no event shall EPoX be liable for any loss of profits, loss of business, loss of use or data, interruption of business or for indirect, special incidental, or consequential damages of any kind, even if EPoX has been advised of the possibility of such damages arising from any defect or error in the manual or product. EPoX may revise this manual from time to time without notice. For updated BIOS, drivers, or product release information you may visit our websites at <http://www.epox.com> or <http://www.epox.com.tw>.

Products mentioned in this manual are mentioned for identification purposes only. Product names appearing in this manual may or may not be registered trademarks or copyrights of their respective companies. **The product name and revision number are both printed on the mainboard itself.**

## Handling Procedures

Static electricity can severely damage your equipment. Handle the EP-6VBE and any other device in your system with extreme care and avoid unnecessary contact with system components on the mainboard. Always work on an antistatic surface to avoid possible damage to the mainboard from static discharge. Always have the power supply unplugged and powered off when inserting and removing devices within the computer chassis. EPoX assumes no responsibility for any damage to the EP-6VBE mainboard that results from failure to follow instruction or failure to observe safety precautions.



### **CAUTION**



**The EP-6VBE mainboard is subject to damage by static electricity. Always observe the handling procedures.**

---

### **Technical Support Services**

If you need additional information, help during installation or normal use of this product, please contact your retailer. Your retailer will have the most current information about your configuration. If your retailer cannot help, you may visit our online technical support website and/or contact our support technicians at the locations listed below.

Record your serial number before installing your EP-6VBE mainboard. (The serial number is located near the ISA slots at the edge of the board.)

**EP-6VBE serial number:** \_\_\_\_\_

### **Contacting Technical Support**

EPoX technical support is working hard to answer all of your questions online. From our website you can find answers to many common questions, drivers, BIOS updates, tech notes, and important technical bulletins. If you are still unable to locate the solution you are seeking, you always have the option to contact our support technicians directly.

#### **North American website (English language)**

<http://www.epox.com>

[sales@epox.com](mailto:sales@epox.com)

[support@epox.com](mailto:support@epox.com)

#### **European website (Multi-language)**

<http://www.epox.nl>

[sales@epox.nl](mailto:sales@epox.nl)

[support@epox.nl](mailto:support@epox.nl)

#### **Taiwan website (Chinese language)**

<http://www.epox.com.tw>

[sales@epox.com.tw](mailto:sales@epox.com.tw)

[support@epox.com.tw](mailto:support@epox.com.tw)

*Thank you for using EPoX mainboards!*

*Copyright 1999 EPoX Computer Company. All rights reserved.*

---

---

**Table of Contents**

---

		<i>Page</i>
<b>Section 1</b>	<b><i>Introduction</i></b>	
	Components Checklist .....	1-1
	<b><i>Overview</i></b>	
	Pentium® II or Pentium® III Processor .....	1-2
	S.E.C. Cartridge Terminology .....	1-3
	Accelerated Graphics Port .....	1-4
	Hardware Monitoring .....	1-4
	Power-On/Off (Remote) .....	1-5
	System Block Diagram .....	1-6
<b>Section 2</b>	<b><i>Features</i></b>	
	EP-6VBE Features .....	2-1
<b>Section 3</b>	<b><i>Installation</i></b>	
	EP-6VBE Detailed Layout .....	3-2
	<b><i>Easy Installation Procedure</i></b>	
	Configure Jumpers .....	3-3
	System Memory Configuration .....	3-5
	Installing a Pentium® II/III Processor .....	3-7
	Device Connectors .....	3-9
	External Modem Ring-in Power ON and Keyboard Power ON Function (KBPO) .....	3-11
<b>Section 4</b>	<b><i>Award BIOS Setup</i></b>	
	BIOS Instructions .....	4-1
	Standard CMOS Setup .....	4-2
	BIOS Features Setup .....	4-3
	Chipset Features Setup .....	4-8
	Power Management Setup .....	4-11
	PNP/PCI Configuration .....	4-14
	Load Setup Defaults .....	4-16

---

Integrated Peripherals .....	4-17
Change Supervisor or User Password .....	4-22
IDE HDD Auto Detection .....	4-23
Save & Exit Setup .....	4-25
Exit Without Saving .....	4-25

***Section 6***

***Appendix***

***Appendix A***

Memory Map .....	A-1
I/O Map .....	A-1
Timer & DMA Channels Map .....	A-2
Interrupt Map .....	A-2
RTC & CMOS RAM Map .....	A-3

***Appendix B***

POST Codes .....	A-5
Unexpected Errors .....	A-8

***Appendix C***

Load Setup Defaults .....	A-9
---------------------------	-----

***Appendix D***

GHOST 5.1 Quick User's Guide .....	A-11
------------------------------------	------

---



**Section 1**  
**INTRODUCTION**

**Components Checklist**

- ✓ A. (1) EP-6VBE mainboard
- ✓ B. (1) EP-6VBE user's manual
- ✓ C. (1) Floppy ribbon cable
- ✓ D. (1) ATA66 IDE ribbon cable
- ✓ E. (1) Foldable Retention Module
- ✓ F. (1) PS/2 Mouse Connector
- ✓ G. (1) COM Port/LPT Port Connector
- ✓ H. (1) Bus master drivers

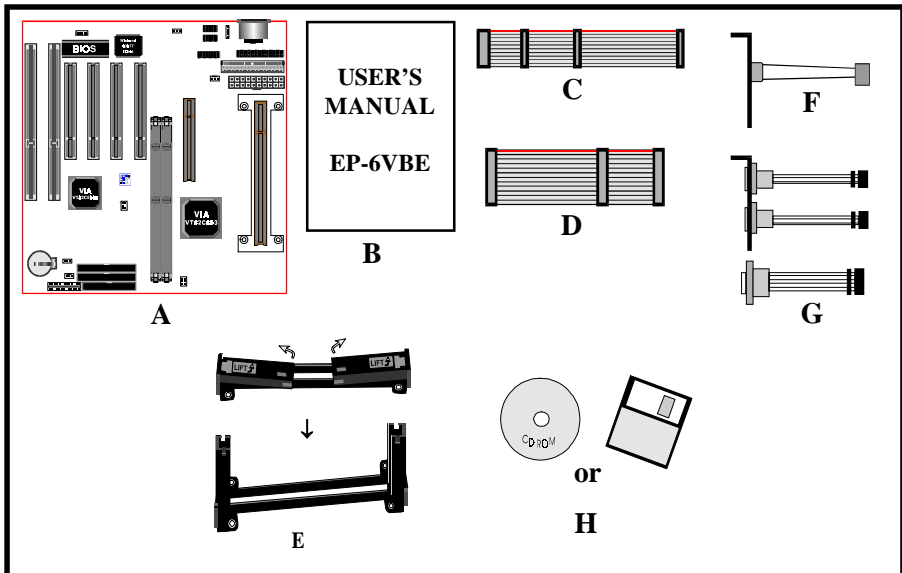

## **Pentium® II or Pentium® III Processor**

The Pentium® II or Pentium® III Processor (The Pentium® III Processor as 400/100MHz and 450/100MHz speed or above with 512K-L2 cache Versions.) is the follow-on to the Pentium® Processor. The Pentium® II or Pentium® III Processor, like the Pentium® Pro processor, implements a Dynamic Execution micro-architecture -- a unique combination of multiple branch prediction, data flow analysis, and speculative execution. This enables the Pentium® II/III Processor to deliver higher performance than the Pentium® processor, while maintaining binary compatibility with all previous Intel architecture processors.

A significant feature of the Pentium® II or Pentium® III Processor, from a system perspective, is the built-in direct multiprocessing support. In order to achieve multiprocessing, and maintain the memory and I/O bandwidth to support it, new system designs are needed. For systems with dual processors, it is important to consider the additional power burdens and signal integrity issues of supporting multiple loads on a high speed bus. The Pentium® II or Pentium® III Processor card supports both uni-processor and dual processor implementations.

The Pentium® II or Pentium® III Processor utilizes Single Edge Contact (S.E.C.) (Figure 1) cartridge packaging technology. The S.E.C. cartridge allows the L2 cache to remain tightly coupled to the processor, while maintaining flexibility when implementing high performance processors into OEM systems. The second level cache is performance optimized and tested at the cartridge level. The S.E.C. cartridge utilizes surface mounted core components and a printed circuit board with an edge finger connection. The S.E.C. cartridge package introduced on the Pentium® II Processor will also be used in future Slot 1 processors.

The S.E.C. cartridge has the following features: a thermal plate, a cover and a PCB with an edge finger connection. The thermal plate allows standardized heatsink attachment or customized thermal solutions. The thermal plate enables a reusable heatsink to minimize fit issues for serviceability, upgradeability and replacement. The full enclosure also protects the surface mount components. The edge finger connection maintains socketability for system configuration. The edge finger connector is denoted as 'Slot 1 connector' in this and other documentation.



The entire enclosed product is called the Pentium® II or Pentium® III Processor. The packaging technology and each of the physical elements of the product are referred to using accurate technical descriptions. This allows clear reference to the products as just a processor. This is the model used in past packaging technologies like PGA, TCP, PQFP, DIP, etc.

## **S.E.C. Cartridge Terminology**

- Pentium® II or Pentium® III Processor  
The new enclosed card packaging technology is called a “Single Edge Contact cartridge.” This is similar to previous names for packaging technology such as PGA or TCP.
- Processor card  
The green PCB (with or without components on it)
- Processor core  
The silicon on the PLGA package on the PCB
- Cover  
The plastic cover on the opposite side from the thermal plate.
- Slot 1  
The slot that the S.E.C. cartridge plugs into, just as the Pentium® Pro processor uses Socket 8.
- Retention mechanism  
Formerly ‘retention module’ the dual posts, etc. that holds the cartridge in place.
- Thermal plate  
The heatsink attachment plate.
- Heat sink supports  
The support pieces that are mounted on the mainboard to provide added support for heatsinks.

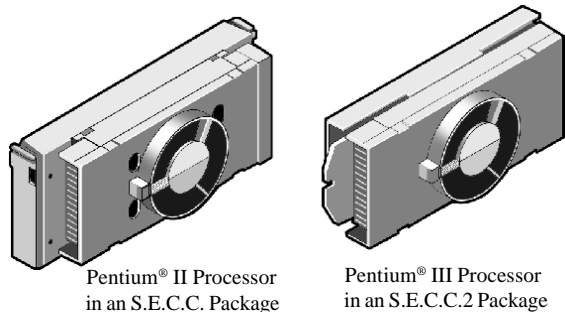

*Figure 1: Pentium® II/III Processor CPU  
with S.E.C.C. or S.E.C.C.2 Package*

The L2 cache (TagRAM, PBSRAM) components keep standard industry names.

The Pentium® II or Pentium® III Processor is the first product to utilize the S.E.C. cartridge technology and Slot 1 connector. Unless otherwise noted, any references to “Pentium® II Processor,” “Pentium® II or Pentium® III Processor/Slot 1 processor” or “Pentium III Processor” will apply to both the Pentium® II Processor desktop processors.

## **Accelerated Graphics Port (AGP or A.G.P.)**

---

Typically, 3D graphics rendering requires a tremendous amount of memory, and demands ever increasing throughput speed as well. As 3D products for the personal computer become more and more popular, these demands will only increase. This will cause a rise in costs for both end users and manufacturers. Lowering these costs as well as improving performance is the primary motivation behind AGP. By providing a massive increase in the bandwidth available between the video card and the processor, it will assist in relieving some of these pressures for quite sometime.

## **Hardware Monitoring**

---

Hardware monitoring allows you to monitor various aspects of your systems operations and status. The features include CPU temperature, voltage and RPM of fan.

## Power-On/Off (Remote)

The **EP-6VBE** has a single 20-pin connector for MicroATX power supplies. For MicroATX/ATX power supplies that support the **Remote On/Off** feature, this should be connected to the systems front panel for system Power On/Off button. The systems power On/Off button should be a momentary button that is normally open.

The **EP-6VBE** has been designed with "Soft Off" functions. You can turn Off the system from one of two sources: The first is the front panel Power On/Off the button, and the other is the "Soft Off" function (coming from the EP-6VBE's onboard circuit controller) that can be controlled by the operating system. Windows 95/98 will control this when the user clicks that they are ready to Shutdown the system.

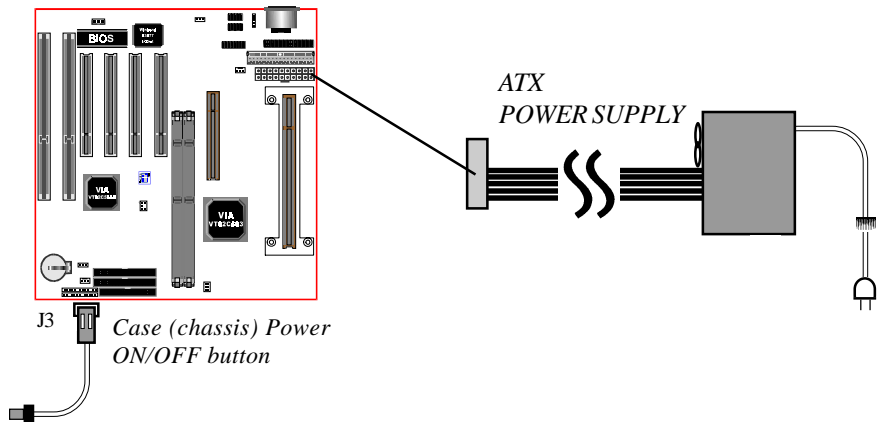

*Figure 2: Simple ATX Power  
ON/OFF Controller*

**System Block Diagram**

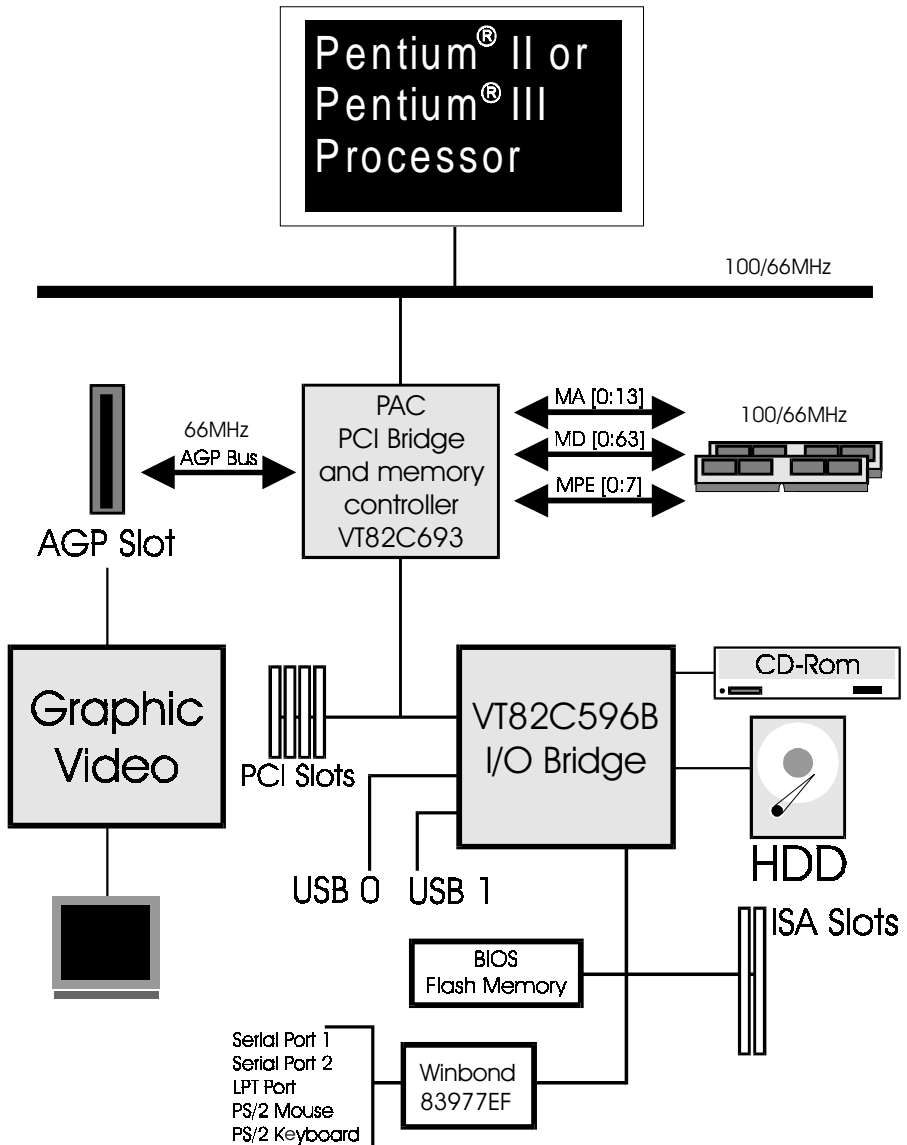

Figure 3: System Block Diagram

---

## Section 2 FEATURES

---

### EP-6VBE Features:

- EP-6VBE is based on the Pentium® II or Pentium® III Processor operating at 233 ~ 400MHz (66MHz) or 300 ~ 550MHz (100MHz) on Slot 1. The board is configured by a DIP Switch to match your CPU clock speed.
- Designed with VIA Apollo Pro PCIset.
- Supports up to 256 MB of DRAM (minimum of 8 MB) on board, You can use 168-pin DIMM x 2. It will automatically detect Extended Data Output (EDO) DRAM at 66MHz only or Synchronous DRAM memory (SDRAM) at 66MHz or 100MHz (please see Section 3-2).
- Supports (2) 16 bit ISA slots, (4) 32 bit PCI slots, (1) AGP slot and provides (2) independent high performance PCI IDE interfaces capable of supporting PIO Mode 3/4 and Ultra DMA 33/66 devices. The EP-6VBE supports (4) PCI Bus Master slots and a jumperless PCI INT# control scheme which reduces configuration confusion when plugging in PCI card(s).
- Supports ATAPI (e.g. CD-ROM) devices on both Primary and Secondary IDE interfaces.
- Designed with Winbond W83977EF Multi I/O: (1) floppy port, (1) parallel port (EPP, ECP), and (2) serial ports (16550 Fast UART).  
Note: Japanese “Floppy 3 mode” is also supported
- Includes a PS/2 mouse connector.
- Features Award Plug & Play BIOS. With Flash Memory you can always upgrade to the current BIOS as they are released. (<http://www.epox.com> please visit our Technical Support section for the latest updates).
- EP-6VBE utilizes a Lithium battery which provides environmental protection and longer battery life.

- Supports the Universal Serial Bus (USB) connector. The onboard VT82C596B chip provides the means for connecting PC peripherals such as; keyboards, joysticks, telephones, and modems.
- Built-in ATX 20-pin and AT 12-pin power supply connector.
- Software power-down when using Windows® 95/98.
- Supports ring-in feature (remote power-on through external modem, allow system to be turned on remotely).
- Resume by Alarm - Allow your system to turn on at a preselected time.
- Supports CPU Hardware sleep and SMM (System Management Mode).
- Supports Keyboard Power ON function (KBPO).
- Built-in WOL (Wake On Lan) Connector.
- Built-in SB-LINK Connector.
- Power Loss Recovery - In the event of a power outage your system will automatically turn itself back on without user intervention.

# Section 3 INSTALLATION

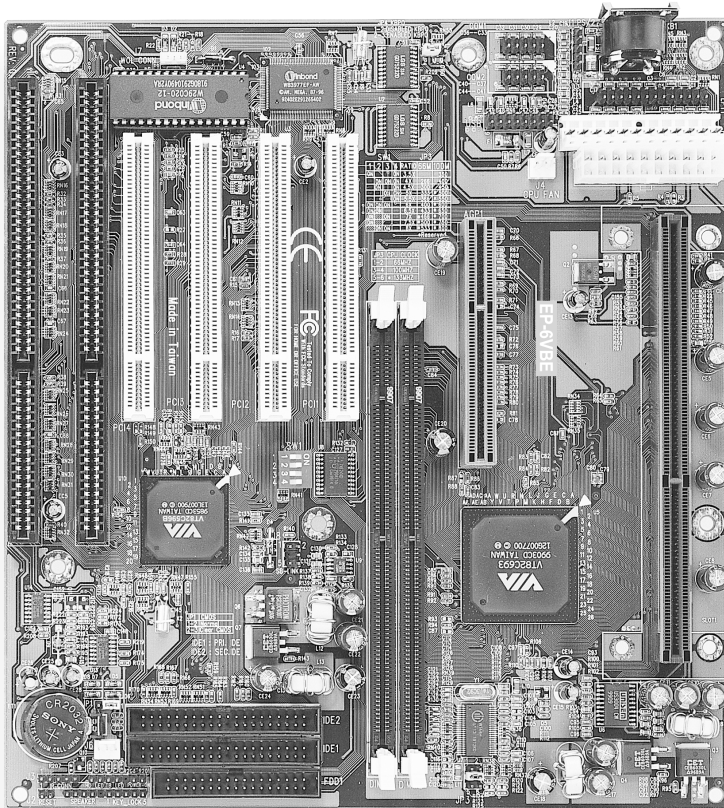

**EP-6VBE Detailed Layout**

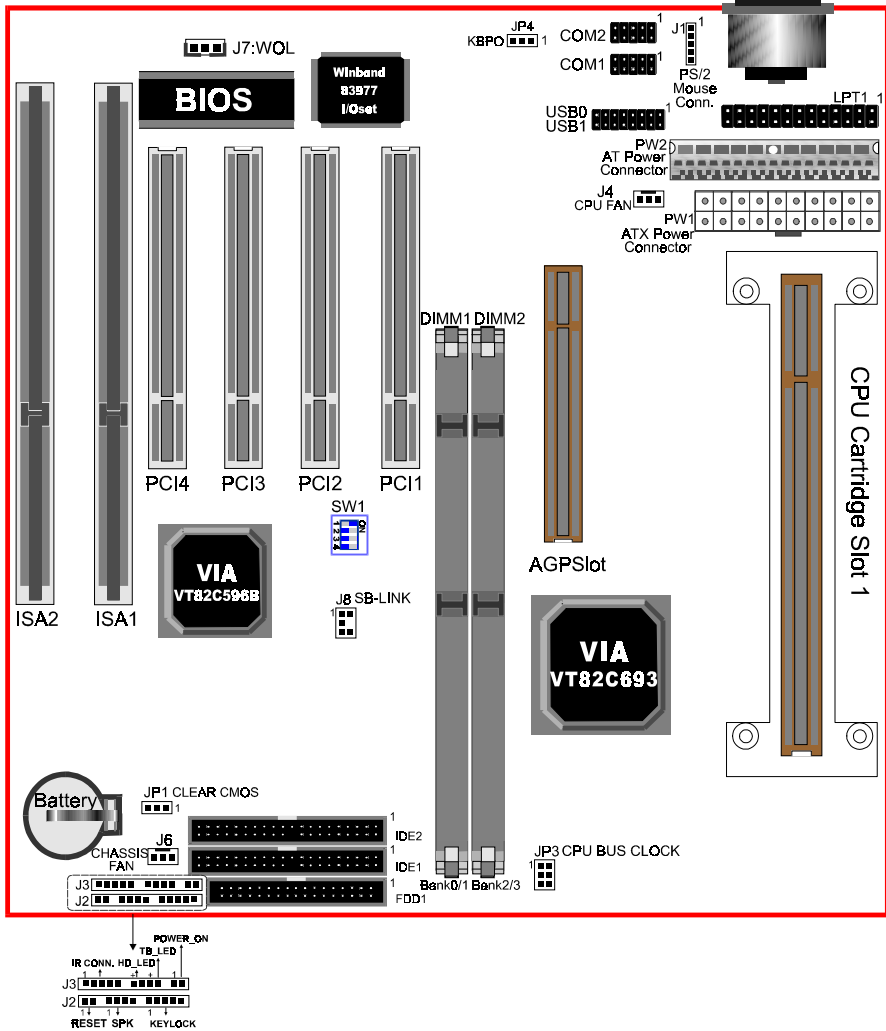

Figure 1



## Easy Installation Procedure

### Easy Installation Procedure

The following must be completed before powering on your new system:

- 3-1. **Configure Jumpers**
- 3-2. **System memory Configuration**
- 3-3. **Install Pentium® II/III Processor**
- 3-4. **Device Connectors**
- 3-5. **External Modem Ring-in Power On and Keyboard Power On Function (KBPO)**

### Section 3-1 Configure Jumpers

We designs all motherboards with the fewest jumpers to make your installation fast and easy.

The following will describe all of the jumpers that you are required to set before moving on to step 3-2.

*Note: The jumpers as depicted as shown (Figure 1) in their correct physical orientation.*

**JP1** CMOS Clear



JP1 = 1-2 - Normal (Default)  
= 2-3 - Clear CMOS (momentarily)

**JP4** Keyboard Power On Function



JP4 = 1-2 - Disabled (Default)  
= 2-3 - Enabled

**J7**



**WOL (Wake On Lan) Connector**  
Reserved for NIC (Network Interface Card) to Wake the System.

**J8**



**SB-LINK Connector**  
Reserved for Creative SB-LINK™ (Sound Blaster LINK™) with the Sound Blaster AWE64D PCI Sound Card to Compatible DOS games and Multimedia applications.

**JP3: CPU Bus Clock Selection**



JP3	CPU CLOCK
1-2	66MHz
3-4	100MHz
5-6	*133MHz

**SW1: CPU Speed Selection**



SW1					CPU (MHz)	
1	2	3	4	RATIO	66MHz	100MHz
ON			ON	3.5X		350
	ON	ON	ON	4X	266	400
	ON		ON	4.5X	300	450
		ON	ON	5X	333	*500
			ON	5.5X	366	*550
ON	ON	ON		6X	400	*600
ON	ON			6.5X	433	*650
ON		ON		7X	*466	*700
ON				7.5X	*500	*750
	ON	ON		8X	*533	*800

\* Reserved

## Section 3-2 System Memory Configuration

### Memory Layout

The EP-6VBE supports (2) 168-pin DIMMs (Dual In-line Memory Module). The DIMMs can be either EDO (Extended Data Out) or SDRAM (Synchronized DRAM).

- **We recommend not mixing SDRAM DIMM and EDO DIMM together.**
- EDO DIMM can only be used with the 66MHz FSB.
- We recommend using at least 125MHz (-8ns) SDRAM DIMM at the 100MHz (or higher) FSB as timing becomes more critical at these higher speeds.
- DIMM SDRAM may be 83MHz (-12ns), 100MHz (-10ns) or 125MHz (-8ns) bus speed.

Figure 2 and Table 1 show several possible memory configurations using

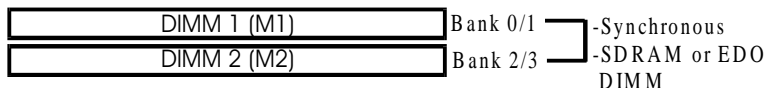

Figure 2

Total Memory	DIMM 1 (Bank 0/1)	DIMM 2 (Bank 2/3)
= 256MB Maximum	EDO/SDRAM* 8MB, 16MB, 32MB, 64MB, 128MB x 1	EDO/SDRAM* 8MB, 16MB, 32MB, 64MB, 128MB x 1
= 128MB Maximum	EDO/SDRAM* 8MB, 16MB, 32MB, 64MB, 128MB x 1	None

Table 1

- \* SDRAM only supports 8, 16, 32, 64, 128MB DIMM modules.
- \* EDO DIMM can only be used with the 66MHz FSB.

## DIMM Module Installation

Figure 3 displays the notch marks and what they should look like on your DIMM memory module.

DIMMs have 168-pins and two notches that will match with the onboard DIMM socket. DIMM modules are installed by placing the chip firmly into the socket at a 90 degree angle and pressing straight down (figure 4) until it fits tightly into the DIMM socket (figure 5).

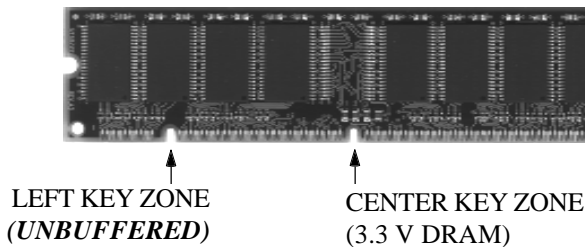

Figure 3

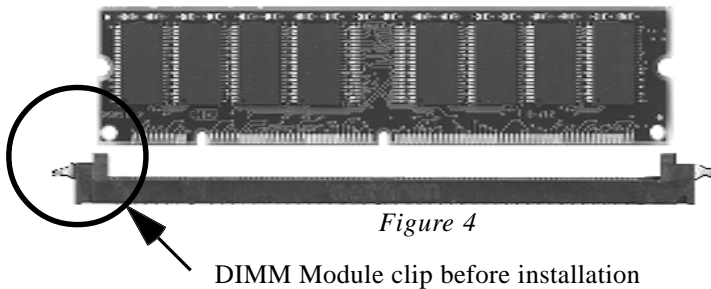

Figure 4

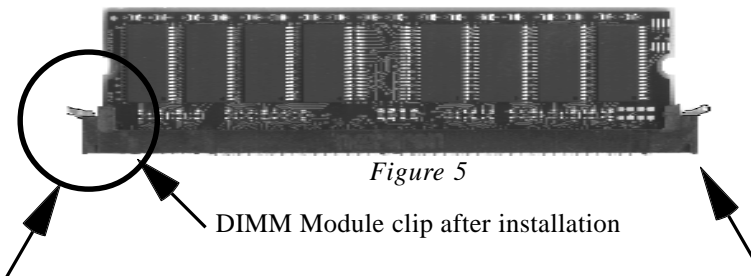

Figure 5

To remove the DIMM module simply press down both of the white clips on either side and the module will be released from the socket.

### Section 3-3

## Installing a Pentium® II/III Processor

---

The EP-6VBE uses the Single Edge Contact (SEC) slot for a Pentium® II/III processor packaged in an SEC cartridge. The SEC slot is not compatible with other non-Pentium® II/III processors.

Please have ready the following list of components so that we may install the processor onto the motherboard.

1. Pentium® II/III processor heat sink
2. Intel Pentium® II/III Processor

OK, now that you have all of your components ready, we can start.

- 1 First, please refer to figure 18 below, and follow the direction to lift up the fixed foldable pentium® II/III Retention Mechanism. This pre-installed device is designed for you to install Pentium® II/III CPU more easier and to avoide any damage on the board due to overtightening the four screws.
- 2 One thing must be kept in your mind that please make sure to lift upright the foldable parts of the Retention module to fit and install CPU properly.

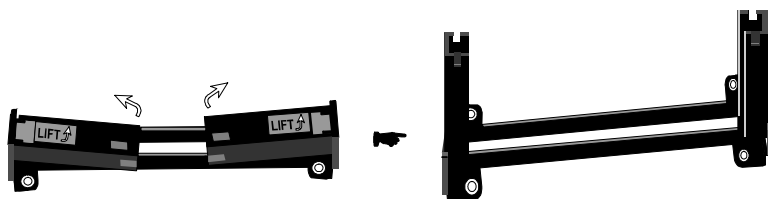

Figure 6

Now we are going to put the heatsink or cooler onto Pentium® II/III processor. Due to the processor faster and more powerful features. The power consumption is larger than past processor. We strongly recommend a good attached fan/ heatsink or cooler onto the processor's OLGA package.

The Pentium® II/III processor may also be offered as Intel® boxed processors. The boxed processor's fan heatsink requires a +12V power supply. A fan power

cable will be shipped with the boxed processor to draw power from a power header on the mainboard's J4.

Now we are ready to install the SEC Cartridge (Pentium II/III Processor) into the Retention Module. The SEC Cartridge is mounted by sliding the SEC Cartridge into the Retention Module and letting it slide all the way down. Once it reaches the bottom make sure you press firmly on SEC cartridge to firmly secure into the Slot 1 Socket.

## **Section 3-4**

### **Device Connectors**

---

Please install the motherboard into the chassis.

**J1:** PS/2 Mouse Connector

**J2,J3:** Chassis Panel Connector

- Keylock, Speaker, Reset, Sleep, Turbo LED and HDD LED

**J4:** CPU Fan Power

- A plug-in for the CPU Fan Power

**J6:** Chassis Fan Power

- A plug-in for the chassis Fan Power

**J7:** WOL (Wake On Lan) Connector

**J8:** SB-LINK Connector

**PW1:** ATX Power Connector

- 20-pin power connector

**PW2:** ATX Power Connector

- 12-pin power connector

**IDE1:** Primary IDE Connector

**IDE2:** Secondary IDE Connector

**FDD1:** Floppy Controller Connector

**LPT1:** Printer Port Connector

**COM1, COM2:** Serial Ports Connector

**Device Connectors (continued)**

(This is connected to the power button on the case. Using the Soft-Off by Pwr-BTTN feature, you can choose either Instant Off (turns system off immediatly), or 4 sec delay (you need to hold the button down for 4 seconds before the system turns off). When the system is in 4 sec delay mode, there is a special feature to make the system to go into suspend mode when the button is pressed momentarily.)

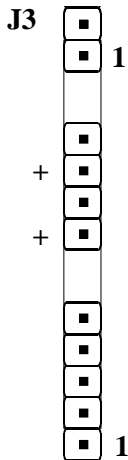

**Power On/Off**

**Turbo LED indicator** - LED ON when higher speed is selected

**IDE LED indicator** - LED ON when Onboard PCI IDE Hard disks is activate

**IR Connector**

- |         |         |
|---------|---------|
| 1. VCC  | 4. GND  |
| 2. NC   | 5. IRTX |
| 3. IRRX |         |

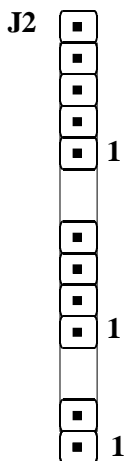

**KeyLock** - Keyboard lock switch & Power LED connector

- |                 |            |
|-----------------|------------|
| 1. Power LED(+) | 4. Keylock |
| 2. N/C          | 5. GND     |
| 3. GND          |            |

**Speaker** - Connect to the system's speaker for beeping

- |            |        |
|------------|--------|
| 1. Speaker | 3. GND |
| 2. N/C     | 4. GND |

**Reset** - Closed to restart system.



## Section 3-5

### External Modem Ring-in Power ON and Keyboard Power ON Functions (KBPO)

---

On the basis of bounded functions in I/O chipset, the two serial ports are able to support the External Modem Ring-in Power ON function. Once users connect the external modem to COM1 or COM2, the allows users to turn on their system through the remote and host's dial-up control.

#### Exclusive Keyboard Power ON Function

To innovate a unique feature to benefit users, we devoted the easiest and most convenient way to turn on your system based on the the ATX power supply.

How to work with it

**Step 1:** Please check JP4 at the position 2-3 after you finished the system installation.

JP4



Keyboard Power-ON Function

1-2: Disabled (Default)

2-3: Enabled

**Step 2:** You can enjoy the Keyboard Power ON function (KBPO) by *pressing any 2 key and BUTTON only to turn on your system*. Your system will be turned on automatically, after releasing the keys. To power off you system, you can use the Soft-OFF function under Windows 95.

**Notes:** Intel ATX version 2.0 specification has recommended you use the power supply with 0.72A(720mA) in 5.0VSB. With our this mainboard, *the 5.0VSB standby power only has to be  $\geq 0.2A$  (200mA)* then you can enjoy this unique benefit. However, the ATX power supply which is  $< 0.2$  (200mA) is still applicable to your system by placed JP4 at the position 1-2 to disable this feature.

**Page Left Blank**

---

## Section 4

# AWARD BIOS SETUP

### BIOS Instructions

Award's ROM BIOS provides a built-in Setup program which allows user to modify the basic system configuration and hardware parameters. The modified data will be stored in a battery-backed CMOS, so that data will be retained even when the power is turned off. In general, the information saved in the CMOS RAM will stay unchanged unless there is a configuration change in the system, such as hard drive replacement or a device is added.

It is possible for the CMOS battery to fail, this will cause data loss in the CMOS only. If this does happen you will need to reconfigure your BIOS settings.

#### To enter the Setup Program :

Power on the computer and press the <Del> key immediately, this will bring you into the BIOS CMOS SETUP UTILITY.

ROM PCI / ISA BIOS (2A6LFPAB)  
CMOS SETUP UTILITY  
AWARD SOFTWARE, INC.

STANDARD CMOS SETUP BIOS FEATURES SETUP CHIPSET FEATURES SETUP POWER MANAGEMENT SETUP PNP/PCI CONFIGURATION INTEGRATED PERIPHERALS LOAD SETUP DEFAULTS	SUPERVISOR PASSWORD USER PASSWORD IDE HDD AUTO DETECTION SAVE & EXIT SETUP EXIT WITHOUT SAVING
ESC : Quit F10 : Save & Exit Setup	
↑ ↓ → ← : Select Item (Shift)F2 : Change Color	
Time, Date, Hard Disk Type...	

*Figure 1: CMOS Setup Utility*

The menu displays all the major selection items. Select the item you need to reconfigure. The selection is made by moving the cursor (press any direction key ) to the item and pressing the ‘Enter’ key. An on-line help message is displayed at the bottom of the screen as the cursor is moved to various items which provides a better understanding of each function. When a selection is made, the menu of the selected item will appear so that the user can modify associated configuration parameters.

### **4-1 Standard CMOS Setup**

Choose “Standard CMOS Setup” in the CMOS SETUP UTILITY Menu (Figure 2). The Standard CMOS Setup allows the user to configure system settings such as the current date and time, type of hard disk drive installed, floppy drive type, and display type. Memory size is auto-detected by the BIOS and displayed for your reference. When a field is highlighted (use direction keys to move the cursor and the <Enter> key to select), the entries in the field can be changed by pressing the <PgDn> or the <PgUp> key.

ROMPCI/ISA BIOS(2A6LFPAB)  
STANDARD CMOS SETUP  
AWARD SOFTWARE, INC.

Date (mm:dd:yy) : Wed, Apr 17 1996																						
Time (hh:mm:ss) : 14 : 30 : 50																						
<u>HARD DISKS</u>	<u>TYPE</u>	<u>SIZE</u>	<u>CYLS</u>	<u>HEAD</u>	<u>PRECOMP</u>	<u>LANDZONE</u>	<u>SECTORS</u>	<u>MODE</u>														
Primary Master	: <b>Auto</b>	0	0	0	0	0	0	<b>Auto</b>														
Primary Slave	: <b>Auto</b>	0	0	0	0	0	0	<b>Auto</b>														
Secondary Master	: <b>Auto</b>	0	0	0	0	0	0	<b>Auto</b>														
Secondary Slave	: <b>Auto</b>	0	0	0	0	0	0	<b>Auto</b>														
Drive A : 1.44M, 3.5 in.				<table border="1"> <tr> <td>Base Memory</td> <td>:</td> <td>640K</td> </tr> <tr> <td>Extended Memory</td> <td>:</td> <td>31744K</td> </tr> <tr> <td>Other Memory</td> <td>:</td> <td>384K</td> </tr> <tr> <td colspan="2"><hr/></td> <td></td> </tr> <tr> <td>Total Memory</td> <td>:</td> <td>32768K</td> </tr> </table>				Base Memory	:	640K	Extended Memory	:	31744K	Other Memory	:	384K	<hr/>			Total Memory	:	32768K
Base Memory	:	640K																				
Extended Memory	:	31744K																				
Other Memory	:	384K																				
<hr/>																						
Total Memory	:	32768K																				
Drive B : None																						
Floppy 3 Mode Support : Disabled																						
Video : EGA/VGA																						
Halt On : All Errors																						
ESC : Quit		↑ ↓ → ← : Select Item		PU/PD/+/- : Modify																		
F1 : Help		(Shift) F2 : Change Color																				

*Figure 2: Standard CMOS Setup*

*NOTE: If the hard disk Primary Master/Slave and Secondary Master/Slave are set to Auto, then the hard disk size and model will be auto-detected.*

*NOTE: The “Halt On:” field is used to determine when to halt the system by the BIOS if an error occurs.*

*NOTE: Floppy 3 Mode support is a mode used to support a special 3.5” drive used in Japan. This is a 3.5” disk that stores only 1.2 MB, the default setting for this is disabled.*

## 4-2 BIOS Features Setup

Selecting the “BIOS FEATURES SETUP” option in the CMOS SETUP UTILITY menu allows users to change system related parameters in the displayed menu. This menu shows all of the manufacturer’s default values for the EP-6VBE.

Pressing the [F1] key will display a help message for the selected item.

ROMPCI/ISABIOS(2A6LFPAB)  
 BIOSFEATURESETUP  
 AWARD SOFTWARE, INC.

Virus Warning	: Disabled	Video BIOS	Shadow	: Enabled
CPU Internal Cache	: Enabled	C8000-CBFFF	Shadow	: Disabled
External Cache	: Enabled	CC000-CFFFF	Shadow	: Disabled
CPU L2 Cache ECC Checking	: Disabled	D0000-D3FFF	Shadow	: Disabled
Processor Number Feature	: Enabled	D4000-D7FFF	Shadow	: Disabled
Quick Power On Self Test	: Enabled	D8000-DBFFF	Shadow	: Disabled
Boot Sequence	: A, C, SCSI	DC000-DFFFF	Shadow	: Disabled
Swap Floppy Drive	: Disabled			
Boot Up Floppy Seek	: Enabled			
Boot Up NumLock Status	: On			
Gate A20 option	: Fast			
Memory Parity/ECC Check	: Disabled			
Typematic Rate Setting	: Disabled			
Typematic Rate (Chars/Sec)	: 6			
Type matic Delay (Msec)	: 250			
Security Option	: Setup			
PCI/VGA Palette Snoop	: Disabled			
OS Select For DRAM > 64MB	: Non-OS2			
HDD S.M.A.R.T. capability	: Disabled			
Report NO FDD For Win 95	: Yes			
		Esc	: Quit	↑ ↓ → ← : Select Item
		F1	: Help	PU/PD/+/- : Modify
		F5	: Old Values	(Shift) F2 : Color
		F7	: Load Setup Defaults	

Figure 3: BIOS Features Setup

**Virus Warning:** During and after the system boots up, any attempt to write to the boot sector or partition table of the hard disk drive will halt the system and an error message will appear.

You should then run an anti-virus program to locate the virus. Keep in mind that this feature protects only the boot sector, not the entire hard drive.

The default value is Disabled.

**Enabled:** Activates automatically when the system boots up causing a warning message to appear when anything attempts to access the boot sector.

**Disabled:** No warning message will appear when anything attempts to access the boot sector.

*Note: Many disk diagnostic programs that access the boot sector table can trigger the virus warning message. If you plan to run such a program, we recommend that you first disable the virus warning.*

**CPU Internal Cache:** This controls the status of the processor's internal cache area. The default is Enabled.

**Enabled:** This activates the processor's internal cache thereby increasing performance.

**Disabled:** This deactivates the processor's internal cache thereby lowering performance.

**External (L2) Cache:** This controls the status of the external (L2) cache area. The default is Enabled.

**Enabled:** This activates the motherboard's L2 cache thereby increasing performance.

**Disabled:** This deactivates the motherboard's L2 cache thereby lowering performance.

**CPU L2 Cache ECC Checking:** This control if the CPU's L2 Cache will support Error Checking and Correcting (ECC). The default is Disabled.

**Enabled:** Enables ECC support for the CPU's L2 cache. Performance will decrease 2% ~ 4%.

**Disabled:** Disables ECC support for the CPU's L2 cache.

**Processor Number Feature:** Pentium III or later CPU new feature. The default is Enabled.

**Enabled:** Processor serial number readable.

**Disabled:** Processor serial number disabled.

**Quick Power On Self Test:** This category speeds up the Power On Self Test (POST). The default is Enabled.

**Enabled:** This setting will shorten or skip of the items checked during POST.

**Disabled:** Normal POST.

**Boot Sequence:** This category determines which drive is searched first by the O/S (Operating System). The default is A,C,SCSI.

*The following is your list of options:*

*[A, C, SCSI] - [C, A, SCSI] - [C, CD-ROM, A] - [CD-ROM, C, A]*

*[D, A, CD-ROM], [E, A, CD-ROM] - [F, A, CD-ROM] - [SCSI, A, C]*

*[SCSI C, A] - [C Only]*

**Swap Floppy Drive:** This will swap your physical drive letters A & B if you are using two floppy disks. The default is Disabled.

**Enabled:** Floppy A & B will be swapped under the O/S.

**Disabled:** Floppy A & B will be not swapped.

**Boot Up Floppy Seek:** During Power-On-Self-Test (POST), BIOS will determine if the floppy disk drive installed is 40 or 80 tracks. Only 360K type is 40 tracks while 760K, 1.2MB and 1.44MB are all 80 tracks. The default is Enabled.

**Enabled:** The BIOS will search the floppy disk drive to determine if it is 40 or 80 tracks.

**Disabled:** The BIOS will not search for the type of floppy disk drive by track number.

*Note: BIOS can not tell the difference between 720K, 1.2MB and 1.44MB drive types as they are all 80 tracks.*

**Boot Up NumLock Status:** This controls the state of the NumLock key when the system boots. The default is On.

**On:** The keypad acts as a 10-key pad.

**Off:** The keypad acts like the cursor keys.

**Gate A20 Option:** This refers to the way the system addresses memory above 1MB (extended memory). The default is Fast.

**Normal:** The A20 signal is controlled by the keyboard controller or chipset hardware.

**Fast:** The A20 signal is controlled by Port 92 or chipset specific method.

**Memory Parity/ECC Check:** If the DRAM chip in your system support Parity/ECC check, select Enabled.

**Typematic Rate Setting:** This determines the keystrokes repeat rate. The default is Disabled.

**Enabled:** Allows typematic rate and typematic delay programming.

**Disabled:** The typematic rate and typematic delay will be controlled by the keyboard controller in your system.

**Typematic Rate (Chars/Sec):** This is the number of characters that will be repeated by a keyboard press. The default is 6.

<i>6: 6 characters per second.</i>	<i>8: 8 characters per second.</i>
<i>10: 10 characters per second.</i>	<i>12: 12 characters per second.</i>
<i>15: 15 characters per second.</i>	<i>20: 20 characters per second.</i>
<i>24: 24 characters per second.</i>	<i>30: 30 characters per second.</i>

**Typematic Delay (msec):** This setting controls the time between the first and the second character displayed by typematic auto-repeat. The default is 250.

*250: 250 msec.*  
*500: 500 msec.*  
*750: 750 msec.*  
*1000: 1000 msec.*

**Security Option:** This category allows you to limit access to the System and Setup, or just to Setup. The default is Setup.

**System:** The system will not boot and the access to Setup will be denied if the correct password is not entered at the prompt.

**Setup:** The system will boot; but the access to Setup will be denied if the incorrect password is not entered at the prompt.

**PCI/VGA Palette Snoop:** This field controls the ability of a primary PCI VGA controller to share a common palette (When a snoop write cycles) with an ISA video card. The default is Disabled.

**Enabled:** If an ISA card is connected to a PCI VGA card via the VESA connector, and that ISA card connects to a VGA monitor, then that ISA card uses the RAMDAC of the PCI card.



**OS Select For DRAM > 64MB:** Some operating systems require special handling. Use this option only if your system has greater than 64MB of memory. The default is Non-OS2.

**OS2:** Select this if you are running the OS/2 operating system with greater than 64MB of RAM.

**Non-OS2:** Select this for all other operating systems and configurations.

**HDD S.M.A.R.T Capability:** Enable SMART hard drive functions for compatible hardware. The default is Disabled.

**Enabled:** S.M.A.R.T features are available.

**Disabled:** S.M.A.R.T features will not be available.

**Report No FDD For WIN95:** This option allows BIOS to indicate whether WIN95 is with FDD or not. The Default value is NO.

*NO: Report No FDD for WIN95.*

*YES: Report FDD for WIN95*

**Video BIOS Shadow:** This option allows video BIOS to be copied into RAM. Video Shadowing will increase the video performance of your system. The default is Enabled.

**Enabled:** Video shadow is enabled.

**Disabled:** Video shadow is disabled.

**C8000 - CBFFF Shadow:**

**CC000 - CFFFF Shadow:**

**D0000 - D3FFF Shadow:**

**D4000 - D7FFF Shadow:**

**D8000 - DBFFF Shadow:**

**DC000 - DFFFF Shadow:**

These categories determine whether ROMs from option cards will be copied into RAM. This will be in 16K byte or 32K byte units, and the size will depend on chipset of the option card.

**Enabled:** Optional shadow is enabled.

**Disabled:** Optional shadow is disabled.

## 4-3 Chipset Features Setup

Choose the "CHIPSET FEATURES SETUP" in the CMOS SETUP UTILITY menu to display following menu.

ROMPCI/ISABIOS(2A6LFPAB)  
 CHIPSETFEATURESETUP  
 AWARD SOFTWARE, INC.

Bank 0/1 DRAM Timing	: Fast	Auto Detect DIMM/PCI Clk	: Enabled
Bank 2/3 DRAM Timing	: Fast	Spread Spectrum	: Disabled
Bank 4/5 DRAM Timing	: Fast	CPU Host Clock (CPU/PCI)	: Default
SDRAM Cycle Length	: 3		
DRAM Clock	: Host CLK		
Memory Hole At 15Mb Addr.	: Disabled		
Read Around Write	: Disabled		
Concurrent PCI/Host	: Enabled		
System BIOS Cacheable	: Disabled		
Video BIOS Cacheable	: Enabled		
Video RAM Cacheable	: Enabled		
AGP Aperture Size (MB)	: 64M		
AGP -2X Mode	: Enabled		
CPU Hardwired IOQ Size	: 4-Level		
Delay DRAM Read Latch	: 2.0ns		
		Esc : Quit	↑ ↓ → ← : Select Item
		F1 : Help	PU/PD/+/- : Modify
		F5 : Old Values	(Shift) F2 : Color
		F7 : Load Setup Defaults	

Figure 4: Chipset Features Setup

**Bank 0/1, 2/3, 4/5 DRAM Timing:** This value in this field is set by the system board manufacturer, depending on whether the board has paged DRAMs or EDO (extended data output) DRAMs.

The Choice: Bank 0/1, 2/3, 4/5.

**SDRAM Cycle length:** This setting defines the CAS timing parameter of the SDRAM in terms of clocks. The default is 3.

2: Provides faster memory performance.

3: Provides better memory compatibility.

**Memory Hole at 15Mb Addr.:** You can reserve this memory area for the use of ISA adaptor ROMs. The default is Disabled.

**Enabled:** This field enables the main memory (15~16MB) to remap to ISA BUS.

**Disabled:** Normal Setting.

*Note: If this feature is enabled you will not be able to cache this memory segment.*

**Read Around write:** DRAM optimization feature: If a memory read is addressed to a location whose latest write is being held in a buffer contents, and the read is not sent to the DRAM.

The Choice: Enabled, Disabled

**Concurrent PCI/Host:** When disabled, CPU bus will be occupied during the entire PCI operation period.

The Choice: Enabled, Disabled

**System BIOS Cacheable:** This allows you to copy your BIOS code from slow ROM to fast RAM. The default is Disabled.

**Enabled:** The option will improve system performance. However, if any program writes to this memory area, a system error may result.

**Disabled:** System BIOS non-cacheable.

**Video BIOS Cacheable:** This option copies the video ROM BIOS to fast RAM (C0000h to C7FFFh). The default is Enabled.

**Enabled:** Enables the Video BIOS Cacheable to speed up the VGA Performance.

**Disabled:** Will not use the Video BIOS Cacheable function.

**Video RAM Cacheable:** This option allows the CPU to cache read/writes of the video RAM. The default is Enabled.

**Enabled:** This option allows for faster video access.

**Disabled:** Reduced video performance.

**AGP Aperture Size:** The amount of system memory that the AGP card is allowed to share. The default is 64.

*4: 4MB of systems memory accessible by the AGP card.*

*8: 8MB of systems memory accessible by the AGP card.*

*16: 16MB of systems memory accessible by the AGP card.*

*32: 32MB of systems memory accessible by the AGP card.*

*64: 64MB of systems memory accessible by the AGP card.*

*128: 128MB of systems memory accessible by the AGP card.*

*256: 256MB of systems memory accessible by the AGP card.*

**Auto Detect DIMM/PCI Clk:** Allows you to stop DIMM/PCI Clock drive when the DIMM site or PCI Slot are not plug. This item may help reduce EMI.

The default is Enabled.

**Enabled:** Provides unused DIMM/PCI to stop.

**Disabled:** Provides the clock generator always driving.

**Spread Spectrum :** Allows you to active the Spread Spectrum Modulation function for reduce EMI. (Note: When Enabled the item that performance will be impacted). The default is Disabled.

**Enabled:** Provides the Spread Spectrum function from clock generator.

**Disabled:** NO Spread Spectrum function.

**CPU Host Clock (CPU/PCI):** Allows the external clock to be modified depending upon what FSB has been selected. Should not be used to clock processor faster than it was designed for. The default is Default.

## 4-4 Power Management Setup

Choose the "POWER MANAGEMENT SETUP" in the CMOS SETUP UTILITY to display the following screen. This menu allows the user to modify the power management parameters and IRQ signals. In general, these parameters should not be changed unless it's absolutely necessary.

ROMPCI/ISA BIOS (2A6LFPAB)  
POWERMANAGEMENTSETUP  
AWARD SOFTWARE, INC.

ACPI Function	: Enabled	Primary INTR	: ON
Power Management	: User Define	IRQ3 (COM 2)	: Primary
PM Control by APM	: Yes	IRQ4 (COM 1)	: Primary
Video off After	: Suspend	IRQ5 (LPT 2)	: Primary
Video off Method	: V/H SYNC+Blank	IRQ6 (Floppy Disk)	: Primary
Modem Use IRQ	: 3	IRQ7 (LPT 1)	: Primary
Soft-off by PWRBTN	: Delay 4 Sec	IRQ8 (RTC Alarm)	: Disabled
HDD Power Down	: Disabled	IRQ9 (IRQ2 Redir)	: Secondary
Doze Mode	: Disabled	IRQ10 (Reserved)	: Secondary
Suspend Mode	: Disabled	IRQ11 (Reserved)	: Secondary
** PM Events **		IRQ12 (PS/2 Mouse)	: Primary
VGA	: OFF	IRQ13 (Coprocessor)	: Primary
LPT & COM	: LPT/COM	IRQ14 (Hard Disk)	: Primary
HDD & FDD	: ON	IRQ15 (Reserved)	: Disabled
DMA/master	: OFF	Esc : Quit	↑ ↓ → ← : Select Item
Power Loss Recovery	: Disabled	F1 : Help	PU/PD/+/- : Modify
Modem Ring Resume	: Disabled	F5 : Old Values	(Shift) F2 : Color
RTC Alarm Resume	: Disabled	F7 : Load Setup Defaults	

Figure 5: Power Management Setup

**ACPI Function:** This option allows you to select ACPI Function. The default is Enabled.

**Enabled:** Support ACPI function for new O.S

**Disabled:** No Support ACPI function.

You can only change the content of Doze Mode, Standby Mode, and Suspend Mode when the Power Management is set to 'User Define'.

**Power Management:** Use this to select your Power Management selection. The default is User define.

**Disabled:** The system operates in NORMAL conditions (Non-GREEN), and the Power Management function is disabled.

**Max. saving:** Maximum power savings. Inactivity period is 1 minute in each mode.

**Min. saving:** Minimum power savings. Inactivity period is 1 hour in each mode.

**User define:** Allows user to define PM Timers parameters to control power saving mode.

**PM controlled APM:** This option shows whether or not you want the Power Management to be controlled the Advanced Power Management (APM). The default is Yes.

**Yes:** APM controls your PM

**No:** APM does not control your PM

**Video Off After:** Tells you what time frame that the video will be disabled under current power management settings. The default is Standby.

**Standby:** Video powers off after time shown in standby mode setting.

**Doze:** Video powers off after time shown in doze mode setting.

**Suspend:** Video powers off after time shown in suspend mode setting.

**N/A:** Video power off not controlled by power management.

**Video Off Method:** This option allows you to select how the video will be disabled by the power management. The default is V/H Sync + Blank

**V/H Sync + Blank:** System turns off vertical and horizontal synchronization ports and writes blanks to the video buffer.

**DPMS:** Select this option if your monitor supports the Display Power Management Signaling (DPMS) standard of the Video Electronics Standards Association (VESA). Use the software supplied for your video subsystem to select video power management values.

**Blank Screen:** System only writes blanks to the video buffer.

**MODEM Use IRQ:** Name the interrupt request (IRQ) line assigned to the modem (if any) on your system. Activity of the selected IRQ always awakens the system. Default is IRQ 3.

**N/A:** No IRQ is used.      **3:** IRQ 3

**4:** IRQ 4                      **5:** IRQ 5

**7:** IRQ 7                      **9:** IRQ 9

**10:** IRQ 10                   **11:** IRQ 11

**Soft-Off by PWRBTN:** Use this to select your soft-off function.

The default is Delay 4 sec.

**Instant Off:** Turns off the system instantly.

**Delay 4 Second :** Turns off the system after a 4 second delay. If momentary press of button, the system will go into Suspend Mode. Press the power button again to take system out of Suspend Mode.

**HDD Power Down:** HDD Standby timer can be set from 1 to 15 minute(s).

**Doze Mode:** The “Doze” mode timer starts to count when no “PM events” have occurred.

**Suspend Mode:** This function works only when the Pentium II Processor is installed. The timer starts to count when “System Standby” mode timer is timed out and no “PM Events” are occurring. Valid range is from 1 minute up to 1 hour.

**VGA:** When set to *On* (default), any event occurring at a VGA port will awaken a system which has been powered down.

**LPT & COM:** When set to *On* (default), any event occurring at a COM(serial)/LPT (printer) port will awaken a system which has been powered down.

**HDD & FDD:** When set to *On* (default), any event occurring at a hard or floppy drive port will awaken a system which has been powered down.

**DMA/master:** When set to *On* (default), any event occurring to the DMA controller will awaken a system which has been powered down.

**Power Loss Recovery:** If the power to the system is cut off, the system will turn itself back on with no user intervention. The default is Disabled.

**Enabled:** The system will power back on after a power interruption.

**Disabled:** The system will stay off after a power interruption.

**Modem Ring Resume:** When set to *Enabled*, any event occurring to the Modem Ring will awaken a system which has been powered down.

**RTC Alarm Resume:** When set to *Enable rtc alarm resume*, you could set the date (of month) and timer (hh:mm:ss), any event occurring at will awaken a system which has been powered down.

**Primary INTR:** When set to *On* (default), any event occurring at will awaken a system which has been powered down.

## 4-5 PNP/PCI Configuration

The PNP/PCI configuration program is for the user to modify the PCI/ISA IRQ signals when various PCI/ISA cards are inserted in the PCI or ISA slots.

**WARNING:** *Conflicting IRQ's may cause the system to not find certain devices.*

ROMPCI/ISABIOS(2A6LFPAB)  
 PNP/PCICONFIGURATION  
 AWARD SOFTWARE, INC.

PNP OS Installed	: NO	CPU to PCI Write Buffer	: Enabled
Resources Controlled By	: Manual	PCI Dynamic Bursting	: Enabled
Reset Configuration Data	: Disabled	PCI Master 0 WS Write	: Enabled
IRQ-3 assigned to	: PCI/ISA PnP	PCI Delay Transaction	: Disabled
IRQ-4 assigned to	: PCI/ISA PnP	PCI#2 Access #1 Retry	: Disabled
IRQ-5 assigned to	: PCI/ISA PnP	AGP Master 1 WS Write	: Enabled
IRQ-7 assigned to	: PCI/ISA PnP	AGP Master 1 WS Read	: Disabled
IRQ-9 assigned to	: PCI/ISA PnP	PCI IRQ Activated By	: Level
IRQ-10 assigned to	: PCI/ISA PnP	Assign IRQ For USB	: Enabled
IRQ-11 assigned to	: PCI/ISA PnP	Assign IRQ For VGA	: Enabled
IRQ-12 assigned to	: PCI/ISA PnP	Solt 1 Use IRQ No.	: Auto
IRQ-14 assigned to	: PCI/ISA PnP	Solt 2 Use IRQ No.	: Auto
IRQ-15 assigned to	: PCI/ISA PnP	Solt 3 Use IRQ No.	: Auto
DMA-0 assigned to	: PCI/ISA PnP	Solt 4 Use IRQ No.	: Auto
DMA-1 assigned to	: PCI/ISA PnP		
DMA-3 assigned to	: PCI/ISA PnP	Esc : Quit	↑ ↓ → ← : Select Item
DMA-5 assigned to	: PCI/ISA PnP	F1 : Help	PU/PD/+/- : Modify
DMA-6 assigned to	: PCI/ISA PnP	F5 : Old Values	(Shift) F2 : Color
DMA-7 assigned to	: PCI/ISA PnP	F7 : Load Setup Defaults	

Figure 6: PCI Configuration Setup

**PNP OS Installed:** Do you have a PNP OS installed on your system. The default is No.

**Yes:** Select if you are using a PNP OS.

**No:** Select if your OS does not support PNP.

**Resources Controlled By:** Who controlled the system PNP/PCI resources. The default is Manual.

**Manual:** PNP Card's resources will be controlled manually. You can set which IRQ-X and DMA-X are assigned to PCI/ISA PnP or Legacy ISA Cards.

**Auto:** If your ISA card and PCI card are all PNP cards, BIOS will assign the interrupt resource automatically.



**Reset Configuration Data:** This setting allows you to clear ESCD data.

The default is Disabled

**Disabled:** Normal Setting.

**Enabled:** If you have plugged in some Legacy cards to the system and they were recorded into ESCD (Extended System Configuration Data), you can set this field to Enabled in order to clear ESCD.

**IRQ-3 to IRQ-15 assigned to:** These settings allow IRQ's to be reserved for Legacy ISA device use exclusively or be available for use with PNP devices. These options are only displayed if "Resources Controlled By" is set to manual.

**DMA-0 to DMA-7 assigned to:** These settings allow DMA's to be reserved for Legacy ISA device use exclusively or be available for use with PNP devices. These options are only displayed if "Resources Controlled By" is set to manual.

**CPU to PCI Write Buffer:** When enabled, up to four D words of data can be written to the PCI bus without interrupting the CPU. When disabled, a write buffer is not used and the CPU read cycle will not be completed until the PCI bus signals that it is ready to receive the data.

The Choice: Enabled, Disabled.

**PCI Dynamic Bursting:** When Enabled, data transfers on the PCI bus, where possible, make use of the high-performance PCI bust protocol, in which graeater amounts of data are transferred at a single command.

The Choice: Enabled, Disabled.

**PCI Master 0 WS Write:** When Enabled, writes to the PCI bus are command with zero wait states.

The Choice: Enabled, Disabled.

**PCI Delay Transaction:** The chipset has an embedded 32-bit posted write buffer to support delay transactions cycles. Select Enabled to support compliance with PCI specification version 2.1.

The Choice: Enabled, Disabled.

**PCI #2 Access #1 Retry:** This item allows you enabled/disable the PCI #2 Access #1 Retry.

The Choice: Enabled, Disabled.

---

**Assign IRQ For USB:** This item allows BIOS to assign whether IRQ is with USB or not. If you have not connect the USB device. Can release the IRQ for other device. The default is Enabled.

**Enabled:** Provides IRQ for USB device.

**Disabled:** Release IRQ for other device.

**Slot 1 to Slot 4 Use IRQ No:** These settings allow the user to specify what IRQ will be assigned to PCI devices in the chosen slot. Options available: Auto,3,4,5, 7,9,10,11,12,14 & 15. The defaults are Auto.

## **4-6 Load Setup Defaults**

The “LOAD SETUP DEFAULTS” function loads the system default data directly from ROM and initializes the associated hardware properly. This function will be necessary only when the system CMOS data is corrupted.

## 4-7 Integrated Peripherals

ROM PCI/ISA BIOS(2A6LFPAB)  
 INTEGRATEDPERIPHERALS  
 AWARD SOFTWARE, INC.

Onboard Primary PCI IDE	: Enabled	Onboard Serial Port 2	: 2F8/IRQ3
Onboard Secondary PCI IDE	: Enabled	UART Mode Select	: Normal
IDE Prefetch Mode	: Enabled	RxD, TxD Active	: Hi, Lo
IDE HDD Block Mode	: Enabled	IR Transmitting delay	: Enabled
Primary Master PIO	: Auto	Onboard Parallel Port	: 378/IRQ7
Primary Slave PIO	: Auto	Onboard Parallel Mode	: ECP / EPP
Secondary Master PIO	: Auto	ECP Mode Use DMA	: 3
Secondary Slave PIO	: Auto	EPP Mode Select	: EPP1.7
Primary Master UDMA	: Auto	OnChip USB	: Enabled
Primary Slave UDMA	: Auto	USB Keyboard Support	: Disabled
Secondary Master UDMA	: Auto		
Secondary Slave UDMA	: Auto		
Init Display First	: PCI Slot		
POWER ON Function	: Hot Key		
KB Power ON Password	: Enter	Esc : Quit	↑ ↓ → ← : Select Item
Hot Key Power ON	: Ctrl-F1	F1 : Help	PU/PD/+/- : Modify
KBC Input Clock	: 12MHz	F5 : Old Values	(Shift) F2 : Color
Onboard FDC Controller	: Enabled	F7 : Load Setup Defaults	
Onboard Serial Port 1	: 3F8/IRQ4		

Figure 8: Integrated Peripherals

**Note:** If you do not use the Onboard IDE connector, then you will need to set Onboard Primary PCI IDE: Disabled and Onboard Secondary PCI IDE: Disabled

**Note:** The Onboard PCI IDE cable should be equal to or less than 18 inches (45 cm.).

**Onboard Primary PCI IDE:** The default value is Enabled.

**Enabled:** Enables Onboard IDE primary port.

**Disabled:** Disables Onboard IDE primary port.

**Onboard Secondary PCI IDE:** The default is Enabled.

**Enabled:** Enables Onboard IDE secondary port.

**Disabled:** Disables Onboard IDE secondary port.

**IDE HDD Block Mode:** IDE Block Mode allows the controller to access blocks of sectors rather than a single sector at a time. The default is Enabled.

**Enabled:** Enabled IDE HDD Block Mode. Provides higher HDD transfer rates.

**Disabled:** Disable IDE HDD Block Mode.

**IDE Primary Master PIO:** The default is Auto.

**Auto:** BIOS will automatically detect the Onboard Primary Master PCI IDE HDD Accessing mode.

**Mode 0~4:** Manually set the IDE Programmed interrupt mode.

**IDE Primary Slave PIO:** The default is Auto.

**Auto:** BIOS will automatically detect the Onboard Primary Slave PCI IDE HDD Accessing mode.

**Mode 0~4:** Manually set the IDE Programmed interrupt mode.

**IDE Secondary Master PIO:** The default is Auto.

**Auto:** BIOS will automatically detect the Onboard Secondary Master PCI IDE HDD Accessing mode.

**Mode 0~4:** Manually set the IDE Programmed interrupt mode.

**IDE Secondary Slave PIO:** The default is Auto.

**Auto:** BIOS will automatically detect the Onboard Secondary Slave PCI IDE HDD Accessing mode.

**Mode 0~4:** Manually set the IDE Programmed interrupt mode.

**IDE Primary Master UDMA:** This allows you to select the mode of operation for the hard drive. The default is Auto.

**Auto:** The computer will select the optimal setting.

**Disabled:** The hard drive will run in normal mode.

**IDE Primary Slave UDMA:** This allows you to select the mode of operation for the hard drive. The default is Auto.

**Auto:** The computer will select the optimal setting.

**Disabled:** The hard drive will run in normal mode.

**IDE Secondary Master UDMA:** This allows you to select the mode of operation for the hard drive. The default is Auto.

**Auto:** The computer will select the optimal setting.

**Disabled:** The hard drive will run in normal mode.

**IDE Secondary Slave UDMA:** This allows you to select the mode of operation for the hard drive. The default is Auto.

**Auto:** The computer will select the optimal setting.

**Disabled:** The hard drive will run in normal mode.

**Init Display First:** If two video cards are used (1 AGP and 1 PCI) this specifies which one will be the primary display adapter. The default is PCI Slot.

**PCI Slots:** PCI video card will be primary adapter.

**AGP:** AGP video card will be primary adapter.

**Power On Function:** There are “**Button Only**”, “**Hot Key**” and “**Any key**” can be chosen by this field that allows users to select one of these various functions as Power On Method for their requirement. The default value in this selection is “Hot Key”. (Ctrl-F1)

**Hot Key:** User can press “**Control Key**” (Ctrl) and “**Function Key**” (from F1 to F12) individually to power on the system. The interval between “Ctrl” key and function Key (F1-F12) must be short.

**Anykey:** Press anykey to power on the system.

**Button Only:** This power on function controlled by J3 (pw-on.) Use Power On Button to power on the system.

**Password:** User can Power On the System by password, the password can be entered from 1 to 5 characters. The maximum of password is 5 characters. If user forget / lost the password, please go into BIOS setting to change the Power On Method, or keyin another words as password instead of original one.

**KB Power On Password:** When the option of “Power On Function” is password selected, user uses the item to key in password.

**Hot Key Power On:** Use this option with the above “Power On Function” to set a combination of keys that can be used to power the system on. The default is Ctrl-F1.

**Options:** Ctrl-F1, Ctrl-F2, Ctrl-F3, Ctrl-F4, Ctrl-F5, Ctrl-F6, Ctrl-F7, Ctrl-F8, Ctrl-F9, Ctrl-F10, Ctrl-F11, and Ctrl-F12.

**KBC input clock:** This sets the keyboard clock value. The default is 12 MHz.

**Options:** 6, 8, 12, 16 are the available choices.

**Onboard FDC Controller:** This controls the state of the onboard floppy controller. The default value is Enabled.

**Enabled:** Enable the Onboard Winbond Chips’s floppy drive interface controller.

**Disabled:** Disable the Onboard Winbond Chip’s floppy drive interface controller.

**Onboard Serial Port 1:** This field allows the user to configure the 1st serial port. The default is 3F8/IRQ4.

**AUTO:** Enable Onboard Serial port 1 and address is Auto adjusted.

**COM1:** Enable Onboard Serial port 1 and address is 3F8H/IRQ4.

**COM2:** Enable Onboard Serial port 1 and address is 2F8H/IRQ3.

**COM3:** Enable Onboard Serial port 1 and address is 3E8H/IRQ4.

**COM4:** Enable Onboard Serial port 1 and address is 2E8H/IRQ3.

**Disabled:** Disable Onboard SMC CHIP's Serial port 1.

**Onboard Serial Port 2:** This field allows the user to configure the 2nd serial port. The default is 2F8/IRQ3.

**AUTO:** Enable Onboard Serial port 2 and address is Auto adjusted.

**COM1:** Enable Onboard Serial port 2 and address is 3F8H/IRQ4.

**COM2:** Enable Onboard Serial port 2 and address is 2F8H/IRQ3.

**COM3:** Enable Onboard Serial port 2 and address is 3E8H/IRQ4.

**COM4:** Enable Onboard Serial port 2 and address is 2E8H/IRQ3.

**Disabled:** Disable Onboard SMC CHIP's Serial port 2.

**UART Mode Select:** The mode of the IR Controller. The default is Normal.

**IrDA:** Support a Serial Infrared Interface IrDA.

**ASKIR:** Support a Sharp Serial Infrared Interface formats.

**Normal:** The IRRX and IRTX pins of IR function in normal condition.

**RxD, RxD Active:** This field configures the receive and transmit signals generated from the IR port. The default is Hi Lo (when UART Mode Select is not set to Normal).

**Options:** Hi Hi, Hi Lo, Lo Hi, and Lo Lo.

**IR Transmitting delay:** The default is Enabled (when UART Mode Select is not set to Normal).

**Options:** Enabled and Disabled.

**Onboard Parallel port:** This field allows the user to configure the LPT port. The default is 378H / IRQ7.

**378H:** Enable Onboard LPT port and address is 378H and IRQ7.

**278H:** Enable Onboard LPT port and address is 278H and IRQ5.

**3BCH:** Enable Onboard LPT port and address is 3BCH and IRQ7.

**Disabled:** Disable Onboard Winbond Chip's LPT port.

**Parallel Port Mode:** This field allows the user to select the parallel port mode. The default is ECP+EPP.

**Normal:** Standard mode. IBM PC/AT Compatible bidirectional parallel port.

**EPP:** Enhanced Parallel Port mode.

**ECP:** Extended Capabilities Port mode.

**EPP+ECP:** ECP Mode & EPP Mode.

**ECP Mode USE DMA:** This field allows the user to select DMA1 or DMA3 for the ECP mode. The default is DMA3.

**DMA1:** This field selects the routing of DMA1 for the ECP mode.

**DMA3:** This field selects the routing of DMA3 for the ECP mode.

**ECP Mode Select:** This item allows you to determine the IR transfer mode of onboard I/O chip.

**options:** EPP1.9, EPP1.7.

**USB Keyboard Support:** This controls the activation status of an optional USB keyboard that may be attached. The default is Disabled.

**Enabled:** Enable USB keyboard support.

**Disabled:** Disable USB keyboard support.

## **4-8 Change Supervisor or User Password**

---

To change the password, choose the “SUPERVISOR PASSWORD or USER PASSWORD” option from the CMOS SETUP UTILITY menu and press [Enter].

*Note: Either “Setup” or “System” must be selected in the “Security Option” of the BIOS FEATURES SETUP menu.*

1. If CMOS is corrupted or the option was not used, a default password stored in the ROM will be used. The screen will display the following message:

Enter Password:

Press the [Enter] key to continue after the proper password is given.

2. If the CMOS is corrupted or the option was used earlier and the user wishes to change the default password, the SETUP UTILITY will display a message and ask for a confirmation.

Confirm Password:

3. After pressing the [Enter] key (ROM password if the option was not used) or current password (user-defined password), the user can change the password and store new one in CMOS RAM. A maximum of 8 characters can be entered.



### 4-9 IDE HDD Auto Detection

The “IIDE HDD auto detection” utility is a very useful tool, especially when you do not know which kind of hard disk type you are using. You can use this utility to detect the correct disk type installed in the system automatically. But now you can set HARD DISK TYPE to Auto in the STANDARD CMOS SETUP. You don’t need the “IIDE HDD AUTO DETECTION” utility. The BIOS will Auto-detect the hard disk size and model on display during POST.

ROMPCI/ISABIOS(2A6LFPAB)  
 CMOSSETUPUTILITY  
 AWARD SOFTWARE, INC.

HARD DISKS	TYPE	SIZE	CYLS	HEADS	PRECOMP	LANDZONE	SECTORS	MODE
Primary Master :								
Select Secondary Slave Option (N=Skip) : N								
OPTIONSSIZE	CYLS	HEAD	PRECOMP	LANDZ	SECTOR	MODE		
2 (Y)	4310	524	255	0	14847	63	LBA	
1	4310	14848	9	65535	14847	63	NORMAL	
3	4310	928	144	65535	14847	63	LARGE	
Note: Some OSes (like SCO-UNIX) must use NORMAL for installation								
ESC : Skip								

Figure 8: IDE HDD Auto Detection

**Note: HDD Modes**

The Award BIOS supports 3 HDD modes : NORMAL, LBA & LARGE NORMAL mode

Generic access mode in which neither the BIOS nor the IDE controller will make any transformations during accessing.

The maximum number of cylinders, head & sectors for NORMAL mode are 1024, 16 & 63.

- no. Cylinder (1024)
  - x no. Head ( 16)
  - x no. Sector ( 63)
  - x no. per sector ( 512)
- 528 Megabytes

If user set his HDD to NORMAL mode, the maximum accessible HDD size will be 528 Megabytes even though its physical size may be greater than that!

**LBA (Logical Block Addressing) mode:** A new HDD accessing method to overcome the 528 Megabyte bottleneck. The number of cylinders, heads & sectors shown in setup may not be the number physically contained in the HDD. During HDD accessing, the IDE controller will transform the logical address described by sector, head & cylinder into its own physical address inside the HDD. The maximum HDD size supported by LBA mode is 8.4 GigaBytes which is obtained by the following formula:

$$\begin{aligned}
 &\text{no. Cylinder} && (1024) \\
 &x \text{ no. Head} && ( 255) \\
 &x \text{ no. Sector} && ( 63) \\
 &\underline{x \text{ bytes per sector}} && \underline{( 512)} \\
 &&& 8.4 \text{ GigaBytes}
 \end{aligned}$$

**LARGE mode:** Extended HDD access mode supported by Award Software.

Some IDE HDDs contain more than 1024 cylinder without LBA support (in some cases, user do not want LBA). The Award BIOS provides another alternative to support these kinds of LARGE mode.

<u>CYLS</u>	<u>HEADS</u>	<u>SECTOR</u>	<u>MODE</u>
1120	16	59	NORMAL
560	32	59	LARGE

BIOS tricks DOS (or other OS) that the number of cylinders is less than 1024 by dividing it by 2. At the same time, the number of heads is multiplied by 2. A reverse transformation process will be made inside

INT 12h in order to access the right HDD address!

**Maximum HDD size:**

$$\begin{aligned}
 &\text{no. Cylinder} && (1024) \\
 &x \text{ no. Head} && ( 32) \\
 &x \text{ no. Sector} && ( 63) \\
 &\underline{x \text{ bytes per sector}} && \underline{( 512)} \\
 &&& 1 \text{ GigaByte}
 \end{aligned}$$

*Note: To support LBA or LARGE mode of HDDs, there must be some software involved. All the software is located in the Award HDD Service Routine (INT 13h). It may fail to access a HDD with LBA (LARGE) mode selected if you are running under an Operating System which replaces the whole INT 13h.*

UNIX operating systems do not support either LBA or LARGE and must utilize the Standard mode. UNIX can support drives larger than 528MB.

## **4-10 Save & Exit Setup**

The “SAVE & EXIT SETUP” option will bring you back to the boot up procedure with all the changes you just recorded in the CMOS RAM.

## **4-11 Exit Without Saving**

The “EXIT WITHOUT SAVING” option will bring you back to normal boot up procedure without saving any data into CMOS RAM.

**All old data in the CMOS will not be destroyed.**

**Page Left Blank**

---

---

## Appendix A

---

### A-1 MEMORY MAP

---

Address Range	Size	Description
[00000-7FFFF]	512K	Conventional memory
[80000-9FBFF]	127K	Extended Conventional memory
[9FC00-9FFFF]	1K	Extended BIOS data area if PS/2 mouse is installed
[A0000-C7FFF]	160K	Available for Hi DOS memory
[C8000-DFFFF]	96K	Available for Hi DOS memory and adapter ROMs
[E0000-EEFFF]	60K	Available for UMB
[EF000-EFFFF]	4K	Video service routine for Monochrome & CGA adaptor
[F0000-F7FFF]	32K	BIOS CMOS setup utility
[F8000-FCFFF]	20K	BIOS runtime service routine (2)
[FD000-FDFFF]	4K	Plug and Play ESCD data area
[FE000-FFFFF]	8K	BIOS runtime service routine (1)

### A-2 I/O MAP

---

[000-01F]	DMA controller.(Master)
[020-021]	INTERRUPT CONTROLLER.(Master)
[022-023]	CHIPSET control registers. I/O ports.
[040-05F]	TIMER control registers.
[060-06F]	KEYBOARD interface controller.(8042)
[070-07F]	RTC ports & CMOS I/O ports.
[080-09F]	DMA register.
[0A0-0BF]	INTERRUPT controller.(Slave)
[0C0-0DF]	DMA controller.(Slave)
[0F0-0FF]	MATH COPROCESSOR.
[1F0-1F8 ]	HARD DISK controller.
[278-27F]	PARALLEL port 2.
[2B0-2DF]	GRAPHICS adapter controller.

[2F8-2FF]	SERIAL port 2.
[360-36F]	NETWORK ports.
[378-37F]	PARALLEL port 1.
[3B0-3BF]	MONOCHROME & PARALLEL port adapter.
[3C0-3CF]	EGA adapter.
[3D0-3DF]	CGA adapter.
[3F0-3F7]	FLOPPY DISK controller.
[3F8-3FF]	SERIAL port 1.

### **A-3 TIMER & DMA CHANNELS MAP**

#### TIMER MAP:

TIMER Channel 0	System timer interrupt.
TIMER Channel 1	DRAM REFRESH request.
TIMER Channel 2	SPEAKER tone generator.

#### DMA CHANNELS:

DMA Channel 0	Available.
DMA Channel 1	Onboard ECP (Option).
DMA Channel 2	FLOPPY DISK (SMC CHIP).
DMA Channel 3	Onboard ECP (default).
DMA Channel 4	Cascade for DMA controller 1.
DMA Channel 5	Available.
DMA Channel 6	Available.
DMA Channel 7	Available.

### **A-4 INTERRUPT MAP**

#### NMI :

Parity check error.

#### IRQ (H/W):

0	System TIMER interrupt from TIMER 0.
1	KEYBOARD output buffer full.
2	Cascade for IRQ 8-15.
3	SERIAL port 2.
4	SERIAL port 1.
5	PARALLEL port 2.

---

6	FLOPPY DISK (SMC CHIP).
7	PARALLEL port 1.
8	RTC clock.
9	Available.
10	Available.
11	Available.
12	PS/2 Mouse.
13	MATH coprocessor.
14	Onboard HARD DISK (IDE1) channel.
15	Onboard HARD DISK (IDE1) channel.

### **A-5 RTC & CMOS RAM MAP**

RTC & CMOS:

00	Seconds.
01	Second alarm.
02	Minutes.
03	Minutes alarm.
04	Hours.
05	Hours alarm.
06	Day of week.
07	Day of month.
08	Month.
09	Year.
0A	Status register A.
0B	Status register B.
0C	Status register C.
0D	Status register D.
0E	Diagnostic status byte.
0F	Shutdown byte.
10	FLOPPY DISK drive type byte.
11	Reserve.
12	HARD DISK type byte.
13	Reserve.
14	Equipment type.
15	Base memory low byte.

- 16 Base memory high byte.
- 17 Extension memory low byte.
- 18 Extension memory high byte.
- 19-2d
- 2E-2F
- 30 Reserved for extension memory low byte.
- 31 Reserved for extension memory high byte.
- 32 DATE CENTURY byte.
- 33 INFORMATION FLAG.
- 34-3F Reserve.
- 40-7F Reserved for CHIPSET SETTING DATA.



---

**Appendix B**

---

**B-1 POST CODES**

---

ISA POST codes are typically output to I/O port address 80h.

<b>POST (hex)</b>	<b>DESCRIPTION</b>
01-02	Reserved.
C0	Turn off OEM specific cache, shadow.
03	<ol style="list-style-type: none"><li>1. Initialize EISA registers (EISA BIOS only).</li><li>2. Initialize all the standard devices with default values</li></ol> Standard devices includes. <ul style="list-style-type: none"><li>- DMA controller (8237).</li><li>- Programmable Interrupt Controller (8259).</li><li>- Programmable Interval Timer (8254).</li><li>- RTC chip.</li></ul>
04	Reserved
05	<ol style="list-style-type: none"><li>1. Keyboard Controller Self-Test.</li></ol>
06	<ol style="list-style-type: none"><li>2. Enable Keyboard Interface.</li></ol>
07	Reserved.
08	Verifies CMOS's basic R/W functionality.
C1	Auto-detection of onboard DRAM & Cache.
C5	Copy the BIOS from ROM into E0000-FFFFFF shadow RAM so that POST will go faster.
08	Test the first 256K DRAM.
09	OEM specific cache initialization. (if needed)
0A	<ol style="list-style-type: none"><li>1. Initialize the first 32 interrupt vectors with corresponding Interrupt handlers. Initialize INT numbers from 33-120 with Dummy (Spurious) Interrupt Handler.</li><li>2. Issue CPUID instruction to identify CPU type.</li><li>3. Early Power Management initialization. (OEM specific)</li></ol>
0B	<ol style="list-style-type: none"><li>1. Verify the RTC time is valid or not.</li><li>2. Detect bad battery.</li><li>3. Read CMOS data into BIOS stack area.</li><li>4. PnP initializations including. (PnP BIOS only)<ul style="list-style-type: none"><li>- Assign CSN to PnP ISA card.</li></ul></li></ol>

---

	- Create resource map from ESCD.
	5. Assign IO & Memory for PCI devices. (PCI BIOS only)
0C	Initialization of the BIOS Data Area. (40:0N - 40:FF)
0D	1. Program some of the Chipset's value according to Setup. (Early Setup Value Program)
	2. Measure CPU speed for display & decide the system clock speed.
	3. Video initialization including Monochrome, CGA, EGA/ VGA. If no display device found, the speaker will beep.
0E	1. Test video RAM. (If Monochrome display device found)
	2. Show messages including.
	- Award Logo, Copyright string, BIOS Data code & Part No.
	- OEM specific sign on messages.
	- Energy Star Logo. (Green BIOS ONLY)
	- CPU brand, type & speed.
	- Test system BIOS checksum. (Non-Compress Version only)
0F	DMA channel 0 test.
10	DMA channel 1 test.
11	DMA page registers test.
12-13	Reserved.
14	Test 8254 Timer 0 Counter 2.
15	Test 8259 interrupt mask bits for channel 1.
16	Test 8259 interrupt mask bits for channel 2.
17	Reserved.
19	Test 8259 functionality.
1A-1D	Reserved.
1E	If EISA NVM checksum is good, execute EISA initialization. (EISA BIOS only)
1F-29	Reserved.
30	Detect Base Memory & Extended Memory Size.
31	1. Test Base Memory from 256K to 640K.
	2. Test Extended Memory from 1M to the top of memory.
32	1. Display the Award Plug & Play BIOS Extension message. (PnP BIOS only)

---

- 
- |       |  |
|-------|--|
|       | 2. Program all onboard super I/O chips (if any) including COM ports, LPT ports, FDD port ... according to setup value.   |
| 33-3B | Reserved.  |
| 3C    | Set flag to allow users to enter CMOS Setup Utility.   |
| 3D    | 1. Initialize Keyboard.<br>2. Install PS2 mouse.   |
| 3E    | Try to turn on Level 2 cache.<br><b>Note:</b> Some chipset may need to turn on the L2 cache in this stage.<br>But usually, the cache is turn on later in POST 61h.   |
| 3F-40 | Reserved.  |
| BF    | 1. Program the rest of the Chipset's value according to Setup. (Later Setup Value Program)   |
| 41    | 2. If auto-configuration is enabled, program the chipset with pre-defined Values.  |
| 42    | Initialize floppy disk drive controller.   |
| 43    | Initialize Hard drive controller.  |
| 45    | If it is a PnP BIOS, initialize serial & parallel ports.   |
| 44    | Reserved.  |
| 45    | Initialize math coprocessor.   |
| 46-4D | Reserved.  |
| 4E    | If there is any error detected (such as video, kb...), show all error messages on the screen & wait for user to press <F1> key.  |
| 4F    | 1. If password is needed, ask for password.<br>2. Clear the Energy Star Logo. (Green BIOS only)  |
| 50    | Write all CMOS values currently in the BIOS stack area back into the CMOS.   |
| 51    | Reserved.  |
| 52    | 1. Initialize all ISA ROMs.<br>2. Later PCI initializations. (PCI BIOS only) <ul style="list-style-type: none"><li>- assign IRQ to PCI devices.</li><li>- initialize all PCI ROMs.</li></ul> 3. PnP Initializations. (PnP BIOS only) <ul style="list-style-type: none"><li>- assign IO, Memory, IRQ &amp; DMA to PnP ISA devices.</li><li>- initialize all PnP ISA ROMs.</li></ul> 4. Program shadows RAM according to Setup settings. |
-

	5. Program parity according to Setup setting.
	6. Power Management Initialization.
	- Enable/Disable global PM.
	- APM interface initialization.
53	1. If it is NOT a PnP BIOS, initialize serial & parallel ports.
	2. Initialize time value in BIOS data area by translate the RTC time value into a timer tick value.
60	Setup Virus Protection. (Boot Sector Protection) functionality according to Setup setting.
61	1. Try to turn on Level 2 cache.
	Note: If L2 cache is already turned on in POST 3D, this part will be skipped.
	2. Set the boot up speed according to Setup setting.
	3. Last chance for Chipset initialization.
	4. Last chance for Power Management initialization. (Green BIOS only)
	5. Show the system configuration table.
62	1. Setup daylight saving according to Setup value.
	2. Program the NUM Lock, typematic rate & typematic speed according to Setup setting.
63	1. If there is any changes in the hardware configuration, update the ESCD information. (PnP BIOS only)
	2. Clear memory that have been used.
	3. Boot system via INT 19H.
FF	System Booting. This means that the BIOS already pass the control right to the operating system.

## **B-2 Unexpected Errors:**

<b>POST (hex)</b>	<b>DESCRIPTION</b>
B0	If interrupt occurs in protected mode.
B1	Unclaimed NMI occurs.0

**Appendix C**

**NOTE:**

The "LOAD SETUP DEFAULTS" function loads the system default data directly from ROM and initializes the associated hardware properly. This function will be necessary when you accept this mainboard, or the system CMOS data is corrupted.

ROM PCI/ISA BIOS(2A6LFPAB)  
 CMOS SETUP UTILITY  
 AWARD SOFTWARE, INC.

STANDARD CMOS SETUP	SUPERVISOR PASSWORD
BIOS FEATURES SETUP	USER PASSWORD
CHIPSET FEATURES SETUP	IDE HDD AUTO DETECTION
POWER MANAGEMENT SETUP	SAVE & EXIT SETUP
PNP/PCI CONFIGURATION	SAVING
INTEGRATED PERIPHERALS	
LOAD SETUP DEFAULTS	Load SETUP Default (Y/N)? Y
ESC: QUIT	↑ ↓ → ← :SELECT ITEM
F10: Save & Exit Setup	(Shift)F2 :Change Color
Load Setup Defaults Except Standard COMS SETUP	

**LOAD SETUP DEFAULTS**

**Page Left Blank**

---

---

## Appendix D

---

### D-1 GHOST 5.1 Quick User's Guide

---

Installation is very easy. You only need to copy the **Ghost5** folder or **Ghost.exe** to your hard disk.

The current market version is for single **Client**, so the LPT and NetBios portions will not be explained further.

#### Description of Menus

**Ghost** clones and backs up **Disk** and **Partition**.

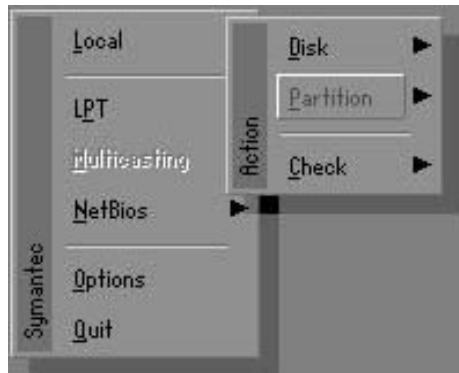

In which **Disk** indicates hard disk options  
**Partition** indicates partition options  
**Check** indicates check options

#### Disk

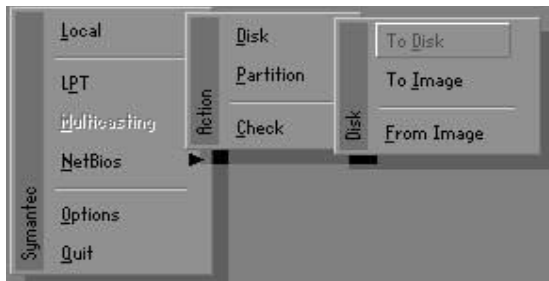

**There are 3 hard disk functions:**

1. Disk To Disk (disk cloning)
2. Disk To Image (disk backup)
3. Disk From Image (restore backup)

**Important!**

1. To use this function, the system must have at least 2 disks. Press the **Tab** key to move the cursor.
2. When restoring to a destination disk, all data in that disk will be completely destroyed.

**Disk To Disk (Disk Cloning)**

1. Select the location of the **Source** drive.
2. Select the location of the **Destination** drive.

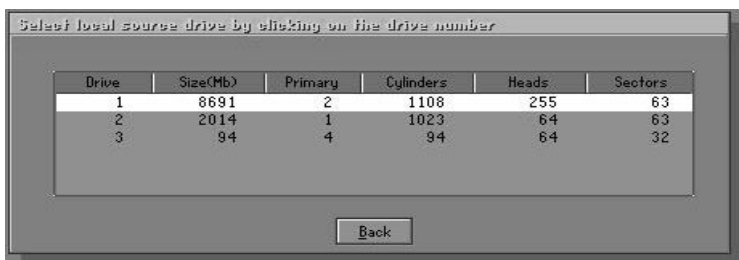

3. When cloning a disk or restoring the backup, set the required partition size as shown in the following figure.

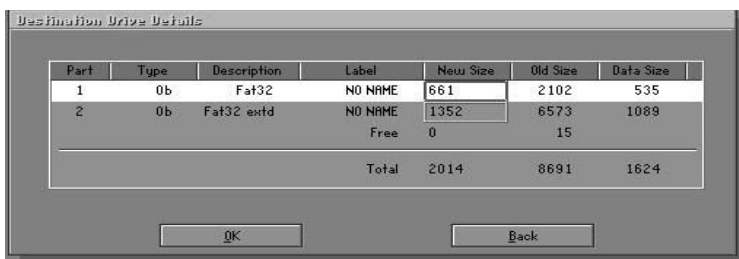



- Click OK to display the following confirmation screen. Select **Yes** to start.

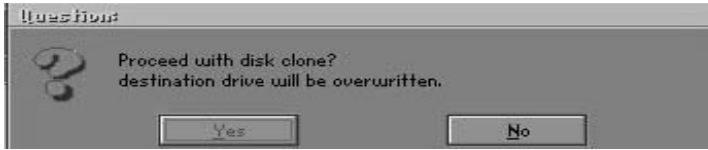

## Disk To Image (Disk Backup)

- Select the location of the Source drive.

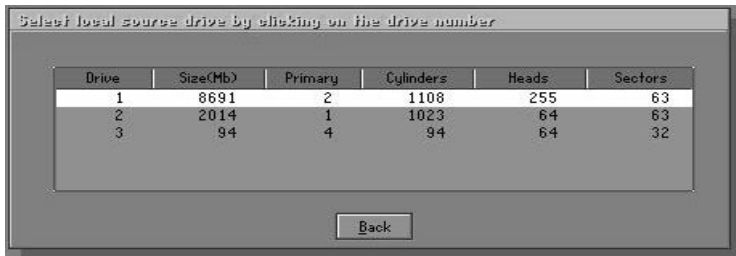

- Select the location for storing the backup file.

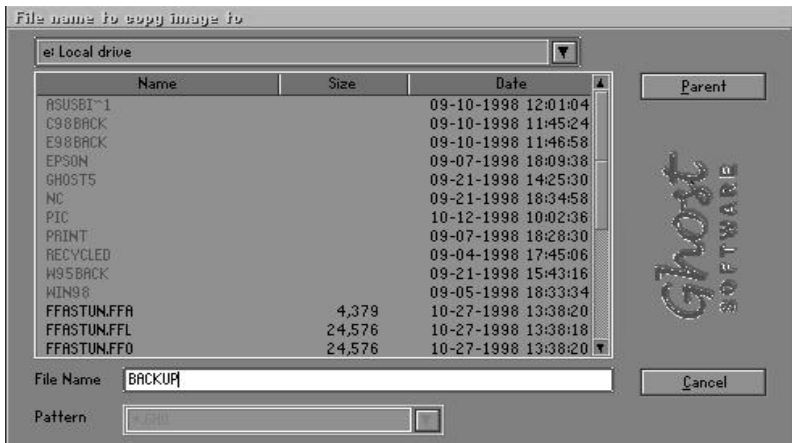

- Click **OK** to display the following confirmation screen. Select **Yes** to start.



## Disk From Image (Restore Backup)

- Select the Restore file.

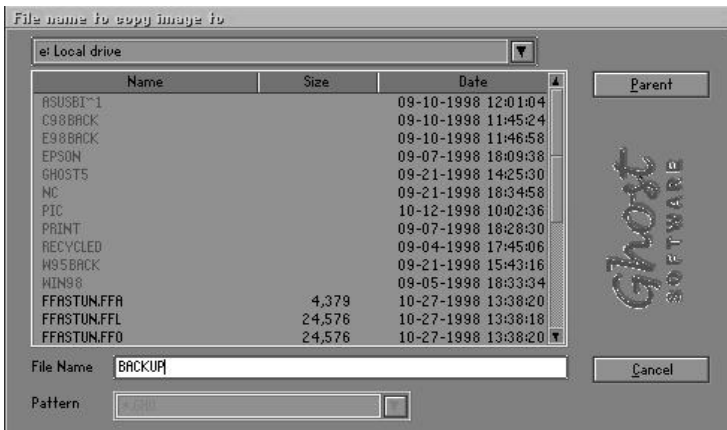

- Select the **Destination drive** of the disk to be restored.

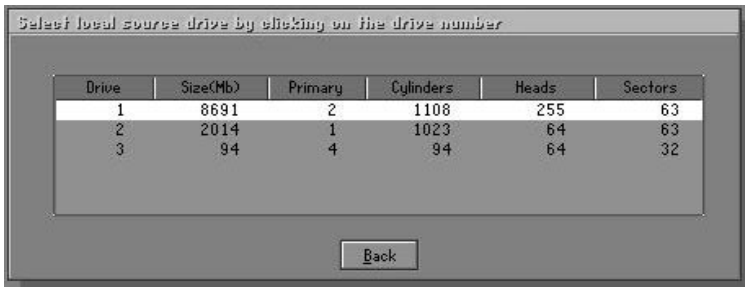

- When restoring disk backup, set the required partition size as shown in the following figure.

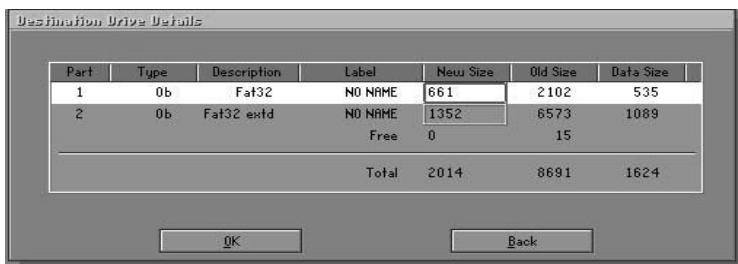

- Click **OK** to display the following confirmation screen. Select **Yes** to start.

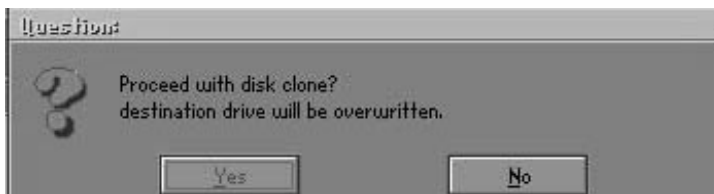

**Partition**

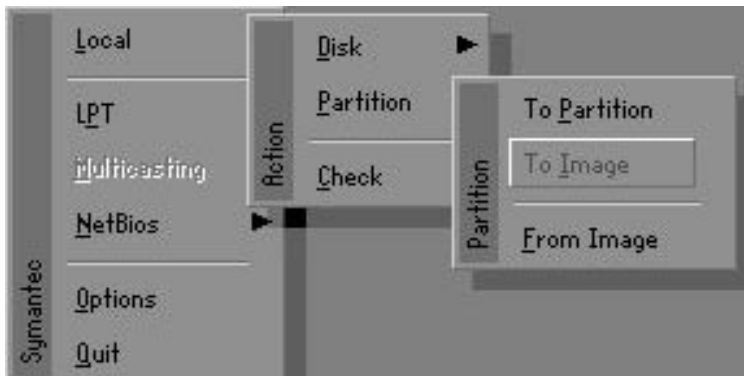

There are 3 partition functions:

1. **Partition To Partition** (partition cloning)
2. **Partition To Image** (partition backup)
3. **Partition From Image** (restore partition)

### Partition To Partition (Partition Cloning)

The basic unit for partition cloning is a partition. Refer to disk cloning for the operation method.

### Partition To Image (Partition Backup)

1. Select the disk to be backed up.

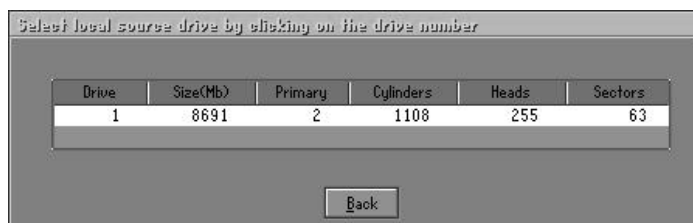

2. Select the first partition to be backed up. This is usually where the operating system and programs are stored.



3. Select the path and file name for storing the backup file.

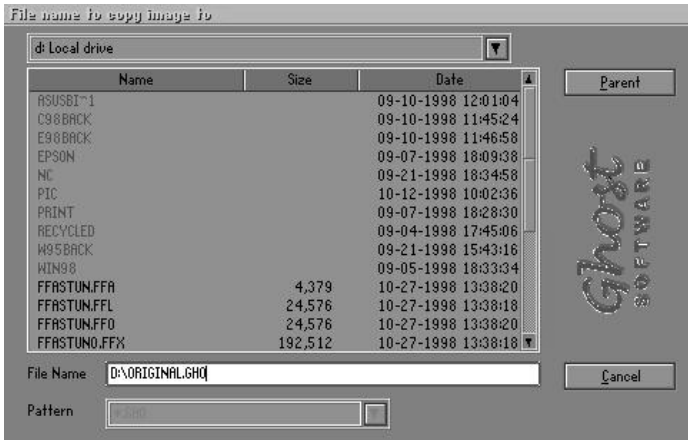

4. Is the file compressed? There are 3 options:

(1) No: do not compress data during backup

(2) Fast: Small volume compression

(3) High: high ratio compression. File can be compressed to its minimum, but this requires longer execution time.

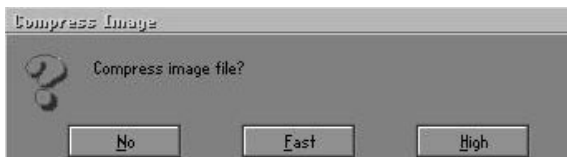

5. During confirmation, select Yes to start performing backup.

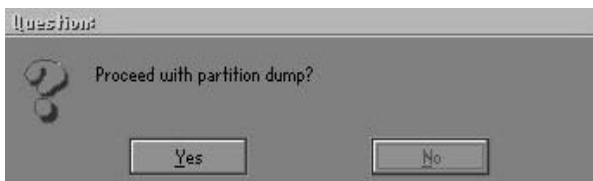

## Partition From Image (Restore Partition)

1. Select the backup file to be restored.

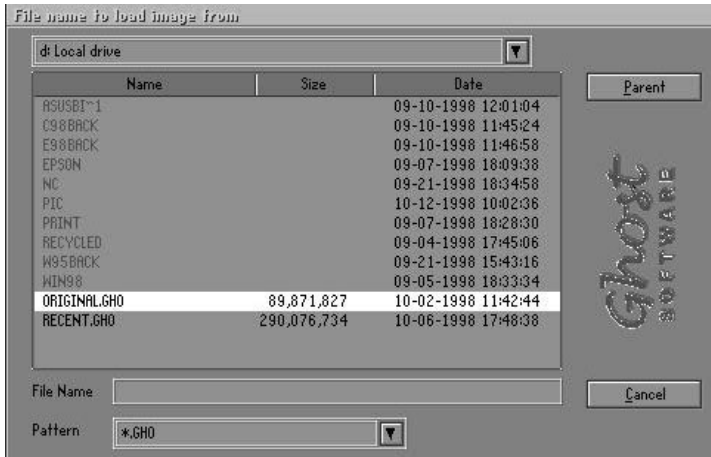

2. Select the source partition.

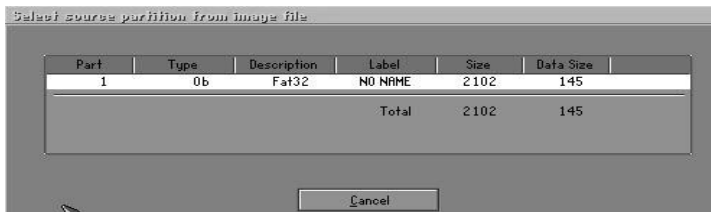

3. Select the disk to be restored.



4. Select the partition to be restored.

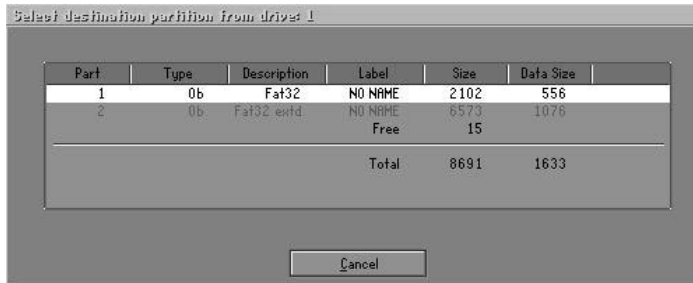

5. Select Yes to start restoring.

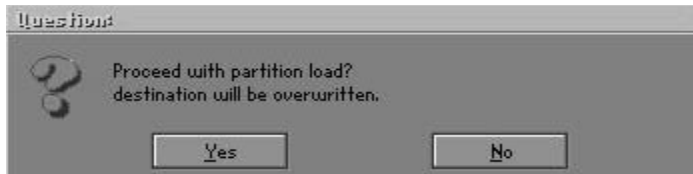

## Check

This function checks the hard disk or backup file for backup or restoration error due to FAT or track error.