

# SILURO GT2 Graphics Accelerator

## Installation Guide and User's Manual

---

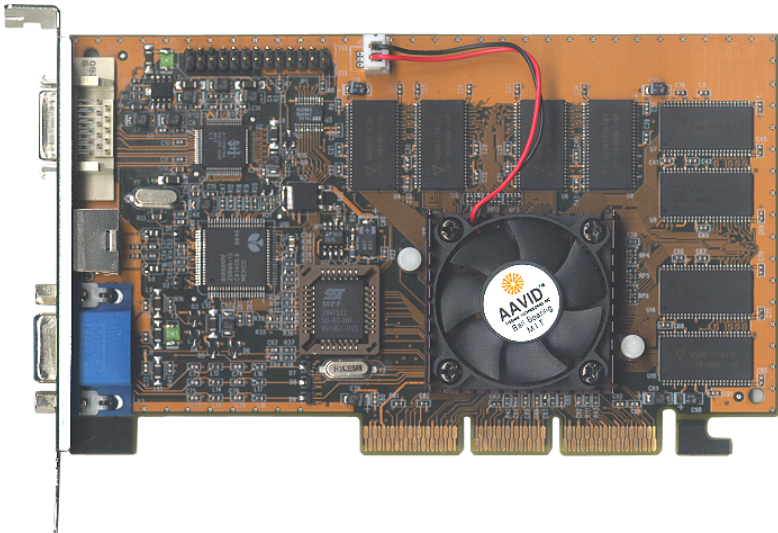

---

---

---

---

## **Copyright and Warranty Notice**

---

---

**The information in this document is subject to change without notice and does not represent a commitment on part of the vendor, who assumes no liability or responsibility for any errors that may appear in this manual.**

**No warranty or representation, either expressed or implied, is made with respect to the quality, accuracy or fitness for any particular part of this document. In no event shall the manufacturer be liable for direct, indirect, special, incidental or consequential damages arising from any defect or error in this manual or product.**

**Product names appearing in this manual are for identification purpose only and trademarks and product names or brand names appearing in this document are property of their respective owners.**

**This document contains materials protected under International Copyright Laws. All rights reserved. No part of this manual may be reproduced, transmitted or transcribed without the expressed written permission of the manufacturer and authors of this manual.**

**If you do not properly set the motherboard settings causing the motherboard to malfunction or fail, we cannot guarantee any responsibility.**

---

---

---

---

---

---

# SILURO GT2 Graphics Accelerator

---

## *Table of Contents*

### *Chapter 1. Getting Started*

- |   |            |
|---|------------|
| <b>1-1. What's in the box? (accessories list)</b> | <b>1-1</b> |
| <b>1-2. Connection Guide</b>                      | <b>1-2</b> |

### *Chapter 2. Introduction of SILURO GT2/SILURO GT2V/SILURO GT2 Ultra*

- |  |            |
|--|------------|
| <b>2-1. Introduction</b>                                 | <b>2-1</b> |
| <b>2-2. Key Features</b>                                 | <b>2-3</b> |
| <b>2-3. Layout Diagram</b>                               | <b>2-4</b> |
| <b>2-4. System Block Diagram</b>                         | <b>2-6</b> |
| <b>2-5. Hardware Installation</b>                        | <b>2-7</b> |
| <b>2-6. TV Output (SILURO GT2V/SILURO GT2 Ultra)</b>     | <b>2-7</b> |
| <b>2-7. Digital Flat Panel Output (SILURO GT2 Ultra)</b> | <b>2-8</b> |

### *Chapter 3. Software Installation*

- |   |             |
|---|-------------|
| <b>3-1. Installing the VGA Driver for Windows® 98 SE</b>                          | <b>3-1</b>  |
| <b>3-2. How to Use the Display Properties Settings in Windows® 98 SE</b>          | <b>3-6</b>  |
| <b>3-3. Display Tray Icon</b>   | <b>3-21</b> |
| <b>3-4. Installing the VGA Drivers for the Windows® NT 4.0 Server/Workstation</b> | <b>3-22</b> |
| <b>3-5. How to Use the Display Properties Settings in Windows® NT</b>             | <b>3-28</b> |
| <b>3-6. Before running Graphic Max</b>  | <b>3-31</b> |
| <b>3-7. Installation of InterVideo WinDVD</b>                                     | <b>3-33</b> |
| <b>3-8. Installing the Microsoft® DirectX 7</b>                                   | <b>3-34</b> |

---

---

<b>3-9. BIOS Flashing Utility</b>	<b>3-35</b>
<b>3-10. How to Update the Current SILURO GT2 Series Products' Drivers &amp; BIOS</b>	<b>3-36</b>
<b><i>Chapter 4. Display Modes Table</i></b>	
Table 4-1. 2D Video Mode Resolution	4-1
Table 4-2. Maximum 3D Mode Resolution	4-2
<b> Technical Support Form</b>	<b>4-3</b>
<b><i>Appendix A How to Get Technical Support</i></b>	

---

---

## Chapter 1. Getting Started

In this chapter we will show you the accessories in this package, what the system needs, and how to install the adapter for your computer. Since the SILURO GT2 Ultra/SILURO GT2V/SILURO GT2 graphics accelerator card has three models, we made this a 3 in 1 manual. The functions of some models will differ from others, and descriptions will be added where these differences occur.

### 1-1. What's in the box? (accessories list)

Read through this section to familiarize yourself with everything that is included with the SILURO GT2 graphics accelerator card.

- One SILURO GT2 Ultra or SILURO GT2V or SILURO GT2 graphics accelerator card (depending on which model you bought)
- One User's manual
- One S-Video extension cable (For SILURO GT2V or SILURO GT2 Ultra only)
- SILURO GT2 installation CD (which includes Windows® 95/98/NT 4.0 drivers, Microsoft® DirectX 7 driver, GART driver, and WinDVD player) and game CD.

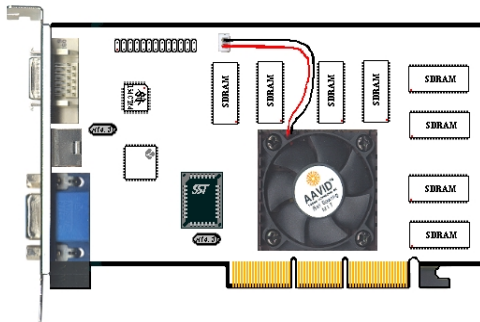

Figure 1-1. SILURO GT2 Ultra graphics accelerator card



Figure 1-2. User's Manual



Figure 1-3. S-Video Cable

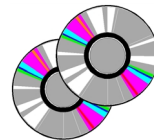
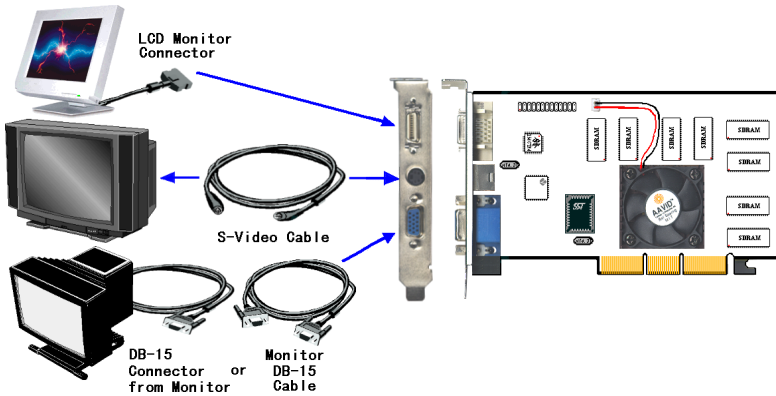

Figure 1-4. Installation CD & Game CD

## 1-2. Connection Guide

This section tells you how to make a quick connection to the SILURO GT2 series graphics accelerator card.

- Step 1.** Insert the SILURO GT2 Ultra (or SILURO GT2V or SILURO GT2) graphics accelerator card into an empty AGP slot on your motherboard, and fix it to the back panel with the screw included.



**Figure 1-5. Connection Diagram of PC Monitor, TV and DFP Monitor**

There are three models for our SILURO GT2 series graphics accelerator cards. The major differences are listed below:

- SILURO GT2 Ultra graphics accelerator card:** RIVA TNT2 Ultra, 32MB SDRAM, DB-15 monitor output, digital flat panel output and TV output connector.
- SILURO GT2V graphics accelerator card:** RIVA TNT2 Pro, 32MB SDRAM, DB-15 monitor output, and TV output connector.
- SILURO GT2 graphics accelerator card:** RIVA TNT2 Pro, 16MB SDRAM, DB-15 monitor output connector.

- Step 2.** Plug the free end of the PC monitor cable into the female DB-15 PC monitor connector on the SILURO GT2 series graphics accelerator card. If you want to use



a TV as your display, connect the S-video cable (included inside the package) to the TV S-video input connector, and connect the other side to the SILURO GT2V or SILURO GT2 Ultra TV output connector.

SILURO GT2 Ultra can be used to make the connection to a digital flat panel monitor.

For more detailed information on the SILURO GT2/SILURO GT2V/SILURO GT2 Ultra, please go to the next chapter.



---

## **Chapter 2. Introduction of SILURO GT2/SILURO GT2V/SILURO GT2 Ultra**

---

Congratulations! You have chosen one of the most powerful high performance 3D graphics accelerator cards available. The SILURO GT2 and SILURO GT2V uses the RIVA TNT2 Pro 128-bit 3D processor chip, the SILURO GT2 Ultra uses the RIVA TNT2 Ultra 128-bit 3D processor chip. This chapter will describe the features, specifications, layout diagram and system diagram.

### **2-1. Introduction**

---

The SILURO GT2 series 2D/3D graphics accelerator card provides you powerful 3D acceleration, and also provides the most advanced Direct3D/OpenGL acceleration solution for games, professional 2D/3D CAD/CAM applications and 3D drawing applications. The SILURO GT2 series 2D/3D graphics accelerator card offers industry leading 2D/3D performance, meeting all the requirements of the mainstream PC graphics market and Microsoft's PC98 and DX6 initiatives. It supports significant advances in Direct3D™ and OpenGL™ acceleration, and 2D and video performance, enabling a wide range of applications from 3D games through DVD, InterCast™ and video conferencing. A complete high performance OpenGL ICD is included in the standard software driver package.

Moving into the 21<sup>ST</sup> century, digital flat panel displays (FPD) will be ubiquitous, linked to everyday electronic appliances from desktop computers to DVD players to set-top boxes. By the turn of this century, we'll either own a digital FPD monitor, or know someone that does. Inevitably, as prices drop far enough, large screen, all-digital TVs will be the display of choice to maximize the all-digital video viewing experience. But to make all this happen, the consumer electronics and PC industry must adopt a digital interface standard to link digital video/graphics sources to digital FPD. When the video is kept digital from source-to-FPD, the system is "all-digital".

For this all-digital trend, the SILURO GT2 Ultra graphics accelerator card can be equipped with the SiI 154 chipset (Optional). The SiI 154 uses PanelLink® Digital technology to support displays ranging from VGA (25MHz, 640\*480) to SXGA (112MHz, 1280\*1024) which are ideal for desktop and specialty applications. It supports VESA® P&D™ and DFP (Digital Flat Panel) Hot Plug Detection plus the RxDetect feature. The SiI 154 operates with all PanelLink® receivers and leads the way in promoting the digital display interface as a standard feature in all PCs by enabling all multimedia accelerators with a flexible 12 or 24-bit interface in a cost-effective package. Featuring a 12-bit dual-edge clock interface that supports resolutions up to SXGA, the SiI 154 is designed to work with feature-rich, high-

end multimedia accelerators that typically don't have enough pins available to support a 24-bit interface.

It's the fully digital interface design driving the Flat Panel Display (FPD) that gives you better display quality than analog interface does. Figure 2-1 below shows the differences between digital and analog interface display quality. You can see why we chose this chipset.

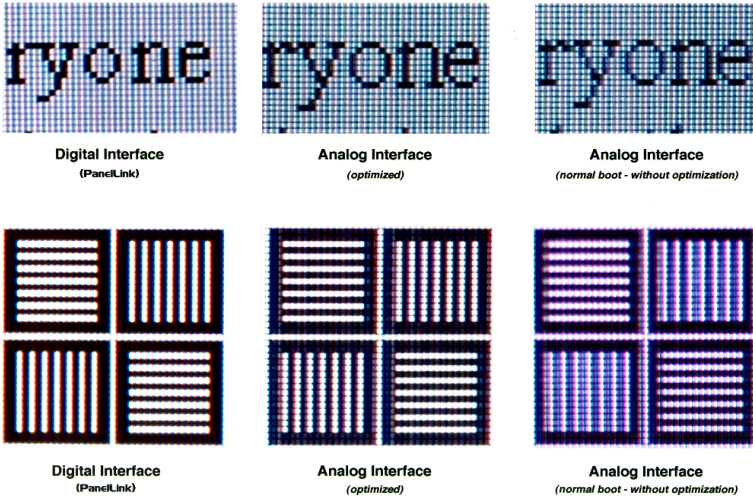

Figure 2-1. Digital and analog interface display quality comparison

---

## 2-2. Key Features

---

- Optimized for Direct3D acceleration with complete support for DirectX 5.0 and 6.0
- 24-bit Z-buffer, 8-bit stencil buffer
- High performance 128-bit 2D/GUI/DirectDraw acceleration
- 128-bit wide frame buffer interface supporting up to 32 Mbyte SDRAM
- Fast 32-bit VGA/SVGA
- Anisotropic filtering (better than Tri-Linear MIP-mapping)
- Twin texel 32-bit graphics pipeline
- 32-bit RGB rendering with destination alpha
- Video acceleration for DirectShow™, MPEG-1/2 and Indeo®
- 100% hardware triangle setup engine
- 300MHz Palette-DAC supporting up to 2048\*1536, Hi Color 60Hz
- AGP 4x/2x/1x with full sideband/execute mode support
- S-Video output for NTSC and PAL TV-output (SILURO GT2V and SILURO GT2 Ultra)
- DDWG (Digital Display Working Group) compliant DFP (Digital Flat Panel) output up to 1280\*1024 (SILURO GT2 Ultra only)

\* The standard 128-bit 3D processor core speed for SILURO GT2 Ultra is 150MHz, and for the SILURO GT2/SILURO GT2V the speeds are 125MHz. The standard SDRAM speed for the SILURO GT2 Ultra is 183MHz, and for the SILURO GT2/SILURO GT2V it is 166MHz. Above standard operation speed is supported but not guaranteed due to the chipset and SDRAM specifications.

\* Specifications and information contained in this manual are subject to change without notice

<b>Note</b>
-------------

All brand names and trademarks are the property of their respective owners.
---

### 2-3. Layout Diagram

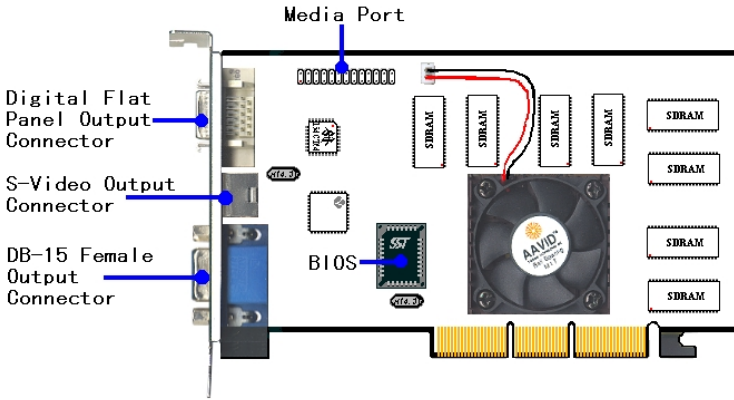

Figure 2-2. SILURO GT2 Ultra Layout Diagram.

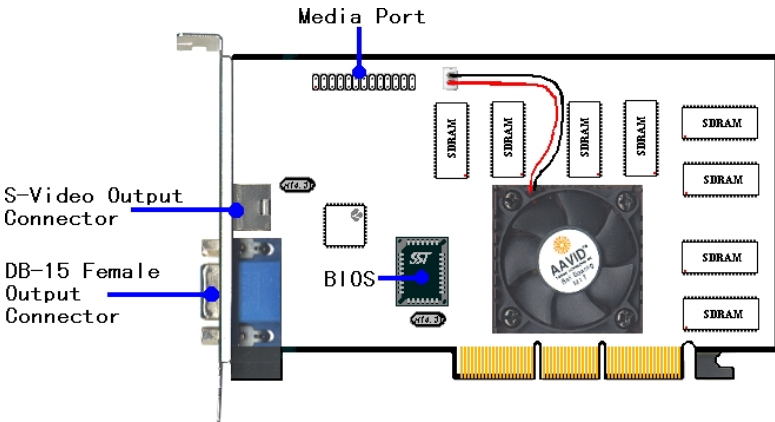

Figure 2-3. SILURO GT2V Layout Diagram

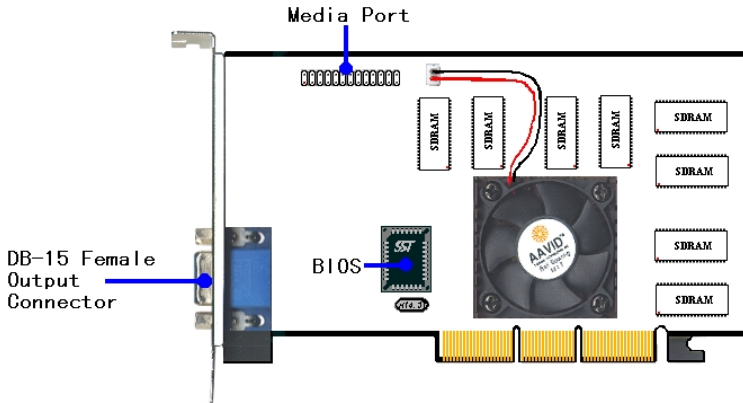

Figure 2-4. SILURO GT2 Layout Diagram

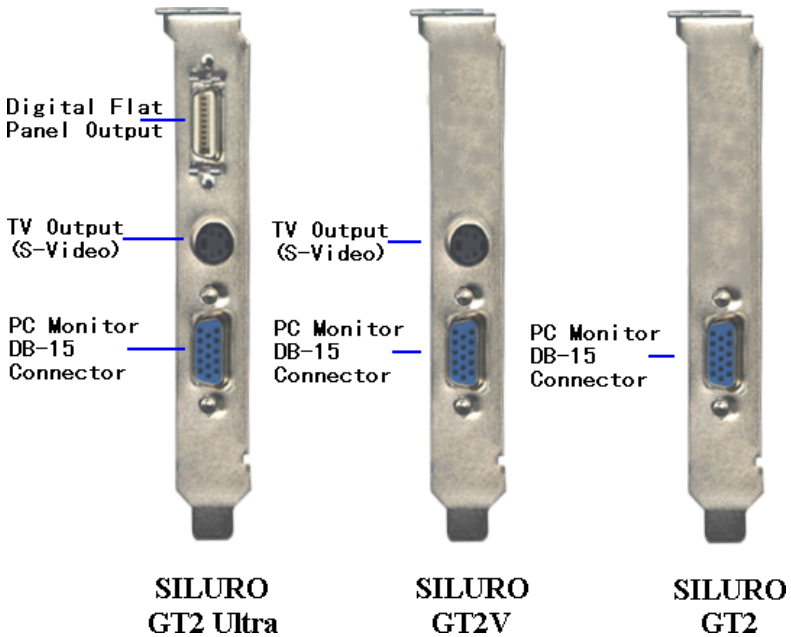

Figure 2-5. SILURO GT2 Series 2D/3D graphics accelerator card Back Plate layout

## 2-4. System Block Diagram

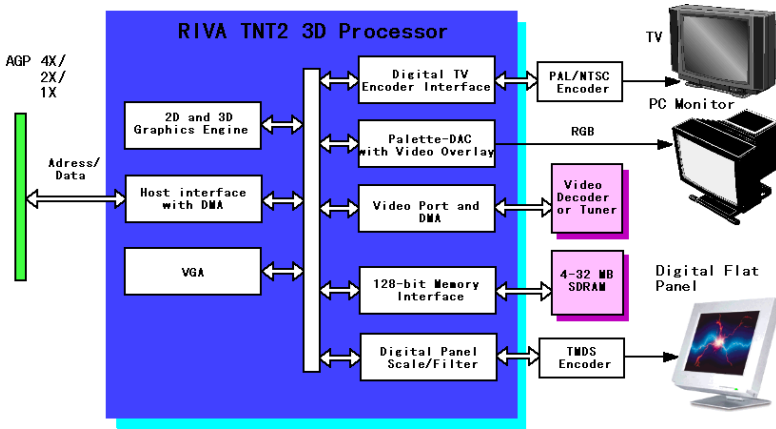

Figure 2-6. SILURO GT2 Series Display Card System Block Diagram



## 2-5. Hardware Installation

You can identify which SILURO GT2 series 2D/3D graphics accelerator card you bought using **Figures 2-2 through 2-4**. You can then check **Chapter 1, Section 1-2** on how to connect your PC monitor, TV or DFP (**D**igital **F**lat **P**anel) to the back panel of the display card.

If you bought the SILURO GT2V 2D/3D graphics accelerator card and you want to display the image on a TV, you have to go into Display Properties to set up it. It can't display the image using both the TV output and PC monitor DB-15 output connectors.

If you bought the SILURO GT2 Ultra, then you can display the image using the PC monitor DB-15 output or the DFP output connectors. For the TV output, you still need go into Display Properties to set up it. (same as SILURO GT2V)

## 2-6. TV Output (SILURO GT2V/SILURO GT2 Ultra)

Please go to the “**Display Properties**” → “**Output Device**” folder to set the display mode for TV output.

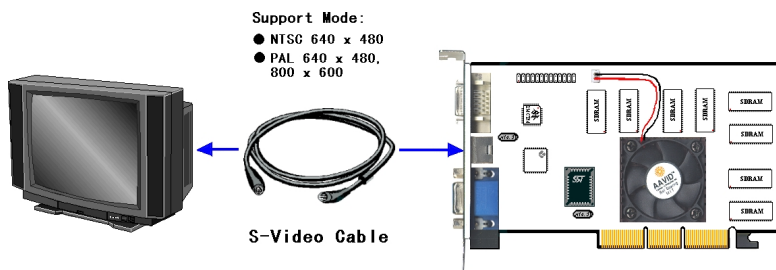

Figure 2-7. SILURO GT2V/SILURO GT2 Ultra connection to TV

## 2.7. Digital Flat Panel Output (SILURO GT2 Ultra)

A digital flat panel display can be connected to the DFP output on the GT2 Ultra display card, but the display card BIOS will choose analog display as the output device. To choose DFP display as the output device, go to the “**Display Properties**” → “**Output Device**” folder and change the setting to “**Digital Flat Panel**”. Images cannot be displayed on both analog monitor and DFP display simultaneously.

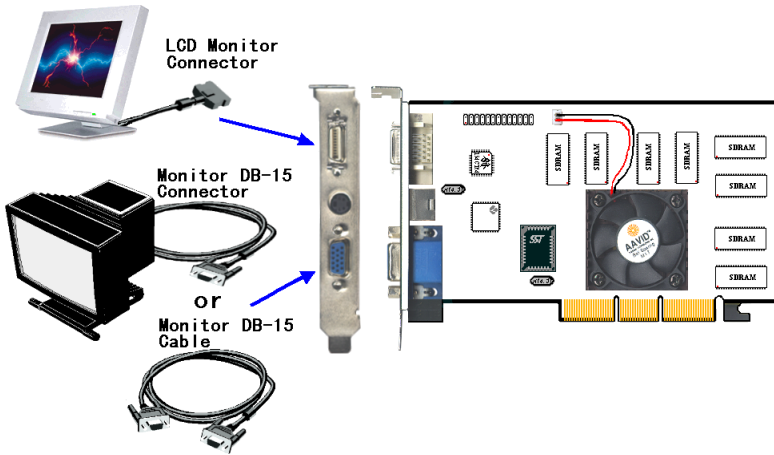

Figure 2-8. SILURO GT2 Ultra connecting to Digital Flat Panel Display

With the DFP display connection, the SILURO GT2 Ultra supports the following modes:

- 640 x 480, 8/16/32 BPP
- 800 x 600, 8/16/32 BPP
- 1024 x 768, 8/ 16/32 BPP
- 1280 x 1024, 8/16/32 BPP

---

## Chapter 3. Software Installation

---

This chapter will show you how to install the software and drivers for the SILURO GT2 series 2D/3D graphics accelerator card. The SILURO GT2 series products package contains the *Installation CD*. Use this CD to install all drivers and software needed.

### 3-1. Installing the VGA Driver for Windows® 98 SE

---

This section will tell you how to install the SILURO GT2 series 2D/3D graphics accelerator card driver for in Windows® 98 SE. There are two situations when you would install this driver. One is when you are assembling a new computer system and are installing a new operating system. The other is when you replace your VGA card with a SILURO GT2 series 2D/3D graphics accelerator card with the operating system already installed.

In the first situation, please set the Windows VGA driver to “Standard PCI Graphics Adapter (VGA)” driver to install the Windows® 95/98. After the Windows® 95/98 installation is complete, then go to Step 1 for installing the SILURO GT2 series 2D/3D graphics accelerator card driver.

In second situation, before you install the SILURO GT2 series 2D/3D graphics accelerator card into your computer system, please go to the *Display Properties* and change your VGA driver to “Standard PCI Graphics Adapter (VGA)” driver. Leave *Display Properties*, then you can close Windows and install the SILURO GT2 series 2D/3D graphics accelerator card into your computer system. After you install it, go to Step 1 to install the SILURO GT2 series 2D/3D graphics accelerator card driver.

The following section shows you how to install the VGA drive to your Windows® 98 SE operating system.

#### Note 3-1-1

After changing the VGA driver to “Standard PCI Graphics Adapter (VGA)” driver, the quality of your display will be poor because it will be set to 640\*480 and 16 color. For the best screen capture quality, install the VGA drivers and set the desktop to 800\*600 using True Color.

**Note 3-1-2**

Details of the Windows® 98 SE operating system will not be mentioned in this manual. If you have any problems with Windows® 98 SE installation, operations and settings, please refer to your Windows® 98 SE user's manual or other databases provided by Microsoft® Corporation.

The installing procedure of Windows® 95, 95 OSR2 and 98 are very similar to Windows® 98 SE, but there may be slight differences between them. If you follow the instructions shown within installation procedure, the drivers' installation should be very easy.

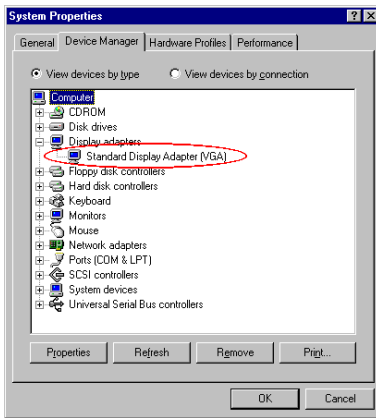

First, go to check the “System Properties” → “Device Manager” → “Display Adapters”. Your system now shows the “Standard PCI Graphics Adapter [VGA]”.

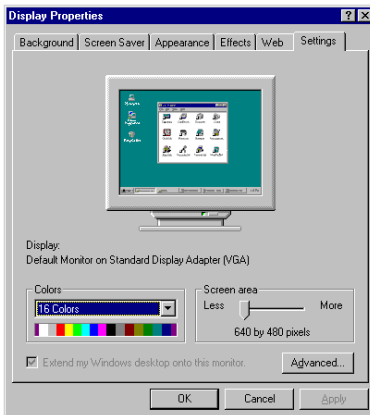

Also check your Display Properties, as in the figure to the left. If you want to change your old VGA adapter to a Siluro display adapter, you must set the display type to “Standard PCI Graphics Adapter [VGA]” first, then reboot the computer for it to take effect. Otherwise, you may not be able to install the new display drivers in the next step.

Exit the device manager and insert the *ABIT Siluro Installation Disc* into the CD-ROM drive. It should execute the program automatically. If not, you can go to the CD location and execute the execution file at the root directory of this CD-Title. After it has been executed, you will see the screen below. Move the cursor to the "Drivers" and click on it. This will take you to the next screen.



Click "Display Drivers" icon and go to next.



Click the "Display Driver for Windows 9X" icon then continue.



Click "Install Display Driver" icon. The program will automatically install the necessary driver for the Siluro display adapter.

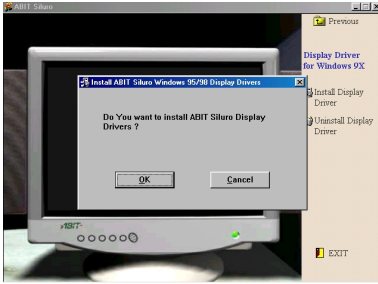

The dialogue box will appear to ask you really want to install Siluro drivers. Click the “**OK**” button. The program will start installing the drivers and the screen show that the files are being copied.

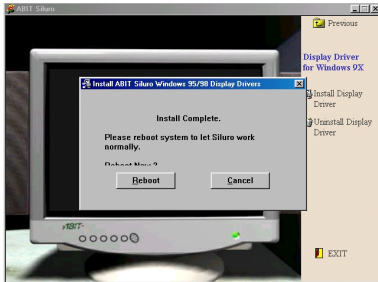

When the installation is complete, a dialogue box will appear and ask you to reboot your computer. Click the “**Reboot**” button to reboot your computer.

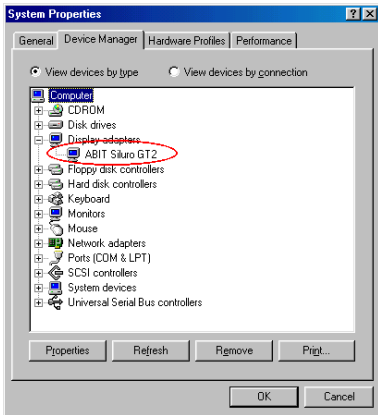

Go to “**System Properties**” → “**Device Manager**” → “**Display Adapters**”. Your system will now show the “**ABIT Siluro GT2**”.

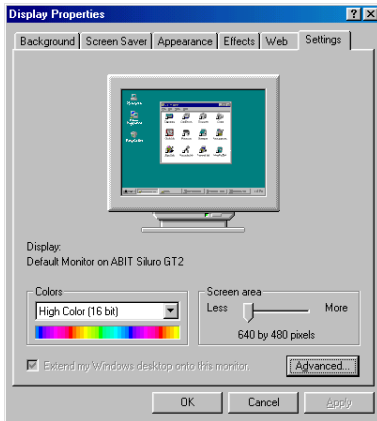

Also check your Display Properties, as in the figure to the left.

This means that you have successfully installed the drivers.

## 3-2. How to Use the Display Properties Settings in Windows® 98 SE

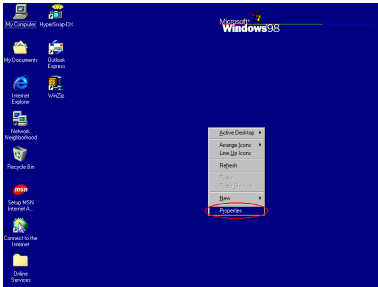

**Step 1.** When you have properly installed the drivers for the Windows® 98 SE operating system, right-click on the Windows® 95/98 desktop wallpaper area and select the item “**Properties**”.

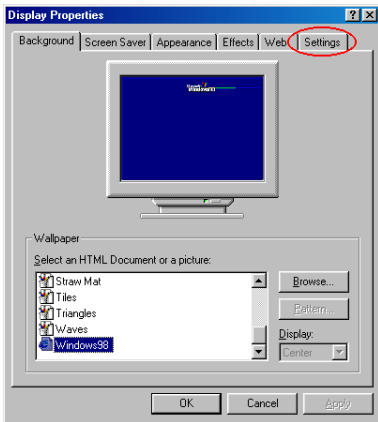

**Step 2.** The “**Display Properties**” item will appear on your screen and select the “**Settings**” folder.

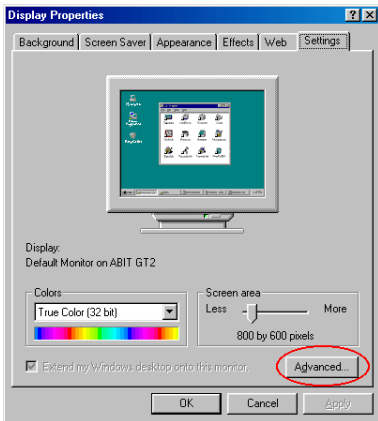

**Step 3.** Click the “**Advanced...**” button and go to the next step.



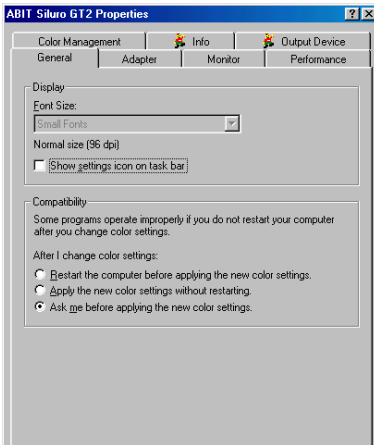

**Step 4.** Now you can see all the further functions of this display card. Detailed information about these settings follows.

You should see the “**General**” folder initially. Click on the right-side arrow at the item “**Font Size**” and choose the font size you want.

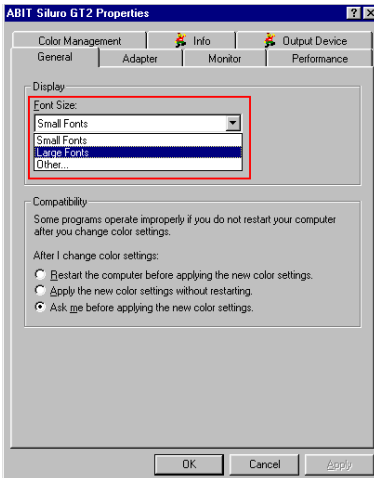

**Step 5.** You can choose the font size here. If you choose “**Other...**” the next screen will appear.

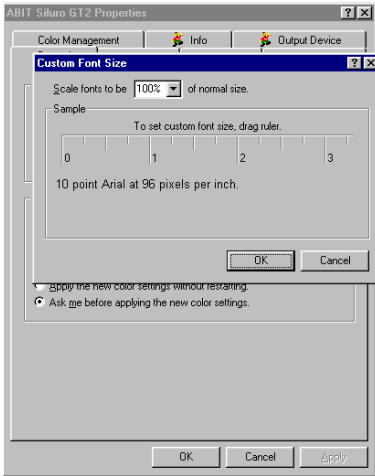

**Step 6.** You can make further font size adjustments here, as this screen demonstrates.

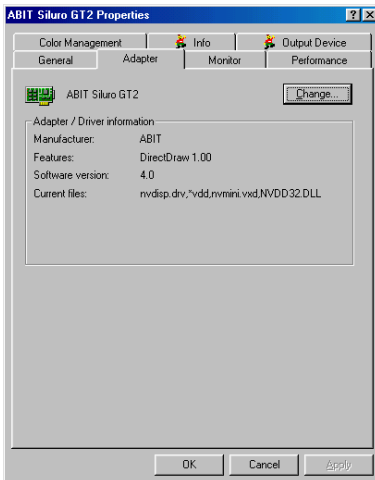

**Step 7.** Now if you go to the “**Adapter**” folder, you will see the current display driver information. You can change the driver here. If you click the “**Change...**” button, you will see the next screen shot.

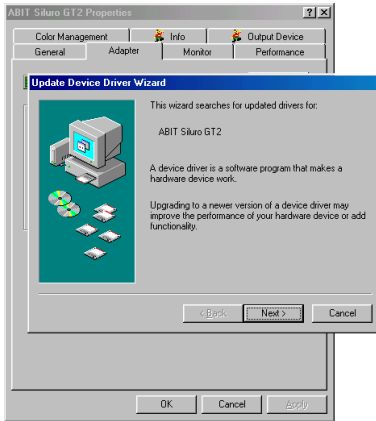

**Step 8.** Follow the instructions to install the new display driver.

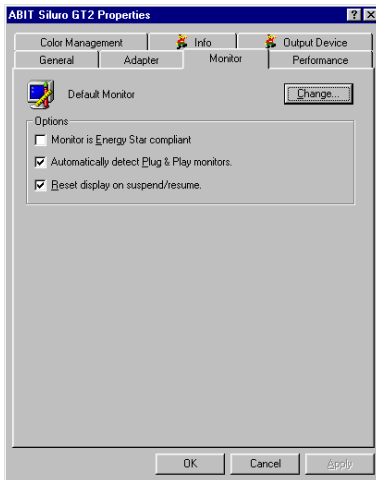

**Step 9.** Now check the “**Monitor**” folder content. It can let you check your monitor model and settings. You can change the monitor type by click the “**Change...**” button.

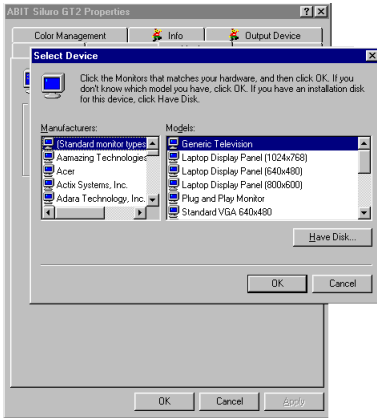

**Step 10.** You can select the manufacturer on left side window and the model on the right side window, or whether you want to install a driver from disk. You can click the “**Have Disk...**” button to install a new driver from the disk drive.

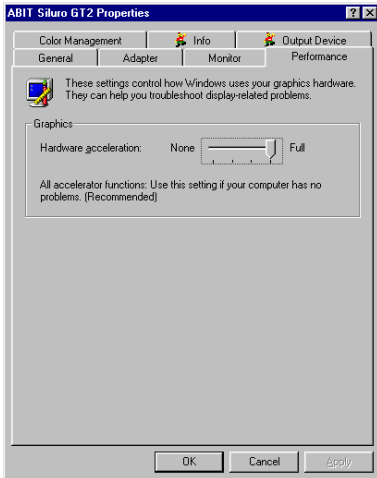

**Step 11.** The “**Performance**” folder will show how Windows uses your display adapter. It can help you troubleshoot display-related problems.

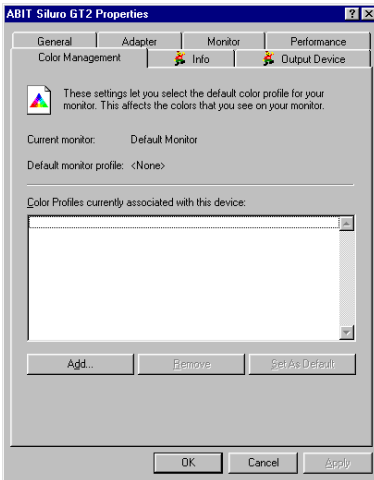

**Step 12.** When you check the “**Color Management**” folder, you will see there are seven folders inside this folder.

You should be in the “**Color Management**” folder initially. These settings let you select the default color profile for your monitor. This will affect the colors that you see on your monitor.

High-end or some middle-end monitors will provide a color profile file with the monitor. It will allow your colors to be shown more accurately on the screen. If you do have such a profile disk, please click the “**Add...**” button.

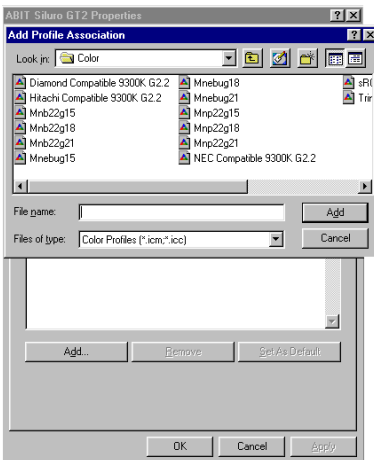

**Step 13.** You will see several profiles in the window. If your monitor type is listed here, select it directly. Otherwise, put the disk into the drive and click the “**Add**” button to install it.

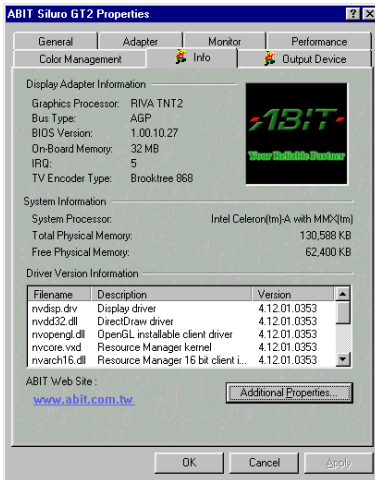

**Step 14.** The folder “**Info**” will show you all the detailed information regarding your graphics card.

If you want more settings for your graphics card, please click the “**Additional Properties...**” button to go to the next screen.

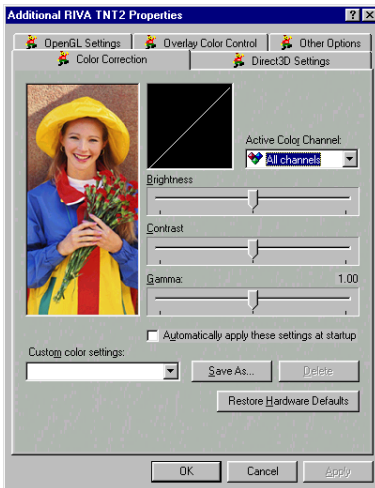

**Step 15.** There are four more item folders that can be selected. First, look the folder called “**Color Correction**”,

This item lets you adjust brightness, contrast, and gamma parameters.

The most important parameter is the gamma adjust. If you don’t know what gamma means, you may want to examine additional information explaining color before you make any adjustments.

The gamma adjust lets you adjust each channel’s value. Which means that you can adjust the red, blue, or green channel gamma value separately.

The adjustment in “**Color Correction**” will affect the way colors appear on your monitor, and will affect color accuracy. When you change the settings, the photo in the left window will change the color and you can see how each change you made looks.



**Step 16.** Exit the “Color Correction” folder and select the “Direct3D Settings” folder.

First check the “Performance and Compatibility Options” items:

■ **Enable fog table emulation:**

This option is used to turn the fog table emulation on or off.

Direct3D specifies that a display adapter capable of D3D hardware acceleration should be able to implement either vertex fog or table fog. Some games do not correctly query the D3D hardware capabilities and expect table fog support.

Choosing this option will ensure that such games will run properly on your Nvidia graphics processor.

■ **Adjust Z-buffer depth to rendering depth if unequal:**

This will cause the hardware to automatically adjust the depth of its Z-buffer to the depth that the application requests.

Normally, you will want to keep this option enabled, unless your work absolutely requires a specific Z-buffer depth. If this option is disabled, any application whose working Z-buffer depth does not match that of the current hardware configuration will not run.

■ **Enable alternate depth buffering technique:**

This enables an alternate technique for depth buffering.

This allows the hardware to use a different mechanism for depth buffering in 16 bit applications. Enabling this setting can produce higher quality rendering of 3D images.

■ **Display logo when running Direct3D applications:**

This enables the Nvidia logo in Direct3D.

Enabling this setting will display the Nvidia logo in the lower corner of the screen while running Direct3D applications.

Now check the “**Mipmapping**” items:

■ **Automatically generate:**

The RIVA TNT II can automatically generate mipmaps to increase the efficiency of texture transfers across the bus and provide higher performance of Direct3D accelerated applications and games.

For some applications, the automatic generated mipmaps will cause problems. In such cases, you can reduce the number of automatically generated mipmap levels until the images are properly displayed. Usually, decreasing the number of mipmap levels can eliminate texture misalignment or seaming. (If you do that, some performance will be lost.)

■ **Auto-mipmap method:**

This option has two options: bilinear and trilinear. The bilinear method provides better performance than the trilinear method. The trilinear method provides higher image quality than bilinear method.

■ **Mipmap detail level:**

This option allows you to adjust the level of detail (LOD) bias for mipmap. A lower bias will provide better image quality, and higher bias will increase application performance. You can choose from five preset bias values from “Best Image Quality” to “Best Performance”.

**Step 17. More Direct3D Settings:**

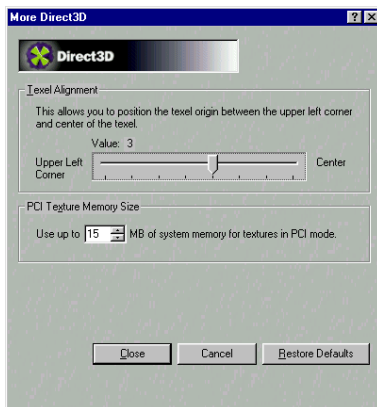

If you click the “**More Direct3D...**” button, you will see the following items:

■ **Texel Alignment:**

This option changes the hardware texture addressing scheme for texels (texture elements). If changing these values will adjust the texel origin definition. The default setting value is in accordance with Direct3D specifications. Some software will define the texture origin to other places. For such applications, re-defining the texture origin will improve the image quality. You can use

the slider to adjust the texel origin anywhere between the upper left to the center of the texel.



## ■ PCI Texture Memory Size:

This option allows the graphics processor to utilize up to the specified amount of system memory for texture storage (in addition to the memory installed on the display adapter itself).

### Note 3-2-1

The maximum amount of system memory that can be reserved for texture storage is based on the amount of physical RAM installed in your computer. The more system RAM, the higher the value you will be able to set.

A larger value can improve the performance for some Direct3D applications. This setting applies only to PCI display adapters. If you use the AGP bus display adapter, this option will not be available (except when the AGP display adapters are running in PCI compatibility mode).

**Step 18.** The “**OpenGL Settings**” folder allows you to adjust the image texture quality in OpenGL applications.

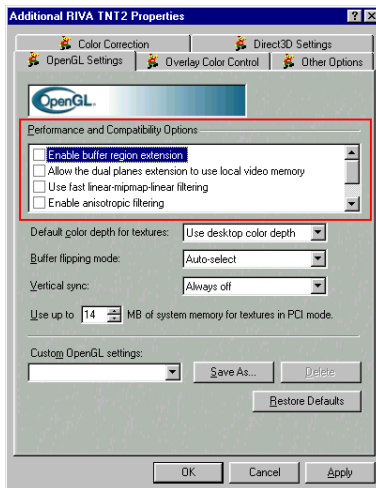

The following are “**Performance and Compatibility Options**” items:

### ■ **Enabled buffer region extension:**

This option allows the drivers to use the OpenGL extension **GL\_KTX\_buffer\_region**.

This can increase application performance in 3D modeling applications that support this extension.

### ■ **Allow the dual planes extension to use local memory:**

Allows the use of local video memory when the **GL\_KTX\_buffer\_region** extension is enabled.

However, if there are less than 8MB of local video memory available, dual planes extension support will not be enabled. This setting has no effect if the “**Enable buffer region extension**” option above is disabled.

### ■ Use fast linear-mipmap-linear filtering:

Allowing fast linear-mipmap-linear filtering will provide increased application performance at the expense of some image quality.

In many cases, a loss of image quality may not be noticeable, so you may wish to take advantage of the extra performance gained by enabling this feature.

### ■ Enable anisotropic filtering:

This option allows OpenGL to use anisotropic filtering for improved image quality.

### ■ Enable alternate depth buffering technique:

Enables an alternate technique for depth buffering. This lets the hardware use a different mechanism for depth buffering in 16 bit applications. Enabling this setting can produce higher quality rendering of 3D images.

### ■ Disable support for enhanced CPU instruction sets:

Select this option to disable driver support for enhanced instructions used by certain CPUs. Some processors that support additional 3D instructions can improve performance in 3D games or applications, for example, the Intel® MMX™ series and AMD 3D NOW!™ series processors. If these 3D games and applications are not optimized for these enhanced instruction processors this will have no effect. The display drivers also need to support these features. You can disable this option and it may be useful for troubleshooting and performance comparison.

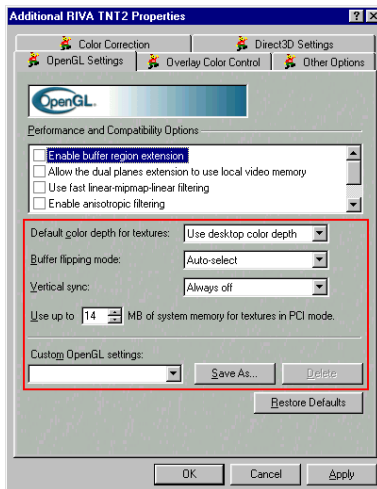

**Step 19.** Also note the following items:

■ **Default color depth for textures:** This option determines whether textures of a specific color depth should be used by default in OpenGL applications.

#### ● Use desktop color depth:

This setting will always use the texture of the color depth at which your Windows desktop is currently running.

#### ● Always use 16 bpp or Always use 32 bpp:

These options will force the use of textures of the specified color depth, regardless of your desktop settings.

---

---

**■ Buffer flipping mode:**

This option determines the buffer flipping mode for full-screen OpenGL applications. You can select from the block transfer method, the page flip method or auto-select. Auto-select allows the driver to determine the best method based on your hardware configuration.

**■ Vertical sync:**

This option lets you specify how vertical sync is handled in OpenGL.

- **Always off:** This setting will always disable vertical sync in OpenGL applications.
- **Off by default:** This setting will keep vertical sync disabled, unless an application specifically requests that it be enabled.
- **On by default:** This setting will keep vertical sync enabled, unless an application specifically requests that it be disabled.

**■ Use up to “XX” MB of system memory for textures in PCI mode:**

This allows the graphics processor to utilize up to the specified amount of system memory for texture storage (in addition to the memory installed on the display adapter itself).

<b>Note 3-2-2</b>
-------------------

The maximum amount of system memory that can be reserved for texture storage is based on the amount of physical RAM installed in your computer. The more system RAM, the higher the value you will be able to set.
--

A larger value can improve the performance for some Direct3D applications. This setting applies only to PCI display adapters. If you use the AGP bus display adapter, this option will not be available (except when the AGP display adapters are running in PCI compatibility mode).

**■ Custom OpenGL settings:**

A list of the custom settings (or “tweaks”) you have saved. Selecting an item from the list will activate the setting. To apply the setting, choose the “**OK**” or “**Apply**” button.

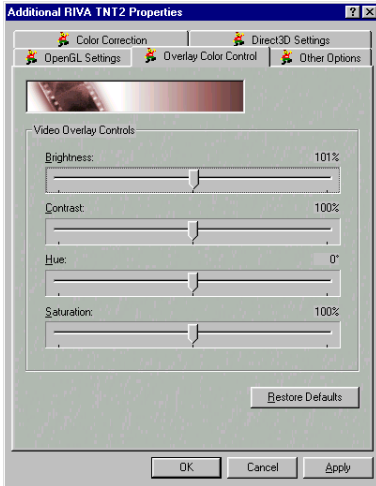

### Step 20. “Overlay Color Control” folder:

Uses these controls to adjust the quality of video or DVD playback on your monitor.

You can independently control the brightness, contrast, hue and saturation to achieve optimal image quality when playing back video or DVD movies on your computer.

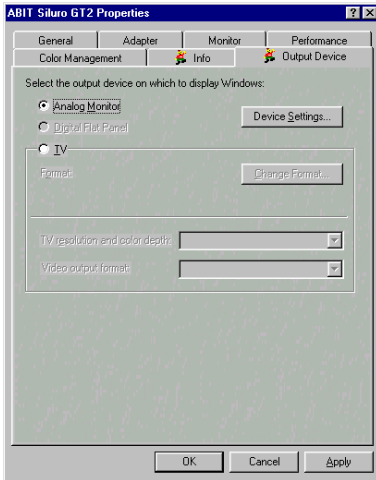

### Step 21. “Output Device” folder:

First, look at “**Analog Monitor**” & “**Digital Flat Panel**”.

Here you can select what kind of output device you are using. Most people use the “**Analog Monitor**” setting. If you have a DFP display, you can select “**Digital Flat Panel**” as the output device here.

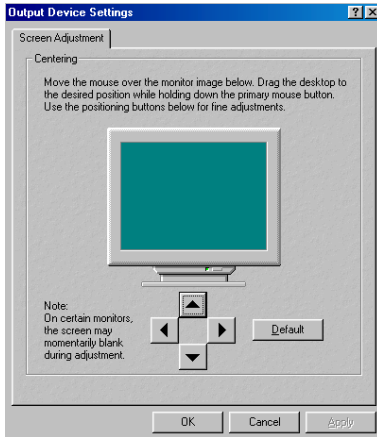

**Step 22.** After you choose the output device, you can click the “**Device Settings...**” button to adjust the centering of the screen display.

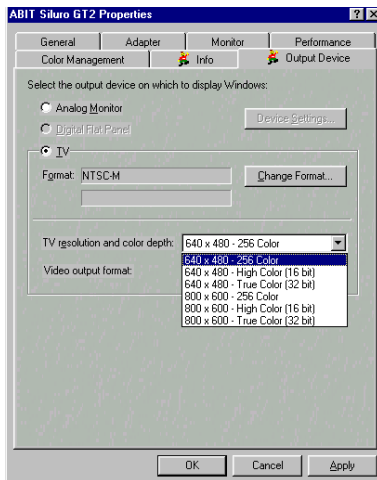

**Step 23.** If you want to use a TV as your image display, select the “**TV**” check box. You can choose the TV resolution and color depth: three options are available from 640 x 480 – 256 Color to 800 x 600 – True Color (32 bit).

When you select one, the following screen will appear.

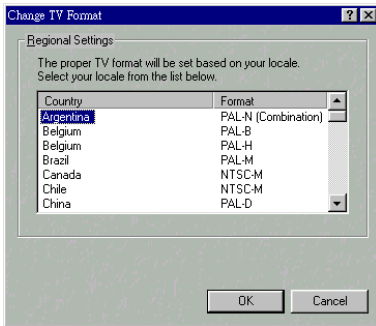

Step 24. If you choose the item “Video output format”, you will see this screen. Please select your local TV system video format from this item. If you choose the wrong system, the displayed images may be missing or distorted.

**Step 25.** This screen informs you that it will switch your desktop to the selected settings. Click the “OK” button.

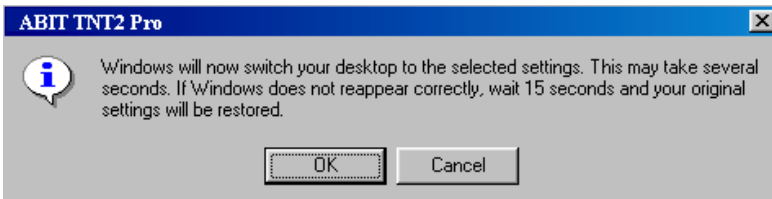

**Step 26.** The screen will ask if you want to keep this setting or not. If there are no problems with the display image, click the “Yes” button to keep this setting.

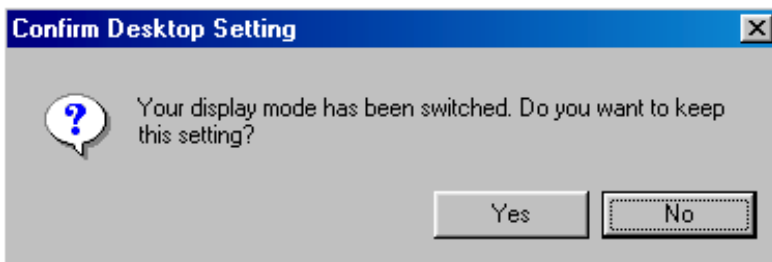

### 3-3. Display Tray Icon

After you install the VGA drivers, you can see the “Soft Jumpy” icon on right corner of the task bar. Please refer to the figure below:

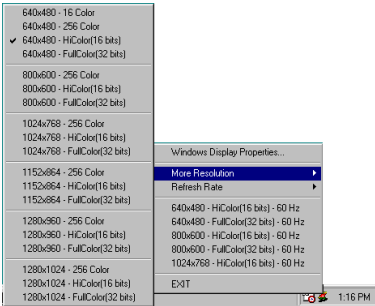

You can “right click” the mouse button on the Soft Jumpy icon. From the pop up menu you can then choose the “More Resolution” menu item, and see the resolution table pop up on left side. You then can directly choose the display resolution you want.

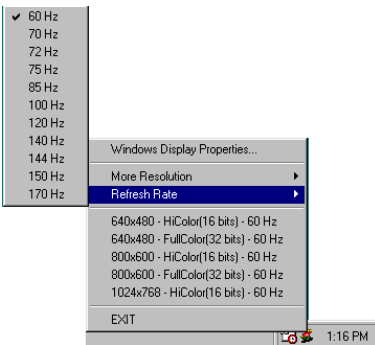

If you want to change the display adapter refresh rate, please choose the “Refresh Rate” from the pop up resolution table on left side, you then can directly choose the display refresh rate you want.

Be aware, that if your choose a higher refresh rate, you must make sure your display monitor can use this value. Otherwise, you may damage your display monitor.

You can refer to your display monitor user’s

manual for detailed specifications.

If you choose the “Windows Display Properties...”, please go to Chapter 3, section 3-2 for detailed information. The resolution shows below the “Refresh Rate” can let you fast change to the resolution and refresh rate that you often use.

Choose “Exit” to leave this program.

### 3-4. Installing the VGA Drivers for the Windows® NT 4.0 Server/Workstation

In this section we will show you how to install the VGA drivers to your Windows® NT 4.0 Server/Workstation operating system. All screen shots are from Windows® NT 4.0 server version. Before you install the VGA drivers, please install Windows® NT 4.0 Service Pack 5 (or latest version) first. Then you can install the VGA drivers.

#### Note 3-4-1

Details of the Windows® NT 4.0 Server/Workstation operating system are not mentioned in this manual. If you have any problems with the settings, operating or installing Windows® NT 4.0 Server/Workstation, please refer to your Windows® NT 4.0 Server/Workstation user's manual or other databases provided by the Microsoft® Corporation.

#### Note 3-4-2

For the Windows® NT 4.0 Server/Workstation operating system, you don't need to install any IDE-USB drivers. But you do have to install the Windows® NT 4.0 Service Pack 5 (or latest version) first.

**Step 1.** Reboot your computer system and select “Windows NT 4.0 (VGA)” from the Windows® NT 4.0 boot menu.

**Step 2.** Insert *ABIT SILURO Installation Disc* into your CD-ROM drive.

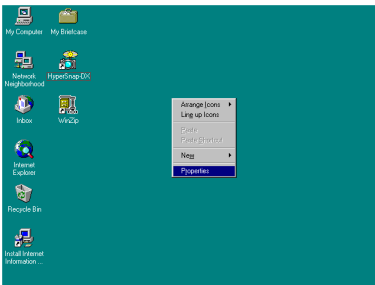

**Step 3.** From your Windows® NT 4.0 desktop wallpaper area, click the “**right**” button on your mouse. When the popup menu appears, choose “**Properties**” and click the left button on your mouse. This will take you to “**Display Properties**”.



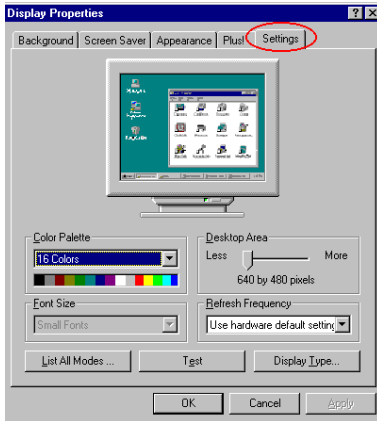

**Step 4.** Choose the “Settings” folder. You will see the current display settings. Click the “Display Type...” button and go to the next step.

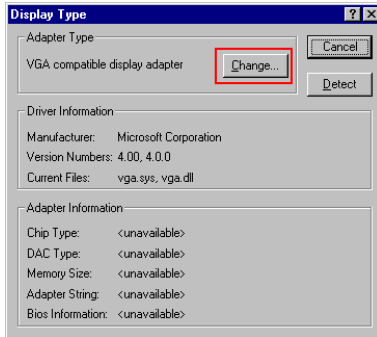

**Step 5.** A window with the title “Display Type” will appear on your screen. Click the “Change...” button.

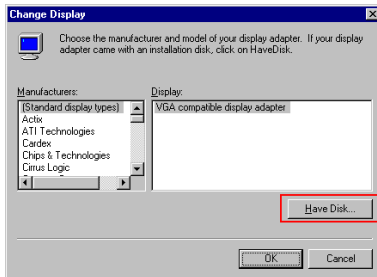

**Step 6.** A window with the title “Change Display” will appear on your screen. Click the “Have Disk...” button.

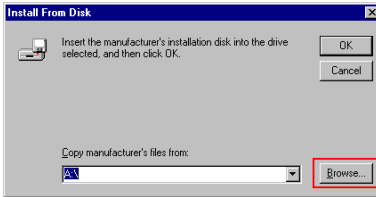

**Step 7.** A window with the title “**Install From Disk**” will appear on your screen. Click the “**Browse...**” button.

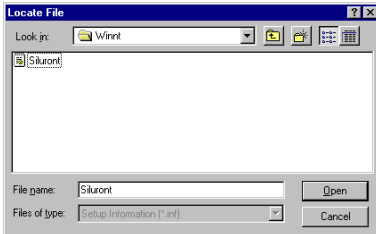

**Step 8.** A window with the title “**Locate File**” will appear on your screen. Choose the path “**D:\Driver\Winnt**” and click the “**Open**” button.

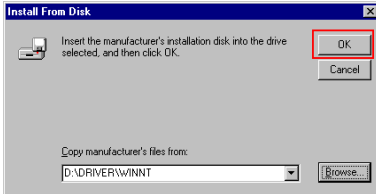

**Step 9.** A window with the title “**Install From Disk**” will appear on your screen. Click the “**OK**” button.

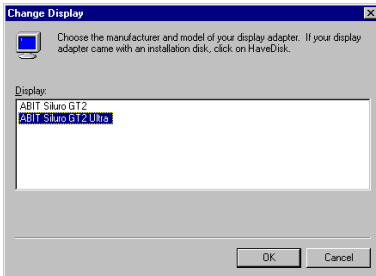

**Step 10.** A window with the title “**Change Display**” will appear on your screen. Choose the proper display card name and click the “**OK**” button.

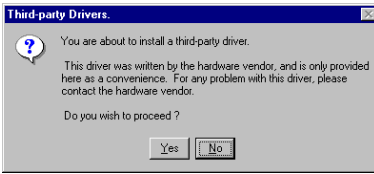

**Step 11.** A window with the title “**Third-Party Drivers**” will appear on your screen. Click the “**Yes**” button.

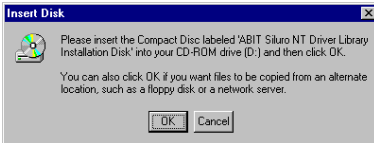

**Step 12.** A window with the title “**insert Disk**” will appear on your screen. Click the “**OK**” button.

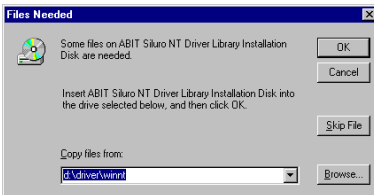

**Step 13.** A window with the title “**Files Needed**” will appear on your screen. Click the “**Browse...**” button.



**Step 14.** A window with the title “**Locate File**” will appear on your screen. Click the “**Open**” button and select the Path where the drivers are located. In this case we will choose “**D:\Driver\Winnt**”.

The code name of the CD-ROM drive will depend on how many devices are installed

on your computer system. Here it is shown as D:\.

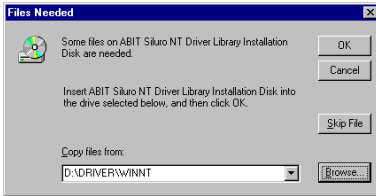

**Step 15.** A window with the title “**Files Needed**” will appear on your screen. Click the “**OK**” button to go on.

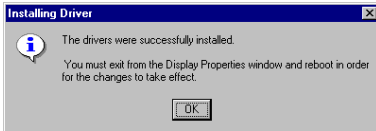

**Step 16.** A window with the title “**Installing Driver**” will appear on your screen. Click the “**OK**” button.

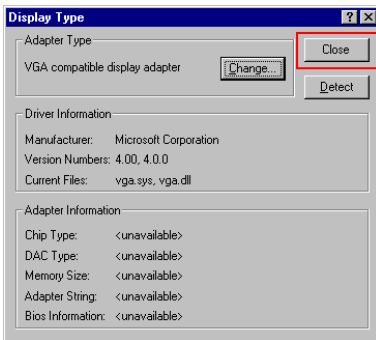

**Step 17.** A window with the title “**Display Type**” will appear on your screen. Click the “**Close**” button.

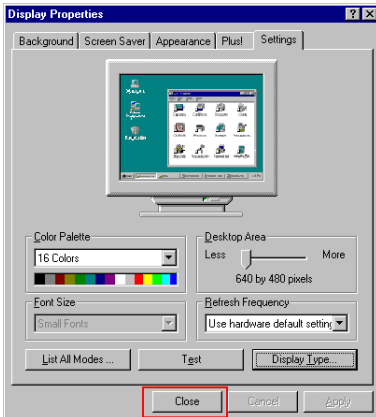

**Step 18.** A window with the title “**Display Properties**” will appear on your screen. Click the “**Close**” button.

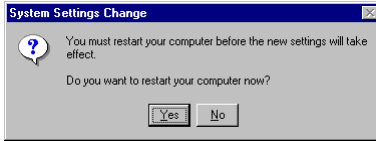

**Step 19.** A window with the title “**System Settings Change**” will appear on your screen. Click the “**Yes**” button to restart your computer.

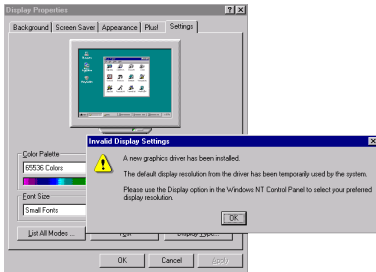

**Step 20.** When computer is rebooted, enter “**Windows® NT 4.0**” from the boot menu list. After the logon of Windows® NT, the “**Invalid Display Settings**” applet will show on your screen. Click the “**OK**” button.

### Note 3-4-3

This “**Invalid Display Settings**” window will only appear when you use new display drivers for the first time.

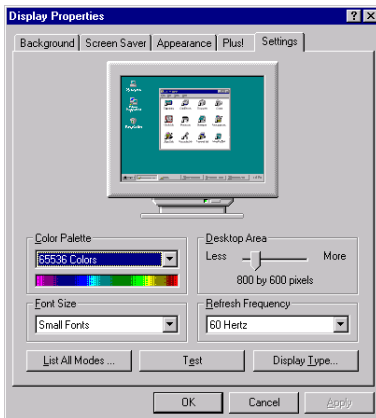

**Step 21.** You will see the color palette is now set to 65536 colors. You can reset the new settings for your display card.

Please refer the section 3-5, “**How to Use the Display Properties Settings in Windows® NT**” to change these settings.

## 3-5. How to Use the Display Properties Settings in Windows® NT

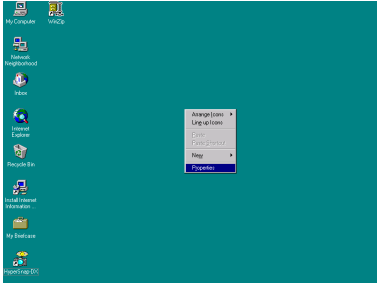

**Step 1.** When you have installed the drivers properly for the Windows® NT operating system, right click on the Windows® NT desktop wallpaper area and select the item “**Properties**”.

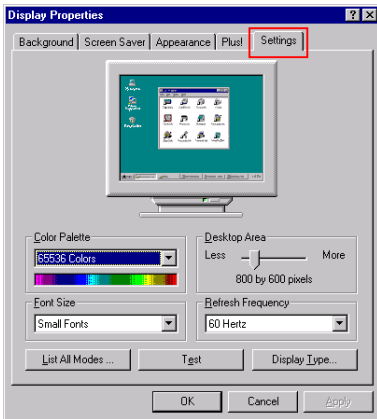

**Step 2.** The “**Display Properties**” item will appear on your screen. Select the “**Settings**” folder.

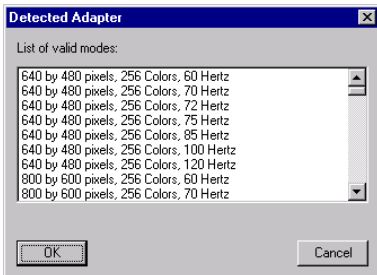

**Step 3.** Click the “**List All Modes...**” button. A window with the title “**Detected Adapter**” will appear on your screen. All modes that are available for your display card will be listed inside this Window. Choose the one that you want, and click the “**OK**” button for it to take effect.

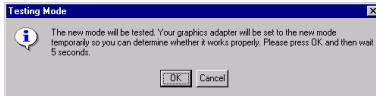

**Step 4.** Click the “**Test**” button. A window with the title “**Testing Mode**” will appear on your screen. Click the “**OK**” button to start testing your display card. You will see the test diagram on your screen.

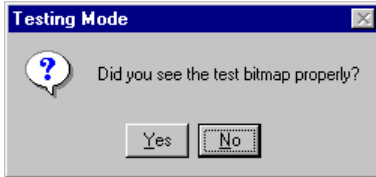

If the results are displayed properly, click the “**Yes**” button.

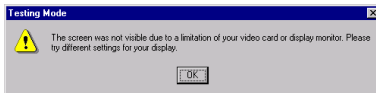

If the test results are unsuitable, this dialogue will ask you to change the settings for your display card.

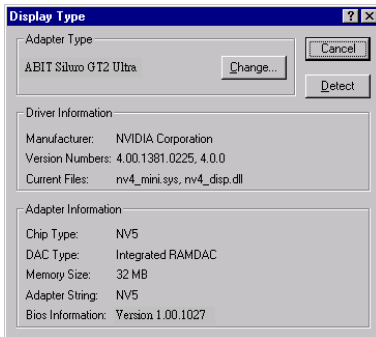

**Step 5.** Click the “**Display Type...**” button. A window with the title “**Display Type**” will appear on your screen. Click the “**OK**” button to start testing your display card. You will see the test diagram on your screen.

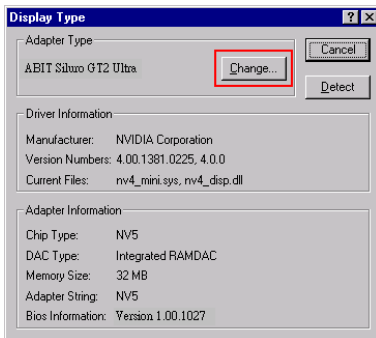

If you want to change your display driver, you can click the “**Change...**” button. The “**Change Display**” window will appear.

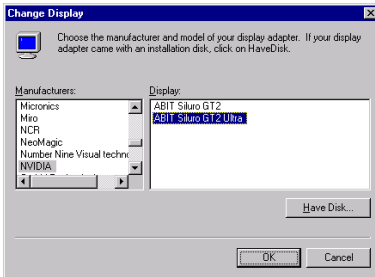

You can choose the proper manufacturer and display card model to install the driver. You also can choose the “**H**ave Disk...” button to install a driver that is not on the list.

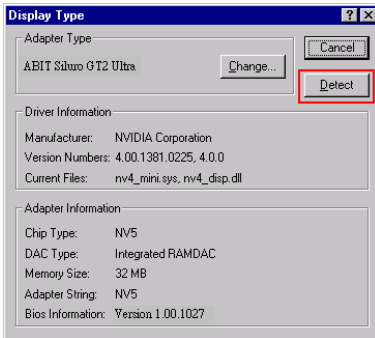

You can click the “**D**etect” button to let the program automatically find the driver for your display card.

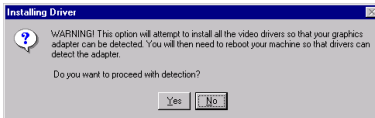

When finding the driver, a warning message will appear. Click the “**Y**es” button to continue.

Those are all the display setting items in Windows<sup>®</sup> NT. Carefully adjust the resolution and refresh frequency (a higher refresh frequency will make your screen appear more stable). If you are using an older display monitor, we suggest that you adjust the frequency from 60Hz, increasing the refresh frequency step by step. Sometimes, if your refresh frequency is at a setting above the monitor’s specifications, monitor failure or damage may result.



## 3-6. Before running Graphic Max

We have provided you with a tool for adjusting both the graphic processor working speed and the graphic memory speed. Please be warned that it may cause the damage to both the graphic processor and graphic memory if you use incorrect settings. Please read the following description carefully before running ABIT Graphic Max!

### Important Warning Message

1. ABIT does not provide any warranty or support for this utility. Use of this utility is at your own risk. This risk includes all damages caused by this utility. If you don't accept this warning, stop using this utility.
2. ABIT does not recommend any overclocking settings for your hardware. Overclocking can cause overheating which will damage your chip, although an excellent cooling fan is included on your Siluro display card.
3. If you are not acquainted with the display card hardware, we strongly recommend that you not to use this utility. Improper settings can cause unrecoverable damages to your graphics chip, your display card, and other components!

### Application Notes

1. This utility is provided for fine-tuning your display card to allow for maximum stability on your system. It is for Windows® 95/98 only.
2. Please select "Start->Programs->ABIT Graphic Max->Graphic Max" to launch GraphicMax.
3. If you have adjusted the Graphic Max settings and have problem after booting, you can boot into "Windows Safe Mode" and then run "Start->Programs->ABIT Graphic Max->Graphic Max Safe Mode Recovery" to clear previous settings.



Move the cursor to the "Install Graphic Max" and click on it. It will automatically install Graphic Max.

The figure below showing the Graphic Max screen will appear.

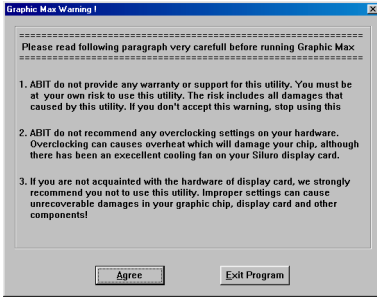

Each time you execute the program, you will see this warning message screen. Please read the entire message.

When you have read the entire message, click the “**A**gree” button to go on.

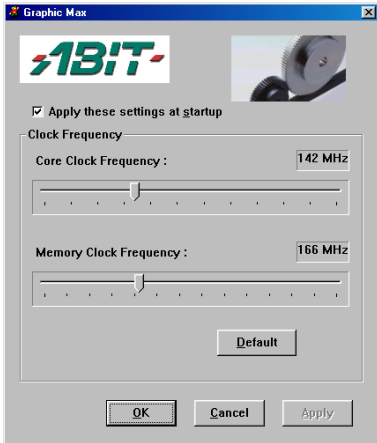

When the Graphic Max screen appears, you can use the two slide bars to adjust the “**C**ore **C**lock **F**requency” and the “**M**emory **C**lock **F**requency”. Please adjust these values very carefully, and make sure that you have already read the “Warning Message” on the prior page.

### 3-7. Installation of InterVideo WinDVD 2000

If you have a DVD-ROM, you can install this software DVD player application into your computer. Please insert the *ABIT Siluro Installation Disc* into the CD-ROM drive. It should execute the program automatically. If not, you can go to the CD location and execute the execution file at the root directory of this CD-Title. After it has been executed you will see the screen below.



Move the cursor to the "Install WinDVD" and click on it. This will begin installing the InterVideo WinDVD software into your computer.

**Note:** Follow each installation procedure shown on your screen. The software can be installed quite easily this way.

When you finish the installation, the program will ask you to reboot your computer. Reboot it and go to "Start" → "Program" → "InterVideo WinDVD" → "InterVideo WinDVD". Otherwise, you can start it by double clicking the WinDVD icon on your desktop. Then you will see the screen below.



You also can play DVD movies using the DVD player control panel.

For more detailed information about how to operate it, please check the help file in the InterVideo WinDVD program group.



## 3-8. Installing the Microsoft® DirectX® 7

For the best gaming capability, we suggest that you install the Microsoft® DirectX® 7 drivers. Some newer games will also ask you to install the DirectX drivers before you start them.

Installation of Microsoft® DirectX® 7 is very easy. Please insert the *ABIT Siluro Installation Disc* into the CD-ROM drive. It should execute the program automatically. If not, you can go to the CD location and execute the execution file at the root directory of this CD-Title. After it has been executed you will see the screen below.



Move the cursor to the "Install DirectX 7" and click on it.

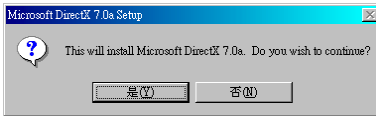

The install dialogue box will appear. Click the "Yes" button. This will begin installing the Microsoft® DirectX® 7 drivers into your computer.

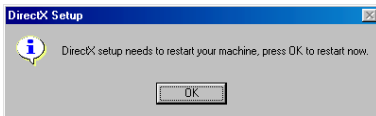

When the installation procedure is complete, a dialogue box will ask you to reboot your computer. Click the "OK" button to reboot your computer.

## 3-9. BIOS Flashing Utility

We will place the newest BIOS file on our WEB site (<http://www.abit.com.tw>), and you can check our WEB site to obtain the newest BIOS file.

We will tell you how to use the flash utility to flash the BIOS for the SILURO GT2 series display cards.

### Note 3-9-1

When you use the flash utility to flash the BIOS, the screen will be blank for about 20~25 seconds. This is a normal situation, not a malfunction. Do not reboot your computer during this period, or you may cause the flash to fail.

- Step 1.** Reboot your computer into DOS environment, or open a Windows 95/98 window to the DOS prompt.
- Step 2.** Insert SILURO GT2 Installation CD into your CD-ROM drive.
- Step 3.** Copy **DOS4GW.EXE** and **NVFLASH.EXE** to a new directory from path **D:\NVFLASH.** (D: refers to the CD-ROM drive letter)
- Step 4.** Copy the new BIOS binary file to the new directory.
- Step 5.** Change to the new directory and type the following command:  
**NVFLASH [Filename].** ([Filename] refers to the name of BIOS binary file.)  
Then press the "Enter" key. The program will begin flashing your display card BIOS.
- Step 6.** When the flash is complete (the screen will display images again), you must reboot your computer system to make flash take effect.

The following commands are for the Nvidia Flash ROM programming utility. v2.1, for your reference only.

Nvidia Flash ROM Programming Utility V2.1 Commands List:

Example of use: NVFLASH FULL.ROM

NVFLASH FULL.ROM      Reads and programs FLASH ROM to FULL.ROM

NVFLASH E	Software Erase
NVFLASH D	Dump ROM
NVFLASH C	Checks for supported EEROM
NVFLASH W	Write Protect
NVFLASH R	Reset Write Protect
NVFLASH F	Finds supported NV device
NVFLASH ?	Display options

### **3-10. How to Update the Current SILURO GT2 Series Products' Drivers & BIOS**

---

You may update the newest SILURO GT2 series products' drivers or BIOS files from your dealer or directly download them from our WEB site <http://www.abit.com.tw>.

## Chapter 4. Display Modes Table

The Table 4-1 and 4-2 below are for your reference only. The display mode will differ depending on your specific monitor, and the resulting display may not be identical to this table.

**Table 4-1. 2D Video Mode Resolution**

Resolution	BPP	Vertical Frequency (Hz)	Horizontal Frequency (KHz)
640 x 480	8/16/32	60/70/72/75/85/100/120/140/144/ 150/170/200/240	31/35/36/38/43/51/62/73/75/78/ 90/108/133
800 x 600	8/16/32	60/70/72/75/85/100/120/140/144/ 150/170/200/240	38/44/45/47/54/64/77/91/94/98/ 113/135/166
1024 x 768	8/16/32	60/70/72/75/85/100/120/140/144/ 150/170	48/56/58/60/69/82/99/117/120/ 126/144
1152 x 864	8/16	60/70/72/75/85/100/120/140/144/ 150	54/63/65/68/77/91/110/131/135 /141
1152 x 864	32	60/70/72/75/85/100/120/140	54/63/65/68/77/91/110/131
1280 x 1024	8/16	60/70/72/75/85/100/120	64/75/77/80/91/109
1280 x 1024	32	60/70/72/75/85/100	75/87/90/94/107
1600 x 1200	8/16	60/70/72/75/85	75/87/90/94
1600 x 1200	32	60/70/72/75	75/87/90/94
1920 x 1080	8/16	60/70/72/75/85	67/79/81/85/96
1920 x 1080	32	60/70/72	67/79/81
1920 x 1200	8/16	60/70/72/75	74/87/90/94
1920 x 1200	32	60	74
2048 x 1536	8/16	60	95

The display modes 2048 x 1536, 1920 x 1080 x 32 and 1920 x 1200 x 32 are only for the SILURO GT2 Ultra. The SILURO GT2V and SILURO GT2 do not support these modes.

**Table 4-2. Maximum 3D Mode Resolution**

Resolution	Color Depth	Single Buffer With below Z-buffer				Double Buffer With below Z-buffer			
		0 bits	8 bits	16 bits	24 bits	0 bits	8 bits	16 bits	24 bits
640 x 480	16 bit	Yes	Yes	Yes	Yes	Yes	Yes	Yes	Yes
	32 bit	Yes	Yes	Yes	Yes	Yes	Yes	Yes	Yes
800 x 600	16 bit	Yes	Yes	Yes	Yes	Yes	Yes	Yes	Yes
	32 bit	Yes	Yes	Yes	Yes	Yes	Yes	Yes	Yes
1024 x 768	16 bit	Yes	Yes	Yes	Yes	Yes	Yes	Yes	Yes
	32 bit	Yes	Yes	Yes	Yes	Yes	Yes	Yes	Yes
1280 x 1024	16 bit	Yes	Yes	Yes	Yes	Yes	Yes	Yes	Yes
	32 bit	Yes	Yes	Yes	Yes	Yes	Yes	Yes	Yes
1600 x 900	16 bit	Yes	Yes	Yes	Yes	Yes	Yes	Yes	Yes
	32 bit	Yes	Yes	Yes	Yes	Yes	Yes	Yes	Yes
1600 x 1200	16 bit	Yes	Yes	Yes	Yes	Yes	Yes	Yes	Yes
	32 bit	Yes	Yes	Yes	Yes	Yes	Yes	Yes	Yes
1920 x 1080	16 bit	Yes	Yes	Yes	Yes	Yes	Yes	Yes	Yes
	32 bit	Yes	Yes	Yes	Yes	Yes	Yes	Yes	Yes
1920 x 1200	16 bit	Yes	Yes	Yes	Yes	Yes	Yes	Yes	Yes
	32 bit	Yes	Yes	Yes	Yes	Yes	Yes	Yes	Yes



## Technical Support Form

 **Company Name:**

 **Phone Number:**

 **Contact Person:**

 **Fax Number:**

 **E-mail Address:**

<b>VGA Card Product Name</b>	*	<b>VGA Card BIOS Version</b>	*
<b>Motherboard Manufacturer, Model Name and Chipset type</b>	*	<b>VGA Card Software and Driver Version</b>	*
<b>Operating System Type</b>	*	<b>Monitor Manufacturer and Model</b>	*
<b>Hardware name</b>	<b>Type</b>	<b>Specifications</b>	
<b>CPU Type and Speed</b>	*		
<b>HDD</b> <input type="checkbox"/> IDE1 <input type="checkbox"/> IDE2			
<b>CD-ROM Drive</b> <input type="checkbox"/> IDE1 <input type="checkbox"/> IDE2			
<b>System Memory Size (SDRAM)</b>	*		
<b>Add-On Card</b>	*		



**Problem Description:**

---



---



---



---



---



---



---



**Note 4-1-1**

Information on items marked with an asterisk “\*” on the *Technical Support Form* are required.

If you encounter any problems and need help from our technical staff, please take the time to fill out the *Technical Support Form* and send it to your dealer or our technical support mailbox. The mailbox address is: [technical@abit.com.tw](mailto:technical@abit.com.tw). We will try to solve your problem as soon as possible. You must provide specific information on your equipment. Also please describe in detail the problems you encountered. It's helpful and enables our technicians to analyze your problems more quickly.

---

## **Appendix A    How to Get Technical Support**

---

(From our website) <http://www.abit.com.tw>

(In North America) <http://www.abit-usa.com>

(In Europe) <http://www.abit.nl>

Thank you for choosing ABIT products. ABIT sells all our products through distributors, resellers and system integrators, we have no direct sales to end-users. Before sending email for tech support please check with your resellers or integrators if you need any services, they are the ones who sold you your system and they should know best as to what can be done, how they serve you is a good reference for future purchases.

We appreciate every customer and would like to provide the best service to you. Providing fast service to our customers is our top priority. However we receive many phone calls and a huge amount of email from all over the world. At the present time it is impossible for us to respond to every single inquiry. Therefore it is quite possible that if you send an email to us that you may not receive a response.

We have done many compatibility tests and reliability tests to make sure our products have the best quality and compatibility. In case you need service or technical support, please understand the constraint we have and **always check with the reseller who sold the product to you first.**

To expedite service, we recommend that you follow the procedures outlined below before contacting us. With your help, we can meet our commitment to provide the best service to the **greatest number of ABIT customers:**

1. **Check the Manual.** It sounds simple but we have taken a lot of care in making a well written and thorough manual. It is full of information that doesn't only pertain to motherboards. The CD-ROM included with your board will have the manual as well as drivers. If you don't have either one go to our Program Download Area of the website or FTP server at: <http://www.abit.com.tw/download/index.htm>
2. **Download latest BIOS, software or drivers.** Please go to our Program Download area on our website to check to see if you have the latest BIOS. They are developed over periods of time to fix bugs or incompatibilities. **Also please make sure you have the latest drivers from your peripheral cards makers!**
3. **Check the ABIT Technical Terms Guide and FAQ on our website.** We are trying to expand and make the FAQs more helpful and information rich. Let us know if you have any suggestions. For hot topics check out our HOT FAQ!

4. **Internet Newsgroups.** They are a great source of information and many people there can offer help. ABIT's Internet News group, **alt.comp.periphs.mainboard.abit**, is an ideal forum for the public to exchange information and discuss experiences they have had with ABIT products. Many times you will see that your question has already been asked before. This is a public Internet news group and it is reserved for free discussions. Here is a list of some of the more popular ones:

[alt.comp.periphs.mainboard.abit](http://alt.comp.periphs.mainboard.abit)

[alt.comp.periphs.mainboard](http://alt.comp.periphs.mainboard)

[comp.sys.ibm.pc.hardware.chips](http://comp.sys.ibm.pc.hardware.chips)

[alt.comp.hardware.overclocking](http://alt.comp.hardware.overclocking)

[alt.comp.hardware.homebuilt](http://alt.comp.hardware.homebuilt)

[alt.comp.hardware.pc-homebuilt](http://alt.comp.hardware.pc-homebuilt)

**Ask your reseller.** Your ABIT authorized distributor should be able to provide the fastest solution to your technical problem. We sell our products through distributors who sell to resellers and stores. Your reseller should be very familiar with your system configuration and should be able to solve your problem much more efficiently than we could. After all, your reseller regards you as an important customer who may purchase more products and who can urge your friends to buy from him or her as well. They integrated and sold the system to you. They should know best what your system configuration is and your problem. They should have reasonable return or refund policies. How they serve you is also a good reference for your next purchase.

5. **Contacting ABIT.** If you feel that you need to contact ABIT directly you can send email to the ABIT technical support department. First, please contact the support team for the branch office closest to you. They will be more familiar with local conditions and problems and will have better insight as to which resellers offer what products and services. Due to the huge number of emails coming in every day and other reasons, such as the time required for problem reproduction, we will not be able to reply to every email. Please understand that we are selling through distribution channels and don't have the resources to serve every end-user. However, we will try to do our best to help every customer. Please also remember that for many of our technical support team English is a second language, you will have a better chance of getting a helpful answer if your question can be understood in the first place. Be sure to use very, simple, concise language that clearly states the problem, avoid rambling or flowery language and always list your system components. Here is the contact information for our branch offices:

**In North America and South America please contact:**

ABIT Computer (USA) Corporation  
46808 Lakeview Blvd.  
Fremont, California 94538 U.S.A.  
[sales@abit-usa.com](mailto:sales@abit-usa.com)  
[technical@abit-usa.com](mailto:technical@abit-usa.com)  
Tel: 1-510-623-0500  
Fax: 1-510-623-1092

**In the UK and Ireland:**

ABIT Computer Corporation Ltd.  
Caxton Place, Caxton Way,  
Stevenage, Herts SG1 2UG, UK  
[abituksales@compuserve.com](mailto:abituksales@compuserve.com)  
[abituktech@compuserve.com](mailto:abituktech@compuserve.com)  
Tel: 44-1438-741 999  
Fax: 44-1438-742 899

**In Germany and Benelux (Belgium, Netherlands, Luxembourg) countries:**

AMOR Computer B.V. (ABIT's European Office)  
Van Coehoornstraat 5a,  
5916 PH Venlo, The Netherlands  
[sales@abit.nl](mailto:sales@abit.nl)  
[technical@abit.nl](mailto:technical@abit.nl)  
Tel: 31-77-3204428  
Fax: 31-77-3204420

**All other territories not covered above please contact:**

**Taiwan Head Office**

When contacting our headquarters please note we are located in Taiwan and we are 8+ GMT time. In addition, we have holidays that may be different from those in your country.

**ABIT Computer Corporation**

3F-7, No. 79, Sec. 1, Hsin Tai Wu Rd.

Hsi Chi, Taipei Hsien

Taiwan, R.O.C.

[sales@abit.com.tw](mailto:sales@abit.com.tw)

[market@abit.com.tw](mailto:market@abit.com.tw)

[technical@abit.com.tw](mailto:technical@abit.com.tw)

Tel: 886-2-2698-1888

Fax: 886-2-2698-1811

**RMA Service.** If your system has been working but it just stopped, but you have not installed any new software or hardware recently, it is likely that you have a defective component. Please contact the reseller from whom you bought the product. You should be able to get RMA service there.

6. **Reporting Compatibility Problems to ABIT.** Because of tremendous number of email messages we receive every day, we are forced to give greater weight to certain types of messages than to others. For this reason, any compatibility problem that is reported to us, giving detailed system configuration information and error symptoms, will receive the highest priority. For the other questions, we regret that we may not be able to reply directly. But your questions may be posted to the internet news group in order that a larger number of users can have the benefit of the information. Please check the news group from time to time.

**Thank you, ABIT Computer Corporation**

**<http://www.abit.com.tw>**