

CONTENTS

INDEX	A
HOW TO INSTALL THE SOCKET 7 PROCESSOR ON THE ATC-5220 MAINBOARD.....	B
HOW TO USE THIS MANUAL.....	2
INTRODUCTION TO THE ATC-5220 MAINBOARD HARDWARE(Including easy installation).....	3
INSIDE THE ATC-5220 MAINBOARD PACKAGE.....	9
CHAPTER 1 Introduction.....	10
1-1 Soft-Off-Control.....	11
1-2 Wake-On-LAN.....	12
CHAPTER 2 Installation.....	13
2-1 Installation Procedure	13
2-2 CPU Installation	14
2-3 System Memory Installation.....	37
2-4 Connectors Description.....	38
2-5 IDE Driver Installation.....	43
2-6 VIA MVP3 AGP VGA Driver Installation.....	43
CHAPTER 3 Award BIOS Setup	44
3-1 Update BIOS Procedure	45
3-2 Award System BIOS Configuration Setup	46
Appendix A	A

HOW TO USE THIS MANUAL

To obtain maximum use from this manual it is suggested:

Read Page A COMPONENT LOCATION DIAGRAM where you find the mainboard layout diagram. Please refer to it when you configure the system.

Read about an overview of the mainboard features, packing contents, and how to upgrade as well as to change hardware configurations such as memory size, CPU type, jumper settings lists and connectors in the following categories:

INTRODUCTION TO THE ATC-5220 MAINBOARD HARDWARE INSIDE THE ATC-5220 MAINBOARD PACKAGE

Chapter 1 Introduction

Chapter 2 Installation

When you have finished reading of both chapter 1 and chapter 2, turn to **Chapter 3 Award BIOS Setup** where you will find the update BIOS procedure and the further information which is stored in the SETUP is the system hardware configuration.

Your system dealer will set up the mainboard according to your demand of the computer. It means that the current settings of your mainboard may not be the same as the defaults shown in this user's manual. If you need to change your configuration, please ask your dealer first. Be sure this will not void your system warranty, or ask your dealer to do it for you.

The product , ATC-5220 mainboard , quick description as following :

ATC-5220 mainboard supports 100MHz host clock Super 7 processor, ie. AMD K6-2, Cyrix M II. Of course , ATC-5220 mainboard also supports 66 ~ 83.3 MHz host clock Socket 7 processor, ie. Intel Pentium & Pentium processor with MMX technology, AMD K5/K6 , Cyrix 6X86/6X86MX , and IDT Winchip.

ATC-5220 mainboard, VIA MVP3 chipset, supports AGP slot for best performance of VGA display in 3D application .

REMARK

Intel® is a registered trademark of Intel Corporation.

All other brands and product names are trademarks registered trademarks of their respective companies.

INTRODUCTION TO THE ATC-5220 MAINBOARD HARDWARE(Including easy installation)

ATC-5220 mainboard supports 100MHz host clock Super 7 processors, ie. AMD K6-2, AMD K6-III, Cyrix MII. , also with Socket 7 processor from Intel , AMD , Cyrix and IDT . The AGP slot is the second important feature for this product .

It is important to remember that you must be set **Jumper JP5, Jumper JP6 , Jumper JP7, Jumper JP13, DIP switch SW1 and SW2** accurately, so that you can power up your system , correctly.

The followings are the description of these important DIP switch & jumpers :

SW1,JP7,JP5,JP6 : The completed jumper group to setup CPU and system frequency.

SW2, JP13 : The completed jumper group to setup CPU working voltage.

More detailed information as following:

SW1 : This DIP switch is to setup the CPU host clock Speed(Front Side Bus Speed) & the times of multiple with CPU host clock, for your installing CPU frequency.

JP5 & JP6(pair) : The jumper-pair are to select the Synchronous mode or the Asynchronous mode , comparing with CPU host clock and DRAM clock.

The Synchronous Mode : The speed of the DRAM clock is same as the CPU host clock, ie.

The CPU host clock is 100 MHz.

The DRAM clock is 100 MHz.

or,

The CPU host clock is 66 MHz.

The DRAM clock is 66 MHz.

The Asynchronous Mode : The speed of the DRAM clock is not same as the CPU host clock, ie.

The CPU host clock is 100 MHz.

The DRAM clock is 66 MHz.

JP7	: This jumper is to setup the frequency-ratio comparing With the PCI clock and the CPU host clock. Set JP7 to Pin2-3 :The ratio is 2 : 1 , ie. The CPU host clock is 66MHz. The PCI clock is 33 MHz. Set JP7 to Pin1-2 :The ratio is 3 : 1 , ie. The CPU host clock is 100 MHz. The PCI clock is 33 MHz.
SW2	: The Vcore, CPU core voltage selection, ranging from 2.2V, 2.8V, 2.9V, 3.2V, 3.3V and 3.5V.
JP13	: The selection of the Single voltage for CPU(P54C compatible) or the Dual voltage for CPU(P55C compatible). 2-3, 5-6 close : the single voltage support 1-2, 4-5 close : the dual voltage support

The following DIP switch & Jumper charts are the effective information for you to setup correct CPU and total system speed , when installing your system with ATC-5220 mainboard :

SW1 & JP7 setting

(The setting for CPU host clock , Times of multiple clock & PCI clock ratio)

SW1	SW1-1	SW1-2	SW1-3	JP7	SW1	SW1-4	SW1-5	SW1-6
66	OFF	OFF	OFF	2-3*	2.0x	ON	OFF	OFF
68.5	ON	ON	ON	2-3*	2.5x	ON	ON	OFF
75	OFF	ON	OFF	2-3*	3.0x	OFF	ON	OFF
83.3	ON	ON	OFF	2-3*	3.5x	OFF	OFF	OFF
95	ON	OFF	ON	1-2**	4.0x	ON	OFF	ON
100	OFF	OFF	ON	1-2**	4.5x	ON	ON	ON
112	OFF	ON	ON	1-2**	5.0x	OFF	ON	ON

* JP7: 2-3 close : the PCI clock ratio is 1 : 2 , it means :

If the CPU host clock is lower than 75 MHz ,
it is recommend to setup as 1 : 2.

** JP 7 : 1-2 close : the PCI clock ratio is 1 : 3 , it means :

If the CPU host clock is higher than 83.3 MHz ,
It is recommend to setup as 1 : 3.

JP5 & JP6 Setting

	JP 5	JP 6
ASYNC.*	2-3	1-2
SYNC.**	1-2	2-3

* ASYNC. mode : When the CPU host clock is 100 MHz , and the DRAM clock is 66 MHz .

** SYNC. mode : 1. When the CPU host clock is 100 MHz , and the SDRAM clock is followed PC-100 specification .
2. When the CPU host clock is 60 ~ 83.3 MHz , and the DRAM/SDRAM clock is not PC-100 spec. .

SW 2 Setting

Vcore	SW2-1	SW2-2	SW2-3	SW2-4	SW2-5
2.2V	OFF	ON	OFF	OFF	OFF
2.8V	OFF	OFF	OFF	ON	OFF
2.9V	ON	OFF	OFF	ON	OFF
3.2V	OFF	OFF	ON	ON	OFF
3.3V	ON	OFF	ON	ON	OFF
3.5V	ON	ON	ON	ON	OFF

JP13 setting

(The setting for Single/Dual Voltage supporting for Pentium level Processor)

Mode	JP13	
Single Voltage Mode(Vcore = Vi/o)*	2-3 close	5-6 close
Dual Voltage Mode(Vcore ≠Vi/o)**	1-2 close	4-5 close

* P54C mode (Single Voltage Mode) : supports for Intel Pentium, AMD-K5, Cyrix 6x86, IDT Win Chip C6.

** P55C mode (Dual Voltage Mode) : supports for Intel Pentium MMX , AMD-K6, AMD-K6-2, Cyrix 6x86L, Cyrix 6x86MX, Cyrix M II.

The following two examples will show you how to set JP 5, JP 6, JP7, JP13,

DIP_Switch SW1 & SW2 for most often usage CPU type .

The first example is for Intel Pentium[®] MMX 233 MHz processor.

The second example is for AMD-K6-2[®] 300 MHz (100 MHz host clock * 3) processor.

Example 1

Intel Pentium[™] MMX 233MHz

	JP 5	JP 6
Synchronous (CPU host clock & DRAM clock are the same)	Pin 1-2	Pin 2-3

CPU HOST CLOCK / PCI CLOCK	JP 7
66MHz/33MHz	Pin 2-3

SW2 (2.8V)

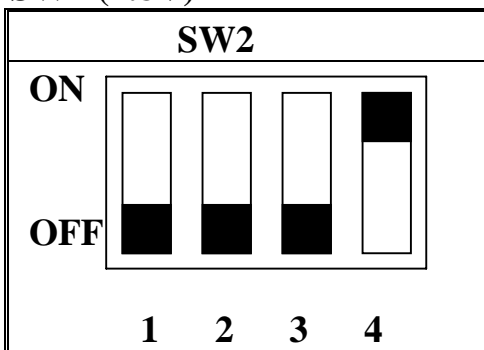

INTERNAL CPU CLOCK	SW1	Ext.x Frq.
233MHz	<p>ON</p> <p>OFF</p> <p>1 2 3 4 5 6</p>	66 x 3.5

Mode	JP13	
Dual Voltage Mode(Vcore ≠Vi/o)**	1-2 close	4-5 close

Example 2

AMD-K6-2[®] 300MHz

	JP 5	JP 6
Synchronous (CPU host clock & DRAM clock are same speed) *	Pin 1-2	Pin 2-3
Asynchronous (CPU host clock & DRAM clock are different speed) **	Pin 2-3	Pin 1-2

* Synchronous mode : The SDRAM module follows PC-100 spec.

** Asynchronous mode: The DRAM/SDRAM module isn't PC-100 spec.

CPU HOST CLOCK / PCI CLOCK	JP 7
100MHz/33MHz	Pin 1-2

SW2 (2.2V)

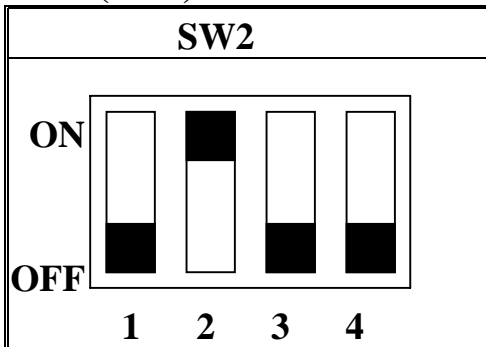

INTERNAL CPU CLOCK	SW1	Ext.x Frq.
300MHz	<p>ON</p> <p>OFF</p> <p>1 2 3 4 5 6</p>	100 x 3.0

Mode	JP13	
Dual Voltage Mode($V_{core} \neq V_{i/o}$)**	1-2 close	4-5 close

ATC-5220 mainboard supports 100MHz host clock Super 7 processors, ie. AMD

K6-2, Cyrix MII. , also with Socket 7 processor from intel , AMD , Cyrix and IDT . The AGP slot is the second important feature for this product .

Each ATC-5220 mainboard supports or contains the following components:

- 🖥 Supports Intel Pentium[®] (P54C) CPU operating from 75MHz to 200MHz, Intel Pentium MMX[™] 166~233MHz (P55C), AMD K5, AMD K6, AMD K6-2 Cyrix 6x86MX[™], MII, 6x86L.
- 🖥 VIA @ VT82C598AT.
- 🖥 Using three 168-pin DIMM sockets, provides three banks of 64-bit wide path up to 384MB SDRAM or 768 EDO DRAM (with parity chip ECC support).
- 🖥 Built-in Switching Voltage Regulator.(VRM 8.2 SPEC.)
- 🖥 Supports CPU core voltage range from 2.0V up to 3.5V.
- 🖥 Supports one AGP slot, four PCI slots with revision 2.1 interface compliant and two 16-bit ISA slots.
- 🖥 Dual Master IDE connectors support Ultra DMA/33, up to four devices in two channels for connecting of high capacity hard drive, CD-ROM disk drive, tape backup etc..
- 🖥 Two USB (Universal Serial Bus) connectors support up to 127 peripheral devices.
- 🖥 PS/2 keyboard connector and PS/2 mouse connector.
- 🖥 SMC-FDC37M669 high-speed Super Multi-I/O chipset.
- 🖥 Supports Infrared transfer (IrDA TX/RX) connection.
- 🖥 One FDC port supports two devices up to 2.88MB.
- 🖥 Two 16550A fast UARTs compatible serial ports.
- 🖥 One EPP/ECP mode parallel printer port.
- 🖥 Hardware Dimension is 305mm x 180mm(12" x 7.08"); ATX Form Factor.
- 🖥 ATX power supply connector.

INSIDE THE ATC-5220 MAINBOARD PACKAGE

The mainboard comes securely packed in a durable box and shipping carton. If any of the following items are missing or damaged, please contact your supplier.

Each mainboard contains:

<u>QTY</u>	<u>Description</u>	
1	Mainboard	: ATC-5220.
1	CD	: Enhanced IDE driver Award system BIOS Update Utility VIA MVP3 AGP VGA Vgart.vxd Utility VIA IRQ Routing Utility VIA MVP3 ACPI compliant utility
1	Cable	: Enhanced IDE cable.
1	Cable	: F.D.D. cable.
1	Manual	: User manual. (English version)

CHAPTER 1 INTRODUCTION

It is important to remember that you must be set **Jumper JP5, Jumper JP6 , Jumper JP7, Jumper JP13, DIP switch SW1 and SW2** accurately, so that you can power up your system , correctly.

The followings are the description of these important DIP switch & jumpers :

SW1,JP7,JP5,JP6 : The completed jumper group to setup CPU and system frequency.

SW2, JP13 : The completed jumper group to setup CPU working voltage.

The followings are the locations of these important DIP switch & jumpers :

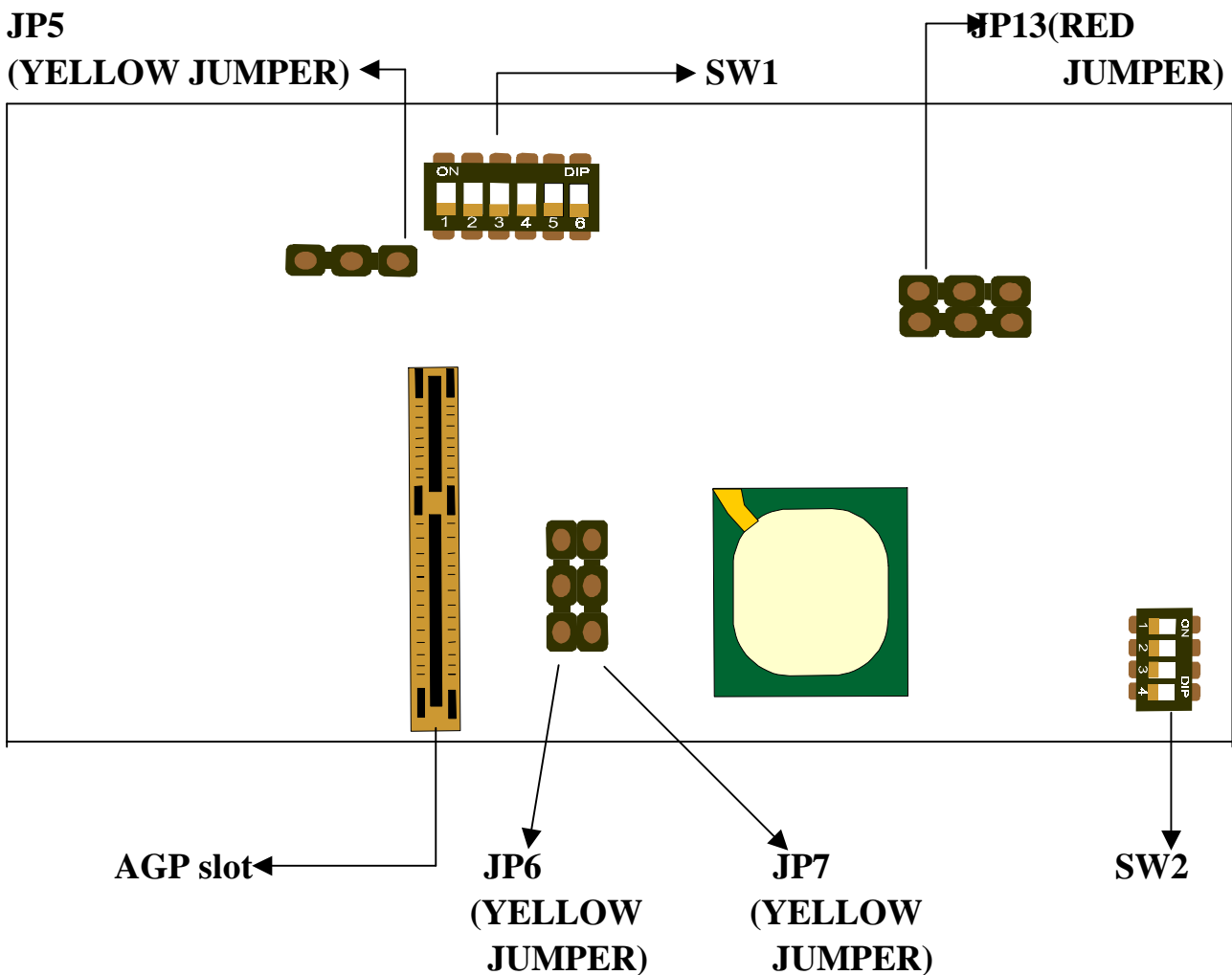

1-1 SOFTWARE POWER OFF CONTROL

The mainboard design supports Software Power Off Control feature through the SMM code in the BIOS under Windows 95/98, and MS-DOS operation system environment. This is Intel ATX form factor feature and you should use ATX power supply.

First, you should connect the power switch cable (provided by the ATX case supplier) to the connector “PS-ON” on the mainboard. In the BIOS screen of POWER MANAGEMENT SETUP’, choose “User Defined” (or “Min. Power Saving” or “Max. Power Saving”) in ‘Power Manager’ and choose “Yes” in ‘PM Control by APM’.

In Windows 95/98, if you would like to power off the system, you just choose “shutdown the computer ?” in the “Shut Down Windows“ from Windows 95/98, then the system power will be off directly, and become the stand-by status. If you would like to restart the system, just press the power switch button, and the system will be powered on.

Note : If you will leave your system for several days, we suggest you use hardware power off to shutdown your system.

1-2 Wake-On-LAN

The remote Wake-On-LAN mode of operation is a mechanism that uses Advanced Micro Device Magic Packet technology to power up a sleeping workstation on the network. This mechanism is accomplished when the LAN card receives a specific packet of information, called a Magic Packet, addressed to the node on the network. For additional protection, Secure ON is an optional security feature that can be added to the Magic Packet that requires a password to power up the sleeping workstation. When the LAN card is in remote Wake-On-LAN mode, main system power can be shut down leaving power only for the LAN card and auxiliary power recondition.

The LAN card performs no network activities while in the remote Wake-On-LAN mode of operation. It only monitors the network for receipt of a Magic Packet. If a Magic Packet is addressed to the LAN card on the network, the LAN card wake up the system. If the Secure ON feature has been enabled, the password added to the Magic Packet is also verified prior to waking up the system.

WOL LAN card will provide a 3-pin line to connect the WOL connector on the mainboard.

CAUTION :

For Wake-on-LAN, the +5V standby line for the power supply must capable of Delievring +5V $\pm 5\%$ at 720mA. Failure to provide adequate standby current when implementing Wake-on-LAN, can damage the power supply.

Before you enable Wake-on-LAN function, first check your power supply specification to meet the above requirement or not.

CHAPTER 2 INSTALLATION

2-1 INSTALLATION PROCEDURE

Before installing the computer, please prepare all components such as CPU, DRAM; peripherals such as hard drive, keyboard, CD-ROM disk drive and accessories such as cables. Then, install the system as following:

1. Plug CPU, heat sink, cooling fan and DRAM modules into the ATC-5220 mainboard.
2. Set jumpers based on your configuration.
3. Set DIP switch based on your configuration.
4. Plug add-on cards into PCI/ISA slots, if needed.
5. Connect the power supply.
6. Connect I/O and other cables to the system.
7. Make sure all components and devices are well connected, turn on the power and setup System BIOS based on your configuration.
8. Install peripheral devices, add-on card drivers and run the system configuration program.

If all of above procedures are running successfully, turn it off and screw the chassis cover to the case, and then connect external devices which are cabled to the system.

2-2 CPU INSTALLATION

ATC-5220 supports one Pentium level CPU.

For installation, please notice CPU pin 1 must align with the ZIF socket 7 pin 1 location. Before you install or upgrade your CPU, please read CPU guide from CPU manufacturer to make sure the CPU voltage specification. Then choose the right installation in section 2-2-1 based on your CPU type / brand and follow the description to setup DIP Switch & Jumpers.

ATC-5220 uses the following DIP Switch & Jumpers for the user to install CPU easily.

SW1 (1-3) for External clock and SW1 (4-6) for Frequency_Ratio.

SW2 for different CPU voltage value;

JP13 for Single/Dual CPU Voltage selection.

JP7 for CPU host clock/PCI clock ratio selection , 2 : 1 or 3 : 1 .

JP5 & JP6 for CPU host clock/DRAM clock ratio selection , Asynchronous or Synchronous .

The following DIP switch & Jumper charts are the effective information for you to setup correct CPU and total system speed , when installing your system with ATC-5220 mainboard :

SW1 & JP7 setting

(The setting for CPU host clock , Times of multiple clock & PCI clock ratio)

SW1	SW1-1	SW1-2	SW1-3	JP7	SW1	SW1-4	SW1-5	SW1-6
66	OFF	OFF	OFF	2-3*	2.0x	ON	OFF	OFF
68.5	ON	ON	ON	2-3*	2.5x	ON	ON	OFF
75	OFF	ON	OFF	2-3*	3.0x	OFF	ON	OFF
83.3	ON	ON	OFF	2-3*	3.5x	OFF	OFF	OFF
95	ON	OFF	ON	1-2**	4.0x	ON	OFF	ON
100	OFF	OFF	ON	1-2**	4.5x	ON	ON	ON
112	OFF	ON	ON	1-2**	5.0x	OFF	ON	ON

* JP7: 2-3 closed : the PCI clock ratio is 1 : 2 , it means :

If the CPU host clock is lower than 75 MHz,
it is recommend to setup as 1 : 2.

** JP 7 : 1-2 closed : the PCI clock ratio is 1 : 3 , it means :

If the CPU host clock is higher than 83.3 MHz,
it is recommend to setup as 1 : 3.

JP5 & JP6 Setting

	JP 5	JP 6
ASync.*	2-3	1-2
SYnc.**	1-2	2-3

* ASync. mode : When the CPU host clock is 100 MHz , and the DRAM clock is 66 MHz .

** SYnc. mode : 1. When the CPU host clock is 100 MHz , and the SDRAM clock is followed PC-100 specification .
2. When the CPU host clock is 60 ~ 83.3 MHz , and the DRAM/SDRAM clock is not PC-100 spec. .

SW 2 Setting

Vcore	SW2-1	SW2-2	SW2-3	SW2-4
2.2V	OFF	ON	OFF	OFF
2.3V	ON	ON	OFF	OFF
2.4V	OFF	OFF	ON	OFF
2.7V	ON	ON	ON	OFF
2.8V	OFF	OFF	OFF	ON
2.9V	ON	OFF	OFF	ON
3.2V	OFF	OFF	ON	ON
3.3V	ON	OFF	ON	ON
3.5V	ON	ON	ON	ON

JP13 setting

(The setting for Single/Dual Voltage supporting for Pentium level Processor)

Mode	JP13	
Single Voltage Mode($V_{core} = V_{i/o}$)*	2-3 closed	5-6 closed
Dual Voltage Mode($V_{core} \neq V_{i/o}$)**	1-2 closed	4-5 closed

* P54C mode (Single Voltage Mode) : supports for Intel Pentium, AMD-K5, Cyrix 6x86, IDT Win Chip C6.

** P55C mode (Dual Voltage Mode) : supports for Intel Pentium MMX , AMD-K6, AMD-K6-2, Cyrix 6x86L, Cyrix 6x86MX, Cyrix M II.

2-2-1 CPU TYPE SELECTION

A. INTEL PENTIUM® CPU (P54C)

- ※ **P54C VRE : 3.400V~3.600V** (The fourth line of the mark on the under-side of the processor contains a code that identifies the voltage level type. V is VRE, S is standard.)

SW2(3.5V)

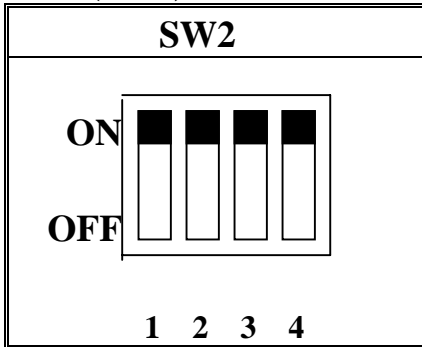

- ※ **P54C STD : 3.135V ~ 3.600V** (The fourth line of the mark on the under-side of the processor contains a code that identifies the voltage level type. V is VRE, S is standard.)

SW2(3.3V)

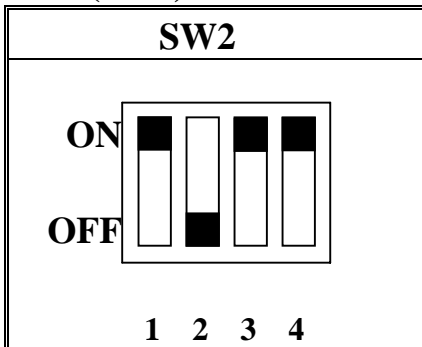

The settings of JP5, JP6 and JP7 are depending on the CPU host clock. Before you do the following CPU settings, please set JP5, JP6 and JP7 to “Pin1-2, Pin2-3 and Pin2-3” position.

CPU host clock/DRAM/PCI clock	JP 5	JP 6	JP 7
66MHz/66MHz/33MHz	Pin 1-2	Pin 2-3	Pin 2-3

Mode	JP13	
Single Voltage Mode($V_{core} = V_{i/o}$)*	2-3 closed	5-6 closed

Intel Pentium® 100MHz

INTERNAL CPU CLOCK	SW1	Ext.x Frq.
100MHz	ON  OFF	66 x 1.5

Intel Pentium® 133MHz

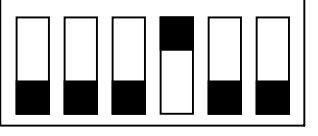
INTERNAL CPU CLOCK	SW1	Ext.x Frq.
133MHz	ON  OFF	66 x 2.0

Intel Pentium® 166MHz

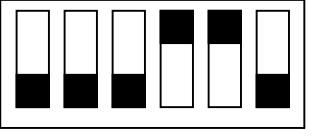
INTERNAL CPU CLOCK	SW1	Ext.x Frq.
166MHz	ON  OFF	66 x 2.5

Intel Pentium® 200MHz

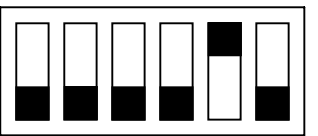
INTERNAL CPU CLOCK	SW1	Ext.x Frq.
200MHz	ON  OFF	66 x 3.0

B. INTEL PENTIUM MMX™ CPU (P55C)

SW2(2.8V)

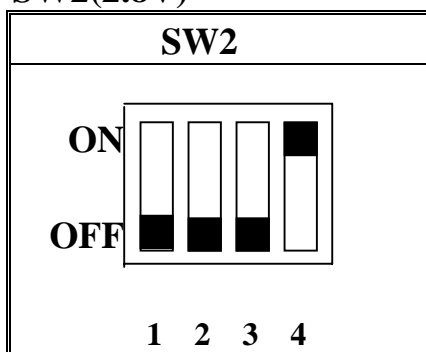

The settings of JP5, JP6 and JP7 are depending on the CPU host clock. Before you do the following CPU settings, please set JP5, JP6 and JP7 to “Pin1-2, Pin2-3 and Pin2-3” position.

CPU host clock/DRAM/PCI clock	JP 5	JP 6	JP 7
66MHz/66MHz/33MHz	Pin 1-2	Pin 2-3	Pin 2-3

Mode	JP13	
Dual Voltage Mode($V_{core} \neq V_{i/o}$)**	1-2 closed	4-5 closed

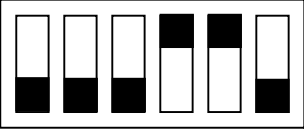
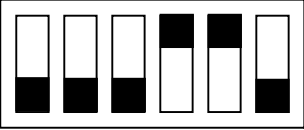

B-1. Intel Pentium™ MMX 166MHz

INTERNAL CPU CLOCK	SW1	Ext.x Frq.
166MHz	<p>ON </p> <p>OFF </p> <p>1 2 3 4 5 6</p>	66 x 2.5

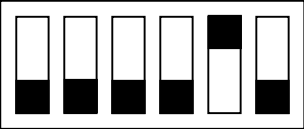
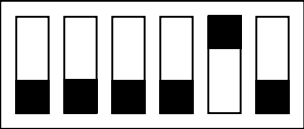
B-2. Intel Pentium™ MMX 200MHz

INTERNAL CPU CLOCK	SW1	Ext.x Frq.
200MHz	<p>ON </p> <p>OFF </p> <p>1 2 3 4 5 6</p>	66 x 3.0

B-3. Intel Pentium™ MMX 233MHz

INTERNAL CPU CLOCK	SW1	Ext.x Frq.
233MHz	<p>ON </p> <p>OFF </p> <p>1 2 3 4 5 6</p>	66 x 3.5

C. Cyrix 6x86MX CPU

SW2 (2.9V)

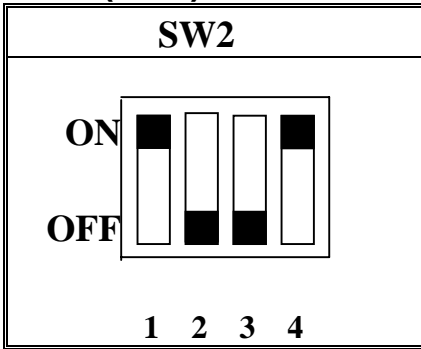

The settings of JP5, JP6 and JP7 are depending on the CPU host clock. Before you do the following CPU settings, please set JP5, JP6 and JP7 to “Pin1-2, Pin2-3 and Pin2-3” position.

CPU host clock/DRAM/PCI clock	JP 5	JP 6	JP 7
	Pin 1-2	Pin 2-3	Pin 2-3

Mode	JP13	
Dual Voltage Mode($V_{core} \neq V_{i/o}$)**	1-2 closed	4-5 closed

C-1. Cyrix 6x86MX PR166 @ 66MHz Bus 2x

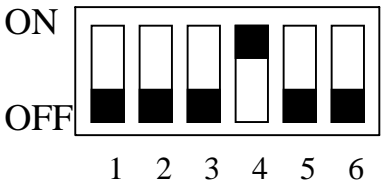
INTERNAL CPU CLOCK	SW1	Ext.x Frq.
PR166	ON  OFF	66 x 2.0

C-2. Cyrix 6x86MX PR200MHz @ 66MHz Bus 2.5x

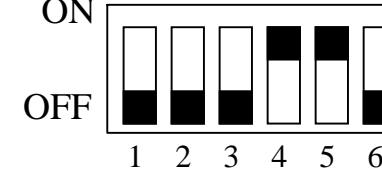
INTERNAL CPU CLOCK	SW1	Ext.x Frq.
PR200	ON  OFF	66 x 2.5

C-3. Cyrix 6x86MX PR233 @ 66MHz Bus 3x

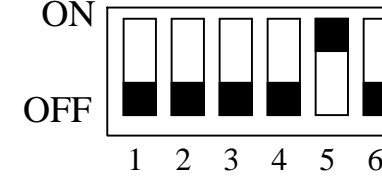
INTERNAL CPU CLOCK	SW1	Ext.x Frq.
PR233	ON  OFF	66 x 3.0

C-4. Cyrix 6x86MX PR233 @ 75MHz Bus 2.5x

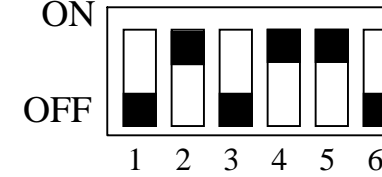
INTERNAL CPU CLOCK	SW1	Ext.x Frq.
PR233	ON  OFF	75 x 2.5

D. Cyrix MII CPU

D-1 Cyrix MII 300MHz @ 66MHz Bus 3.5x

SW2(2.9V)

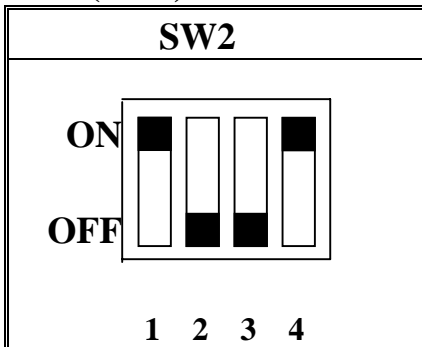

The settings of JP5, JP6 and JP7 are depending on the CPU host clock. Before you do the following CPU settings, please set JP5, JP6 and JP7 to “Pin1-2, Pin2-3 and Pin2-3” position.

CPU host clock/DRAM/PCI clock	JP 5	JP 6	JP 7
66MHz/66MHz/33MHz	Pin 1-2	Pin 2-3	Pin 2-3

JP13 Setting

Mode	JP13	
Dual Voltage Mode($V_{core} \neq V_{i/o}$)**	1-2 closed	4-5 closed

INTERNAL CPU CLOCK	SW1	Ext.x Frq.
MII 300MHz	<p>The diagram shows a 6-position switch labeled SW1. All six positions have the bottom half shaded black, indicating they are all in the OFF position.</p>	66 x 3.5

D-2 Cyrix MII 75MHz Bus

SW2(2.9V)

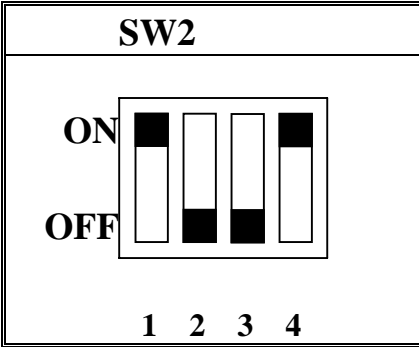

The settings of JP5, JP6 and JP7 are depending on the CPU host clock. Before you do the following CPU settings, please set JP5, JP6 and JP7 to “Pin1-2, Pin2-3 and Pin2-3” position.

CPU host clock/DRAM/PCI clock	JP 5	JP 6	JP 7
75MHz/75MHz/37.5MHz	Pin 1-2	Pin 2-3	Pin 2-3

JP13 Setting

Mode	JP13	
Dual Voltage Mode($V_{core} \neq V_{i/o}$)**	1-2 closed	4-5 closed

INTERNAL CPU CLOCK	SW1	Ext.x Frq.
MII 300MHz		75 x 3.0
MII 366MHz		75 x 4.0

D-3 Cyrix MII 83MHz Bus

SW2(2.9V)

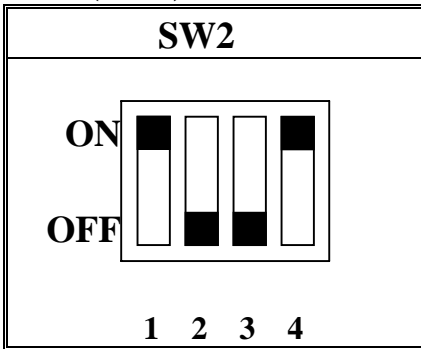

The settings of JP5, JP6 and JP7 are depending on the CPU host clock. Before you do the following CPU settings, please set JP5, JP6 and JP7 to “Pin1-2, Pin2-3 and Pin1-2” position.

CPU host clock/DRAM/PCI clock	JP 5	JP 6	JP 7
83.3MHz/83.3MHz/27.7MHz	Pin 1-2	Pin 2-3	Pin 1-2

JP13 Setting

Mode	JP13	
Dual Voltage Mode($V_{core} \neq V_{i/o}$)**	1-2 closed	4-5 closed

INTERNAL CPU CLOCK	SW1	Ext.x Frq.
MII 333MHz		83 x 3.0
MII 366MHz		83 x 3.5

D-4 Cyrix MII 100MHz Bus

SW2(2.9V)

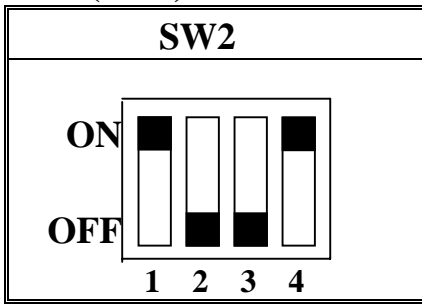

The settings of JP5, JP6 and JP7 are depending on the CPU host clock. Before you do the following CPU settings, please set JP5, JP6 and JP7 to “Pin1-2, Pin2-3 and Pin1-2” position for PC-100 SDRAM module or set JP5, JP6 and JP7 to “Pin2-3, Pin1-2 and Pin1-2” position for non PC-100 SDRAM module or EDO DIMM module.

CPU host clock/DRAM/PCI clock	JP 5	JP 6	JP 7
100MHz/100MHz/33MHz*	Pin 1-2	Pin 2-3	Pin1-2
100MHz/66MHz/33MHz**	Pin 2-3	Pin 1-2	Pin 1-2

* Please use for PC-100 SDRAM module

** Please use non PC-100 SDRAM module or EDO DIMM module

JP13 Setting

Mode	JP13	
Dual Voltage Mode($V_{core} \neq V_{i/o}$)**	1-2 closed	4-5 closed

INTERNAL CPU CLOCK	SW1	Ext.x Frq.
MII 366MHz	<p>The diagram shows a 6-position switch labeled SW1. The ON position is indicated by a black bar at the top, and the OFF position is indicated by a black bar at the bottom. Positions 1, 2, and 6 are OFF, while positions 3, 4, and 5 are ON.</p>	100 x 2.5
MII 380MHz	<p>The diagram shows a 6-position switch labeled SW1. The ON position is indicated by a black bar at the top, and the OFF position is indicated by a black bar at the bottom. Positions 1, 2, and 6 are OFF, while positions 3, 4, and 5 are ON.</p>	100 x 3.0

* If your CPU type is not included in this section, please set SW1 according to your CPU working frequency. (Please refer to page 14,15.)

E. Cyrix 6x86L CPU (dual voltage)

SW2 (2.8V)

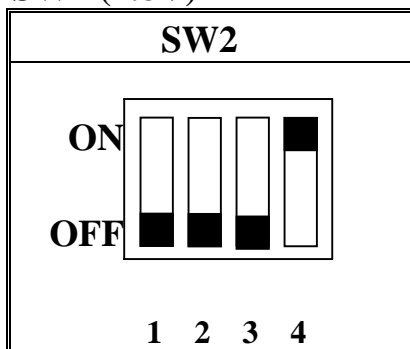

The settings of JP5, JP6 and JP7 are depending on the CPU host clock. Before you do the following CPU settings, please set JP5, JP6 and JP7 to “Pin1-2, Pin2-3 and Pin2-3” position.

CPU host clock/DRAM/PCI clock	JP 5	JP 6	JP 7
	Pin 1-2	Pin 2-3	Pin 2-3

JP13 Setting

Mode	JP13	
Dual Voltage Mode($V_{core} \neq V_{i/o}$)**	1-2 closed	4-5 closed

E-1. Cyrix 6x86L PR166+

INTERNAL CPU CLOCK	SW1	Ext.x Frq.
PR166+	ON OFF 1 2 3 4 5 6	66 x 2.0

F. AMD-K5 CPU Series

SW2(3.5V)

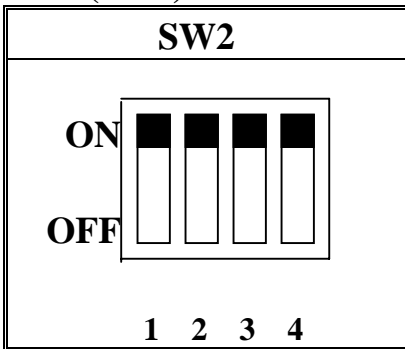

The settings of JP5, JP6 and JP7 are depending on the CPU host clock. Before you do the following CPU settings, please set JP5, JP6 and JP7 to “Pin1-2, Pin2-3 and Pin2-3” position.

CPU host clock/DRAM/PCI clock	JP 5	JP 6	JP 7
66MHz/66MHz/33MHz*	Pin 1-2	Pin 2-3	Pin2-3

JP13 Setting

Mode	JP13	
Single Voltage Mode($V_{core} = V_{i/o}$)*	2-3 closed	5-6 closed

F-1. AMD-K5 PR100

INTERNAL CPU CLOCK	SW1	Ext.x Frq.
PR100	<p>The diagram shows a switch labeled SW1 with six positions numbered 1, 2, 3, 4, 5, and 6. To the left of the switch, 'ON' is indicated at the top and 'OFF' at the bottom. Each position has a vertical bar with a black bottom section, indicating the 'OFF' state.</p>	66 x 1.5

F-2. AMD-K5 PR133

INTERNAL CPU CLOCK	SW1	Ext.x Frq.
PR133	<p>ON</p> <p>OFF</p> <p>1 2 3 4 5 6</p>	66 x 1.5

F-3. AMD-K5 PR166MHz

INTERNAL CPU CLOCK	SW1	Ext.x Frq.
PR166	<p>ON</p> <p>OFF</p> <p>1 2 3 4 5 6</p>	66 x 2.5

G. AMD-K6 CPU

The settings of JP5, JP6 and JP7 are depending on the CPU host clock. Before you do the following CPU settings, please set JP5, JP6 and JP7 to “Pin1-2, Pin2-3 and Pin2-3” position.

CPU host clock/DRAM/PCI clock	JP 5	JP 6	JP 7
66MHz/66MHz/33MHz	Pin 1-2	Pin 2-3	Pin 2-3

JP13 Setting

Mode	JP13	
Dual Voltage Mode($V_{core} \neq V_{i/o}$)**	1-2 closed	4-5 closed

G-1. AMD-K6 166MHz

SW2(2.9V)

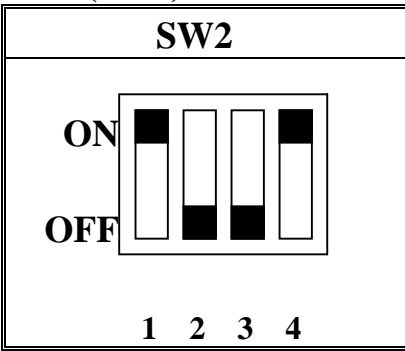

INTERNAL CPU CLOCK	SW1	Ext.x Frq.																																
166MHz	<table border="1"> <thead> <tr> <th colspan="2"></th> <th colspan="6">SW1</th> </tr> </thead> <tbody> <tr> <td>ON</td> <td></td> <td></td> <td></td> <td>■</td> <td>■</td> <td></td> <td></td> </tr> <tr> <td>OFF</td> <td></td> <td>■</td> <td>■</td> <td>■</td> <td></td> <td></td> <td>■</td> </tr> <tr> <td colspan="2"></td> <td>1</td> <td>2</td> <td>3</td> <td>4</td> <td>5</td> <td>6</td> </tr> </tbody> </table>			SW1						ON				■	■			OFF		■	■	■			■			1	2	3	4	5	6	66 x 2.5
		SW1																																
ON				■	■																													
OFF		■	■	■			■																											
		1	2	3	4	5	6																											

G-2. AMD-K6 200MHz

SW2(2.9V)

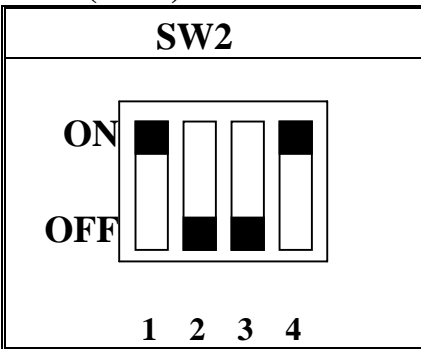

INTERNAL CPU CLOCK	SW1	Ext.x Frq.																																
200MHz	<table border="1"> <thead> <tr> <th colspan="2"></th> <th colspan="6">SW1</th> </tr> </thead> <tbody> <tr> <td>ON</td> <td></td> <td></td> <td></td> <td></td> <td>■</td> <td></td> <td></td> </tr> <tr> <td>OFF</td> <td></td> <td>■</td> <td>■</td> <td>■</td> <td>■</td> <td></td> <td>■</td> </tr> <tr> <td colspan="2"></td> <td>1</td> <td>2</td> <td>3</td> <td>4</td> <td>5</td> <td>6</td> </tr> </tbody> </table>			SW1						ON					■			OFF		■	■	■	■		■			1	2	3	4	5	6	66 x 3.0
		SW1																																
ON					■																													
OFF		■	■	■	■		■																											
		1	2	3	4	5	6																											

G-3a. AMD-K6 233MHz

SW2(3.2V)

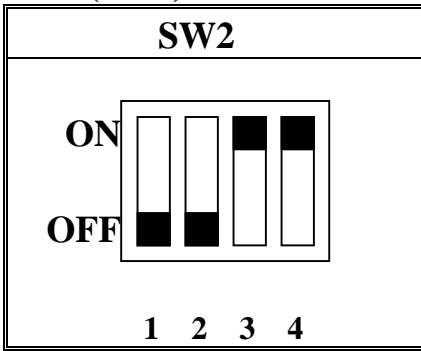

INTERNAL CPU CLOCK	SW1	Ext.x Frq.
233MHz	<p>ON</p> <p>OFF</p> <p>1 2 3 4 5 6</p>	66 x 3.5

G-3b. AMD-K6-2 233MHz

SW2(2.2V)

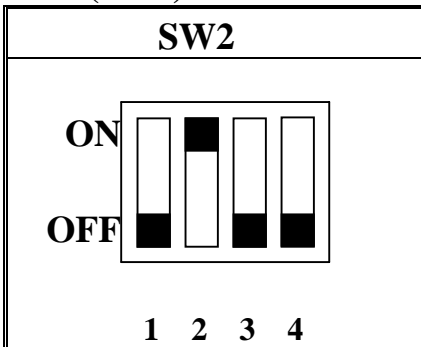

INTERNAL CPU CLOCK	SW1	Ext.x Frq.
233MHz	<p>ON</p> <p>OFF</p> <p>1 2 3 4 5 6</p>	66 x 3.5

G-4 AMD-K6/K6-2 266 MHz, AMD-K6 300MHz

SW2(2.2V)

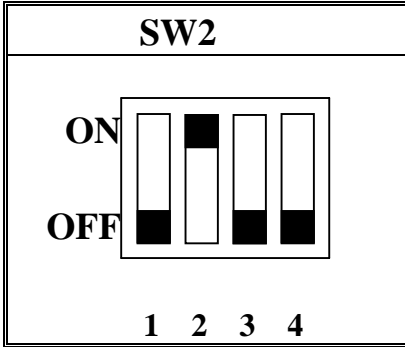

INTERNAL CPU CLOCK	SW1	Ext.x Frq.
266MHz		66 x 4.0
300MHz		66 x 4.5

The settings of JP5, JP6 and JP7 are depending on the CPU host clock. Before you do the following CPU settings, please set JP5, JP6 and JP7 to “Pin1-2, Pin2-3 and Pin2-3” position.

CPU host clock/DRAM/PCI clock	JP 5	JP 6	JP 7
66MHz/66MHz/33MHz	Pin 1-2	Pin 2-3	Pin2-3

JP13 Setting

Mode	JP13	
Dual Voltage Mode($V_{core} \neq V_{i/o}$)**	1-2 closed	4-5 closed

G-5 AMD-K6-2 333MHz (option)

SW2(2.2V)

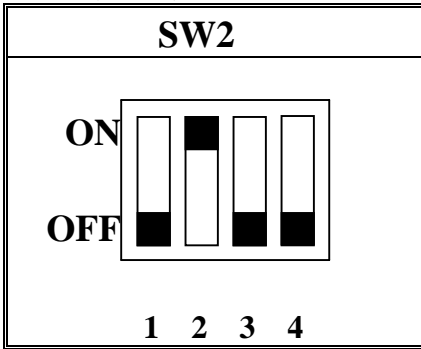

INTERNAL CPU CLOCK	SW1	Ext.x Frq.
333MHz		95 x 3.5

The settings of JP5, JP6 and JP7 are depending on the CPU host clock. Before you do the following CPU settings, please set JP5, JP6 and JP7 to “Pin1-2, Pin2-3 and Pin1-2” position for PC-100 SDRAM module or set JP5, JP6 and JP7 to “Pin2-3, Pin1-2 and Pin1-2” position for non PC-100 SDRAM module or EDO DIMM module.

CPU host clock/DRAM/PCI clock	JP 5	JP 6	JP 7
95MHz/95MHz/31.7MHz*	Pin 1-2	Pin 2-3	Pin1-2
95MHz/66MHz/31.7MHz**	Pin 2-3	Pin 1-2	Pin 1-2

* Please use for PC-100 SDRAM module

** Please use non PC-100 SDRAM module or EDO DIMM module

JP13 Setting

Mode	JP13	
Dual Voltage Mode(Vcore ≠Vi/o)	1-2 closed	4-5 closed

G-6 AMD-K6-2 300, 350, 400MHz

SW2(2.2V)

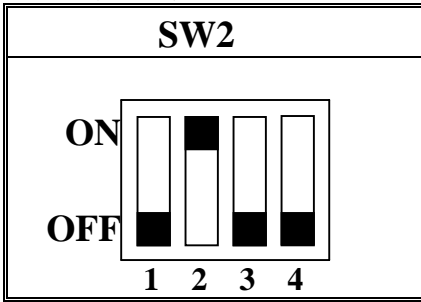

INTERNAL CPU CLOCK	SW1	Ext.x Frq.
300MHz		100 x 3.0
350MHz		100 x 3.5
400MHz		100 x 4.0

JP5, JP6 & JP7 Setting

CPU host clock/DRAM/PCI clock	JP 5	JP 6	JP 7
100MHz/100MHz/33MHz*	Pin 1-2	Pin 2-3	Pin1-2
100MHz/66MHz/33MHz**	Pin 2-3	Pin 1-2	Pin 1-2

* Please use for PC-100 SDRAM module

** Please use non PC-100 SDRAM module or EDO DIMM module

JP13 Setting

Mode	JP13	
Dual Voltage Mode(Vcore ≠Vi/o)	1-2 closed	4-5 closed

G-7. AMD-K6-III 400MHz, AMD-K6-2, K6-III 450MHz

SW2(2.4V)

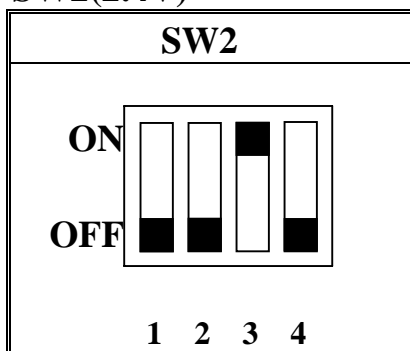

INTERNAL CPU CLOCK	SW1	Ext.x Frq.
400MHz	<p>ON</p> <p>OFF</p> <p>1 2 3 4 5 6</p>	100 x 4.0
450MHz	<p>ON</p> <p>OFF</p> <p>1 2 3 4 5 6</p>	100 x 4.5

The settings of JP5, JP6 and JP7 are depending on the CPU host clock. Before you do the following CPU settings, please set JP5, JP6 and JP7 to “Pin1-2, Pin2-3 and Pin1-2” position for PC-100 SDRAM module or set JP5, JP6 and JP7 to “Pin2-3, Pin1-2 and Pin1-2” position for non PC-100 SDRAM module or EDO DIMM module.

CPU host clock/DRAM/PCI clock	JP 5	JP 6	JP 7
100MHz/100MHz/33MHz*	Pin 1-2	Pin 2-3	Pin1-2
100MHz/66MHz/33MHz**	Pin 2-3	Pin 1-2	Pin 1-2

* Please use for PC-100 SDRAM module

** Please use non PC-100 SDRAM module or EDO DIMM module

JP13 Setting

Mode	JP13	
Dual Voltage Mode($V_{core} \neq V_{i/o}$)**	1-2 closed	4-5 closed

H. IDT Win Chip 2

SW2(3.5V)

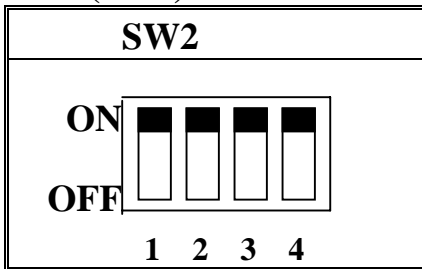

JP13 Setting

Mode	JP13	
Single Voltage Mode($V_{core} = V_{i/o}$)*	2-3 closed	5-6 closed

The settings of JP5, JP6 and JP7 are depending on the CPU host clock. Before you do the following CPU settings, please set JP5, JP6 and JP7 to “Pin1-2, Pin2-3 and Pin2-3” position.

CPU host clock/DRAM/PCI clock	JP 5	JP 6	JP 7
66MHz/66MHz/33MHz	Pin 1-2	Pin 2-3	Pin 2-3

IDT Win Chip 2 200, 233MHz

INTERNAL CPU CLOCK	SW1	Ext.x Frq.
200MHz	ON OFF	66 x 3.0
233MHz	ON OFF	66 x 3.5

IDT Win Chip 2 225MHz

INTERNAL CPU CLOCK	SW1	Ext.x Frq.
225MHz	ON OFF	75 x 3.0

SW2(3.5V)



JP13 Setting

Mode	JP13	
Single Voltage Mode($V_{core} = V_{i/o}$)*	2-3 closed	5-6 closed

The settings of JP5, JP6 and JP7 are depending on the CPU host clock. Before you do the following CPU settings, please set JP5, JP6 and JP7 to “Pin1-2, Pin2-3 and Pin1-2” position for PC-100 SDRAM module or set JP5, JP6 and JP7 to “Pin2-3, Pin1-2 and Pin1-2” position for non PC-100 SDRAM module or EDO DIMM module.

CPU host clock/DRAM/PCI clock	JP 5	JP 6	JP 7
100MHz/100MHz/33MHz*	Pin 1-2	Pin 2-3	Pin1-2
100MHz/66MHz/33MHz**	Pin 2-3	Pin 1-2	Pin 1-2

* Please use for PC-100 SDRAM module

** Please use non PC-100 SDRAM module or EDO DIMM module

IDT Win Chip 2 300MHz

INTERNAL CPU CLOCK	SW1	Ext.x Frq.																					
300MHz	<table border="1"> <thead> <tr> <td>ON</td> <td>□</td> <td>□</td> <td>■</td> <td>■</td> <td>■</td> <td>□</td> </tr> <tr> <td>OFF</td> <td>■</td> <td>■</td> <td>□</td> <td>□</td> <td>□</td> <td>■</td> </tr> <tr> <td></td> <td>1</td> <td>2</td> <td>3</td> <td>4</td> <td>5</td> <td>6</td> </tr> </thead></table>	ON	□	□	■	■	■	□	OFF	■	■	□	□	□	■		1	2	3	4	5	6	100 x 2.5
ON	□	□	■	■	■	□																	
OFF	■	■	□	□	□	■																	
	1	2	3	4	5	6																	

2-3 SYSTEM MEMORY INSTALLATION

The ATC-5220 provides three 168-pin DIMM sockets for system memory expansion from 8MB to 768MB. These three DIMMs are arranged to three banks, please refer to page A. Each bank provides 64-bit wide data path.

※ Samples of System Memory Combinations Options ※

BANK0 DIMM 1	BANK1 DIMM 2	BANK2 DIMM 3	Total Memory DIMM 1-3
	16MBx1	16MBx1	32MB
16MBx1	-	16MBx1	32MB
32MBx1	-	-	32MB
-	32MBx1	-	32MB
-	-	32MBx1	32MB
8MBx1	16MBx1	16MBx1	40MB
32MBx1	32MBx1	-	64MB
-	32MBx1	32MBx1	64MB
64MBx1	-	-	64MB
-	64MBx1	-	64MB
:	:	:	:
-	64MBx1	64MBx1	128MB
128MBx1	-	-	128MB
-	128MBx1	-	128MB
-	-	128MBx1	128MB
128MBx1	128MBx1	-	256MB
128MBx1	-	128MBx1	256MB
-	128MBx1	128MBx1	256MB
256MBx1	256MBx1	-	512MB
256MBx1	-	256MBx1	512MB
-	256MBx1	256MBx1	512MB
256MBx1	256MBx1	256MBx1	768MB

2-4 CONNECTORS DESCRIPTION

The locations of following connectors are indicated in page A. When you plug wires into the following connector of CONN1, you should have the pin 1 edge of the wires align with the pin 1 end of the connector.

CONN1 : speaker, keyboard lock, reset, SMI, turbo LED, and IDE LED connectors.

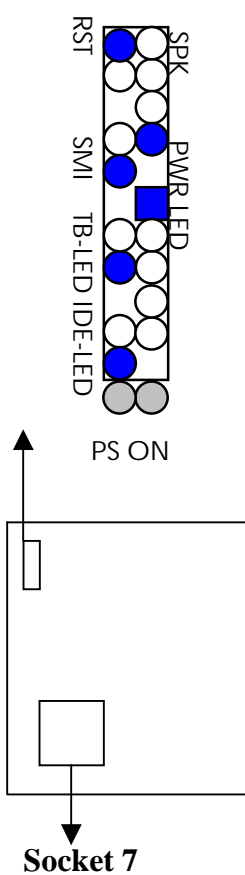

SPK : speaker

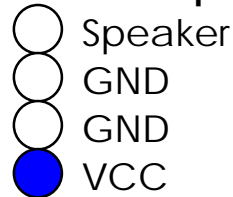

Power LED connector

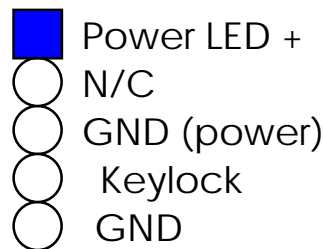

RST : Reset connector

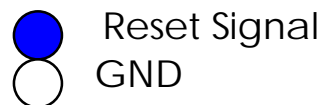

SMI : SMI lead

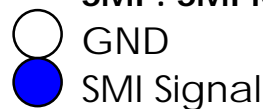

TB-LED : Turbo LED indicator, LED on when system runs higher speed.



IDE-LED : IDE devices indicator LED

connector. IDE-LED stays ON indicates

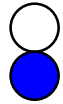

LED signal on-board IDE devices in operation.

The

+5V

red wire of the HDD connector must

be

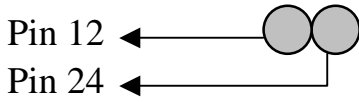

PS_ON : Power Button

Pin 12 : PS_ON

Pin 24 : +5VSB

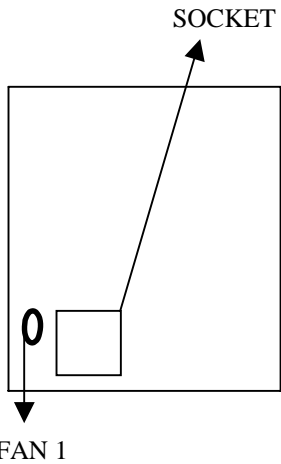

FAN1 : CPU cooling fan connector. Wire with +12V voltage (most likely red wire) must be plugged into pin2, and GROUND wires (most likely black wire) must be plugged into pin1. Please confirm the wire color re-presentation with your supplier.

CAUTION: Plug the wire into wrong connector will DAMAGE fan and mainboard.

- 1 **GND**
- 2 **+12V**
- 3

IR1 : Infrared module connector.

- 1 +5V
- 2 FIRRX
- 3 IRRX
- 4 GND
- 5 IRTX

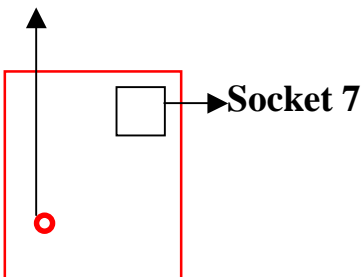

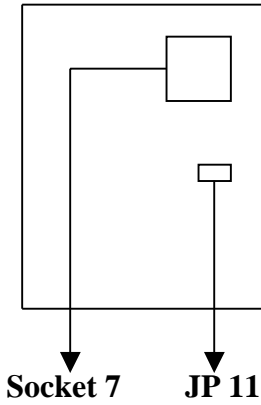

JP 11
 Pin 1-2 : Interlave mode
 Pin 2-3 : Linear Burst

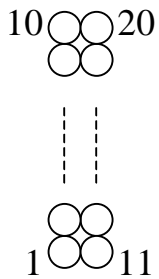

PW1 : ATX mode +3.3/5/12V power supply connector.

1	3.3V	6	+5V	11	3.3V	16	GND
2	3.3V	7	GND	12	-12V	17	GND
3	GND	8	PWRGD	13	GND	18	-5V
4	+5V	9	5VSB	14*	PS_ON	19	+5V
5	GND	10	+12V	15	GND	20	+5V

* PS_ON : Soft-Off power control

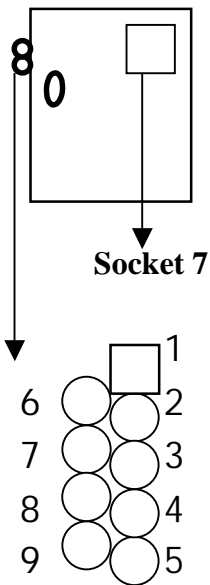

COM1/COM2 : these two connectors are used to connect serial port cables.

pin	Signal name
1	NDCDA/B
2	NSINA/B
3	NSOUTA/B
4	NDTRA/B
5	GND
6	NDSRA/B
7	NRTSA/B
8	NCTSA/B
9	NRIA/B

A is COM1, B is COM2

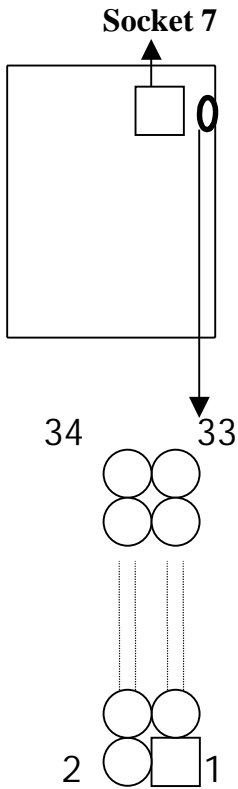

FDC1 : this connector is used to connect the floppy drive through a cable.

pin	signal	pin	signal
2	RWC-	20	STEP-
4	Reserved	22	Write Data
6	FDEDIN	24	Write Gate
8	Index-	26	Track 00-
10	Motor EnableA-	28	Write Protect-
12	Drive Sele.B-	30	Read Data-
14	Drive Sele.A-	32	Side 1 Sele.-
16	Motor EnableB-	34	DisketteChange
18	DIR-		
All of odd pins are ground			

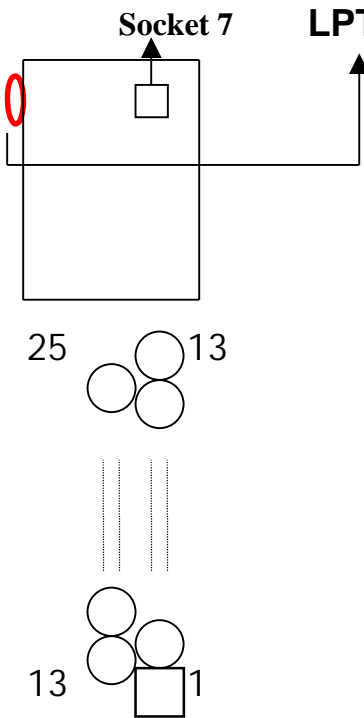

LPT : this connector is used to connect parallel port cable.

Pin	Signal	pin	Signal
1	STROBE-	10	ACK-
2	Data Bit 0	11	BUSY
3	Data Bit 1	12	PE
4	Data Bit 2	13	SLCT
5	Data Bit 3	14	Auto Feed-
6	Data Bit 4	15	ERROR-
7	Data Bit 5	16	INIT-
8	Data Bit 6	17	SLCT IN-
9	Data Bit 7		
Pin18 -- pin25 are GND			

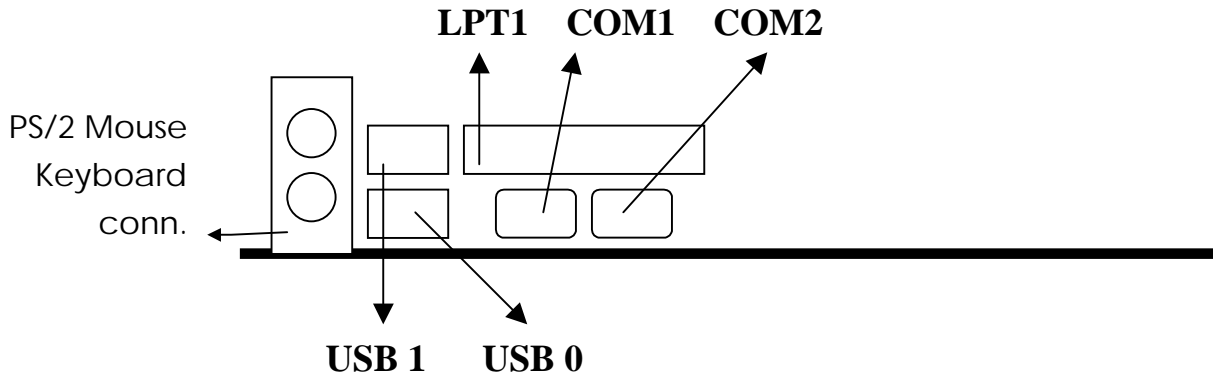

IDE1/IDE2 : these two connectors are used to connect IDE devices through IDE cables, a total of 4 devices can be connected.

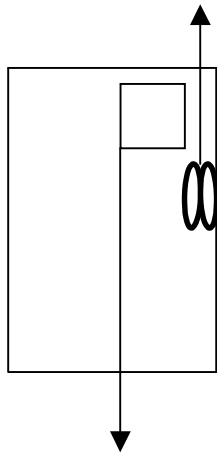
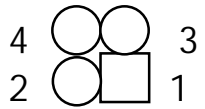
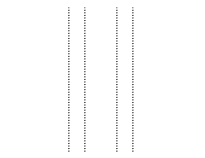
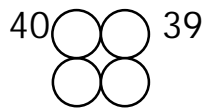

Socket 7

pin	signal	Pin	Signal
1	Reset IDE	21	DDRQ0(1)
2	GND	22	GND
3	Host Data 7	23	I/O Write-
4	Host Data 8	24	GND
5	Host Data 6	25	I/O Read-
6	Host Data 9	26	GND
7	Host Data 5	27	IORDY
8	Host Data 10	28	N/C
9	Host Data 4	29	DDAK0- (1-)
10	Host Data 11	30	GND
11	Host Data 3	31	IRQ14*
12	Host Data 12	32	IOCS16-
13	Host Data 2	33	Addr 1
14	Host Data 13	34	N/C
15	Host Data 1	35	Addr 0
16	Host Data 14	36	Addr 2
17	Host Data 0	37	ChipSele.1P-
18	Host Data 15	38	ChipSele.3P-
19	GND	39	Activity
20	Key	40	GND

* IDE1 : pin31 is IRQ14;

IDE2 : pin31 is IRQ15 or MIRQ0

2-5 IDE DRIVER INSTALLATION

The IDE driver installation procedures are in the following :

Setup from Windows 95/98 :

1. Starting Windows 95/98.
2. Put All-In-One CD into your CD-ROM drive.
3. In “My Computer” Windows, double clicking “VIA” icon.
4. Choose “IDE driver”.
5. Follow the screen instructions to complete the installation.

Setup from WinNT :

1. Starting WinNT.
2. Put All-In-One CD into your CD-ROM drive.
3. Choose “VIA MVP3 Integrated Installation”.
4. Choose “IDE driver”.
5. Follow the screen instructions to complete the installation.
6. In “control panel” Windows, click “SCSI Adapters” twice.
7. In “SCSI Adapters” Windows, choose “Drivers”.
8. Choose “Add”.
9. In manufacturers, select “additional models”, then in SCSI adapter, select “VIA bus master IDE drivers”, then choose “OK”.
10. Restart your computer.

2-6 VIA MVP3 AGP VGA Driver Installation

1. Put All-In-One CD into your CD-ROM drive.
2. In “My computer” Windows, choose VxD driver.
3. Follow the screen instructions to complete the installation.

Remark :

Please install two VIA utilities from our CD, “ VIA Routing Utility “ & “ VIA MVP3 ACPI Compliant utility ”, when you install Windows95/98 on your system, in order to get best compatibility.

CHAPTER 3 Award BIOS SETUP

Award BIOS manufacturer provides access to the system BIOS through the hardware and software on each ATC-5220 mainboard. The hardware consists of a Flash ROM and the software is a group of programs that are installed in the ROMBIOS along with all the other data the BIOS must contain.

The ATC-5220 mainboard will require special driver supplied by the manufacturer to update the BIOS SETUP program. It is a good idea to read the next page for details for update BIOS driver installation or you can ask your system dealer to do it for you.

When the driver has been successfully updated, it is very important to contact your system dealer to change the CMOS settings for your computer. The CMOS settings are shown in the following pages.

NOTE : To clear CMOS you should unplug the power cord, then set 2-3 to clear, put it back to normal position and plug the power cord again.

	JP8
Normal	1-2
Clear	2-3

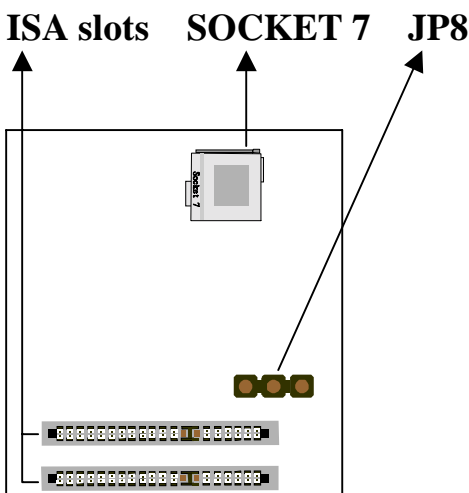
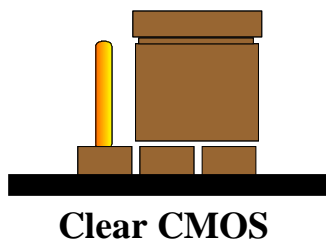
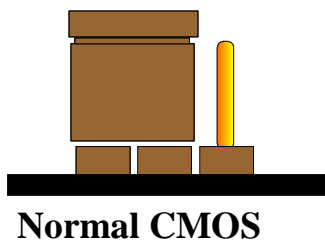

3-1 UPDATE BIOS PROCEDURE

If the BIOS needs to be updated, you can get a diskette with the updated BIOS driver from your system supplier or from your All-In-One CD(in "flash" directory). The BIOS updated driver includes :

"awdfash.exe" -- BIOS update utility program
"awdfash.doc"
"(update BIOS filename with version number).bin"

The update procedure is in the following:

1. Boot the system to DOS mode in a normal manner.
2. Insert the updated diskette to drive A (or B), or put All-In-One CD into your CD-ROM drive.
3. Change working directory to floppy drive, A or B, or change working directory to your CD-ROM drive, D or E, which contains the update BIOS driver. -- Type "a:\\" or "b:\\"", "ENTER" or "d:\\" or "e:\\"", "ENTER".
4. Run the BIOS update utility -- Type "cd flash", then press "ENTER" key. After that , type "awdfash", then press "ENTER" key.
5. Type "(update BIOS file name with version number).bin", ENTER.
6. If you do not want to save the old BIOS Type "N" when the screen displays the message : " Do you want to save BIOS (Y/N) ?".
7. Type "Y" when the screen shows the message : " Are you sure to program (Y/N) ?".
8. Follow instructions displayed on the screen. DO NOT remove the update BIOS diskette from the floppy drive nor turn the system power off until the BIOS update is completed.
9. Turn the power off. Clear the data in CMOS according to the procedure described in the previous page.
10. Turn the system power on and test that your system is working properly.

3-2 Award SYSTEM BIOS CONFIGURATION SETUP

The following pages explain how to set up the system configuration (CMOS) under the Award BIOS. The SETUP program is stored in the Read-Only-Memory (ROM) on the mainboard. To do the SETUP procedure, press the key when the system is booting up. The following main menu will appear. Please select "STANDARD CMOS SETUP" to enter the next screen.

ROM PCI/ISA BIOS (ATC-5220)
CMOS SETUP UTILITY
AWARD SOFTWARE, INC.

STANDARD CMOS SETUP	INTEGRATED PERIPHERALS
BIOS FEATURES SETUP	SUPERVISOR PASSWORD
CHIPSET FEATURES SETUP	USER PASSWORD
POWER MANAGEMENT SETUP	IDE HDD AUTO DETECTION
PNP/PCI CONFIGURATION	SAVE & EXIT SETUP
LOAD BIOS DEFAULTS	EXIT WITHOUT SAVING
LOAD SETUP DEFAULTS	
ESC: Quit	↓→←:Select Item
F10: Save & Exit Setup	(Shift) F2 : Change Color
Time, Date, Hard Disk Type	

The section on the bottom of the main menu explains how to control this screen. The other section displays the items highlighted in the list.

This screen records some basic hardware information, and sets the system clock and error handling. These records can be lost or corrupted if the on-board battery has failed or is weak.

ROM PCI/ISA BIOS (ATC-5220)
 CMOS SETUP UTILITY
 AWARD SOFTWARE, INC.

STANDARD CMOS SETUP	INTEGRATED PERIPHERALS
BIOS FEATURES SETUP	SUPERVISOR PASSWORD
CHIPSET FEATURES SETUP	USER PASSWORD
POWER MANAGEMENT SETUP	IDE HDD AUTO DETECTION
PNP/PCI CONFIGURATION	SAVE & EXIT SETUP
LOAD BIOS DEFAULTS	EXIT WITHOUT SAVING
LOAD SETUP DEFAULTS	
ESC: Quit	↑↓→←:Select Item
F10: Save & Exit Setup	(Shift) F2 : Change Color
Time, Date, Hard Disk Type	

ROM PCI/ISA BIOS (ATC-5220)
 STANDARD CMOS SETUP
 AWARD SOFTWARE, INC.

Date (mm:dd:yy) : Wed, June 05 1998										
Time(hh:mm:ss) : 13 : 37 : 14										
HARD DISKS	TYPE	SIZE	CYLS	HEAD	PRECOMP	LANDZ	SECTOR	MODE		
Primary Master	: Auto	0	0	0	0	0	0	Auto		
Primary Slave	: Auto	0	0	0	0	0	0	Auto		
Secondary Master	: Auto	0	0	0	0	0	0	Auto		
Secondary Slave	: Auto	0	0	0	0	0	0	Auto		
Drive A : 1.44M, 3.5 in.										
Drive B : None										
Floppy 3 Mode Support : Disabled										
Video : EGA/VGA										
Halt On: All Errors										
					Base Memory	:	640K			
					Extended memory	:	7168K			
					Other Memory	:	384K			

					Total Memory	:	8192K			
ESC	:	Quit	↑↓→←:Select Item				PU/PD/+/- : Modify			
F1	:	Help	(Shift) F2 : Change Color							

Date

The date format is <day>, <date><month><year>. Press<F3> to show the calendar.

Day	The day, from Sun to Sat, determined by the BIOS and is display-only
Date	The date, from 1 to 31
Month	The month, Jan. through Dec.
Year	The year, from 1900 to 2099

Time

The time format is <hour><minute><second>. The time is calculated based on the 24-hour military-time clock. For example, 1p.m. is 13:00:00.

- Primary Master**
- Primary Slave**
- Secondary Master**
- Secondary Slave**

These categories identify the types of the 2 channels that have been installed in the computer. There are 45 predefined types and 4 user definable types are for Enhanced IDE BIOS. Type 1 to 45 are predefined. Type **'user'** is user-definable. Press PgUp/PgDn to select a numbered hard disk type or type the number and press<Enter>. If you select **'Auto'**, the BIOS will auto-detect the HDD & CD-ROM Drive at the POST stage and show the IDE for HDD & CD-ROM Drive. If you select **'user'**, you will need to know the information listed below. Enter the information directly from the keyboard and press <Enter>. This information should be from your hard disk vender or dealer. If the controller of the HDD interface is ESDI, the selection shall be **'Type 1'**; if SCSI, the selection shall be **'None'**. If no device is installed select **'NONE'** and press <Enter>.

Type	drive type
SIZE	Automatically adjusts
CYLS	number of cylinders
HEAD	number of heads
PRECOMP	write precom
LANDZ	landing zone
SECTOR	number of sectors
MODE	mode type

Drive A
Drive B

This category identifies the types of floppy disk drive A or drive B that have been installed in the computer.

None	No floppy drive installed
360K, 5.25 in	5.25" PC-type 360KB capacity
1.2M, 5.25 in	5.25" AT-type 1.2MB capacity
720K, 3.5 in	3.5" double-side 720KB capacity
1.44M, 3.5 in	3.5" double-side 1.44MB capacity
2.88M, 3.5 in	3.5" double-side 2.88MB capacity

Floppy 3 Mode
Support

This is the Japanese standard floppy drive. This standard stores 1.2MB in a 3.5" diskette

Video

This category selects the type of video adapter used for the primary system monitor. Although secondary monitors are supported, you do not have to select the type in Setup.

EGA/VGA	Enhanced Graphics Adapter/Video Graphics Array. For EGA, VGA, SEGA, SVGA or PGA monitor adapters
CGA 40	Color Graphics Adapters, power up in 40 column mode
CGA 80	Color Graphics Adapters, power up in 80 column mode
MONO	Monochrome adapter, includes high resolution monochrome adapters

Halt On

This category determines whether the computer will stop if an error is detected during power up.

No errors	The system boot will not be stopped for any error that may be detected
All errors	When the BIOS detects a non-fatal error the system will be stopped and you will be prompted
All, But Keyboard	The system boot will not stop for a keyboard error, it will stop for all other errors
All, But Diskette	The system boot will not stop for a disk error, it will stop for all other errors
All, But Disk/Key	The system boot will not stop for a disk or keyboard error, it will stop for all other errors

Memory

This category is display-only which is determined by POST (Power On Self Test) of the BIOS.

Base Memory The POST will determine the amount of base (or conventional) memory installed in the system. The value of the base memory is typically 512K or 640K based on the memory installed on the motherboard.

Extended Memory How much extended memory is present during the POST. This is the amount of memory located above 1MB in the CPU's memory address map.

Other Memory This refers to the memory located in the 640K to 1024K address space. This is memory that can be used for different applications. DOS users this area to load device drivers in an effort to keep as much base memory free for application programs. The BIOS is the most frequent user of this RAM area since this is where it shadows RAM.

This screen is a list of system configuration options. Some of them are defaults required by the mainboard's design, others depend on the features of your system.

ROM PCI/ISA BIOS (ATC-5220)

CMOS SETUP UTILITY

AWARD SOFTWARE, INC.

STANDARD CMOS SETUP	INTEGRATED PERIPHERALS
BIOS FEATURES SETUP	SUPERVISOR PASSWORD
CHIPSET FEATURES SETUP	USER PASSWORD
POWER MANAGEMENT SETUP	IDE HDD AUTO DETECTION
PNP/PCI CONFIGURATION	SAVE & EXIT SETUP
LOAD BIOS DEFAULTS	EXIT WITHOUT SAVING
LOAD SETUP DEFAULTS	
ESC: Quit	↑↓→←:Select Item
F10: Save & Exit Setup	(Shift) F2 : Change Color
Virus, Protection, Boot Sequence	

ROM PCI/ISA BIOS (ATC-5220)

BIOS FEATURES SETUP

AWARD SOFTWARE, INC.

Virus Warning	: Disabled	Video BIOS Shadow	: Enabled
CPU Internal Cache	: Enabled	C8000-CBFFF Shadow	: Disabled
External Cache	: Enabled	CC000-CFFFF Shadow	: Disabled
Quick Power On Self Test	: Enabled	D0000-D3FFF Shadow	: Disabled
Boot Sequence	: A,C,SCSI	D4000-D7FFF Shadow	: Disabled
Swap Floppy Drive	: Disabled	D8000-DBFFF Shadow	: Disabled
Boot Up Floppy Seek	: Enabled	DC000-DFFFF Shadow	: Disabled
Boot Up NumLock Status	: On		
Gate A20 Option	: Fast		
Memory Parity/ECC Check	: Enabled		
Typematic Rate Setting	: Disabled		
Typematic Rate(Chars/Sec)	: 6		
Typematic Delay(Msec)	: 250	Esc : Quit	↑↓→←:Select Item
Security Option	: Setup	F1 : Help	PU/PD/+/- : Modify
PCI/VGA Palette Snoop	: Disabled	F5 : Old Values (SHIFT)	F2 : Color
OS Select for DRAM>64MB	: Non-OS2	F6 : Load BIOS Defaults	
Report No FDD For Win95	: No	F7 : Load Setup Defaults	

Virus Warning

When this item is enabled, the Award BIOS will monitor the boot sector and partition table of the hard disk drive for any attempt at modification. If an attempt is made, the BIOS will halt the system and the following error message will appear. Afterwards, if necessary, you will be able to run an antivirus program to locate and remove the problem before any damage is done.

<p>! WARNING !</p> <p>Disk boot sector is to be modified Type 'Y' to accept write or 'N' to abort write Award Software, Inc.</p>

Enabled	Activates automatically when the system boots up, if anything attempts to access the boot sector or hard disk partition table will cause a warning message to appear.
Disabled	No warning message will appear when anything attempts to access the boot sector or hard disk partition table.

Many disk diagnostic programs which attempt to access the boot sector table can cause the above warning message. If you will be running such a program, we recommend that you first disable Virus Protection beforehand.

CPU

Internal Cache

External Cache

These two categories speed up memory access. However, it depends on CPU/chipset design. The default value is 'enabled'.

Quick Power On Self Test

This category speeds up Power On Self Test after you power up the computer. If you set Enabled, BIOS will shorten or skip some checked items during POST.

Boot Sequence

This category determines which drive is to search first for the Disk Operating System (i.e., DOS).

A, C, SCSI	System will first search for floppy disk drive then hard disk drive, and the next is SCSI device.
C, A, SCSI	System will first search for hard disk drive then floppy disk drive, and the next is SCSI device.
C, CDROM, A	System will first search for hard disk drive then CDROM drive, and the next is floppy disk drive.
CDROM, C, A	System will first search for CDROM drive then hard disk drive, and the next is floppy disk drive.
D, A, SCSI	System will first search for secondary hard disk drive then floppy disk drive, and the next is SCSI device.
E, A, SCSI	System will first search for third hard disk drive then floppy disk drive, and the next is SCSI device.
F, A, SCSI	System will first search for fourth hard disk drive then floppy disk drive, and the next is SCSI device.
SCSI, A, C	System will first search for SCSI device then floppy disk drive, and the next is hard disk drive.
SCSI, C, A	System will first search for SCSI device then hard disk drive, and the next is floppy disk drive.
C only	System will search for hard disk drive only.
LS/ZIP, C	System will first search for LS120 or IOMEGA (ZIP) drive, and the next is hard disk drive.

C is primary master; D is primary slave;
E is secondary master, F is secondary slave

Swap Floppy Drive

This item allows you to determine whether to enable the swap floppy drive or not.

The choice : Enabled/ Disabled

Boot Up Floppy Seek

During POST, the BIOS will determine if the floppy disk drive installed is 40 tracks (360K) or 80 tracks (720K, 1.2M, 1.44M)

Enabled	BIOS searches for floppy disk drive to determine if it is 40 or 80 tracks
Disabled	BIOS will not search for the type of floppy disk drive by track number

Boot Up
NumLock Status

This allows you to determine the default state of the numeric keypad. By default, the system boots up with NumLock on.

On	Keypad is numeric keys
Off	Keypad is arrow keys

Gate A20
Option

This entry allows you to select how the gate A20 is handled. The gate A20 is a device used to address memory above 1 MB. Initially, the gate A20 was handled via a pin on the keyboard. Today, while keyboards still provide this support, it is more common, and much faster, for the system chipset to provide support for gate A20.
Normal is keyboard; Fast is chipset.

**Memory Parity/
ECC Check**

Select parity, ECC, or Disabled, depending on the type of DRAM installed in your system.
The choice : ECC, Parity, Disabled

Typematic Rate
Setting

This determines if the typematic rate is to be used. When disabled, continually holding down a key on your keyboard will generate only one key instance. In other words, the BIOS will only report that the key is down. When the typematic rate is enabled, the BIOS will report as before, but it will then wait a moment, and, if the key is still down, it will begin the report that the key has been depressed repeatedly. For example, you would use such a feature to accelerate cursor movements with the arrow keys.
The choice : Enabled/Disabled

Typematic Rate
(Chars/Sec)

When the typematic rate is enabled, this section allows you select the rate at which the keys are repeated.

6	6 characters per second
8	8 characters per second
10	10 characters per second
12	12 characters per second
15	15 characters per second
20	20 characters per second
24	24 characters per second
30	30 characters per second

Typematic Delay
(Msec)

When the typematic rate is enabled, this section allows you select the delay between when the key was first depressed and when the acceleration begins.

250	250 msec
500	500 msec
750	750 msec
1000	1000 msec

Security Option

This category allows you to limit access to the system and Setup, or just to Setup.

System	The system will not boot and access to Setup will be denied if the correct password is not entered at the prompt
Setup	The system will boot, but access to Setup will be denied if the correct password is not entered at the prompt

To disable security, select PASSWORD SETTING at Main Menu and then you will be asked to enter password. Do not type anything and just press <Enter>, it will disable security. Once the security is disabled, the system will boot and you can enter Setup freely.

PCI/VGA Palette
Snoop

It determines whether the MPEG ISA/VESA VGA cards can work with PCI/VGA or not.

Enabled	When PCI/VGA working with MPEG ISA/VESA VGA Card
Disabled	When PCI/VGA not working with MPEG ISA/VESA VGA Card

OS Select for
DRAM > 64MB

This item allows you to access the memory that is over 64MB in OS/2.

The choice : Non-OS2 or OS2

Report No FDD
For WIN 95

Set this item to Yes BIOS will report FDD to Win95.
If in standard CMOS setup, set Drive A to none, and set this item to yes. Inside Win95, My Computer and File manager Disk(A:) will show Removable Disk (A:).

Video BIOS
Shadow

Determines whether video BIOS will be copied to RAM. However it is optional depending on chipset design. Video Shadow will increase the video speed.
The choice : Enabled/Disabled

C8000 - CBFFF
Shadow
DC000 - DFFFF
Shadow

These categories determine whether option ROMs will be copied to RAM. An example of such option ROM would be the support of onboard SCSI.
The choice : Enabled/Disabled

This screen controls the setting for the chipset on the mainboard.

ROM PCI/ISA BIOS (ATC-5220)

CMOS SETUP UTILITY

AWARD SOFTWARE, INC.

STANDARD CMOS SETUP	INTEGRATED PERIPHERALS
BIOS FEATURES SETUP	SUPERVISOR PASSWORD
CHIPSET FEATURES SETUP	USER PASSWORD
POWER MANAGEMENT SETUP	IDE HDD AUTO DETECTION
PNP/PCI CONFIGURATION	SAVE & EXIT SETUP
LOAD BIOS DEFAULTS	EXIT WITHOUT SAVING
LOAD SETUP DEFAULTS	
ESC: Quit	↑↓→←:Select Item
F10: Save & Exit Setup	(Shift) F2 : Change Color
AT Clock, DRAM Timings,	

ROM PCI/ISA BIOS (ATC-5220)

CHIPSET FEATURES SETUP

AWARD SOFTWARE, INC.

Bank 0/1 DRAM Timing : FP/EDO 60ns	OnChip USB : Disabled
Bank 2/3 DRAM Timing : FP/EDO 60ns	Auto Detect DIMM/PCI Clk : Enabled
Bank 4/5 DRAM Timing : FP/EDO 60ns	Spread Spectrum Modulatd : Disabled
SRAM Cycle Length : 3	
DRAM Read Pipeline : Disabled	
Sustained 3T Write : Enabled	
Cache Rd+CPU Wt Pipeline : Disabled	
Cache Timing : Fast	
Video BIOS Cacheable : Disabled	
System BIOS Cacheable : Disabled	
Memory Hole At 15Mb Addr. : Disabled	
AGP Aperture Size (MB) : 128MB	
Esc: Quit	:Select Item
F1 : Help	PU/PD/+/-:Modify
F5 : Old Values	(Shift)F2 :Color
F6 :Load BIOS Defaults	
F7 : Load Setup Defaults	

**Bank 0/1/2/3/4/5
DRAM Timing**

The DRAM speed is controlled by the DRAM timing registers. The programmed into this register are depend on the system design. Slower rates may be required in certain system designs to support loose layouts or slower memory. i.e. 60ns; 70ns

**SDRAM Cycle
Length**

You should select CAS latency time in HCLKS of 2/2 or 3/3. The system board designer should set the values in this field, depending on the DRAM installed. Do not change the values in this field unless you change specifications of the installed DRAM or the installed CPU..

The choice : 2, .3

**DRAM Read
Pipeline**

Enable/Disable DRAM Read Pipeline Cycle.

**Sustained 3T
Write**

Enabled : set cache to write back mode.

Disabled : set cache to write through mode.

**Cache Rd+CPU
Wt Pipeline**

Enable/Disable Cache Read Write cycle.

Cache Timing

Fastest : better system performance will occur.

**Video BIOS
Cacheable**

Select Enabled allows caching of the video BIOS ROM at F0000h-FFFFFh, resulting in better system performance.

However, if any program writes to this memory area, a system error may result.

**System BIOS
Cacheable**

Select Enabled allows caching of the system BIOS ROM at F0000h-FFFFFh, resulting in better system performance.

However, if any program writes to this memory area, a system error may result.

**Memory Hole At
15Mb Addr.**

In order to improve performance, certain space in memory can be reserved for ISA cards. This memory must be mapped into the memory below 16MB.

**AGP Aperture
Size (MB)**

Select the size of the AGP aperture. The aperture is a portion of the PCI memory address range dedicated for graphics memory address space. Host cycle that hit the aperture range are forwarded to the AGP without any translation. See www.agpforum.org for AGP information.

Onchip USB

Enable/Disable USB.

**Auto Detect
DIMM/PCI CLK**

If this item is enabled, the unused DIMM and PCI slot clock will be disabled. If this item is disabled the unused DIMM and PCI slot will still get the active clock signal.

**Spread Spectrum
Modulated**

Enable / Disable this item the BIOS will Enable / Disable the clock generator spread spectrum .

This screen controls the 'green' features of this mainboard.

ROM PCI/ISA BIOS (ATC-5220)

CMOS SETUP UTILITY

AWARD SOFTWARE, INC.

STANDARD CMOS SETUP	INTEGRATED PERIPHERALS
BIOS FEATURES SETUP	SUPERVISOR PASSWORD
CHIPSET FEATURES SETUP	USER PASSWORD
POWER MANAGEMENT SETUP	IDE HDD AUTO DETECTION
PNP/PCI CONFIGURATION	SAVE & EXIT SETUP
LOAD BIOS DEFAULTS	EXIT WITHOUT SAVING
LOAD SETUP DEFAULTS	
ESC: Quit	↑↓→←:Select Item
F10: Save & Exit Setup	(Shift) F2 : Change Color
Sleep Timer, Suspend Timer,	

ROM PCI/ISA BIOS (ATC-5220)

POWER MANAGEMENT SETUP

AWARD SOFTWARE, INC.

Power Management : User Defined	Primary INTR : ON
PM Control by APM : Yes	IRQ3 (COM2) : Primary
Video Off Option : Suspend ->OFF	IRQ4 (COM1) : Primary
Video Off Method : DPMS	IRQ5 (LPT 2) : Primary
Modem Use IRQ : 3	IRQ6 (Floppy Disk) : Primary
Soft-Off by PWRBTN : Instant-Off	IRQ7 (LPT 1) : Primary
** PM Timers **	IRQ8 (RTC Alarm) : Disabled
HDD Power Down : Disabled	IRQ9 (IRQ2 Redir) : Primary
Doze Mode : Disabled	IRQ10 (Reserved) : Primary
Suspend Mode : Disabled	IRQ11 (Reserved) : Primary
** PM Events **	IRQ12 (PS/2 Mouse) : Primary
VGA : OFF	IRQ13 (Coprocesor) : Disabled
LPT & COM : LPT/COM	IRQ14 (Hard Disk) : Primary
HDD & FDD : ON	IRQ15 (Reserved) : Disabled
DMA/master : OFF	Esc: Quit ↑↓→← :Select Item
Modem Ring Resume : Disabled	F1 : Help PU/PD/+/- : Modify
RTC Alarm Resume : Disabled	F5 : Old Values (Shift) F2: Color
	F6 : Load BIOS Defaults
	F7 : Load Setup Defaults

Power Management

This category allows you to select the type (or degree) of power saving and is directly related to the following modes : **Doze; Standby; Suspend; HDD Power Down.**

Min. Power Saving	Minimum power management. Doze =1hr.; Standby=1hr.; Suspend=1hr.; HDD Power Down=15min
Max. Power Saving	Maximum power management only available for SL CPU. Doze=1 min.; Standby=1 min.;Suspend=1 min.;HDD Power Down=1min
User Defined	Allows you to set each mode individually. When not disabled, each of the ranges are from 1min. to 1hr. except for HDD Power Down which ranges from 1 to 15min. and disable

If you would like to use Software Power-off Control function, you cannot choose“ Disabled ”here, and should select “Yes” in PM Control by APM.

PM Control by APM

When enabled, an Advanced Power Management device will be activated to enhance the Max. Power Saving Mode and stop the CPU internal clock. If the Max. Power Saving is not enabled, this will be shown as NO.

Video Off Option

When enabled, this feature allows the VGA adapter to operate in a power saving mode.

Always On	Monitor will remain on during power saving modes.
Suspend	Monitor blanked when the systems enters the Suspend mode.
Susp, Stby	Monitor blanked when the system enters Suspend or Standby mode.
All Modes	Monitor blanked when the system enters any power saving mode.

Video Off
Method

This determines the manner in which the monitor is blanked.

V/H SYNC + Blank	This selection will cause the system to turn off the vertical and horizontal sync. ports and write blanks to the video buffer
Blank Screen	This option only writes blanks to the video buffer
DPMS	Initial display power management signaling

MODEM Use IRQ

This item determines the IRQ in which the MODEM can be used.

The choice : 3,4,5,7,9,10,11,NA.

Soft-Off by
PWR-BTTN

Instant-off : When push the power button, the system power will be off immediately. Delay 4 sec : when push the power button, it will enter suspend mode. We need to push the power button and hold for 4 seconds to turn off the power.

The Following 4 modes are Green PC power saving functions which are only user configurable when 'User Defined' power management has been selected.

HDD Power Down

When enabled and after the set time of system inactivity, the hard disk drive will be powered down while all other devices remain active.

Doze Mode

When enabled and after the set time of system inactivity, the CPU clock will run at slower speed while all other devices still operate at full speed.

Suspend Mode

When enabled and after the set time of system inactivity, all devices except the CPU will be shut off.

VGA/LPT & COM
HDD & FDD/
DMA/master

These are I/O events whose occurrence can prevent the system from entering a power saving mode or can awaken the system from such a mode. In effect, the system remains alert for anything which occurs on a device which is configured as on, even when the system is in a password down mode. When an I/O device wants to gain the attention of the operating system, it signals this by causing an IRQ(Interrupt ReQuest) to occur. When the operating system is ready to respond to the request, it interrupts itself and performs the service. When set to off, activity will neither prevent the system from going into a power management mode nor awaken it.

Modem Ring
Resume

Enabled : when system in suspend mode, it can be wake up by modem.
Disabled : it cannot be wake up by modem.

RTC Alarm
Resume

When enabled, two additional lines will added to the screen :
Date (of Month) Alarm; Time (hh:mm:ss) Alarm to let user set
The desired date and time. After power off, the system will
automatic power on at the specified date and time.

Primary INTR

It enables/disables the IRQ3 to IRQ15 PM events.

This screen configures the PCI Bus slots.

ROM PCI/ISA BIOS (ATC-5220)
 CMOS SETUP UTILITY
 AWARD SOFTWARE, INC.

STANDARD CMOS SETUP	INTEGRATED PERIPHERALS
BIOS FEATURES SETUP	SUPERVISOR PASSWORD
CHIPSET FEATURES SETUP	USER PASSWORD
POWER MANAGEMENT SETUP	IDE HDD AUTO DETECTION
PNP/PCI CONFIGURATION	SAVE & EXIT SETUP
LOAD BIOS DEFAULTS	EXIT WITHOUT SAVING
LOAD SETUP DEFAULTS	
ESC: Quit	↑↓→←:Select Item
F10: Save & Exit Setup	(Shift) F2 : Change Color
IRQ Settings, Latency Timers,	

ROM PCI/ISA BIOS (ATC-5220)
 PNP/PCI CONFIGURATION
 AWARD SOFTWARE, INC.

PNP OS Installed : No	CPU to PCI Write Buffer : Enabled
Resources Controlled by : Auto	PCI Dynamic Bursting : Disabled
Reset Configuration Data : Disabled	PCI Master 0 WS Write : Enabled
ACPI I/O Device Node : Enabled	PCI Delay Transaction : Disabled
	PCI Master Read Prefetch : Disabled
	PCI#2 Access #1 Retry : Disabled
	AGP Master 1 WS Write : Disabled
	AGP Master 1 WS Read : Disabled
	PCI IDE IRQ Map To : PCI-AUTO
	Primary IDE INT# : A
	Primary IDE INT# : B
	Assign IRQ For USB : Disabled
	Assign IRQ For VGA : Enabled
Esc: Quit ↑↓→← :Select Item	
F1 : Help PU/PD/+/- : Modify	
F5 : Old Values (Shift) F2: Color	
F6 : Load BIOS Defaults	
F7 : Load Setup Defaults	

<u>PNP OS Installed</u>	This item allows you to determine PnP OS or not. Choices are Yes or No.
<u>Resources Controlled By</u>	The Award Plug and Play BIOS has the capability to automatically configure all of the boot and Plug and Play compatible devices. However, this capability means absolutely nothing unless you are using a Plug and Play OS such as Windows 95. Choices are Auto and Manual.
<u>Reset Configuration Data</u>	This item allows you to determine whether to reset the configuration data or not.
<u>ACPI I/O Device Node</u>	Enable : reserve a node in memory for ACPI.
<u>CPU to PCI Write Buffer</u>	Enable/Disable CPU to PCI POST Write.
<u>PCI Dynamic Bursting</u>	Enable/Disable PCI burst operation.
<u>PCI Master 0 WS Write</u>	Enable : PCI Master 0 wait state mode. Disable : PCI Master 1 wait state mode.
<u>PCI Delay Transaction</u>	This chipset has an embedded 32-bit posted write buffer to support deadly transactions cycles. Select “enabled” to support compliance with PCI specification version 2.1. The choice : Enabled, disabled space
<u>PCI Master Read Prefetch</u>	Enable : always prefetch Disable : prefetch only if enhance command
<u>PCI#2 Access #1 Retry</u>	Disable : PCI#2 will be disconnected until access finished Enable : PCI#2 will be disconnected if max. retries are attempted without success.
<u>AGP Master 1 WS Write</u>	Enable/Disable AGP master one wait state write.

AGP Master
1 WS Read

Enable/Disable AGP master one wait state read.

PCI IDE IRQ
Map To
Primary IDE INT#
Secondary IDE
INT#

This allows you to configure your system to the type of IDE disk controller in use. By default, Setup assumes that your controller is an ISA device rather than a PCI controller. The most apparent difference is the type of slot being used. If you have equipped your system with a PCI controller, changing this allows you to specify which slot holds the controller and which PCI interrupt (A,B,C,D) is associated with the connected hard disk. This setting refers to the hard disk drive itself, rather than individual partitions. Since each IDE controller supports two separate hard drives, you can select the INT# for each. Again, you will note that the primary has a lower interrupt than the secondary as described in “*lot x Using INT#*” above. Select ‘PCI Auto’ allows the system to automatically determine how your IDE disk system is configured.

Assign IRQ for
USB

When this items is enabled, the system will assign an IRQ for USB. If this item is disabled, the USB will not occupy an IRQ; therefore the IRQ of USB will be released for other usage.

Assign IRQ for
VGA

When this items is enabled, the system will assign an IRQ for VGA. If this item is disabled, the VGA will not occupy an IRQ; therefore the IRQ of VGA will be released for other usage.

This section page includes all the items of IDE hard drive and Programmed Input/Output features. See also Section “Chipset Features Setup”.

ROM PCI/ISA BIOS (ATC-5220)
 CMOS SETUP UTILITY
 AWARD SOFTWARE, INC.

STANDARD CMOS SETUP	INTEGRATED PERIPHERALS
BIOS FEATURES SETUP	SUPERVISOR PASSWORD
CHIPSET FEATURES SETUP	USER PASSWORD
POWER MANAGEMENT SETUP	IDE HDD AUTO DETECTION
PNP/PCI CONFIGURATION	SAVE & EXIT SETUP
LOAD BIOS DEFAULTS	EXIT WITHOUT SAVING
LOAD SETUP DEFAULTS	
ESC: Quit	↑↓→←:Select Item
F10: Save & Exit Setup	(Shift) F2 : Change Color
Time, Date, Hard Disk Type	

ROM PCI/ISA BIOS (ATC-5220)
 INTEGRATED PERIPHERALS
 AWARD SOFTWARE, INC.

OnChip IDE First Channel : Enabled	Onboard Parallel Port : 378/IRQ7
Onchip IDE Second Channel : Enabled	Onboard Parallel Mode : ECP
IDE Prefetch Mode : Enabled	ECP Mode Use DMA : 3
IDE HDD Block Mode : Enabled	
IDE Primary Master PIO : Auto	
IDE Primary Slave PIO : Auto	
IDE Secondary Master PIO : Auto	
IDE Secondary Slave PIO : Auto	
IDE Primary Master UDMA : Auto	
IDE Primary Slave UDMA : Auto	
IDE Secondary Master UDMA : Auto	
IDE Secondary Slave UDMA : Auto	
Init AGP Display First : Disabled	
Onboard FDC Controller : Enabled	
Onboard UART 1 : 3F8/IRQ4	Esc: Quit ↑↓→← :Select Item
Onboard UART 2 : 2F8/IRQ3	F1 : Help PU/PD/+/- : Modify
Onboard UART 2 Mode : Standard	F5 : Old Values (Shift) F2: Color
	F6 : Load BIOS Defaults
	F7 : Load Setup Defaults

OnChip IDE First Channel
OnChip IDE Second Channel

This setup item allows you to either enable or disable the primary/secondary controller. You might choose to disable the controller if you were to add higher performance or specialized controller.

IDE Prefetch Mode

Enable/Disable IDE Read Prefetch Buffer.

IDE HDD Block Mode

This allows your HD controller to use the fast block mode to transfer data to and from your HDD drive

Enabled	IDE controller uses block mode
Disabled	IDE controller uses standard mode

IDE Primary Master/Slave PIO
IDE Secondary Master/Slave PIO

PIO - Programmed Input/Output, it allows the BIOS to tell the controller what it wants and then let the controller and the CPU to complete the task by themselves.

This is simpler and more faster. Your system supports five modes, 0 - 4, which primarily differ in timing. When **Auto** is selected, the BIOS will select the best available mode.

IDE Primary Master/Slave UDMA
IDE Secondary Master/Slave UDMA

Auto, will support the Ultra DMA function.

Disabled, will not support the Ultra DMA function.

Init AGP Display First

This item will activate the AGP in the multi-display environment , it displayed, if disabled, and the system has both AGP and PCI VGA card, the AGP monitor will not display.

KBC input clock

Let user change the keyboard working clock.

On Board FDC Controller

This item will enable or disable the floppy disk controller.

On Board UART Port 1

User can select serial port IRQ. If set to 3F8/IRQ4, system will assign an IRQ for it. Note : set to Auto is not recommended.

On Board UART Port 2

User can select serial port IRQ. If set to 2F8/IRQ3, system will assign an IRQ for it. Note : set to Auto is not recommended.

**OnBoard UART
2 Mode**

This lets you select the Infrared mode. Choices are Standard, HPIR, and ASKIR. If you choose HPIR or ASKIR mode, the screen will show another two lines to let you choose 'IR Function Duplex' (Full or Half) and 'RxD TxD Active' (Hi Lo; Lo Hi; Hi Hi;Lo Lo).

**On Board
Parallel Port**

Let user select IRQ for parallel port, when Disabled, the parallel port will be disabled

**On Board
Parallel Mode**

Let user select error check mode. This item is not recommended to change except user has special request.

**ECP Mode
Use DMA**

Select a DMA channel for the port.
Choices are 3, 1.

The last second step is 'save and exit'. If you select this item and press 'Y', then these records will be saved in the CMOS memory on the mainboard. It will be checked every time you turn your computer on.

ROM PCI/ISA BIOS (ATC-5220)
 CMOS SETUP UTILITY
 AWARD SOFTWARE, INC.

STANDARD CMOS SETUP	INTEGRATED PERIPHERALS
BIOS FEATURES SETUP	SUPERVISOR PASSWORD
CHIPSET FEATURES SETUP	USER PASSWORD
POWER MANAGEMENT SETUP	IDE HDD AUTO DETECTION
PNP/PCI CONFIGURATION	SAVE & EXIT SETUP
LOAD BIOS DEFAULTS	EXIT WITHOUT SAVING
LOAD SETUP DEFAULTS	
ESC: Quit	↑↓→←:Select Item
F10: Save & Exit Setup	(Shift) F2 : Change Color
Time, Date, Hard Disk Type	

ROM PCI/ISA BIOS (ATC-5220)
 STANDARD CMOS SETUP
 AWARD SOFTWARE, INC.

STANDARD CMOS SETUP	INTEGRATED PERIPHERALS
BIOS FEATURES SETUP	PASSWORD SETTING
CHIPSET FEATURES SETUP	IDE HDD AUTO DETECTION
POWER MANAGEMENT SETUP	SAVE & EXIT SETUP
PNP/PCI CONFIGURATION	EXIT WITHOUT SAVING
LOAD BIOS DEFAULTS	SAVE to CMOS and EXIT (Y/N):Y
ESC: Quit	↑↓→←:Select Item
F10: Save & Exit Setup	(Shift) F2 : Change Color
Save Data to CMOS & Exit SETUP	

LOAD BIOS DEFAULTS

When your mainboard has problems and needs to trouble shoot the system, you can use this function. The default values loaded only affect the BIOS Features Setup, Chipset Features Setup, Power Management Setup and PNP/PCI Configuration Setup. There is no effect on the Standard CMOS Setup. To use this function, select it from main menu and press <Enter>. A line will appear on the screen asking if you want to load the BIOS default values. Press <Yes> and <Enter> then the BIOS default values will be loaded.

LOAD SETUP DEFAULTS

This allows you to load optimal settings which are stored in the BIOS ROM. The default values loaded only affect the BIOS Features Setup, Chipset Features Setup, Power Management Setup and PNP/PCI Configuration Setup. There is no effect on the Standard CMOS Setup. To use this function, select it from main menu and press <Enter>. A line will appear on the screen asking if you want to load the Setup default values. Press <Yes> and <Enter> then the Setup default values will be loaded.

SUPERVISOR PASSWORD / USER PASSWORD

This allows you to set the password. The mainboard defaults with password disabled.

Enter/Change password : Enter the current password, at the prompt, key-in your new password (up to eight alphanumeric characters), press <Enter>. At the next prompt, confirm the new password by typing it again and press <Enter>.

Disable password : Press the <Enter> key instead of entering a new password when the 'Enter Password' dialog box appears. A message will appear confirming that the password is disabled.

If you set both supervisor and user passwords, only the supervisor password allows you to enter the BIOS SETUP program.

CAUTION :If you forgot your password, you must disable the CMOS by turning power off and set JP 8 to ‘close’. And then open reload the system.

IDE HDD AUTO DETECTION

This allows you to detect the IDE hard disk drivers‘ parameters and enter them into ‘Standard CMOS Setup’ automatically.

If the auto-detected parameters displayed do not match the ones that should be used for your hard drive, do not accept them. Press <N> to reject the values and enter the correct ones manually on the Standard CMOS Setup screen.

SAVE & EXIT SETUP

This allows you to save the new setting values in the CMOS memory and continue with the booting process. Select what you want to do, press <Enter>.

EXIT WITHOUT SAVING

This allows you to exit the BIOS setup utility without recording any new values or changing old ones.

※ Control Key Description ※

UP ARROW	↑	Move to previous item
DOWN ARROW	↓	Move to next item
LEFT ARROW	←	Move to the item in the left hand
RIGHT ARROW	→	Move to the item in the right hand
Esc KEY	Esc	Main Menu : Quit and not save changes Setup menu : Exit current page and return to main menu
PgUp KEY		Increase the numeric value or make changes
PgDn KEY		Decrease the numeric value or make changes
F1 KEY	Help	General help
F2 KEY	< Shift > +F2	Change color from total 16 colors
F5 KEY	Old Value	Restore the pervious CMOS value from CMOS
F6 KEY	Load BIOS default	Load the default CMOS value from BIOS default table
F7 KEY	Load setup default	Load Setup default
F10 KEY	Save & Exit Setup	Save all the CMOS changes and Exit setup, only for Main Menu

APPENDIX A

※※TECHNICAL SUPPORT REQUEST FORM※※

If the mainboard doesn't function properly, please complete the following information and return it to your system dealer. If the further information is needed, please attach it.

Model No : ATC-5220 Date of Purchase : _____

Serial No : _____

HARDWARE :

	BRAND	MODEL	SPEED	Q'TY
DIM Module				

CPU SPEED : _____ MHz

DRAM : _____ MB (_____ SDRAM/EDO DRAM)

Hard Disk Interface Controller : _____ IDE, _____ SCSI

Hard Disk Brand : _____, Model : _____, Capacity : _____

Display Controller Brand : _____, Model : _____

Controller Chip Brand : _____, Model : _____

SOFTWARE:

Award SYSTEM BIOS: Version _____ Date Code _____

Other Add-on Cards Information:

Add-on Card	Bus Interface	Model	Remark

Error Description