

6AAP5
(ALI M1651 DDR Chipset)
ATX Form Factor
Main Board
User's Manual
(Ver.:1.0)

Copyright

Copyright© 2001 by this company. No part of this document may be reproduced, transmitted, transcribed, stored in a retrievable system, or translated into any natural or computer language, in any form or by any means without prior written permission. This manual and the information contained herein are protected by copyright. All rights reserved.

Revision	Date	Release Notes	Ref. No
1.0	May-2001	First Official Release	3053324

Warning and disclaimer

This manual is designed to provide information about the Pentium® II/III main board. Every has effort have been made to make this manual as accurate as possible, but no warranty or fitness is implied. All the information is provided on an 'as is' basis. The author and his corresponding publishing company shall have neither liability nor responsibility to any person or entity with respect to any loss or damages arising from the information contained in this manual or from the use of the system board that accompanies it.

Information contained in this manual is subject to change without notice. The manufacturer of the system board will not be held responsible for technical or editorial omissions made herein, nor for the incidental or consequential damages resulting from its furnishing, performance, functionality or use. Subsequent changes to this manual will be incorporated into the next edition. We welcome any suggestion regarding this manual or our computer products.

Trademarks

- Intel® and Pentium® are registered trademarks of Intel® Corporation.
- IBM® is a registered trademark of International Business Machines Corporation.
- Microsoft® is a registered trademark of Microsoft® Corporation.
- PCI® is a registered trademark of PCI® Special Interest Groups.
- AWARD® is a registered trademark of Award Software Inc.

All other trademarks are the property of their respective owners.

Table of Contents

Chapter 1	Introduction.....	3
1-1	Main Board Overview.....	4
1-2	Specifications.....	5
1-3	Other Features.....	8
1-4	Notice of Hardware Installation.....	9
1-5	Notice of CD Driver Installation.....	10
1-6	Software Driver Installation.....	11
Chapter 2	Installation.....	12
2-1	Layout Reference.....	12
2-2	Jumper Setting.....	13
2-2-1	JP1-JP3:Audio/AMR Function Selector.....	13
2-2-2	JP5/JP7:CPU Type Selector.....	14
2-2-3	JBAT1:CMOS Status.....	15
2-2-4	JP6: System monitoring with speech (Language Selector)	16
2-2-5	VID0-VID4:CPU VCORE.....	17
2-2-6	S1:CPU Frequency Selector.....	19
2-2-7	JP4:CNR PRIMARY/ SECONDARY Selector.....	20
2-3	Connectors	21
2-3-1	Front Panel.....	21
2-3-2	Back Panel.....	23
	COM1/COM2.....	24
	LPT1 (Parallel Port).....	24
	USB1/USB2(Universal Serial Bus).....	24
	AT Keyboard	24
	PS/2 Mouse.....	24
2-3-3	ATX Power Supply Connector.....	25
2-3-4	IR: IrDA Connector.....	26
2-3-5	CPU Fan & System Fan Connectors.....	27
2-3-6	Floppy Disk Connector.....	28
2-3-7	IDE1 & IDE2.....	29
2-3-8	WOL1: Wake up on LAN.....	30
2-3-9	WOM1: Wake up on Modem.....	31
2-3-10	CD_IN.....	32
2-4	DIMM Memory Installation.....	33
2-4-1	Memory Installation.....	34

Chapter 3	BIOS Setup.....	35
3-1	The BIOS Setup Page.....	35
3-2	Standard CMOS Setup.....	38
3-3	BIOS Features Setup.....	42
3-4	Chipset Features Setup.....	46
3-5	Integrated Peripherals.....	48
3-6	Power Management Setup.....	51
3-7	PNP/PCI Configuration Setup.....	55
3-8	PC Health Status.....	57
3-9	Frequency/Voltage Control.....	58
3-10	Password Setting.....	59
3-11	Load Optimized Defaults.....	62
Chapter 4	Appendix.....	63
4-1	Memory Map.....	63
4-2	I/O Map.....	64
4-3	Time & DMA Channels Map.....	65
4-4	Interrupt Map.....	66
4-5	RTC & CMOS RAM Map.....	67
4-6	ISA I/O Address Map.....	68
Chapter 5	Q & A.....	70
5-1	Error Messages During Power On Self Test.....	70

Important Warnings:



WARNING: NEVER run the processor without the heatsink properly and firmly attached. This will damage the processor within SECONDS. Also do NOT try to use Pentium Heatsinks, these will NOT fit and do NOT provide adequate cooling.



WARNING: Make sure your power supply can deliver the power your system needs. We recommend AT LEAST a 250W power supply. Even better, get a 300W power supply, especially when using many peripherals.

Chapter 1 Introduction

Thank you for purchasing this high quality Motherboard, we are confident that you will be able to use this motherboard to your full satisfaction. This manual is divided into 4 main sections, as described below

Introduction

The introduction contains information on the main specifications for the 6AAP5 motherboard, the package contents and cautionary notes.

Hardware Installation

The Hardware Installation section is the most important in the manual. It describes in detail how to set the motherboard up for operation. Read all information and follow all steps, especially if you are a new user.

BIOS Setup

Information on how to enter the BIOS setup and change settings is given here. In addition all individual BIOS items are described. Although some BIOS Setting information is given in the hardware installation section where appropriate, refer to the BIOS Setup Section for details.

Appendix

Provides useful information

1-1 Main Board Overview

The main board's design is based on ALI chipset, "M1651 (ALADOW PRO-5) / 1535D+," which provides a high-performance/desktop solution to the Intel® FC-PGA(or PPGA) Celeron/ PentiumIII & VIA Cyrix® III Processors.

The main board supports up to 3GB of 200/266MHz DDR-SDRAM main memory which is a new memory technology that provides up to twice the bandwidth of SDRAM memory, significantly improving the performance of the PC system.

The main board integrates PCI-mastering dual full-duplex direct-sound AC97-link-compatible sound system. Hardware soundblaster-pro and hardware-assisted FM blocks are included for Windows DOS box and real-mode DOS compatibility. Loopback capability is also implemented for directing mixed audio stream into USB and 1394 speaker for high quality digital audio.

The main board also implements high performance I/O Controller utilizing with fully Plug and Play device which supports 2.88 MB Floppy, Dual 16550 Compatible (with 16 bytes FIFO, up to 460K baud rate) Serial Port, ECP (Enhanced Capabilities Port), EPP (Enhanced Parallel Port) parallel port, Infrared IrDA (HPSIR), and Amplitude Shift Keyed IR. (ASKIR) port.

The main board is also strengthened with Power Management Wake up Event such as "WOL (Wake up on LAN)," "Modem ring on" which are the new inventions to enable PCs to be turned on over the network. These are also key benefits in PC operation, new system setup and power conservation.

In conclusion, the main board is a combination of the highest in performance, flexibility, efficiency, and ease of use that meets a variety of price/performance levels. The main board is an ideal platform for the increasing requirements of today's and future's desktop application.

1-2 Specifications

- **PCB board size:** 21 cm x 30.5 cm

- **PCB layer:** 4 layers

- **Socket 370**

The following Socket370-based Intel® Pentium III™\ Celeron™ or VIA Cyrix® III CPUs are supported:

Intel PIII (800, 850, 900, 950, 1000 MHz)

Celeron (600, 700, 800MHz)

VIA CyrixIII (600, 667, 700 MHz)



The frequencies listed were those known at the time of publication.

- **Chipset Northbridge:**

The ALI M1651 (PRO-5) system controller supports a 66/100/133 MHz Front Side Bus (FSB); up to 3GB of 200/ 266 DDR; the 6AAP5 complies with AGP 2.0 specifications for 4X, 2X, and 1X AGP modes and PCI 2.2. bus integrate with support for 6 PCI masters. It was designed especially to deliver enhanced Intel Pentium!!!™/ Celeron™ or VIA Cyrix®III processors system performance.

- **Chipset Southbridge:**

The M1535D+ integrates UDMA 66/100, super I/O with fast IR & PS/2 K/B, Mouse controlens. Also supports ACPI, power management functions.

- **Memory :**

The 6AAP5 comes equipped with three Double Data Rate (DDR) Memory Module sockets to support Intel PC133DDR 200MHz/266MHz –compliant (4, 16, 64, 128,256, or 512MB) DDR modules up to 3GB.

● **Expansion Slot** : 6 x PCI slots, 1x AGP slot, 1x CNR slot

- PCI Expansion Slots

With six 32-bit PCI (Rev. 2.2) expansion slots, which can support Bus Master PCI cards, such as LAN or Video-grabber cards (PCI supports up to 133MB/s maximum throughput), the 6AAP5 motherboard is ready for the most demanding applications.

- AGP Slot

The 6AAP5 comes with an AGP Slot with Support for AGP cards for high performance. The AGP 133MHz 4X mode is supported as well, further increasing system performance.

- CNR Slot

A Communication NetworkingRiser (C.N.R.) slot also is supported, a very-affordable audio an / or modem. LAN riser card can be used in combination with this slot.

● **Audio/Sound Function**

Hardware controller → AC97-link-compatible sound system

- Microsoft® PC97/PC98 compliant
- Meets WHQL audio requirement

● **I/O function**

- 4 x PCI IDE devices
- 1 x FDC, 2 x serial ports(16550 fast COM.)
- 1x parallel port device /EPP/ECP/SPP
- 2 x USB connector (4 port, 2 port optional)
- IrDA (infrared) connector

● **IDE interface**

The 6AAP5 comes with an onboard PCI Bus Master IDE controller with two connectors that support four ATA33/66/100 devices on two channels. Supports UDMA/33, UDMA/66, UDMA/100, PIO MODES 3 & 4 and Bus Master IDE DMA Mode 2, and Enhanced IDE devicesm such as CD-R/RW, DVD-ROM, CD-ROM, Tape Backup an LS-120 drives.

-
- **USB interface:**
With support for up to 2 USB ports, which on the back panel, the 6AAP5 Provides ample USB expansion room.
 - **Infrared (IrDA) Connector**
This functionality is also integrated into the chipset. The IrDA connector supports an optional IR remote control device for wireless interfacing with external peripherals, personal gadgets, or an optional remote controller.
 - **ATX form factor:**
The ATX form factor has been defined to address four major areas of improvement required of today's predominant form factors.
 - Enhance PC ease-of-use with all built-in I/O connector
 - Better support for current and future I/O
 - Reduce total system cost
 - Better support for future processor technologyATX is an evolution of the popular Baby-AT form factor. By mounting the power supply on its side, the processor is relocated away from the expansion slots, and the longer side of the board is used to host more on-board I/O connector; this placing of I/O on the board reduces cabling inside the box, lower costs, and improves reliability and ease-of use. A flexible I/O panel allows ATX to support all current and future I/O requirements. The ATX power supply will directly suck the air out of chassis that will save the cost of a secondary fan in the system. System cost is further reduced by the higher integration of PC components onto the system board itself, saving materials, inventory holding, and assembly cost.
 - **Green function :** Complied with APM (Advanced Power Management)
 - **Special features**
 - Windows power off (ATX power supply required)

1-3 Other Features

- **Wake-On-LAN and Wake-On-Modem:**
These 3-pin connectors allow the motherboard to wake up on network (WOL) or Modem (WOM) activity.
- **PC Status Monitoring:**
This functionality provides a reliable way to examine and manage system status information, such as CPU and system voltages, temperatures, and fan speed. This information is available in the BIOS or through the ALI Hardware Monitor Software.
- **System BIOS:**
The 6AAP5 comes with a 2MB BIOS that provides , boot block write protection, and HD/ SCSI/ CD/ Floppy boot selection. DMI is also supported through BIOS, which allows hardware to communicate within a standard protocol creating a higher level of compatibility.
- **Color-coded Connectors**
The Back-panel connectors of this motherboard are all color coded. This allows the user to easily locate certain connectors.

1-4 Notice of Hardware Installation

Before hardware installation, make sure you have checked the following things.

A. Check the package

If any of these items is missing or damaged, contact the dealer from whom you purchase. Leave this main board in its original package until you are ready to install it. In the package, there are:

- The 6AAP5 Motherboard
- 1 Manual
- 1 Driver Installation CD-ROM
- 1 IDE ATA 66/100 Flat-Cable
- 1 Floppy Disk Drive Flat-Cable



B. Make sure power is off.

During hardware installation, be sure that there is no power connected during this period.

C. Avoid ESD (Electrical Static Discharge).

While installing the main board, wear a grounded wristband or ankle strap to avoid ESD (Electrical Static Discharge).

1-5 Notice of CD Driver Installation

This CD contains below drivers. The user must read “Index” (HTML format) before installing required drivers. Index offers all the information on all the drivers.

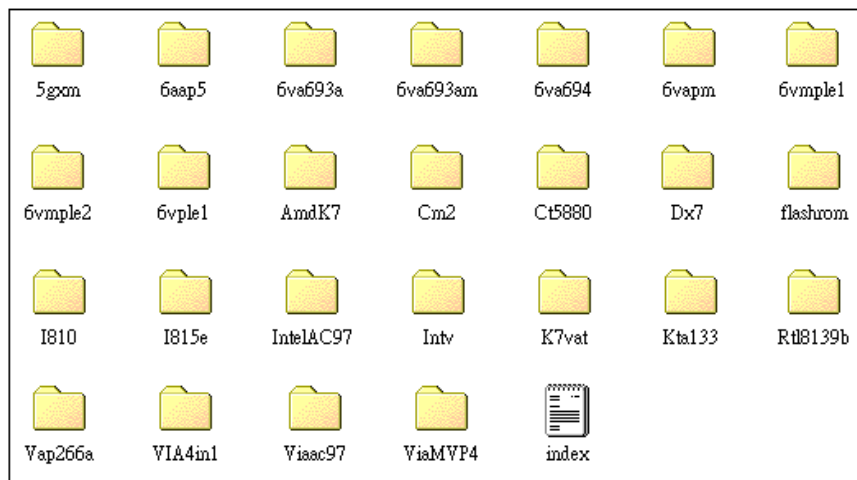

CD driver is always updated with the latest version, so the actual CD content may be somewhat different from the above picture.

1. **Main boards:** 5gxm, 6aap5, 6va693a, 6va693am, 6va694, 6vapm, 6vmp1, 6vmp2, 6vple1, Amdk7, I810, I815e, Intv, K7vat, Kx133, Vap266a, ViaMVP4 (**please choose 6aap5 directory for this main board**).
2. **DX7:**windows DirectX7 driver.(for 3D game.....)
3. **Flashrom:**BIOS flashupgrade utility.

1-6 Software Driver Installation

It is recommended to do a clean installation of Windows when you first install your 6AAP5 motherboard. Immediately after installing Windows95/98 or Windows NT you should install the latest ALI drivers for the motherboard. The original ALI drivers are included on the driver CD which accompanied these motherboard.

The following installation procedure for Windows 98(SE) is a safe way of installation of all drivers:

- Boot into DOS using a start up floppy, now
Use FDISK to create DOS partition on disk (this destroys existing data on disk)
Format C: / S to format disk (this destroys existing data on disk)
- Install Windows
- Install the VGA Driver from CD
Path root: \6AAP5\Agpdrv\setup.exe
- Install the Sound Driver
Windows 95 Path root: \6AAP5\AUDIO\Win95\SETUP.EXE
Windows 98 Path root: \6AAP5\AUDIO\Win98\SETUP.EXE
Windows NT Path root: \6AAP5\AUDIO\WinNT\SETUP.EXE
- Optional: Install the latest DirectX and run latest patches.
Go to the DX7 directory on the CD and run the setup.exe file
- Install the other latest drivers, e.g. joystick, graphics tablet, etc
- Install the applications.

The principle is to work up from the most basic software towards the higher level applications. It may be advisable to defrag before and after installing DirectX, but this should be unnecessary if the disk was formatted before installation.

Chapter 2 Hardware Installation

2-1 Layout Reference

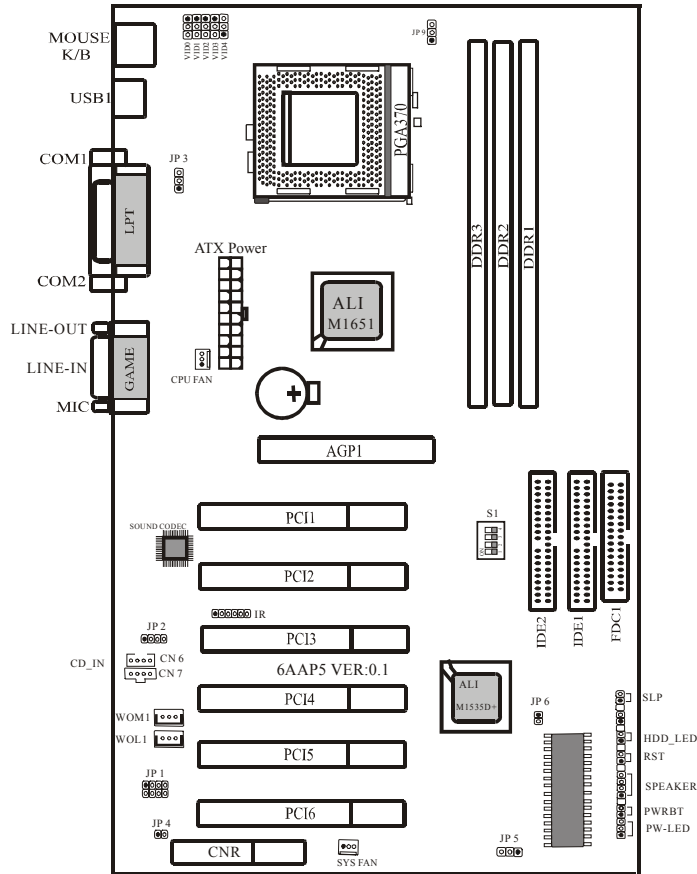

2-2 Jumper Settings

2-2-1 JP3 : Keyboard and Mouse Wake up function

JP3 is a 3-pin selector which provides Keyboard and Mouse wake up function. Set "1-2" to disable and set "2-3" to enable keyboard wake up function.

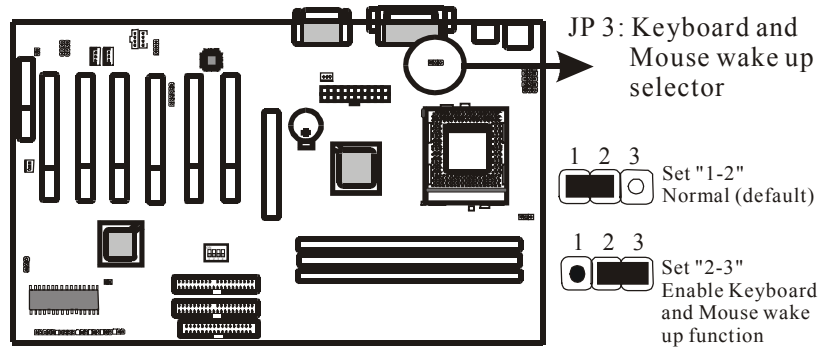

2-2-2 JP9 : CPU Type Selector

JP9 is 3-pin connectors which provide to select CPU type. Please select the right CPU type as below.

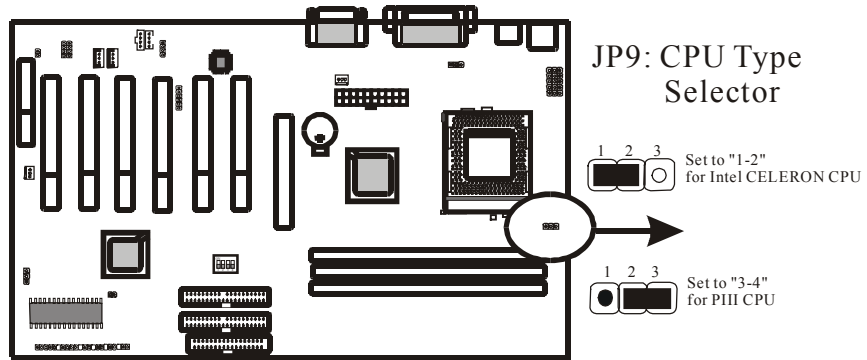

2-2-3 JP5: CMOS Status

JP5 is a 3-pin connector. Clear CMOS if system password is forgotten. Below are details to show how to clear CMOS.

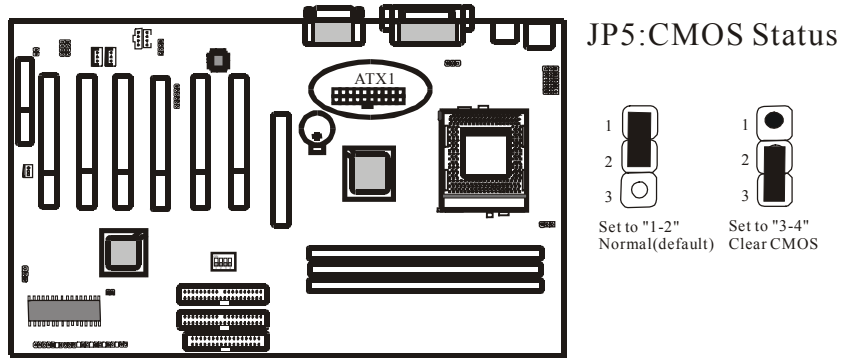

Procedure to clear CMOS:

- Step 1: Shut down the system and disconnect the power supply from AC power.
- Step 2: Pull out the power cable from ATX connector "ATX1".
- Step 3: Short the CMOS jumper by putting jumper cap on Pin 2-3 for a few seconds.
- Step 4: Return to pin 1-2 for normal setup.
- Step 5: Link ATX power cable to ATX connector & connect AC power to power supply.
- Step 6: Turn on system power.



If you'd like to set password, press "DEL" Key during system bootup to enter CMOS setup and establish a new password.

2-2-4 JP6: System monitoring with speech (Language Selector)

The 6AAP5 motherboard comes with a sound IC that will tell the user in spoken English (English or Chinese can be selected) what is wrong with the motherboard in case of boot problems.

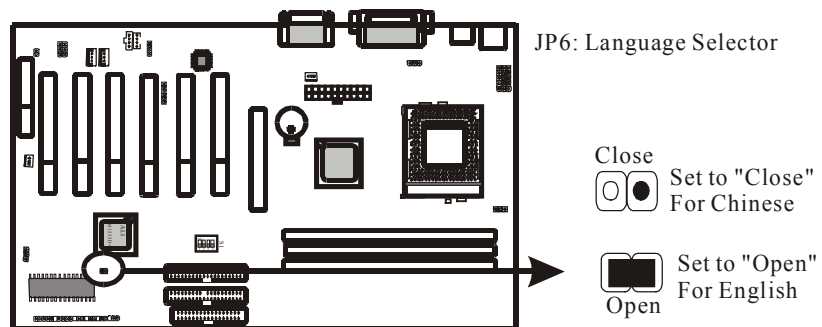

2-2-5 VID0-VID4: CPU VCORE

VID0-VID4 are 3-pin connectors which provides CPU Vcore selection. Please select the right Vcore according to your CPU and details as below.

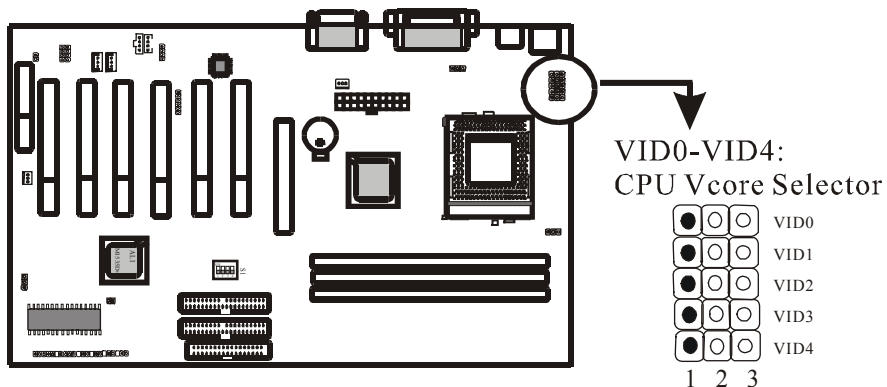

VID0-VID3	VID4
Default (1-2)	Default (2-3) : for Intel PII/ PIII CPU/ CyrixIII CPU

VID4	VID3	VID2	VID1	VID0	CPU Volt.
1-2	2-3	1-2	1-2	1-2	2.8V
1-2	1-2	2-3	2-3	2-3	2.7V
1-2	1-2	2-3	2-3	1-2	2.6V
1-2	1-2	2-3	1-2	2-3	2.5V
1-2	1-2	2-3	1-2	1-2	2.4V
1-2	1-2	1-2	2-3	2-3	2.3V
1-2	1-2	1-2	2-3	1-2	2.2V
1-2	1-2	1-2	1-2	2-3	2.1V
1-2	1-2	1-2	1-2	1-2	2.0V
2-3	2-3	2-3	2-3	2-3	2.05V

2-3	2-3	2-3	2-3	1-2	2.00V
2-3	2-3	2-3	1-2	2-3	1.95V
2-3	2-3	2-3	1-2	1-2	1.90V
2-3	2-3	1-2	2-3	2-3	1.85V
2-3	2-3	1-2	2-3	1-2	1.80V
2-3	2-3	1-2	1-2	2-3	1.75V
2-3	2-3	1-2	1-2	1-2	1.70V
2-3	1-2	2-3	2-3	2-3	1.65V
2-3	1-2	2-3	2-3	1-2	1.60V
2-3	1-2	2-3	1-2	2-3	1.55V
2-3	1-2	2-3	1-2	1-2	1.50V
2-3	1-2	1-2	2-3	2-3	1.45V
2-3	1-2	1-2	2-3	1-2	1.40V
2-3	1-2	1-2	1-2	2-3	1.35V
2-3	1-2	1-2	1-2	1-2	1.30V



Please don't change default setting. The manufacturer shall have neither liability nor responsibility to any person or entity with respect to any loss or damages arising by users' over-clocking or over-voltage.

2-2-6 S1: CPU Frequency Selector

The frequency the CPU runs at internally depends on the FSB (Front Side Bus) Frequency that is provided to it and the multiplier setting. As example, a 800MHz CPU would run at 100MHz with a multiplier setting of 8x.

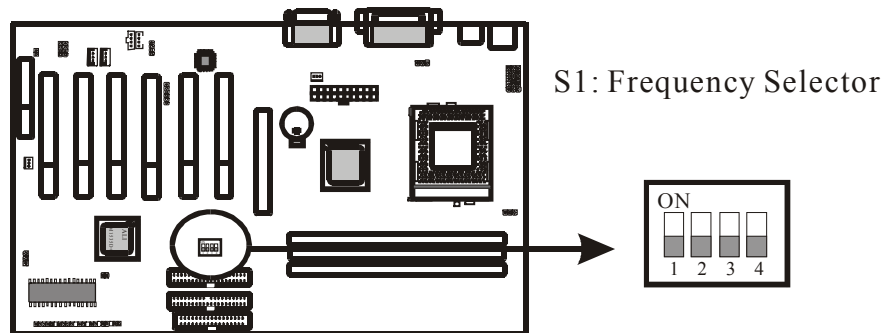

S1				CPU	DRAM	AGP	PCI
1	2	3	4				
ON	ON	ON	ON	66MHz	66MHz	66MHz	33MHz
ON	ON	ON	OFF	66MHz	100MHz	66MHz	33MHz
ON	ON	OFF	ON	100MHz	66MHz	66MHz	33MHz
ON	ON	OFF	OFF	100MHz	100MHz	66MHz	33MHz
ON	OFF	ON	ON	100MHz	133MHz	66MHz	33MHz
ON	OFF	ON	OFF	120MHz	120MHz	60MHz	30MHz
ON	OFF	OFF	ON	133MHz	100MHz	66MHz	33MHz
ON	OFF	OFF	OFF	133MHz	133MHz	66MHz	33MHz

2-2-7 JP4: CNR PRIMARY/ SECONDARY Selector

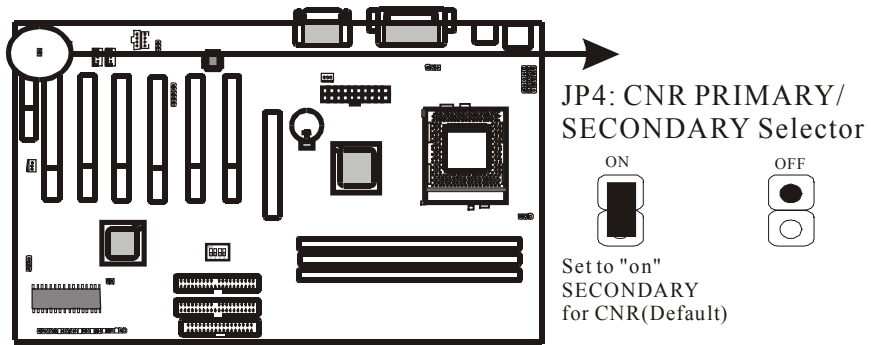

2-3 Short description of main sockets and Connectors

There are many connectors on this main board. Refer to the following pages for details.

2-3-1 Front Panel

The front panel connector strip is located near the battery and the BIOS IC. It will allow you to connect LEDs and Switches in your case to the motherboard. It has connectors as “PW-LED,” “PWRBT,” “SPEAKER,” “RST,” “HD-LED,” and “SLT.” Please refer to the following picture for the lay-out of the front panel connector strip:

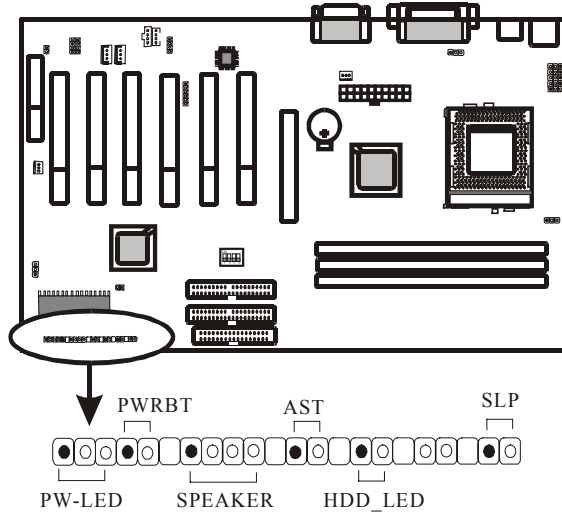

- ***PW-LED***

The Power LED connector allows you to connect a three pin LED from the case. Notice the polarity, LEDs will only light up if the polarity is correct.

- ***PWRBT***

PW-BT with a 2-pin Berg strip on case front panel indicates the current power status of system. It is used to connect to the Power Button on the front panel of the case (if there is).

- ***SPEAKER***

The speaker connector is for internal case speaker. This speaker will enable the BIOS to give spoken messages in case of boot up trouble. The BIOS beep codes also use this speaker. For Games and Music this speaker will not be used, but rather the back panel line-out connector.

- ***RST***

The reset connector is for connection of the reset switch. This switch, when pressed, will immediately reset the system (that is, no matter what you were doing, the system will restart. This is very similar to powering to system off and then on again). Note that Windows, Linux and other operating systems do not appreciate the use of the reset switch. When you are working under windows, always use the shutdown feature under the start button (Ues, very logical).

- ***HD-LED***

The HD-LED (Hard Disk activity LED connector) will light up whenever one of your IDE devices is being accessed. Usually this will be a harddisk, as such the name HDD-LED.

- ***SLP***

This is the External System Management Interrupt Button connector. Connect the second button on your ATX case to this connector. Pressing of the suspend state, and of the wake-up events that can wake the system up again).

2-3-2 Back Panel

There are keyboard/ mouse, USB, COM1/2, LPT1, MIC, LINE-IN, LINE-OUT and GAME Port on case back panel. Please refer to more details as below.

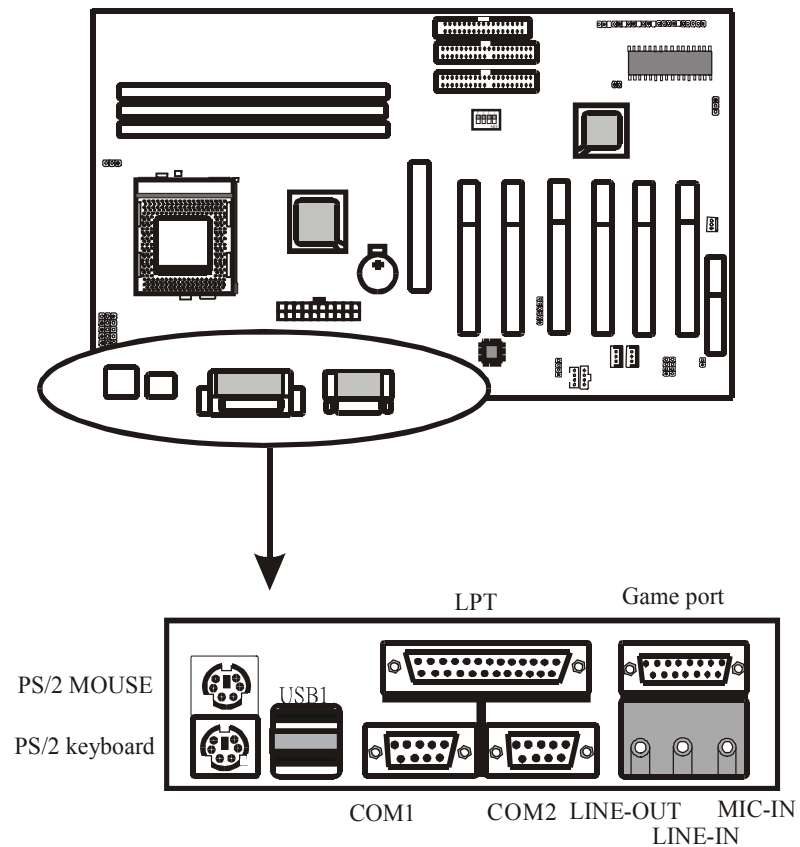

COM1/COM2

The onboard serial port 1 and port 2 are the 9-pin D-subminiature male connector **COM1 and COM2**. COM1 and COM2 can be disabled in BIOS setup. Please refer to Chapter 3 “Integrated Peripherals” for more information.

PS2 Keyboard/ Mouse

The Keyboard can be plugged in in only one way. Please do not force the connector in, it may get damaged by use of excessive force. It is easy to make the mistake of reversing the PS/2 keyboard and mouse connectors. If your keyboard does not work, check this first. The keyboard must be inserted into the lower connector.

The Mouse can be plugged in in only one way, too. Please do not force the connector in, it may get damaged by use of excessive force.

LPT

The onboard parallel port is a 25-pin female connector. It supports standard printer port, Enhanced Parallel Port (EPP), Extended Capabilities Port (ECP), Standard Parallel Port (SPP).

USB:USB (Universal Serial Bus) Connector

Universal Serial Bus connector, marked as “USB,” is used to connect USB devices. There are 2 USB connectors on this main board.

Midi/Game Port & External Audio Connectors

Midi/Game port has 15 pins connecting to the game joystick. External Audio connectors are “LINE-OUT, LINE-IN, MIC-IN” for audio functions.

2-3-3 ATX Power Supply Connector

The ATX power supply connector is where your power supply plug must be inserted. Note that this motherboard only supports ATX style power supplies, AT style power supplies are not supported. Note the following:

- We recommend use of at least a 250W power supply, if you use a very fast CPU (>900MHz) and have many peripheral devices we recommend use of a 300W power supply. **Do not save on the power supply, it feeds the whole system.**
- If you use WOL and WOM, make sure that power supply can support at least 720mA on the 5V standby line. Anything LESS is unacceptable. Even better, get a 1A 5V standby power supply.

For the lay-out of the ATX connector, please refer to the following picture:

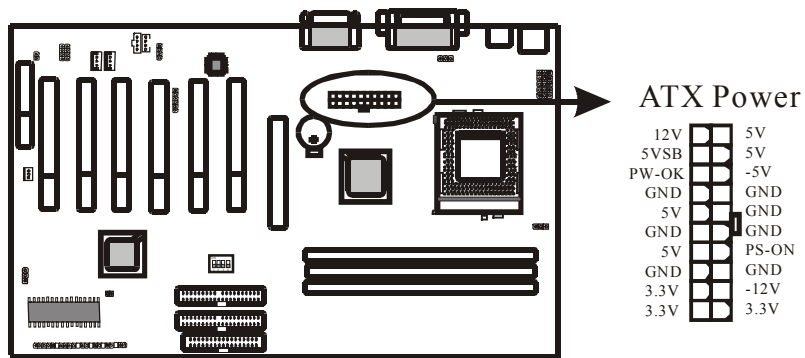

2-3-4 IR: IrDA Connector

If you want to make use of an InfraRed Remote device you can use IR1, a 6-pin header on the motherboard. You will need to buy a separate IR device from your dealer.

IR connector supports wireless infrared module. With this module and application software like LAPlink, or WIN95 Direct Cable Connection, user can transfer data to or from laptops, notebooks, PDA and printers. This connector supports **HPSIR**, **ASKIR**, and **Fast IR** specifications, you will need to set the standard you want to use in the BIOS on the integrated peripherals page..

Attach Infrared module to IR connector. Be sure to put in the right direction during installation. The pin lay-out of IR1 is as follows:

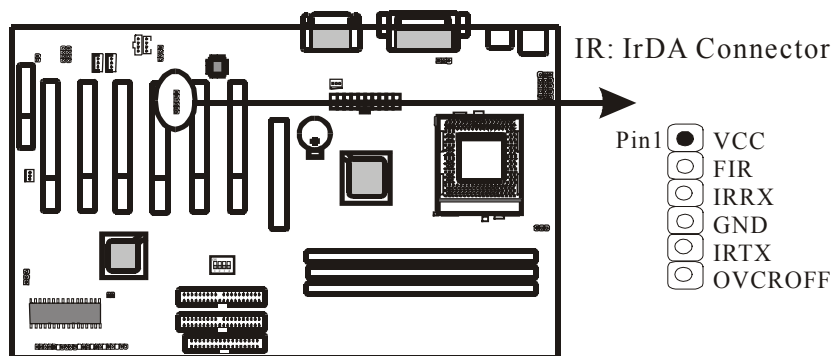

2-3-5 CPU FAN & System FAN Connectors

Any attempt to operate the Intel PIII/ Celeron or VIA CyrixIII processor without a suitable cooling solution will result in permanent damage to the processor and potentially other components within the system.

FAN Headers

Your 6AAP5 Allows the use of in all 2 FANs. Of these 2 FANs, one can used by the CPU Heatsink assembly (Some heatsink assembly come with one FAN). The other FAN Headers allow connectors, refer to the following picture:

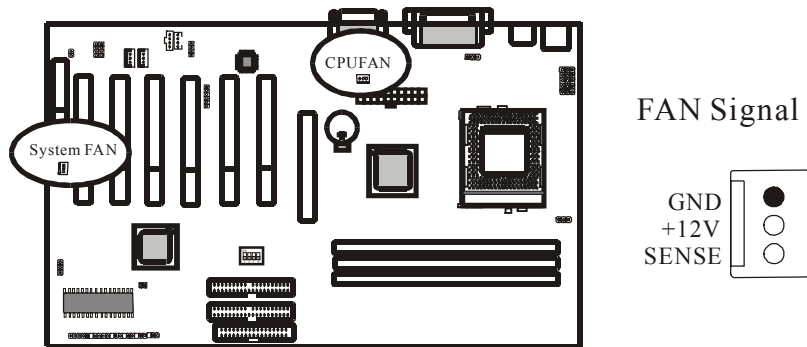

2-3-6 Floppy Disk Connector

Floppy Disk Connector has 34 pins and allows connection of a floppy drive. In all two floppy drives can be connected to the motherboard, known as floppy A and B. The BIOS allows you to disable the floppy controller if you do not use any floppy drives, that will free an Interrupt. The BIOS also allows swapping of floppy A and B although this will not be useful to most users.

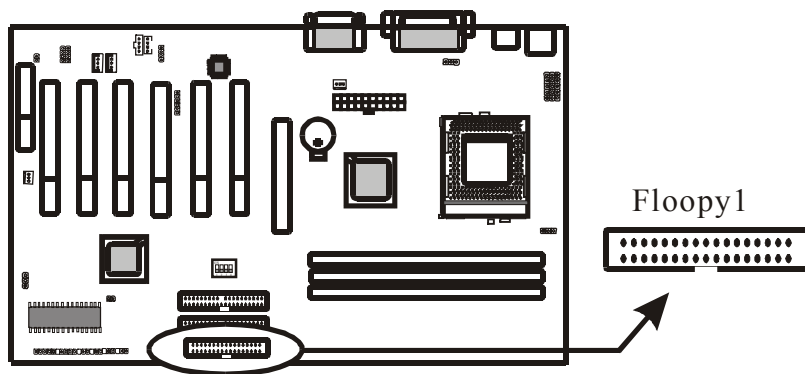

2-3-7 IDE1 and IDE2

The IDE connectors are used to connect IDE devices such as Harddisks and CD-ROM drives to the motherboard. Each connector constitutes an IDE channel, each channel accepts 2 IDE devices, one Master and one Slave. The IDE 1 connector is also known as the primary channel, IDE 2 is the secondary channel. Therefore the primary Master is the IDE device connected to IDE1 as Master, the primary Slave is the IDE device connected to IDE 1 as Slave. Jumpers on the IDE device determine Master and Slave settings. Your harddisk or CD-ROM should have a sticker with jumper settings. Make sure that you set these jumpers correct. Please use the following advice as reference:

- If you have only device connected to an IDE connector, always set it as Master.
- If you have one HDD and CD-ROM in your system, then connect the HDD to IDE 1 as Master, and the CD-ROM to IDE 2 as Master.
- If you have one Harddisk and one CD-ROM connected to the same IDE connector, set the HDD to Master and the CD-ROM to Slave.

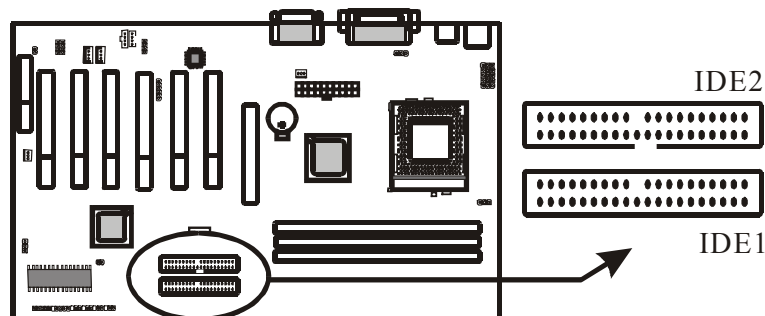

2-3-8 WOL1: Wake up on LAN

Wake up on LAN marked as “WOL,” is a 3-pin connector. To support this feature, a network card is required for the system and network management software must be installed too.

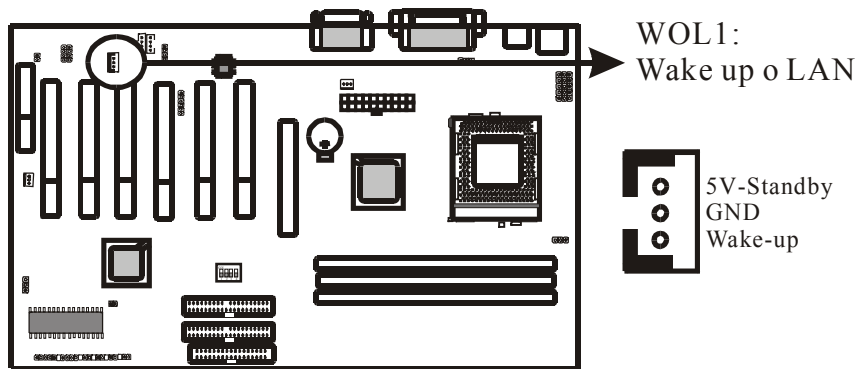

WOL1 (Wake up on LAN) Technical Background:

The Wake up on LAN feature provides the capability to remotely power-on client systems that support Wake up on LAN by simply sending a Wake up on LAN packet. After waking up files can be uploaded to or downloaded from the client. With this feature, network administrators can flexibly perform client maintenance during off-hours so that Total Cost of Ownership (TCO) will be lower. Wake up on LAN is a remote management tool with advantages that can reduce system management workload provide flexibility to the system administrator's job, and of course save time-consuming efforts and costs.

Using Wake up on LAN on your system requires a LAN adapter that supports the Wake up on LAN and software such as LDCM Rev 3.1x or later that can send and receive wake-up packets.

2-3-9 WOM1: Wake up on Modem

The Wake up on Modem Header is described under the PCI section because the WOM Header can accept a cable from a PCI Modem Card that supports Wake up on Modem (Also known as Wake up on Ring). For the pin lay-out of the WOL header, please refer to the picture below.

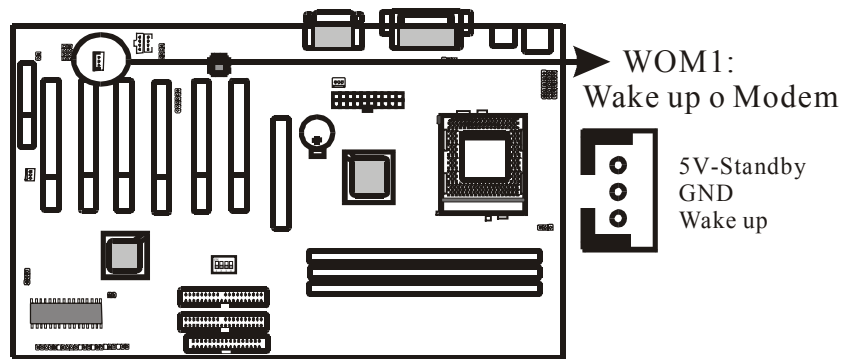

After connecting the WOM cable from your modem to the WOM header, you can set the BIOS to allow the system to wake up when the Modem Card receives a Ring signal.

2-3-10 CD_IN

CD_IN is a CD ROM external audio input signal to line-out (speaker) of the main board.

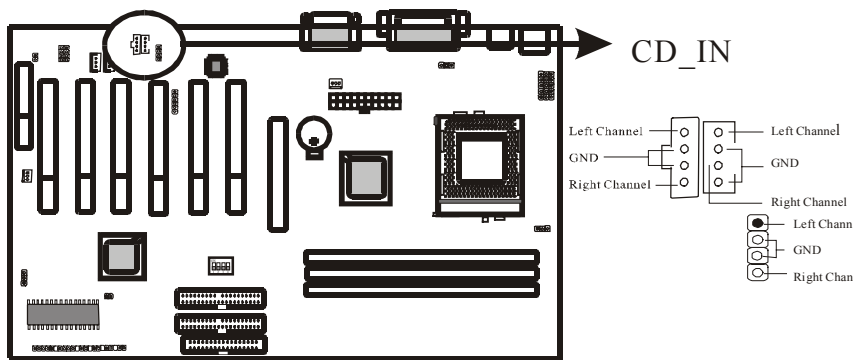

2-4 Memory

The 6AAP5 supports Double Date Rate Memory Modules (DDR). Three sockets are available for 2.5 Volt unbuffered SDRAM (Synchronous Dynamic Random Access Memory). The sizes that are supported are :4, 16, 64, 128, 256, or 512MB, memory sizes between 4MB to 3GB cab be formed this way. Refer to the picture below for the position of the DIMM slots:

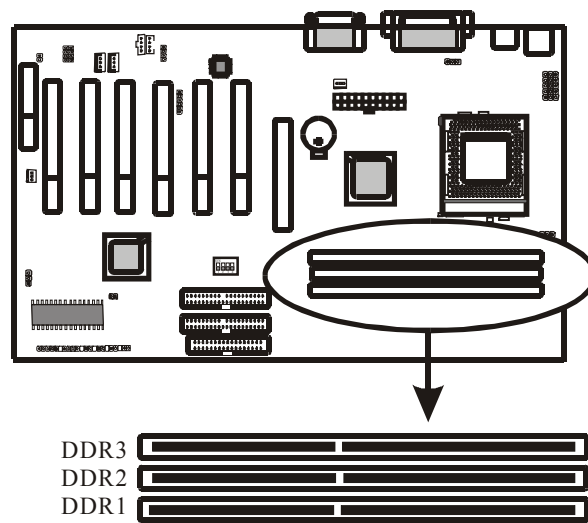

Memory speed is controlled through the BIOS, on the Advanced Chipset Features Setup page you will find several items related to SDRAM speed. Refer to the VIOS section for more details.

2-4-1 Memory Installation

The main board has 3 DDRs on board. Chipset can support maximum memory up to 3G Bytes. Insert the module as shown. Due to different number of pins on either side of the breaks, the module will only fit in the orientation as shown.

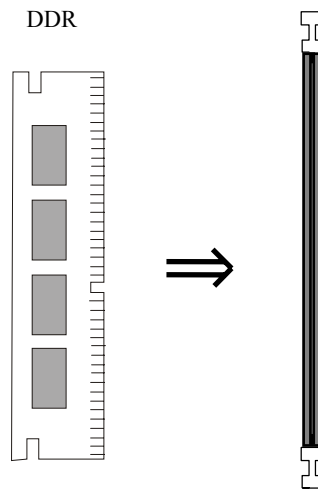

Chipset Supports DDR with 66, 100, 133 MHz.



*With 100 MHz CPUs like PII/PIII, Cyrix III, the system **MUST** be installed with PC-100 to DDR-200 memory module.*

Chapter 3 BIOS Setup

3-1 The BIOS Setup Pages

To enter the BIOS Setup pages, thke the following steps:

- Start up the system.
- After menory counting has finished, press [DEL] to enter the BIOS Setup pages.

Now the following menu will appear:

<i>CMOS SETUP UTILITY Copyright © 1984 – 2001 Award Software</i>	
<i>▶ Standard CMOS Features</i>	<i>▶ PC Health Status</i>
<i>▶ Advanced BIOS Features</i>	<i>▶ Frequency/Voltage Control</i>
<i>▶ Advanced Chipset Features</i>	<i>Load Optimized Defaults</i>
<i>▶ Integrated Peripherals</i>	<i>Set Password</i>
<i>▶ Power Management Setup</i>	<i>Save & Exit Setup</i>
<i>▶ PnP/PCI Configurations</i>	<i>Exit Without Saving</i>
<i>Esc : Quit</i>	<i>F9: Menu in BIOS</i>
<i>F10 : Save & Exit Setup</i>	<i>↑↓→← : Select Item</i>
<i>Time, Date, Hard Disk Type . . .</i>	

Selecting items

To Select items, use the following method:

- Use the arrow keys to move between items and select fields.
- Press [enter] to enter the selected submenu.

Submenus

All items that start with a ▶ are submenus. Pressing [enter] when a submenu is selected will enter that submenu.

Modifying selected items

The [Up]/[Down] keys can be used to modify values within the selected fields. Note that some fields also let you enter values directly.

Hot Keys

Throughout the BIOS Setup Pages the hot keys will give you access to a group of commands. Refer to the following table for the hot keys and their function:

Key	Command	Description
F10	Save & Exit Setup	Saves the changes made and reboots the system.
[Esc]	Quit	Returns to the previous menu
F1	Help	General Help
F2	Help	Help for specific item
F5	Previous values	Restores the previous values. These are the values that the user started the current session with.
F7	Optimized Defaults	Loads all options with the Optimized Default values.

Save & Exit Setup

When you select the [SAVE & EXIT SETUP] option from the Main Menu, all changes that you made will be saved to the CMOS memory and the setup utility will exit, rebooting your system.

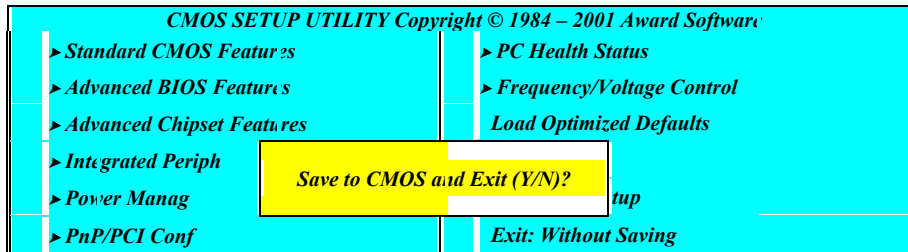

Pressing [Y] and [enter] will save the changes, pressing [N] and [enter] will keep the old settings.

Exit Without Saving

Selecting 'Exit Without Saving' will exit Setup without saving changes to CMOS.

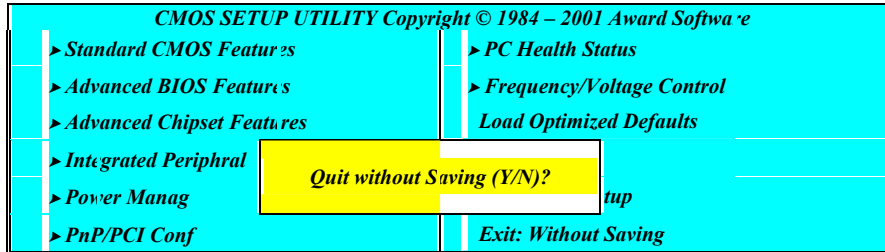

Pressing [Y] and [enter] will Exit without saving, pressing [N] and [enter] will not Exit.

3-2 Standard CMOS Setup

Select the [STANDARD CMOS SETUP] option from the Main Menu and press [Enter] key.

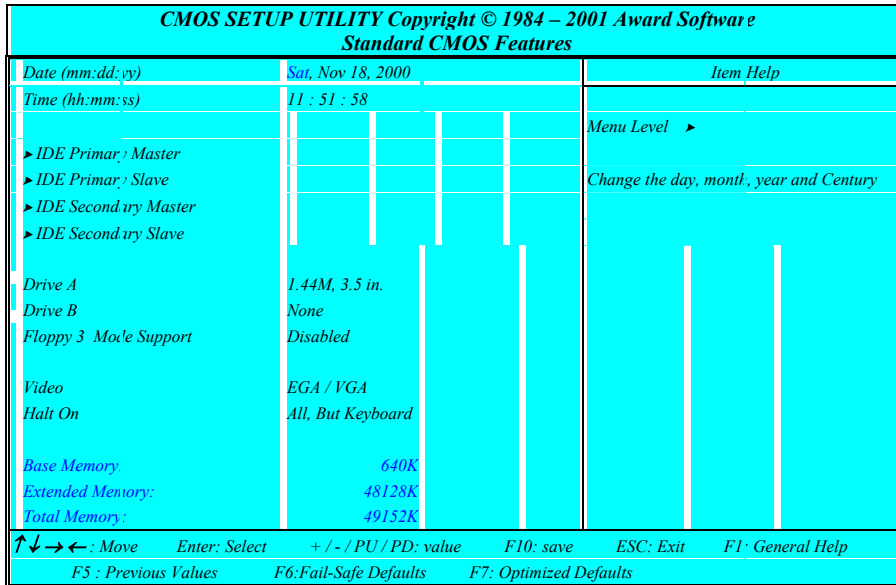

This screen allows you to change the basic CMOS Settings such as date and time, harddisk type etc. After you have made the changes you need to make press [ESC] to return to the main menu.

Date and Time

	Default	Possible Settings	Notes
Date	Weekday, month, day, year	Type the current date. (weekday auto changes)	Using the P-Up / P-Dn keys to toggle is possible
Time	hh:mm:ss	Type the current time	24-hour clock for mat. (15:15:00 = 3:15:00)

IDE Devices

When you select one of the IDE devices, a submenu will pop up. Refer to the picture below.

CMOS SETUP UTILITY Copyright © 1984 – 2001 Award Software		
IDE xxx		
IDE HDD Auto Detection	Press Enter	Item Help
IDE Primary Master	Auto	Menu Level ▶▶
Access Mode	Auto	To auto-detect the HDD's size, head... on this channel
Capacity	0 MB	
Cylinder	0	
Head	0	
Precomp	0	
Landing Zone	0	
Sector	0	

This Menu is the same for all 4 IDE devices:

- Primary Master IDE 1 first device
- Primary Slave IDE 1 second device
- Secondary Master IDE 2 first device
- Secondary Slave IDE 2 second device

	Values	Meaning
IDE HDD Auto Detection	Press Enter	Pressing Enter will make the BIOS auto detect the IDE device on this channel. The result will be displayed below, starting with the 'capacity' item. (These items are read only)
IDE xxx	Auto	This will auto detect the device at each boot up.
	Manual	This will use the setting set by the user. No auto detection at start up will take place.
	None	This setting means no device is present. This will prevent the BIOS from looking for a device and speed up booting.
Access Mode	CHS	Selects the CHS access mode.
	LBA	Logical Block Addressing, for HDD drives larger than 504MB (All modern HDDs)
	Large	For very large HDDs.
	Auto	The BIOS will automatically detect the best access mode.

Drive A and Drive B

The Drive A / B items allow you select the type of device that you have attached to the Floppy (FDD1) connector on the motherboard. You can select between

different floppy disk drive types by using the Page-Up and Page-Down keys. If you press [enter] while Drive A or B is selected the following menu will pop up that will allow to choose a device as well:

<i>Drive X</i>		
<i>None</i>	...	<input type="checkbox"/>
<i>360K, 5.25 in.</i>	...	<input type="checkbox"/>
<i>1.2M, 5.25 in.</i>	...	<input type="checkbox"/>
<i>720K, 3.5 in.</i>	...	<input type="checkbox"/>
<i>1.44M, 3.5 in.</i>	...	<input checked="" type="checkbox"/>
<i>2.88M, 3.5 in.</i>	...	<input type="checkbox"/>
<i>↑↓: Move Enter: Accept ESC: Abort</i>		

Video

The Video item allows you to select a video mode. Since most modes are outdated we advise you to always select EGA/VGA. You can select between different video modes by using the Page-Up and Page-Down keys. If you press [enter] a menu pops up.

(Mono is for a monochrome screen that can only display one color)

<i>Video</i>		
<i>EGA/VGA</i>	...	<input checked="" type="checkbox"/>
<i>CGA 40</i>	...	<input type="checkbox"/>
<i>CGA 80</i>	...	<input type="checkbox"/>
<i>MONO</i>	...	<input type="checkbox"/>
<i>↑↓: Move Enter: Accept ESC: Abort</i>		

Halt On

The BIOS will stop booting when an error is detected. You can set through this item what errors will stop the system booting. You can select between different error modes by using the Page-Up and Page-Down keys.

	Values	Meaning
<i>Halt On</i>	All Errors	Stop booting on all errors.
	No Errors	Always Boot, no matter what error is detected.
	ALL, BUT KEYBOARD	Stop booting on all errors, but not on a keyboard error.
	All, but diskette	Stop booting on all errors, but a diskette error.
	All, but disk/key	Stop booting on all errors, but keyboard and diskette errors.

3-3 BIOS Features Setup

Select the [Advanced BIOS Features] option from the Main Menu and press [Enter] key.

CMOS SETUP UTILITY Copyright © 1984 – 2001 Award Software Advanced BIOS Features		
Virus Warning	Disabled	Item Help
CPU Internal Cache	Enabled	
External Cache	Enabled	Menu Level ▶
Processor Number Geature	Enabled	
Quick Power On Self Test	Enabled	
First Boot Device	Floppy	
Second Boot Device	HDD 0	
Third Boot Device	LS 120	
Boot Other Device	Enabled	
Swap Floppy Drive	Disabled	
Boot Up Floppy Seek	Enabled	
Boot Up NumLock Status	On	
Boot Up System Speed	High	
Gate A20 Option	Fast	
Typematic Rate Setting	Disabled	
X Typematic Rate (Chars/Sec)	6	
X Typematic Delay (Msec)	250	
Security Option	Setup	
OS Select For DRAM > 64 MB	Non-OS2	
Report No F		
↑↓ → ← : Move Enter: Select + / - /PU / PD: value F10: save ESC: Exit F1: General Help F5 : Previous Values F6: Fail-Safe Defaults F7: Optimized Defaults		

The screen is not as long on your monitor. You can use the arrow keys to scroll down and up the page. The following explains all individual items and their meaning.

Virus protection

	Values	Meaning
<i>Virus Warning</i>	Enabled	The BIOS will give a beep and a warning whenever an attempt is made to write to the boot sector of the HDD.
	Disabled	The BIOS will allow write attempts to the boot sector

CPU Cache settings

	Values	Meaning
<i>CPU Internal Cache</i>	Enabled	This will enable the Internal L1 cache of your CPU.
	Disabled	(Not recommended)
<i>External Cache</i>	Enabled	This will enable the Internal L2 cache of your CPU.
	Disabled	(Not recommended)

Quick Power On Self Test

	Values	Meaning
<i>Quick Power On Self Test</i>	Enabled	The BIOS will execute test routines that test most parts of the motherboard during boot up.
	Disabled	The BIOS will skip the tests, speeding up the boot process. Errors will on the other hand not be detected.

Boot Devices

The first to third boot device items allow you to select what device the system should boot from. If the BIOS fails to boot from the first boot device, it will attempt to boot from the second boot device, if that fails too, the third boot device is tried. If you set the *boot other device* item to enabled, the BIOS will try to boot from other devices if the first to third choices all fail. If you set this item to disabled, the BIOS will not boot if the first to third devices all fail to boot.

The list you can choose from for the first to third device is the same, refer to the table below:

	Values	Meaning
<i>First ~ Third boot device</i>	Floppy	The system attempt to boot from diskette. (first boot device default)
	LS 120	The system will attempt to boot from an attached LS 120 drive. (Third boot device default)
	HDD 0	The system will attempt to boot from the first HDD. (Second boot device default)
	SCSI	The system will attempt to boot from the first device attached to the first SCSI interface.
	CD-ROM	The system will attempt to boot from the first CD-ROM found.
	HDD1	The system will attempt to boot from the second HDD.
	HDD2	The system will attempt to boot from the third HDD.
	HDD3	The system will attempt to boot from the fourth HDD.
	ZIP100	The system will attempt to boot from an attached ZIP 100 drive
	LAN	The system will attempt to boot over the network. You will require a LAN card with boot BIOS for this option to function.
	Disabled	This disables booting from this device.

Floppy Drive Settings

	Values	Meaning
<i>Swap Floppy Drive</i>	Enabled	This will swap floppy A and B. Most systems not even have 2 floppy drives, so this item is irrelevant .
	Disabled	Floppy A and B are not swapped
<i>Boot-up Floppy Seek</i>	Enabled	The BIOS will test whether the floppy has 40 or 80 tracks during boot up. All new floppy drives are 80 tracks.
	Disabled	The BIOS will not test the amount of tracks.

Keyboard Typematic Rate and Delay Settings

If you set the *typematic rate setting* item to disabled, the system will use the defaults of 6 and 250 for the rate and delay items. If you set it to enabled you can select the values yourself. Refer to the table below:

	Values	Meaning
<i>Typematic Rate</i>	6 ~ 30	This value sets the amount of time a character is repeated per second if it is kept down on the keyboard. Choose from the following values: 6, 8, 10, 12, 15, 20, 24, 30.
<i>Typematic Delay</i>	250 ~ 1000	This value sets the amount of time in ms before a character starts repeating after it was pressed on the keyboard. Choose from 250, 500, 750 and 1000 ms.

Security Option

The security option item allows you to select when the password needs to be entered. Refer to the table below:

	Values	Meaning
<i>Security Option</i>	Setup	Password must be entered only when the user wants to enter the BIOS setup.
	System	The password must always be entered at boot.

OS Select for DRAM > 64MB

	Values	Meaning
<i>OS select for DRAM > 64MB</i>	Non-OS2	If your OS is not OS2, always select this setting.
	OS2	Select this setting only if your OS is OS2

HDD SMART Capability

	Values	Meaning
<i>HDD Smart Capability</i>	Enabled	Some Harddisks support SMART, a diagnostic standard that allows the HDD to tell the system about problems. Enable this item only if your HDD supports SMART.
	Disabled	Default setting.

3-4 Chipset Features Setup

Select the [Advanced BIOS Features] option from the Main Menu and press [Enter] key.

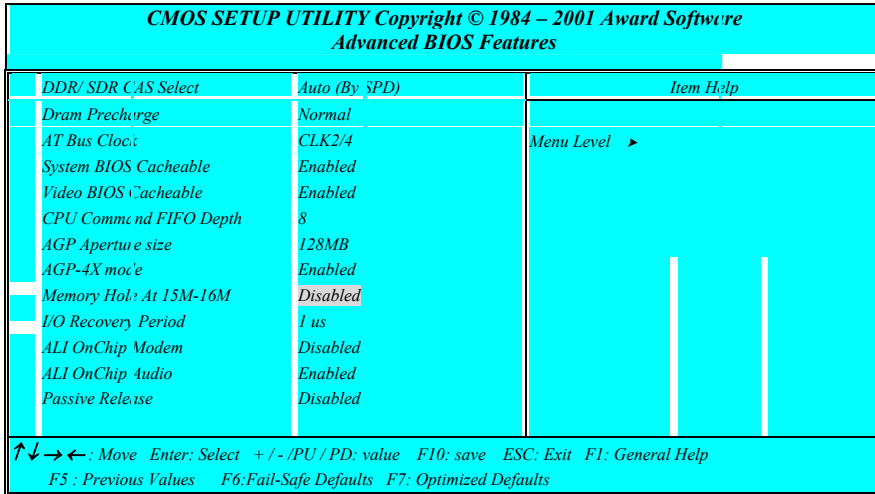

The screen is not as long on your monitor. You can use the arrow keys to scroll down and up the page. The following explains all individual items and their meaning.

AGP Settings

	Values	Meaning
AGP Aperture Size	1 – 256MB	This item allows setting of the portion of the main memory that is assigned to the AGP card. Normally about half or less of the total memory should be assigned. Choose from 4, 8, 16, 32, 64, and 128MB, default is 128MB.
AGP 4X Mode	Enabled	Set to enabled only if your AGP card supports 4x mode
	Disabled	For AGP cards that support 1x and 2x mode.

Cache Settings

The following settings are related to cacheability of video RAM and the system BIOS, change them only if you are an experienced user.

	Values	Meaning
<i>System BIOS Cacheable</i>	Enabled	This will enable caching of the system BIOS memory section. This means that BIOS code can run faster when called often.
	Disabled	This will not cache any BIOS code, meaning that BIOS code will have to be read from memory each time.

3-5 Integrated Peripherals

Select the [Integrated Peripherals] option from the Main Menu and press [Enter] key.

CMOS SETUP UTILITY Copyright © 1984 – 2001 Award Software			
Integrated Peripherals			
Onchip	Primary IDE	Enabled	Item Help
Master	PIO	Auto	
Slave	PIO	Auto	
Master	Ultra DMA	Auto	Menu Level ▶
Slave	Ultra DMA	Auto	
OnChip	Secondary IDE	Enabled	
Master	PIO	Auto	
Slave	PIO	Auto	
Master	Ultra DMA	Auto	
Slave	Ultra DMA	Auto	
On-Chip	USB Controller	Enabled	
On-Chip	USB2 Controller	Disabled	
	USB Keyboard support	Disabled	
	Init Display First	AGP	
	IDE HDD Block Mode	Enabled	
	Onboard Serial Port 1	3F8/IRQ.1	
	Onboard Serial Port 2	2F8/IRQ.1	
	Onboard Serial Port 3		
	UART Mode Select		
	RxD, TxD Active	Hi, Lo	
	IR Duplex Mode	Half	
	Fast IR Mode Use DMA	1	
	Onboard Parallel Port		
	Parallel Port Mode		
	ECP Mode Use DMA	3	

↑ ↓ → ← : Move Enter: Select +/- PU / PD: value F10: save ESC: Exit F1: General Help
 F5 : Previous Values F6:Fail-Safe Defaults F7: Optimized Defaults

The screen is not as long on your monitor. You can use the arrow keys to scroll up and down the page.

IDE Channel Settings

The following table explains IDE channel settings and what they mean:

	Values	Meaning
<i>xxx PIO</i>	Auto	The BIOS will assign a PIO mode to this device automatically when appropriate
	Mode 0	Select a PIO Mode here. PIO mode 0 is slowest, PIO mode 4 is fastest, check your HDD to see what PIO mode it supports. If your IDE device supports UDMA mode, then it best to enable that mode since it is considerably faster than PIO mode. (Set to auto for auto-detection)
	Mode 1	
	Mode 2	
	Mode 3	
Mode 4		
<i>xxx - UDMA</i>	Auto	The BIOS will automatically use Ultra DMA Mode if the IDE device supports it.
	Disabled	This will disable the use of Ultra DMA for this device.
<i>IDE HDD Block Mode</i>	Enabled	Block mode allows faster transfer of data between the system and the HDD. Most modern HDDs support it.
	Disabled	Block Mode is not used.

Display Initialization

	Values	Meaning
<i>Init Display First</i>	PCI Slot	The BIOS will first search for a VGA adapter on the PCI bus, if one is found it will be used as primary display.
	AGP	The AGP Bus is first scanned.

COM ports (Serial Ports)

	Values	Meaning
<i>Onboard serial port 1 / 2/3</i>	Auto	The bios will automatically use serial ports.
	Disabled	If you do not need the serial port in question, set this item to disabled.
	3F8/IRQ4	Set an IO address and an IRQ to be used by serial ports.
	2F8/IRQ3	
3E8/IRQ4		
2E8/IRQ3		

IR Control

	Values	Meaning
--	--------	---------

<i>UART Mode</i>	IrDA	
	ASKIR	Allows use of the IR port in ASKIR mode.
	TFD S6000	
	HSDL3600	
<i>IR Duplex Mode</i>	HSDL1100	
	Half	Select if your IR device supports Half duplex only.
	Full	For IR devices that support full duplex.

Parallel Port (Printer Port)

	Values	Meaning
<i>On board Parallel Port</i>	Disable	Disables use of the parallel port.
	3BC / IRQ7	Select an IO Address and an IRQ to be used by the parallel port.
	378 / IRQ7	
278 / IRQ5		
<i>Parallel Port Mode</i>	EPP1.9	Enables use of EPP devices.
	ECP	Enables use of EPP devices.
	ECP+ EPP 1.9	Enables use of EPP / ECP devices.
	SPD	
	EPP1.7	
<i>ECP mode use DMA</i>	ECP+EPP 1.7	
	1 or 3	Select either DMA channel 1 or 3 (This is only relevant if ECP was selected above). Default is channel 3.

3-6 Power Management Setup

Select the [Power Management Setup] option from the Main Menu and press [Enter] key.

CMOS SETUP UTILITY Copyright © 1984 – 2001 Award Software		
Power Management Setup		
ACPI Function	Enabled	Item Help
ACPI Suspend Type	S1(POS)	Menu Level ▶
Power Management	User Define	
PM Control by APM	No	
MODEM Use IRQ	3	
Video Off In Suspend	Yes	
Video Off Method	DPMS	
PM Timers		
HDD Power Down	Disabled	
Suspend Mode	Disabled	
*** PowerOn\ WakeUp Function***		
Soft-Off by FWR-BTTN	Instant-Off	
SLEEP BUTTON	Disabled	
WakeUp\ PowerOn by PCI Card	Disabled	
WakeUp\ PowerOn by Ring	Disabled	
USB Dev WakeUp From S3-S5	Enabled	
Resume by Alarm	Disabled	
X Date (of Month) Alarm	0	
X Time (hh: m n: ss) Alarm	0 : 0 : 0	
*** Suspend Break Events ***		
IRQ [1] (Keyboard)	Enabled	
IRQ [3]	Disabled	
IRQ [4]	Disabled	
IRQ [5]	Disabled	
IRQ [6] (Floppy Disk)	Enabled	
IRQ [7]	Disabled	
IRQ [8] (RTC)	Disabled	
IRQ [9]	Disabled	
IRQ [10]	Disabled	
IRQ [11]	Disabled	
IRQ [12] (PS2 Mouse)	Enabled	
IRQ [14] (Primary IDE)	Enabled	
IRQ [15] (Secondary IDE)	Disabled	
↑ ↓ → ← : Move Enter: Select PU / PD / + / - : value F10: save ESC: Exit F1: General Help F5 : Previous Values F6: Fail-Safe Defaults F7: Optimized Defaults		

ACPI Function

For a detailed description of ACPI and what it does, refer to the FAQ chapter, ACPI section. ACPI can be either enabled or disabled on this BIOS Setup page. For the ACPI Suspend type there are two options:

- S1 (POS)
- S3 (STR)

STR is the so called Suspend to RAM suspend type. This will save the system context all to RAM and it will shut down the system. The standby voltage of the power supply backs up the RAM contents. (Therefore we recommend to use a power supply that can support a current of 1A at the standby line). When the user want the system to wake up again, the system is powered up, the BIOS detects a STR and the system restores itself to where it left off. Start up time is much faster than a normal boot would take.

Power Management

Pressing [enter] when the power management item is selected will have the following sub menu appear:

Refer to the following table for an explanation of the items above:

	Values	Meaning
<i>Power Management</i>	User Define	The three items below can be set by the user
	Min Saving	The three items below are set to: disabled, 1 hour, 1hour respectively.
	Max Saving	The three items below are set to: disabled, 1 min, 1min respectively.
<i>HDD Power Down</i>	1 – 15 Min	Will power down the HDD if it is idle for the amount of minutes selected here.
	Disabled	Will not power down the HDD.
<i>Suspend Mode</i>	1 Min to 1 Hour	Selecting a time will force the system into suspend mode after being idle for that time. Choose from the following time intervals: 1, 2, 4, 6, 8, 10, 20, 30, 40 min and 1 Hour
	Disabled	The system will never enter suspend mode.

PM control

--	--	--	--

<i>PM control by APM</i>	Yes	Power Management will be done through the APM (Advanced Power Management) interface. Select this setting for Windows OSes. (Not Win NT)
	No	The BIOS will control PM directly.

Modem IRQ

<i>Modem Use IRQ</i>	NA	This disables the modem IRQ
	3 - 11	Select an IRQ line that will be assigned to your modem here. Choose from: 3 (default), 4, 5, 7, 9, 10, 11.

Video Options

<i>Video Off In Suspend</i>	Yes	
	No	
<i>Video Off Method</i>	Blank Screen	The screen will be blank (black) only.
	V/H SYNC+ Blank	The vertical and horizontal sync pulses will be stopped, and the screen will be blank.
	DPMS	If your monitor supports DPMS, it can be switched off through that.

Power Button

<i>Soft off by power button</i>	Instant-off	Switches the system off immediately when pressing the power button.
	Delay 4 Sec	This requires you to press the power button for at least 4 seconds before the system switches off.

Wake Events

When the system has entered doze or suspend mode, it can wake up through a wake event. These wake up events are triggered by interrupts that are monitored by the BIOS. If you press [Enter] when the Wake Up Events item is selected you will see the following sub menu appear:
Refer to the following table for more details:

--	--	--

<i>Date (of Month)</i>	0 - 31	Set the day of month for the system to wake up on.
<i>Time(hh:mm:ss) Alarm</i>	xx:xx:xx	Set the time (hh:mm:ss) for the system to wake up on.
<i>Primary INTR</i>	ON	You can select IRQs that allow the system to wake up in the IRQ Activity Monitoring item below.
	OFF	The IRQ Activity Monitoring item is disabled

3-7 PnP / PCI Configurations

Select the [PnP / PCI Configurations] option from the Main Menu and press [Enter] key.

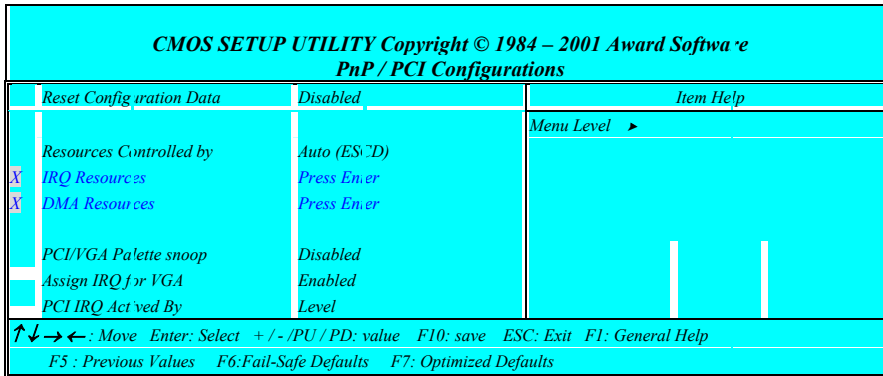

PnP Aware OS

	Values	Meaning
PnP OS Installed	No	If your OS is not capable of handling PnP (Such as Win NT) this item should be set to No.
	Yes	If your OS is PnP aware (Such as windows 95, 98, 2000 etc) set this item to Yes.

Reset Configuration Data

	Values	Meaning
Reset Configuration Data	Disabled	This will not reset the system configuration data (IRQs, DMAs) on reboot.
	Enabled	This will reset the configuration data. Remember to enable this item every time you make a change to your system (such as switching PCI cards etc).

PCI / VGA Palette Snoop

	Values	Meaning
	Disabled	Default setting.
<i>PCI / VGA Palette Snoop</i>	Enabled	This will allow the system to look at the palette the VGA uses to display. Some applications speed up with this setting but it is mostly obsolete.

Assign IRQs

	Values	Meaning
<i>Assign IRQ for VGA</i>	Enabled	This will assign an interrupt to your VGA card. Make sure to enable this item if your card needs one.
	Disabled	The BIOS will not assign an interrupt to the VGA card

3-8 PC Health Status

Select the [PC Health Status] option from the Main Menu and press [Enter] key.

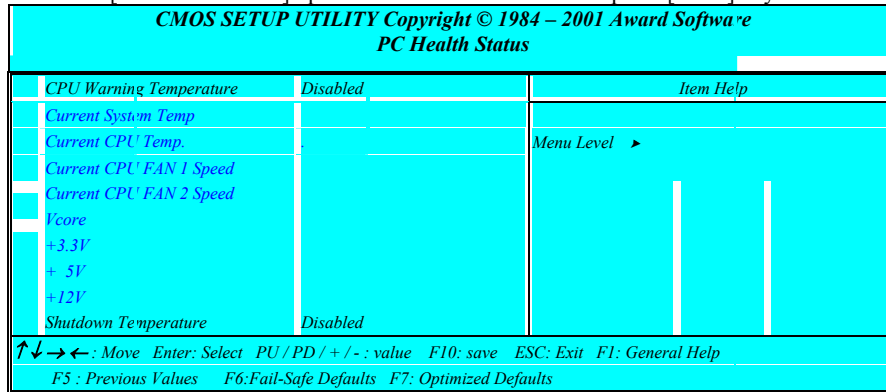

The values shown in this picture are just examples, the values shown on screen reflect the real status of your system. All items on this page are read only. A short description of each item follows:

	Meaning
Current system Temp.	This item reflects the system temperature as measured by RT2, the thermistor located close to the BIOS IC. Temperatures over 45 degrees are too high and a better cooling solution must be found for the computer case (like adding a case FAN)
Current CPU Temp.	This item reflects the CPU temperature as measured by RT1, the thermistor located under the CPU. Temperatures over 60 degrees are too high and a better cooling solution must be found for the CPU
Current CPU FAN 1 Speed	The speed of the CPU FAN connected to FAN 1 is displayed here. If you have problems with this item, please refer to the FAQ chapter boot section.
Current CPU FAN 2 Speed	The speed of the CPU FAN connected to FAN 2 is displayed here
Voltage X	The Voltage for the voltage line (Vcore, 3.3V, 5V, 12V) are displayed here. A small deviation of the ideal value is not a problem because voltages always fluctuate.

3-9 Frequency/ Voltage Control

Select the [Frequency / Voltage Control] option from the Main Menu and press [Enter] key.

CMOS SETUP UTILITY Copyright © 1984 – 2001 Award Software		
Frequency / Voltage Control		
CPU Ratio	Default	Item Help
		Menu Level ▶
↑↓→←: Move Enter: Select +/- / PU / PD: value F10: save ESC: Exit F1: General Help F5: Previous Values F6: Fail-Safe Defaults F7: Optimized Defaults		

The following table will explain the items in more detail:

	Values	Meaning
CPU Ratio	Default	
	X2.5, X3, X3.5, X4, X4.5, X5, X5.5, X6, X6.5, X7, X7.5, X8	

3-10 Passwords

The "Supervisor/User Password setting" utility sets the security protection. There are two kinds of password functions in the setup menu : one is "Supervisor Password," and the other is "User Password." Their difference is:

Supervisor Password: this function allows you the right to change the options of setup menu.

User Password: this function only allows you to enter the setup menu but not to change the options of the setup menu except "USER PASSWORD," "SAVE & EXIT SETUP," and "EXIT WITHOUT SAVING."

1. How to set "Supervisor Password" & "User Password"

Step 1: Enter Password

Press <Enter> after appointing the password.

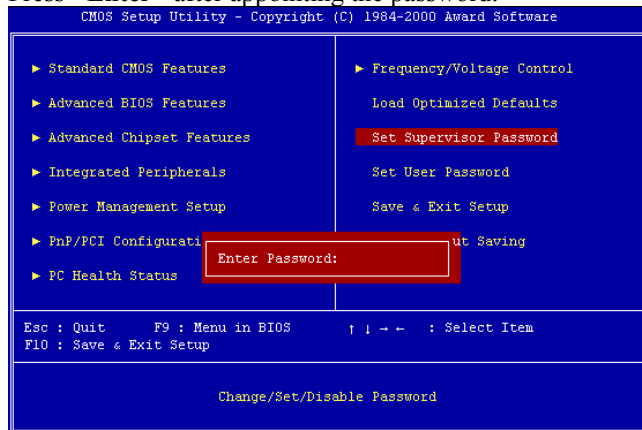

Step 2: Confirm Password

Type the password again and press <Enter> .

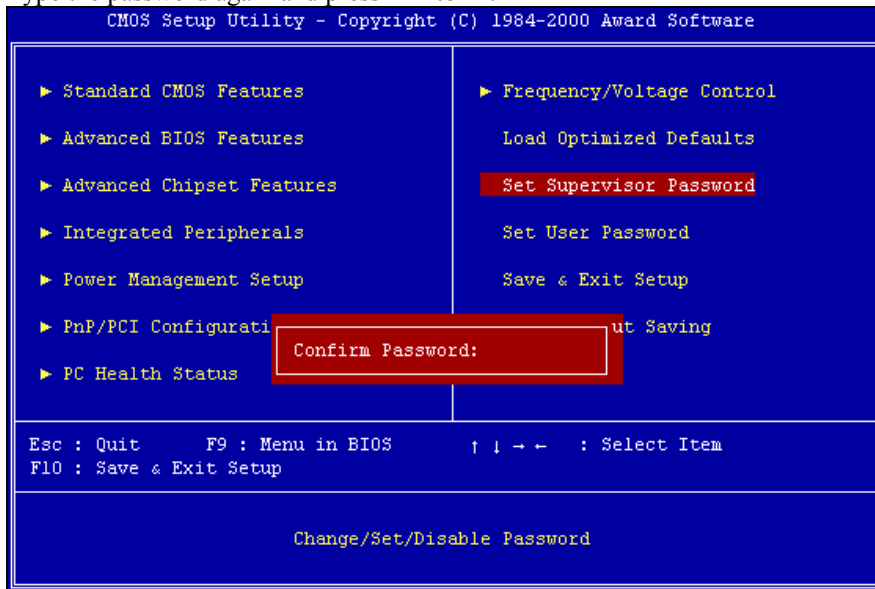

Note: If you forget password, please clear CMOS.
(refer to JBAT1 CMOS status)

Step 3: Set “Security Option” in “BIOS Features Setup”

After setting password, enter “Security Option” in “BIOS Features Setup.” There are 2 options “Setup” & “System.” “Setup” secures CMOS setup. “System” secures PC system and password is required during system boot-up and CMOS setup..

2. How to disable Password Setting

Step 1: **Go to CMOS Setup Menu** (need to key in password first)

Step 2: Enter Password Setting

When it shows “Enter Password.” Press the <Enter> key instead of entering a new password when “ENTER PASSWORD” appears. It will inform “PASSWORD DISABLED PRESS ANY KEY TO CONTINUE.” Press any key as instructed to disable password.

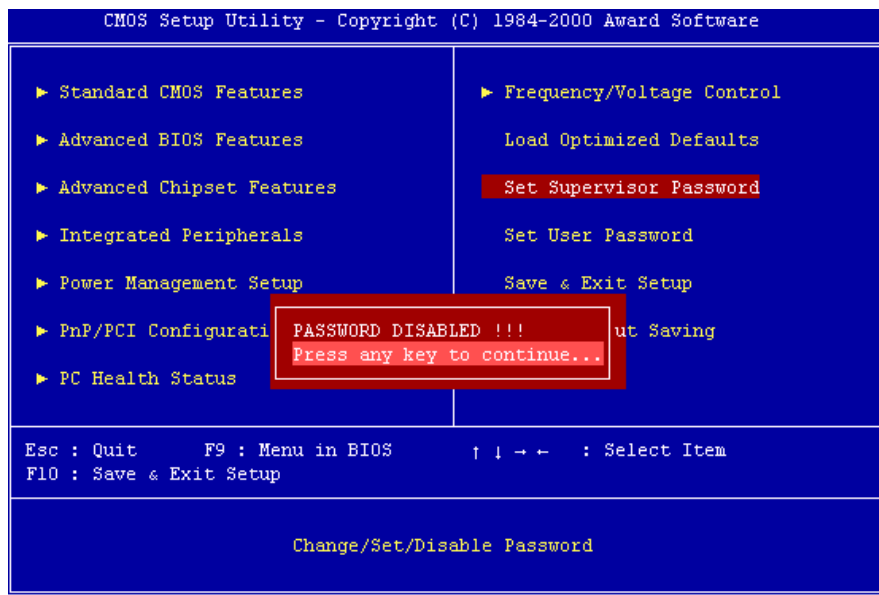

3-11 Load Optimized Defaults

"Load Optimized Defaults" loads optimized settings which are stored in the BIOS ROM. The auto-configured settings only affect "BIOS Features Setup" and "Chipset Features Setup" screens. There is no effect on the standard CMOS setup. To use this feature, highlight it on the main screen and press the <Enter> key. A line will appear on screen asking if you want to load the setup default values. Press the <Y> key and then press the <Enter> key. The setup defaults will then load. Press <N> if you don't want to

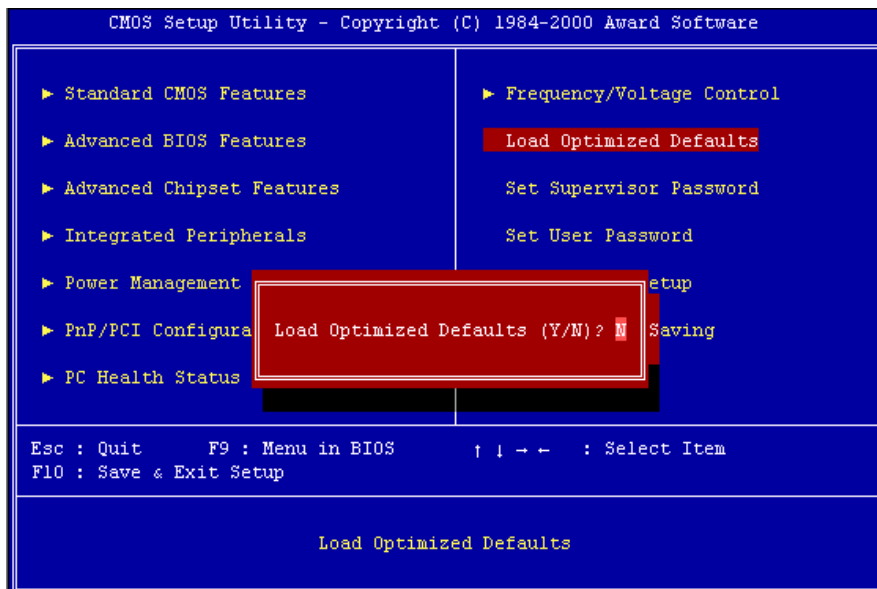

Chapter 4 Appendix

4-1 Memory Map

Address range	Size	Description
00000-7FFFF	512K	Conventional memory
80000-9FBFF	127K	Extended conventional memory
9FC00-9FFFF	1K	Extended BIOS data area if PS/2 mouse is installed
A0000-C7FFF	160K	Available for hi DOS memory
C8000-DFFFF	96K	Available for hi DOS memory and adapter ROMs
E0000-EEFFF	60K	Available for UMB
EF000-EFFFF	4K	Video service routine for monochrome & CGA adapter
F0000-F7FFF	32K	BIOS CMOS setup utility
F8000-FCFFF	20K	BIOS runtime service routine (2)
FD000-FDFFF	4K	Plug and play ESCD data area
FE000-FFFFF	8K	BIOS runtime service routine (1)

4-2 I/O Map

000-01F	DMA controller (master)
020-021	Interrupt controller (master)
022-023	Chipset control registers. I/O ports
040-05F	Timer control registers
060-06F	Keyboard interface controller (8042)
070-07F	RTC ports & CMOS I/O ports
080-09F	DMA register
0A0-0BF	Interrupt controller (slave)
0C0-0DF	DMA controller (slave)
0F0-0FF	Math coprocessor
1F0-1FB	Hard disk controller
278-27F	Parallel port 2
2B0-2DF	Graphics adapter controller
2F8-2FF	Serial port 2
360-36F	Network ports
378-37F	Parallel port 1
3B0-3BF	Monochrome & parallel port adapter
3C0-3CF	EGA adapter
3D0-CDF	CGA adapter
3F0-3F7	Floppy disk controller
3F8-3FF	Serial port-1

4-3 Time & DMA Channels Map

Time map:

Timer channel 0 system timer interrupt
Timer channel 1 DRAM refresh request
Timer channel 2 speaker tone generator

DMA channels:

DMA channel 0 available
DMA channel 1 onboard ECP (option)
DMA channel 2 floppy disk (SMC chip)
DMA channel 3 onboard ECP (default)
DMA channel 4 cascade for DMA controller 1
DMA channel 5 available
DMA channel 6 available
DMA channel 7 available

4-4 Interrupt Map

NMI: non-maskable interrupt

IRQ(H/W):

- 0 system timer interrupt from timer 0
- 1 keyboard output buffer full
- 2 cascade for IRQ 8-15
- 3 serial port2
- 4 serial port1
- 5 parallel port 2
- 6 floppy disk (SMC chip)
- 7 parallel port 1
- 8 RTC clock
- 9 available
- 10 available
- 11 available
- 12 PS/2 mouse
- 13 math coprocessor
- 14 onboard hard disk (IDE1) channel
- 15 onboard hard disk (IDE2) channel

4-5 RTC & CMOS RAM Map

RTC & CMOS :

00	seconds
01	seconds alarm
02	minutes
03	minutes alarm
04	hours
05	hours alarm
06	day of week
07	day of month
08	month
09	year
0a	status register a
0b	status register b
0c	status register c
0d	status register d
0e	diagnostic status byte
0f	shutdown byte
10	floppy disk drive type byte
12	hard disk type byte
13	reserve
14	equipment type
15	base memory low byte
16	base memory high byte
17	extension memory low byte
18	extension memory high byte
19-2d	
2e-2f	
30	Reserved for extension memory low byte
31	reserved for extension memory high byte
32	date century byte
33	information flag
34-3f	reserve
40-7f	reserved for chipset setting data

4-6 ISA I/O Address Map

I/O Address (HEX)	I/O device
000 - 01F	DMA Controller 1, 8237A-5
020 - 03F	Interrupt Controller 1, 8259A
040 - 05F	System Timer, 8254-2
060 - 06F	8042 Keyboard Controller
070 - 07F	real-time Clock/CMOS and NMI Mask
080 - 09F	DMA Page Register, 74LS612
0A0 - 0BF	Interrupt Controller 2, 8259A
0C0 - 0DF	DMA Controller 2, 8237A-5
0F0 - 0FF	i486 Math Coprocessor
1F0 - 1F8	Fixed Disk Drive Adapter
200 - 207	Game I/O
20C - 20D	Reserved
21F	Reserved
278 - 27F	Parallel Printer Port 2
2B0 - 2DF	Alternate Enhanced Graphic Adapter
2E1	GPIB Adapter 0
2E2 - 2E3	Data Acquisition Adapter 0
2F8 - 2FF	Serial Port 2 (RS-232-C)
300 - 31F	Prototype Card
360 - 363	PC Network (Low Address)
364 - 367	Reserved
368 - 36B	PC Network (High Address)
36C - 36F	Reserved
378 - 37F	Parallel Printer Port 1
380 - 38F	SDLC, Bisynchronous 2
3B0 - 3BF	Monochrome Display and Printer Adapter

I/O Address (HEX)	I/O device
390 - 393	Cluster
3A0 - 3AF	Bisynchronous 1
3C0 - 3CF	Enhanced Graphics Adapter
3D0 - 3DF	Color/Graphics Monitor Adapter
3F0 - 3F7	Diskette Drive Controller
3F8 - 3FF	Serial Port 1 (RS-232-C)
6E2 - 6E3	Data Acquisition Adapter 1
790 - 793	Cluster Adapter 1
AE2 - AE3	Data Acquisition Adapter 2
B90 - B93	Cluster Adapter 2
EE2 - EE3	Data Acquisition Adapter 3
1390 - 1393	Cluster Adapter 3
22E1	GPIB Adapter 1
2390 - 2393	Cluster Adapter 4
42E1	GPIB Adapter 2
62E1	GPIB Adapter 3
82E1	GPIB Adapter 4
A2E1	GPIB Adapter 5
C2E1	GPIB Adapter 6
E2E1	GPIB Adapter 7

Chapter 5 Q & A

5-1 Errors Messages During Power On Self Test

During **power on self test (post)**, BIOS will automatically detect the system devices. Below is the question that users most often meet. The user may press “**Esc**” key to skip the full memory test.

1. Beep sound

On power on, the system make beep sound to offer different messages. If the system is configured correctly, it prompts a short beep to show device configuration is done correctly. When VGA card and DIMM modules are not plugged well, the system makes longer and constant beep sounds.

2. BIOS ROM checksum error

It indicates the checksum of the BIOS code is not right and system will always halt on power on screen. Contact the dealer to exchange a new BIOS.

3. CMOS battery fails

It indicates the CMOS battery does not work. Contact the dealer to exchange a new battery.

4. CMOS checksum error

It indicates the CMOS checksum is incorrect. Load the default values in BIOS to solve this problem. This error may result from a weak BIOS, so exchange a new BIOS if necessary.

5. Hard disk initialize

Please wait a moment...

Some hard drives require more time to initialize.

6. *Hard disk install failure*

The system can not find or initialize the hard drive controller or the drive. Check if the controller is set correctly. If no hard disk is installed, "**Hard drive selection**" must be set to "**none.**"

7. *Keyboard error or no keyboard present*

This means the system can not initialize the keyboard. Check if the keyboard is plugged well and be sure no keys are pressed during power on self test.

8. *Memory test fails*

There will be more information to specify the type and location of the memory error.

9. *Primary master hard disk fail*

The BIOS find an error in the primary master hard disk drive.

10. *Primary slave hard disk fail*

The BIOS finds an error in the primary slave hard disk drive.

11. *Secondary master hard disk fail*

The BIOS finds an error in the secondary slave master hard disk drive.

12. *Secondary slave hard disk fail*

The BIOS finds an error in the secondary slave IDE hard disk drive.

