

COMPAQ

Quick Troubleshooting Guide

Compaq Deskpro Family of Personal Computers

Compaq Deskpro Workstations

Compaq Professional Workstations

Compaq Armada Notebooks

Compaq Prosignia Notebooks

Notice

The information in this guide is subject to change without notice.

COMPAQ COMPUTER CORPORATION SHALL NOT BE LIABLE FOR TECHNICAL OR EDITORIAL ERRORS OR OMISSIONS CONTAINED HEREIN; NOR FOR INCIDENTAL OR CONSEQUENTIAL DAMAGES RESULTING FROM THE FURNISHING, PERFORMANCE, OR USE OF THIS MATERIAL.

This guide contains information protected by copyright. No part of this guide may be photocopied or reproduced in any form without prior written consent from Compaq Computer Corporation.

© 2000 Compaq Computer Corporation.
All rights reserved. Printed in the U.S.A.

COMPAQ, the Compaq Logo, and Deskpro Registered in the U. S. Patent and Trademark Office. *PREMIER•SOUND* is a trademark of Compaq Computer Corporation.

Microsoft, MS-DOS, Windows, Windows NT, and other names of Microsoft products referenced herein are trademarks or registered trademarks of Microsoft Corporation.

Intel and Pentium are registered trademarks of Intel Corporation. Celeron and MMX are trademarks of Intel Corporation.

Product names mentioned herein may be trademarks and/or registered trademarks of their respective companies.

The software described in this guide is furnished under a license agreement or nondisclosure agreement. The software may be used or copied only in accordance with the terms of the agreement.

Quick Troubleshooting Guide

Compaq Deskpro Family of Personal Computers

Compaq Deskpro Workstations

Compaq Professional Workstations

Compaq Armada Notebooks

Compaq Prosignia Notebooks

Second Edition (July 2000)
Part Number 120205-002

Compaq Computer Corporation

CONTENTS

chapter 1

General Service Information

Troubleshooting Procedures	1-1
Tools Required - Desktop Computers and Workstations.....	1-1
Tools Required - Notebooks	1-1
Protecting Yourself and the Computer.....	1-1
Clearing CMOS	1-2
Customer Responsibilities.....	1-2
POST Power-On Sequence	1-3
Compaq Drive Protection System.....	1-3
Accessing DPS Through Compaq Diagnostics for Windows	1-4
Compaq Configuration Record Utility.....	1-4

chapter 2

Troubleshooting Flowcharts for Desktop Computers

1. Initial Troubleshooting.....	2-2
2. No Power, Part 1	2-3
3. No Power, Part 2	2-4
4. No Power, Part 3	2-5
5. No Video, Part 1	2-6
6. No Video, Part 2	2-7
7. No Video, Part 3	2-8
8. Error Messages Part 1	2-9
9. Error Messages, Part 2	2-10
10. Error Messages, Part 3	2-11
11. No O/S Loading	2-12
12. No O/S Loading from Hard Drive, Part 1	2-13
13. No O/S Loading from Hard Drive, Part 2.....	2-14
14. No O/S Loading from Hard Drive, Part 3.....	2-15
15. No O/S Loading from Diskette Drive	2-16
16. No O/S Loading from CD-ROM Drive	2-17
17. No O/S Loading from Network	2-18
18. Non-Functioning Device.....	2-19

chapter 3

Troubleshooting Flowcharts for Portable Computers

1. Initial Troubleshooting.....	3-2
2. No Power, Part 1	3-3
3. No Power, Part 2	3-4
4. No Power, Part 3	3-5
5. No Power, Part 4	3-6
6. No Video, Part 1	3-7
7. No Video, Part 2	3-8
8. Non-Functioning Docking Station.....	3-9
9. No O/S Loading	3-10
10. No O/S Loading from Hard Drive, Part 1	3-11

11. No O/S Loading from Hard Drive, Part 2	3-12
12. No O/S Loading from Hard Drive, Part 3	3-13
13. No O/S Loading from Diskette Drive	3-14
14. No O/S Loading from CD-ROM or DVD-ROM Drive	3-15
15. No Audio, Part 1	3-16
16. No Audio, Part 2	3-17
17. Non-Functioning Device.....	3-18
18. Non-Functioning Pointing Device or Keyboard	3-19
19. No Network or Modem Connection.....	3-20

appendix A

Further Troubleshooting	A-1
--------------------------------------	-----

appendix B

POST Error Messages - Numbered	B-1
---	-----

appendix C

Post Error Messages - Not Numbered	C-1
---	-----

chapter 1

GENERAL SERVICE INFORMATION

The information in this book was prepared for the Compaq Deskpro 2000 Series of Personal Computers with MMX technologies and later models as well as Compaq Deskpro Workstations, Compaq Professional Workstations, Compaq Armada Notebooks, and Compaq Prosignia Notebooks.

 Not all features are available on all Compaq products.

Troubleshooting Procedures

The flowcharts listed in Chapters 2 and 3 use the building-block concept, where flowchart 1 is the first flowchart to which you should refer. If, during the debug process, you find yourself in a bind, refer back to flowchart 1 to determine which potential problems you can rule out.

Tools Required - Desktop Computers and Workstations

- Torx T-15 and flat-blade screwdrivers
- Loopback plugs
- Write-protected bootable diskette
- Anti-static wrist strap

Tools Required - Notebooks

- Magnetic flat-blade screwdriver, Torx T-8, and T-10 screwdrivers
- 3/16-inch and 7-mm hex sockets or nut drivers
- Security wrench
- Loopback plugs
- Write-protected bootable diskette
- Anti-static wrist strap

Protecting Yourself and the Computer

- Turn the computer off before disconnecting or installing any cables.
- When the computer is connected to an AC power source there is always voltage applied to the system board. You must disconnect the power cord from the power source before opening the computer to prevent system board or component damage.
- For personal safety and to ensure that the computer does not overheat, Compaq recommends that you install the computer cover or access panel before turning on the computer.

- The screws used in the computer are of different thread sizes and lengths; using the wrong screw in an application may damage the unit.
- All data stored on a hard drive is lost when the drive is formatted.

Clearing CMOS

 This procedure does not apply to portable computers.

1. Turn off the computer and any peripheral devices that are connected to it.
2. Disconnect the power cord from the electrical outlet and then from the computer.



CAUTION: The cooling fan is off only when the computer is turned off and the power cable has been disconnected. The cooling fan is always on in all other instances, such as when the computer is “On,” in “Standby,” or “Suspend” mode.



CAUTION: When the computer is connected to an AC power source there is always voltage applied to the system board. You must disconnect the power cord from the power source before opening the computer to prevent system board or component damage.

3. Remove the computer cover.
4. Reset the computer by one of the following methods depending on the model.
 - If the system board has a CMOS reset button, press the button and then release it to reset the CMOS.
 - If the system board uses jumpers, remove the E50 jumper from pins 1 and 2 for 60 seconds; then replace the jumper.

Customer Responsibilities

Check the service contract and verify that the customer has taken care of these items:

- Installing the operating system.
- Providing and running all virus check programs.
- Running Diagnostics on the hard drive.
- Reloading the operating system as required.
- Copying over the operating system files as required.
- Reformatting the hard drive as required.

POST Power-On Sequence

When a Compaq Personal Computer or workstation is turned on, the computer reads its first instructions from memory. It finds the instructions from the power-on restart vector addressed in ROM and begins executing those instructions. The instructions begin with a series of ROM-resident diagnostic tests called the Power-On Self-Test (POST) to determine if the computer is operational and ready to accept an operating system. The normal checking procedure for POST includes:

1. BIOS memory is tested and initialized (the first 128K of RAM is not displayed). If the system does not pass the first memory check, an immediate error message is displayed and the initialization process stops. The cause of a failure at this stage might be a problem with the ROM, the system board, the CPU, or memory.
2. The system board and bus devices are quick-tested to determine if the interrupt controllers, DMA controllers, keyboard controller, video display controller, interval timers, diskette drive controller, serial and parallel port controller, and fixed disk controller are all properly installed and are functioning properly.
3. The remaining memory is tested and the count displayed on the monitor only when starting the machine from the off mode. You should verify that the memory displayed corresponds with the memory installed in the computer.
4. The keyboard, drives, and their controllers are initialized and tested. Test results are shown via the LEDs on the keyboard and computer case.
5. CMOS memory is checked for configuration, time, and date. If the CMOS memory parameters do not match the actual system configuration, a "162-System Options" error or a "System CMOS" error will be displayed with instructions for restarting the computer.
6. The speaker will sound two short beeps or will display the Compaq splash screen when the POST has been successfully completed. Refer to the POST error messages when error messages are displayed on the screen or when beep patterns are sounded.

Compaq Drive Protection System

The Compaq Drive Protection System (DPS) is a diagnostic tool built into the hard drives installed in select Compaq Deskpro computers and workstations. DPS is designed to help diagnose problems that might result in unwarranted hard drive replacement.

When Compaq Deskpro Computers and workstations are built, each installed hard drive is tested using DPS and a permanent record of key information is written onto the drive. Each time DPS is run, test results are written to the hard drive. This information may be used to help diagnose the hard drive and the computer system.

Running DPS will not affect any programs or data stored on the hard drive. The test resides in the hard drive firmware and can be executed even if the computer will not boot to an operating system. The time required to execute the test depends on the manufacturer and size of the hard drive; in most cases, the test will take approximately 2 minutes per gigabyte.

DPS should be used when you suspect a hard drive problem. If the computer reports a SMART Hard Drive Detect Imminent Failure message, there is no need to run DPS; instead, back up the information on the hard drive and replace the hard drive.

Accessing DPS Through Compaq Diagnostics for Windows

To access DPS through Compaq Diagnostics for Windows, perform the following steps:

1. Turn on the computer and select My Computer→Control Panel→Compaq Diagnostics.
A choice of five possible headings appears in the Diagnostics screen: Overview, Test, Status, Log, and Error.
2. Select Test→Type of Test
A choice of three tests appear: Quick Test, Complete Test, and Custom Test.
3. Select Custom Test.
A choice of two test modes is offered: Interactive Mode and Unattended Mode.
4. Select Interactive Test→Storage→Hard Drives.
5. Select the specific drive(s) to be tested→Drive Protection System Test→Begin Testing.

When the test has been completed, one of three messages will be displayed for each of the drives tested:

- Test Succeeded. Completion Code 0.
- Test Aborted. Completion Code 1 or 2.
- Test Failed. Drive Replacement Recommended. Completion Code 3 through 14.

If the test failed, the completion code should be recorded for help in diagnosing the computer problem.

Compaq Configuration Record Utility

Compaq Configuration Record Utility is an online information-gathering tool similar to other Compaq management tools that run on computers. It gathers critical hardware and software information from various sources to give a complete view of the computer. Configuration Record Utility delivers comprehensive configuration capture, provides a means for automatically identifying and comparing configuration changes, and has the ability to maintain a computer configuration history. The information can be saved as a history of multiple sessions.

This utility was developed to allow resolution of problems without taking the computer off-line and to assist in maximizing computer availability. The information obtained by the utility is useful in troubleshooting computer problems, and streamlines the service process by enabling quick and easy identification of computer configurations, which is the first step in resolving service cases.

The Compaq Configuration Record Utility is accessed via an icon in the Control Panel. When running the utility, information is automatically gathered on such items as the operating system version number, operating system parameters, and the operating system startup files. The utility then combines this information with information on the hardware configuration to deliver a comprehensive view of the computer.

chapter 2

TROUBLESHOOTING FLOWCHARTS FOR DESKTOP COMPUTERS

1. Initial Troubleshooting, **2-2**
2. No Power, Part 1, **2-3**
3. No Power, Part 2, **2-4**
4. No Power, Part 3, **2-5**
5. No Video, Part 1, **2-6**
6. No Video, Part 2, **2-7**
7. No Video, Part 3, **2-8**
8. Error Messages, Part 1, **2-9**
9. Error Messages, Part 2, **2-10**
10. Error Messages, Part 3, **2-11**
11. No O/S Loading, **2-12**
12. No O/S Loading from Hard Drive, Part 1, **2-13**
13. No O/S Loading from Hard Drive, Part 2, **2-14**
14. No O/S Loading from Hard Drive, Part 3, **2-15**
15. No O/S Loading from Diskette Drive, **2-16**
16. No O/S Loading from CD-ROM Drive , **2-17**
17. No O/S Loading from Network, **2-18**
18. Non-Functioning Device, **2-19**

1. Initial Troubleshooting

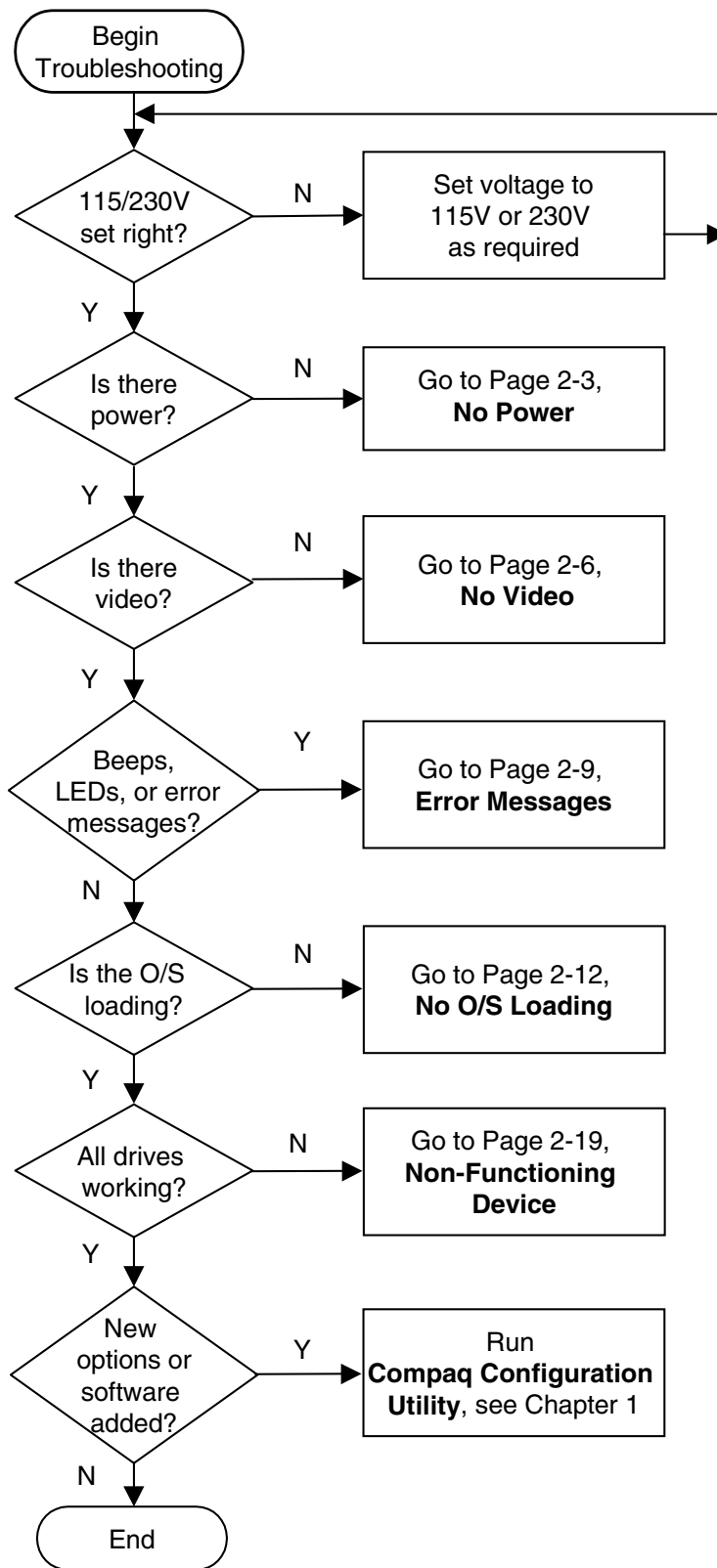

2. No Power, Part 1

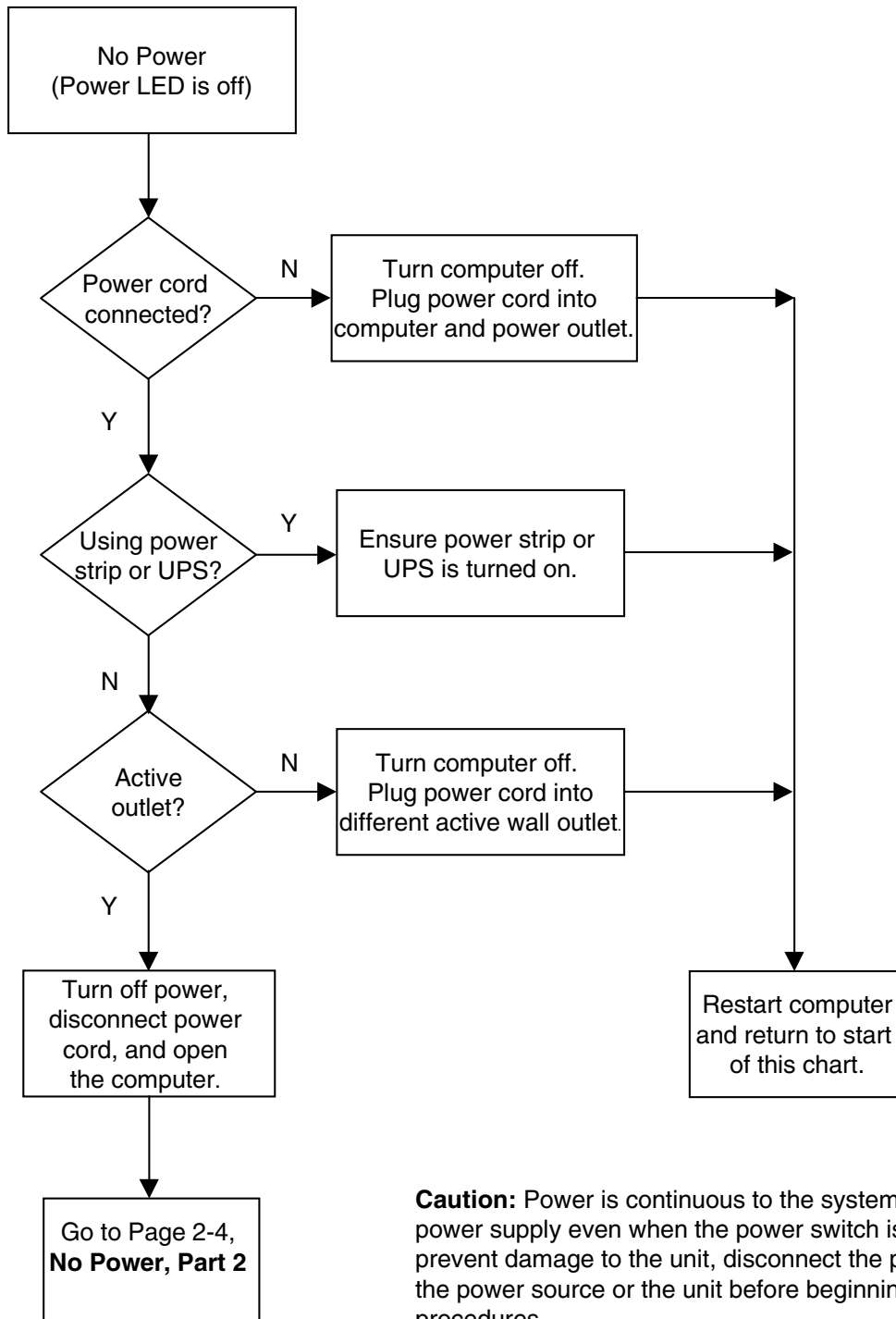

Caution: Power is continuous to the system board and power supply even when the power switch is turned off. To prevent damage to the unit, disconnect the power cord from the power source or the unit before beginning disassembly procedures.

3. No Power, Part 2

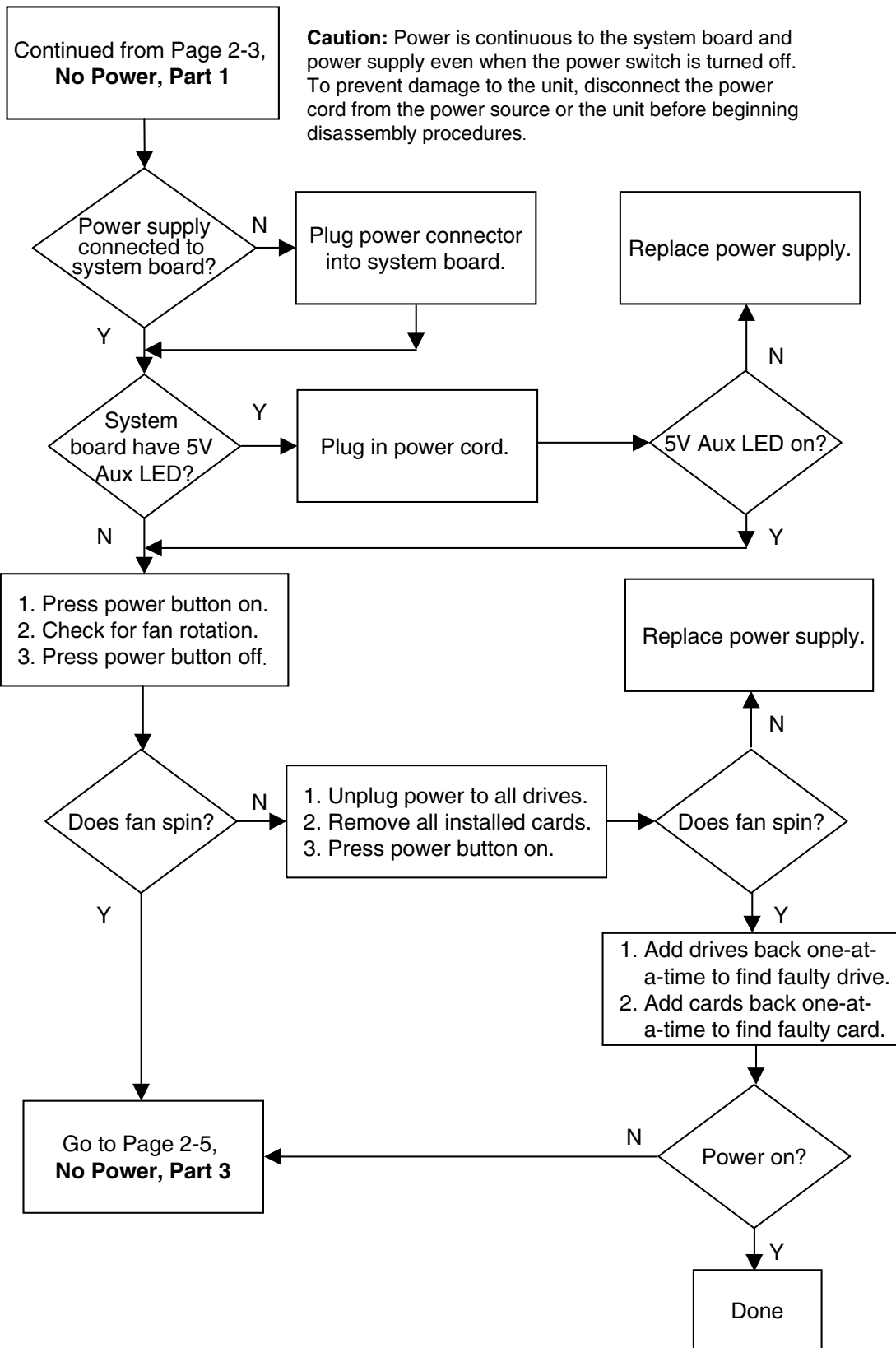

4. No Power, Part 3

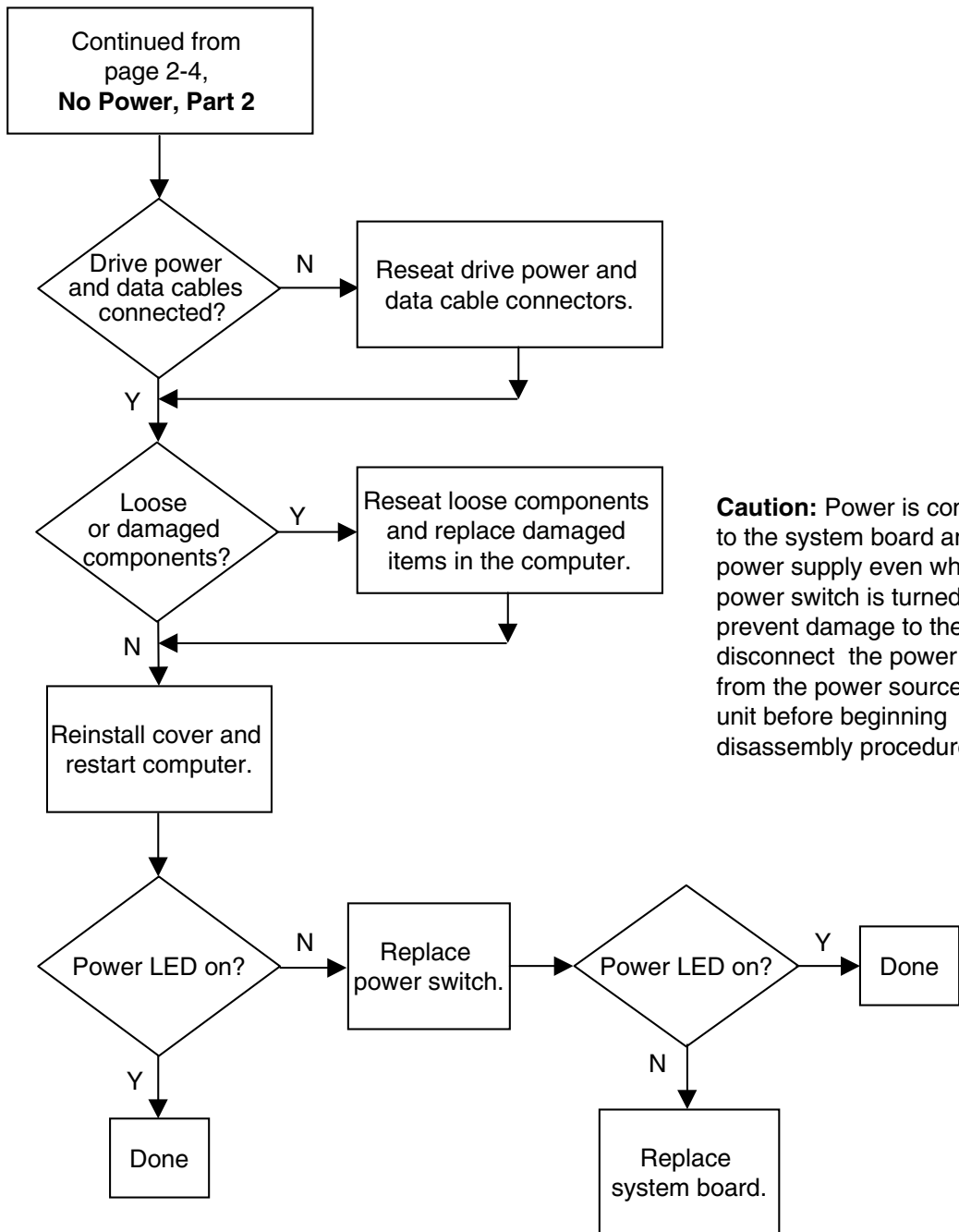

Caution: Power is continuous to the system board and the power supply even when the power switch is turned off. To prevent damage to the unit, disconnect the power cord from the power source or the unit before beginning disassembly procedures.

5. No Video, Part 1

Caution: Power is continuous to the system board and power supply even when the power switch is turned off. To prevent damage to the unit, disconnect the power cord from the power source or the unit before beginning disassembly procedures.

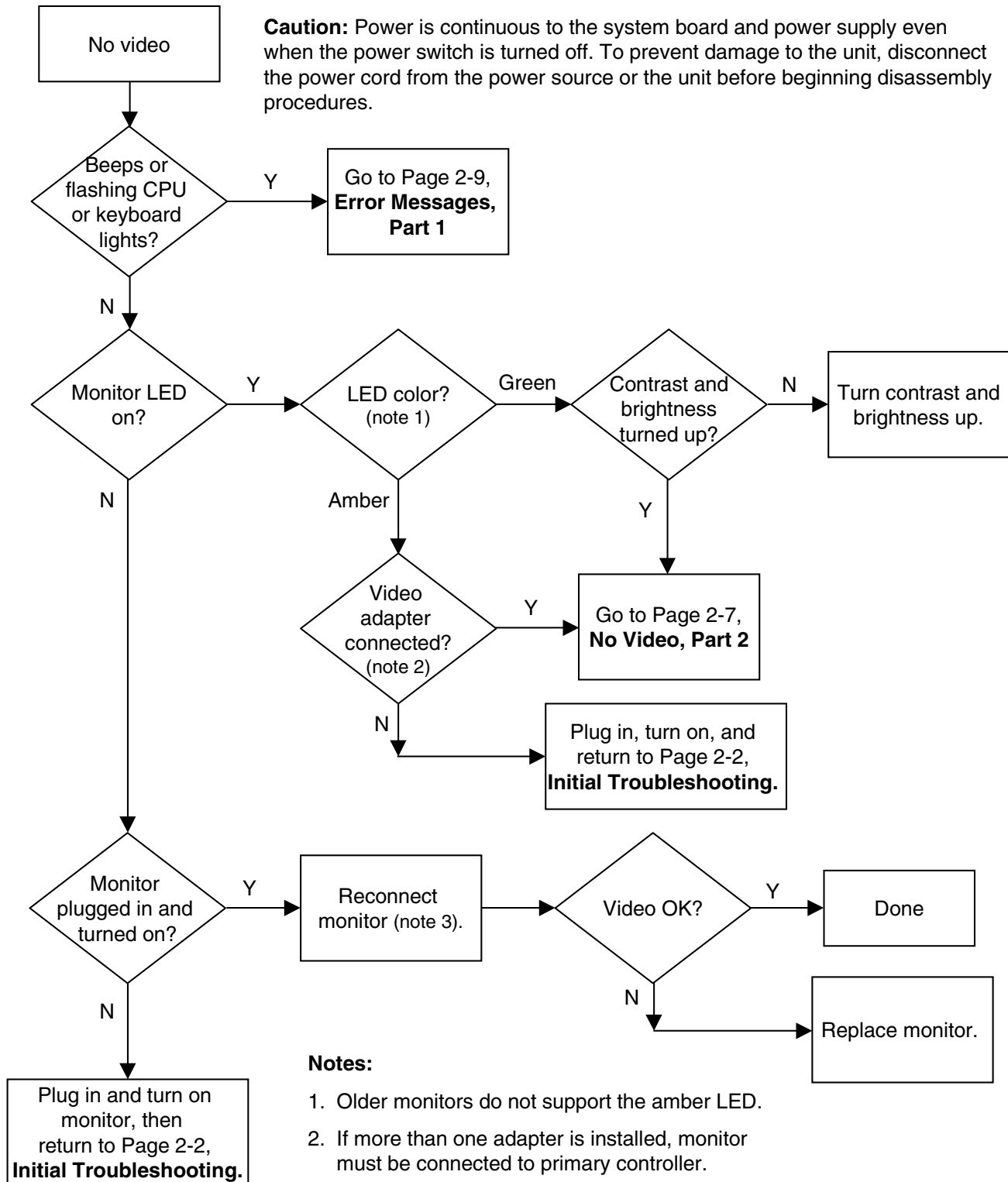

Notes:

1. Older monitors do not support the amber LED.
2. If more than one adapter is installed, monitor must be connected to primary controller.
3. Turn off and unplug computer before reconnecting cables.

6. No Video, Part 2

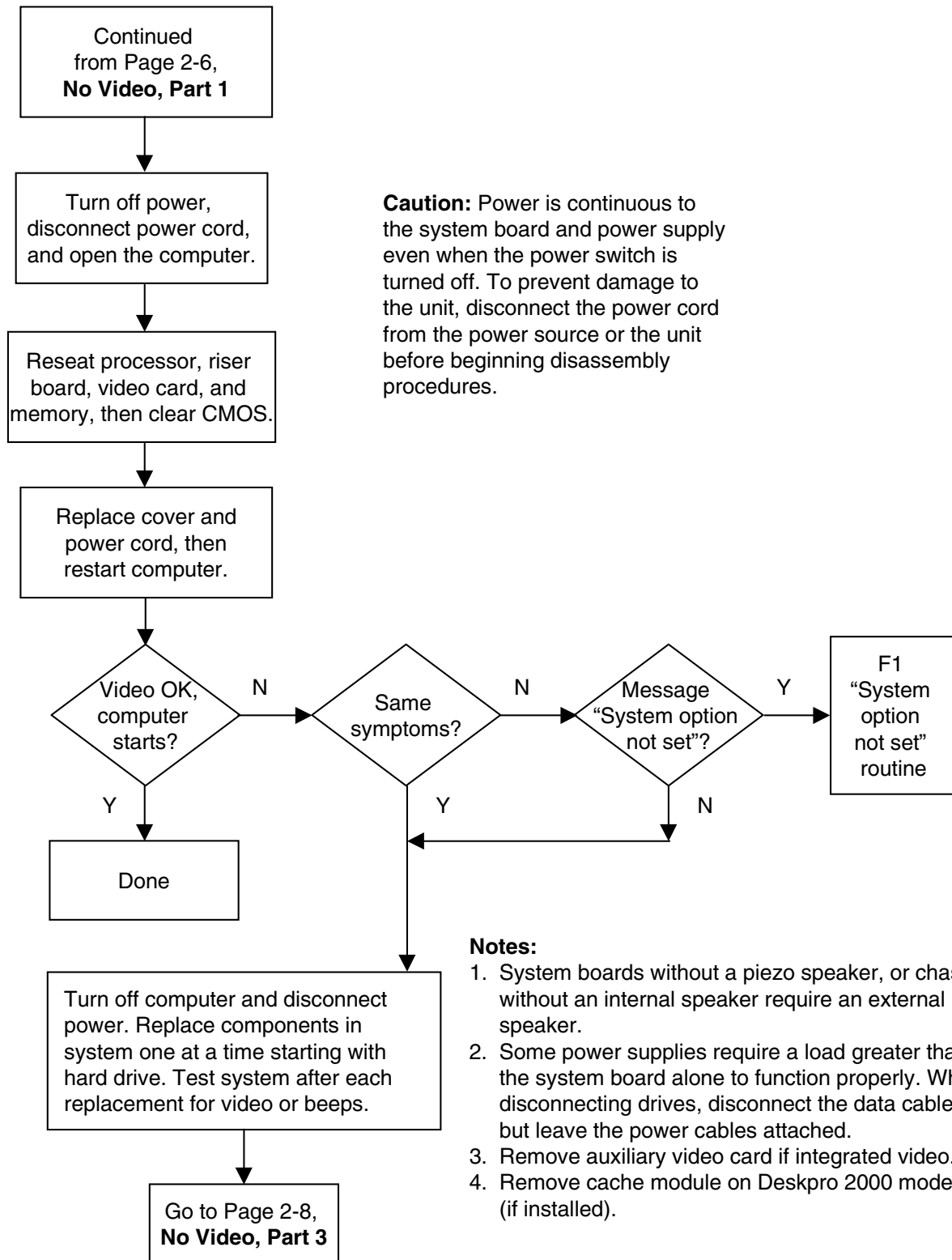

7. No Video, Part 3

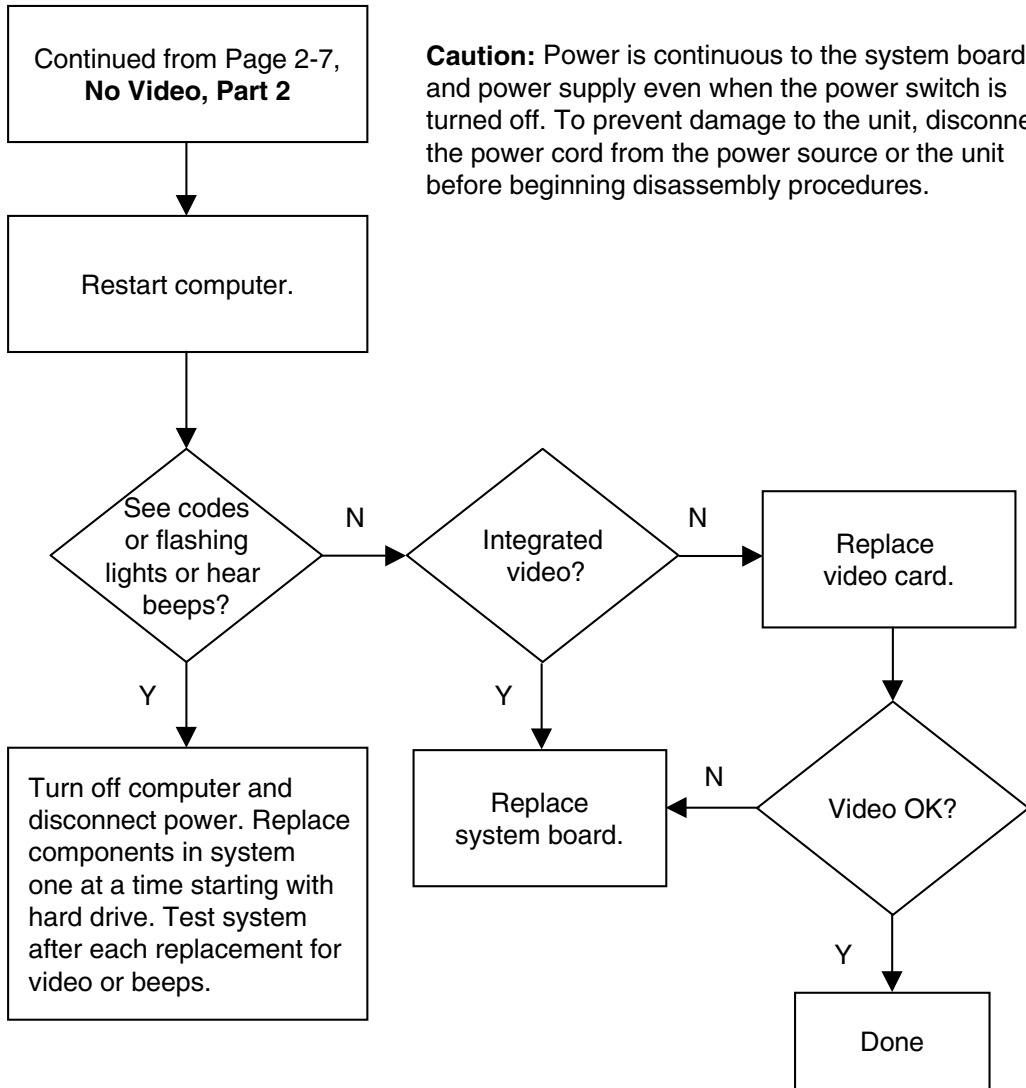

Caution: Power is continuous to the system board and power supply even when the power switch is turned off. To prevent damage to the unit, disconnect the power cord from the power source or the unit before beginning disassembly procedures.

8. Error Messages, Part 1

Beeps,
CPU or Keyboard Lights,
or POST error messages.

Caution: Power is continuous to the system board and power supply even when the power switch is turned off. To prevent damage to the unit, disconnect the power cord from the power source or the unit before beginning disassembly procedures.

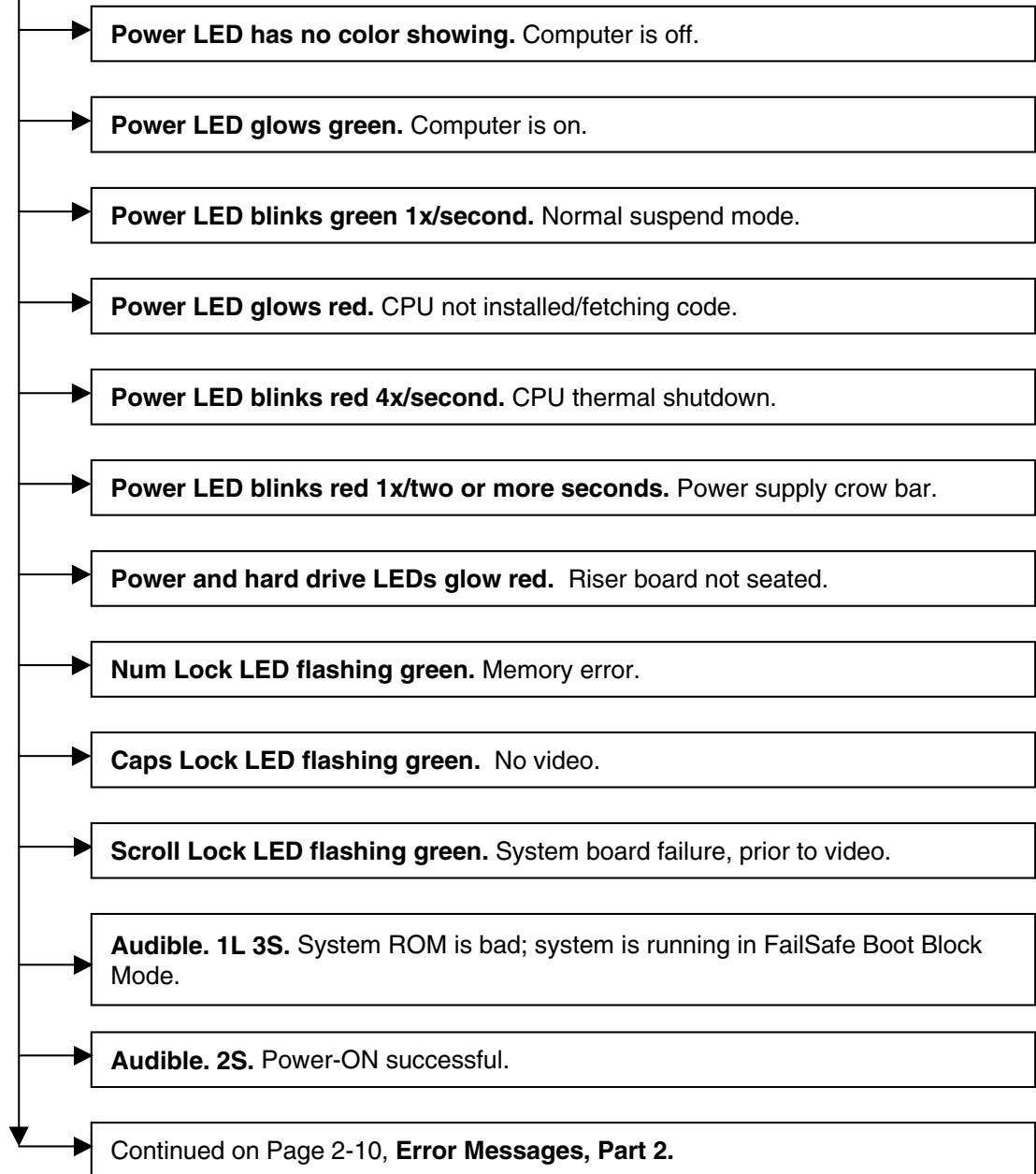

Notes: Short (S) and long (L) beeps will only be heard if the system has a speaker.
LEDs will only function on PS/2 keyboards, not USB.

9. Error Messages, Part 2

Continued from Page 2-9,
Error Messages, Part 1

Caution: Power is continuous to the system board and power supply even when the power switch is turned off. To prevent damage to the unit, disconnect the power cord from the power source or the unit before beginning disassembly procedures.

1S 2L. Num Lock blinking. System memory not present or incompatible. Unplug, open computer, and check memory modules. Ensure memory modules are correct type and that they match in size and speed.

1L 2S. Cap Lock blinking. Video controller not present or incorrectly initialized. Ensure monitor is plugged in. Unplug, open computer, and check video card. Reseat card and ensure it is in the proper expansion slot.

1L 3S. All keyboard LEDs blinking. ROM Failure. Create ROMPaq diskette and reload ROM. Download ROMPaq from Compaq website at www.compaq.com.

2L 1S. Scroll Lock blinking. System HW failure prior to video. Unplug, open computer, and check for physical damage. Ensure all cables and cards are seated. Look for burn marks or smoke.

No beeps. HD and Power LED blinking. Riser not detected. Unplug, open computer, and check and reseat riser board.

Continued on Page 2-11, **Error Messages, Part 3.**

Notes: Short (S) and long (L) beeps will only be heard if the system has a speaker.
LEDs will only function on PS/2 keyboards, not USB.

10. Error Messages, Part 3

Continued from
Page 2-10,
Error Messages, Part 2

Caution: Power is continuous to the system board and power supply even when the power switch is turned off. To prevent damage to the unit, disconnect the power cord from the power source or the unit before beginning disassembly procedures.

Error 162, 2S Beeps. System Option not set. Select F1. If error occurs after reboot, unplug and open computer and check CMOS jumper setting.

Error 163. Time & Date Not Set. Set time and date in F10 or boot to O/S and set time and date. If error occurs after reboot, unplug and open computer, then check CMOS setting.

Error 2xx. Memory Error. See **Appendix B** for specific definitions. Unplug, open computer, and reseat memory modules. Ensure modules are correct type and that they match in size and speed.

Error 30x. Keyboard Error. See **Appendix B** for specific definitions. Do not type on keyboard before POST. Ensure keyboard connected to proper connector.

Error 6xx. Floppy Error. See **Appendix B** for specific definitions. Unplug, open computer, check diskette drive, and check and reseat power and data cables.

Error 91x. Misc. Connection Error. See **Appendix B** for specific definitions. Unplug, open computer, and check hood lock coil, thermal sensor pigtail, and riser for good connection.

Error 178x. Fixed Disk Error. See **Appendix B** for specific definitions. Unplug, open computer, check hard drive, and check and reseat power and data cables.

Error 1800. Thermal Alert. System overheating. Let computer cool off. Ensure processor has heatsink installed and that speed setting on system board is correct. Remove obstructions to air vents.

All other POST error messages - refer to **Appendix B** for definitions and solutions.

Notes: Short (S) and long (L) beeps will only be heard if the system has a speaker.
LEDs will only function on PS/2 keyboards, not USB.

x = Numbers 1 - 9

11. No O/S Loading

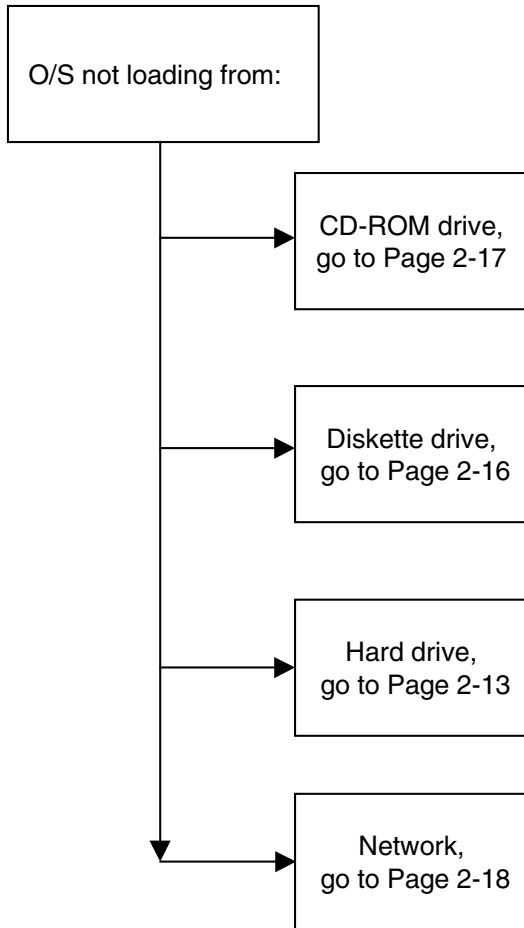

Factory recommended booting priority

1. CD-ROM drive
2. Diskette drive
3. Hard drive
4. Network

NOTE: Before beginning, always check drive jumpers, cable connections, cable ends, and drives for bent or damaged pins.

12. No O/S Loading from Hard Drive, Part 1

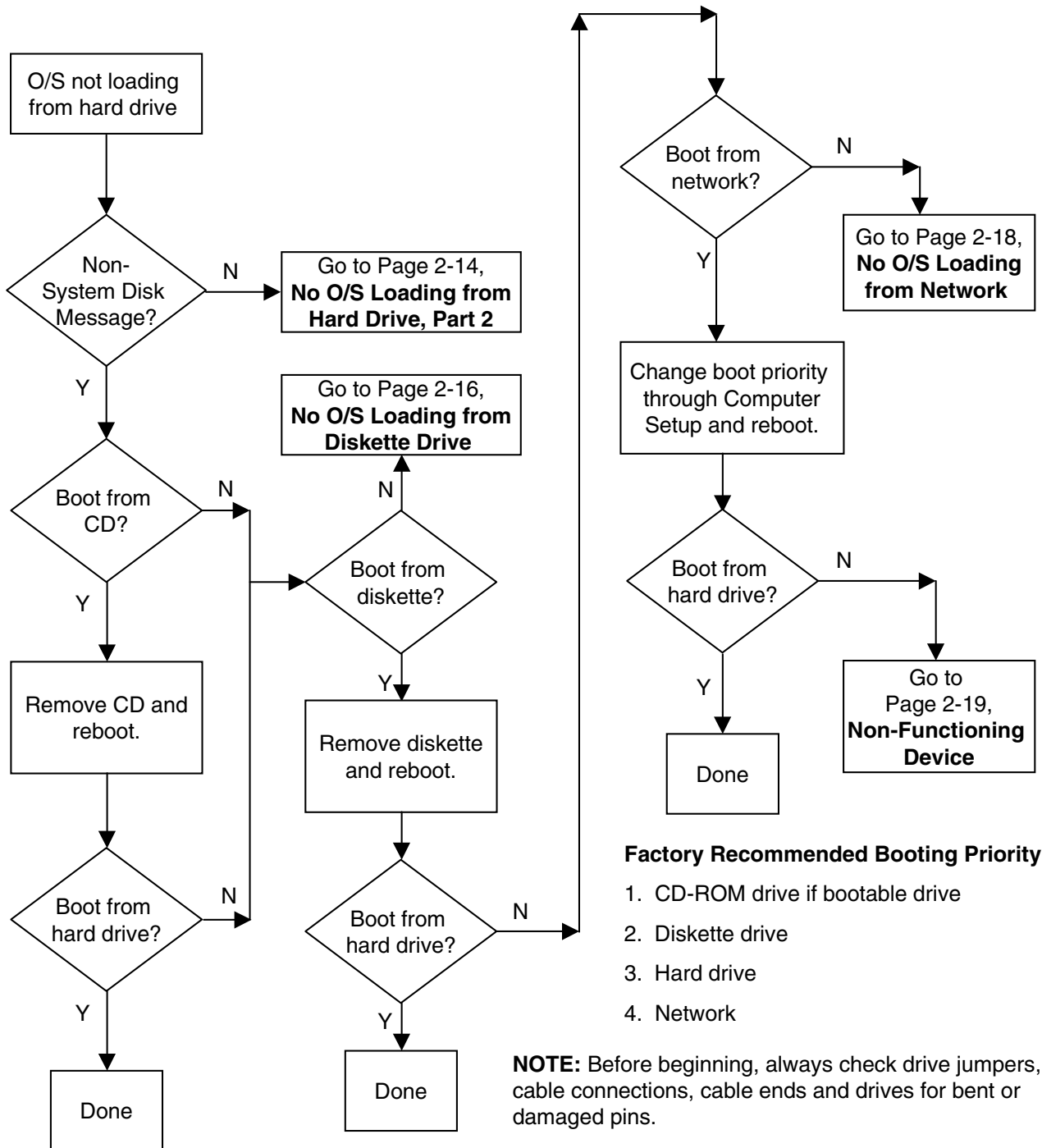

13. No O/S Loading from Hard Drive, Part 2

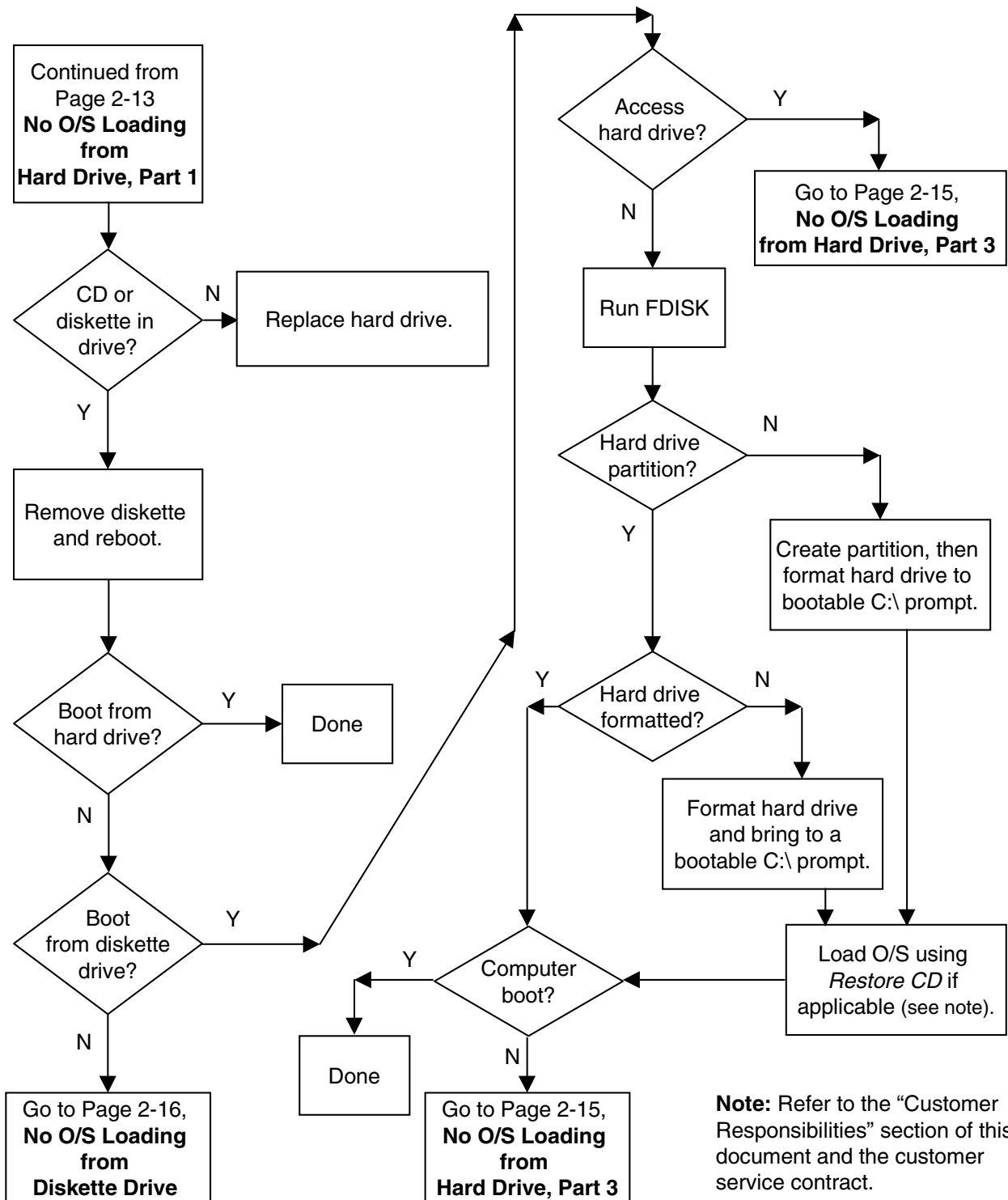

14. No O/S Loading from Hard Drive, Part 3

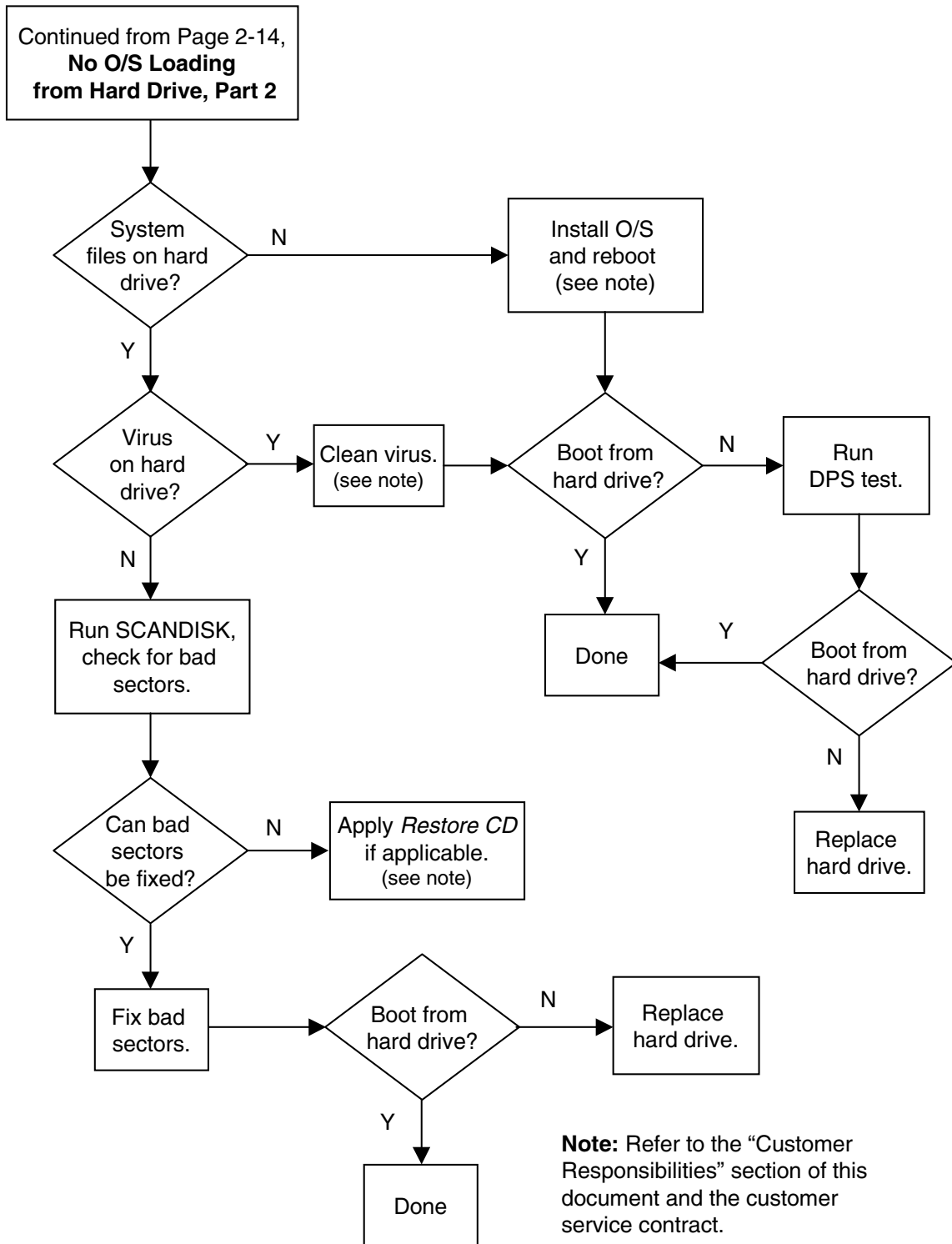

15. No O/S Loading from Diskette Drive

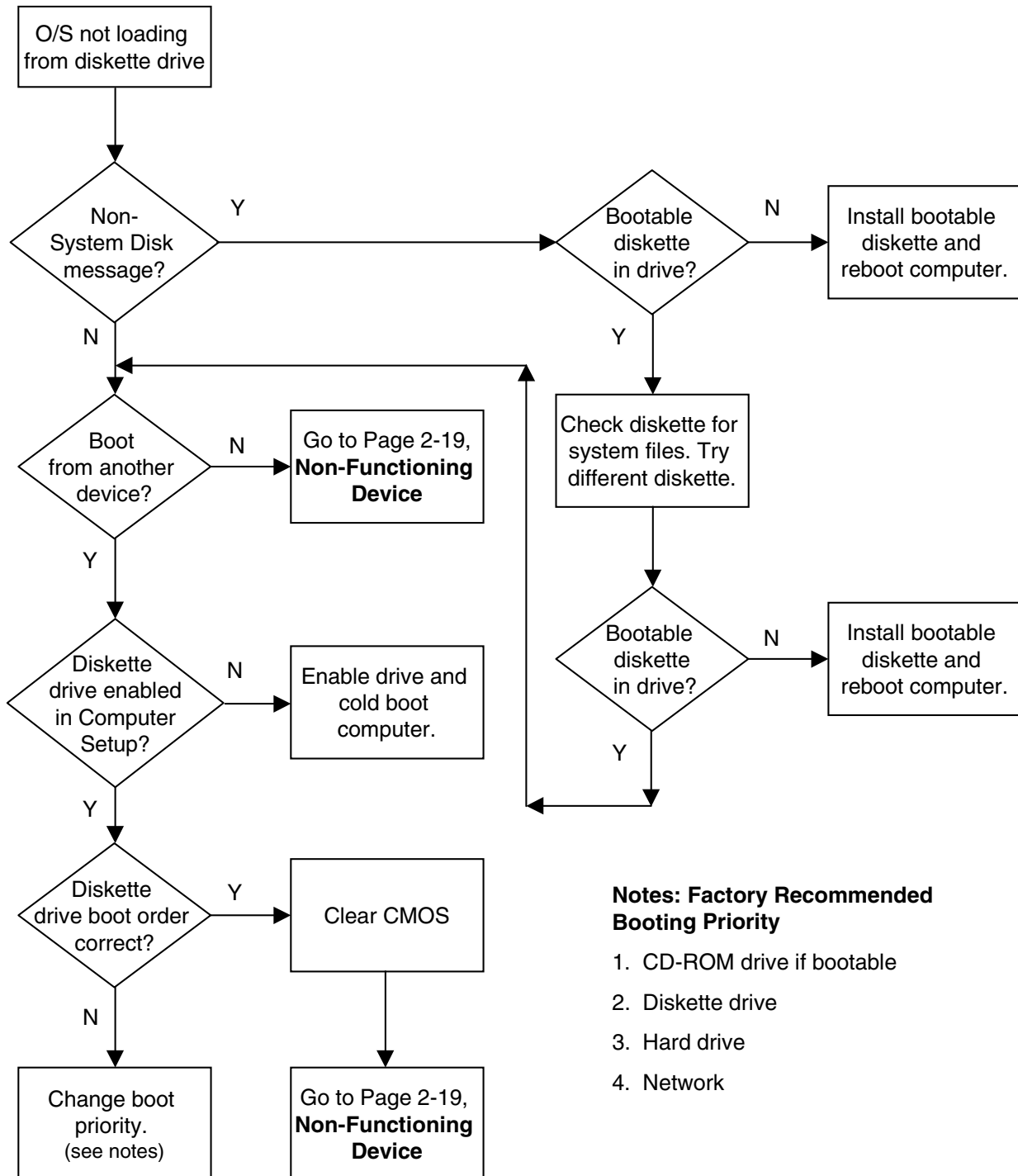

Notes: Factory Recommended Booting Priority

1. CD-ROM drive if bootable
2. Diskette drive
3. Hard drive
4. Network

16. No O/S Loading from CD-ROM Drive

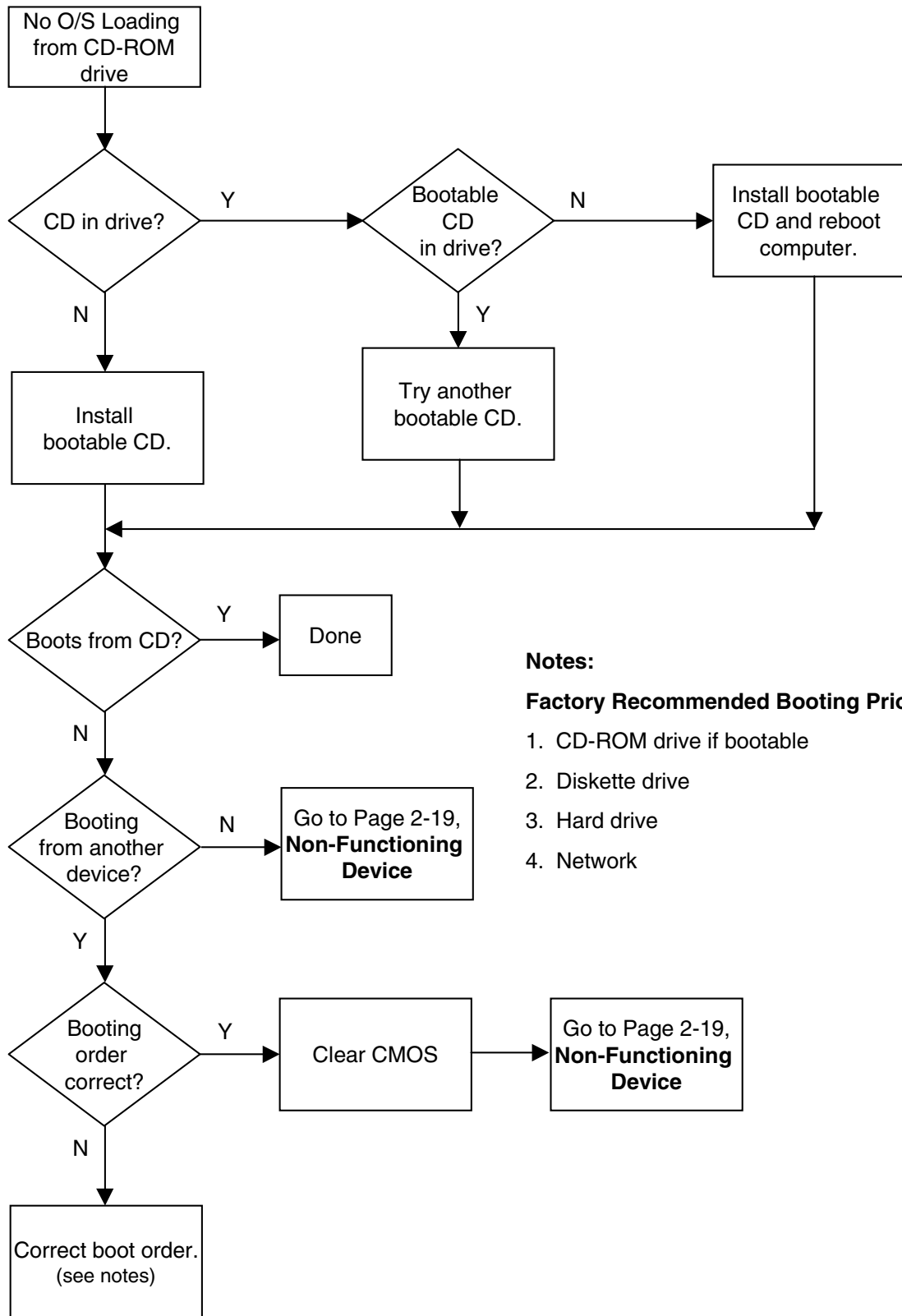

Notes:

Factory Recommended Booting Priority

1. CD-ROM drive if bootable
2. Diskette drive
3. Hard drive
4. Network

17. No O/S Loading from Network

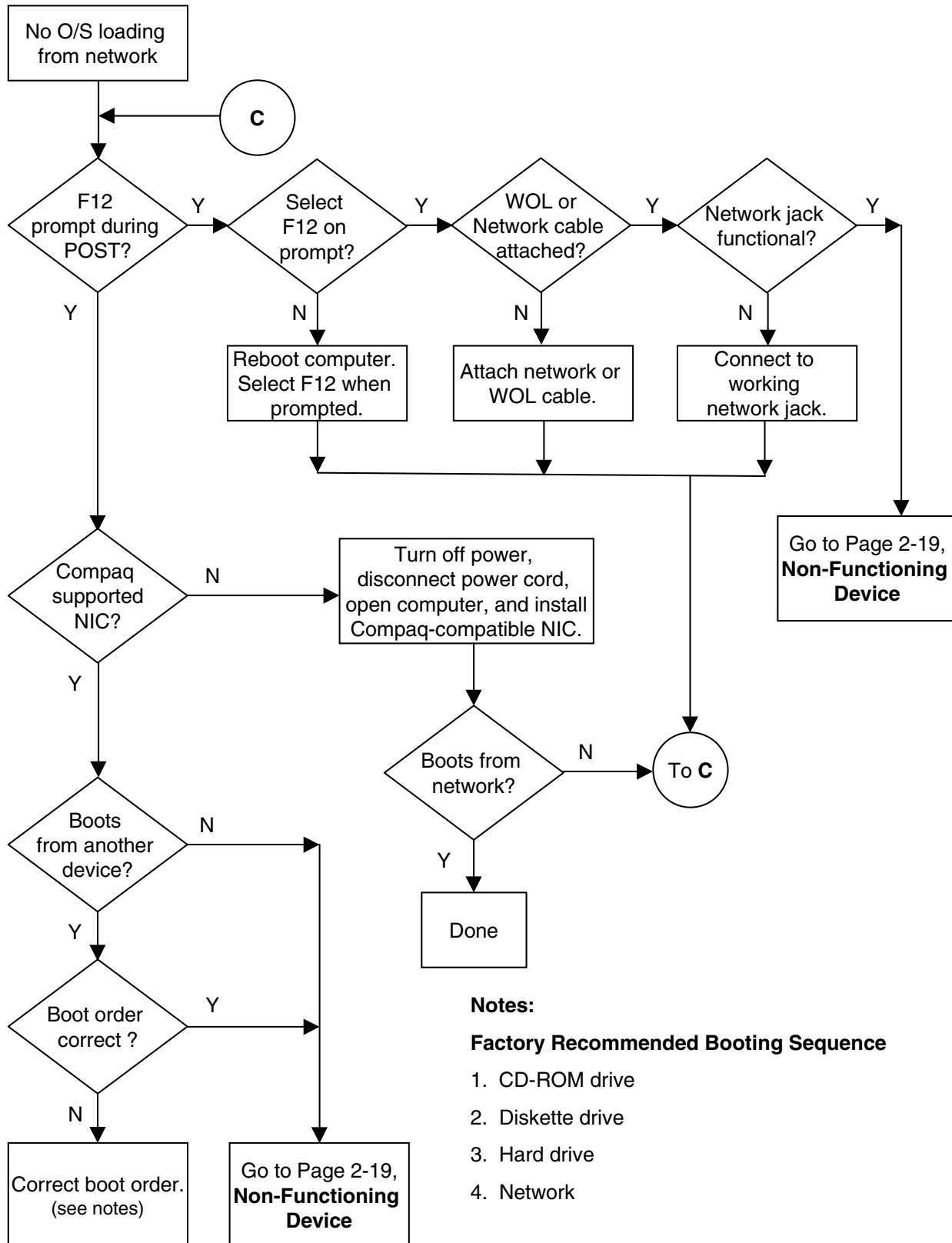

18. Non-Functioning Device

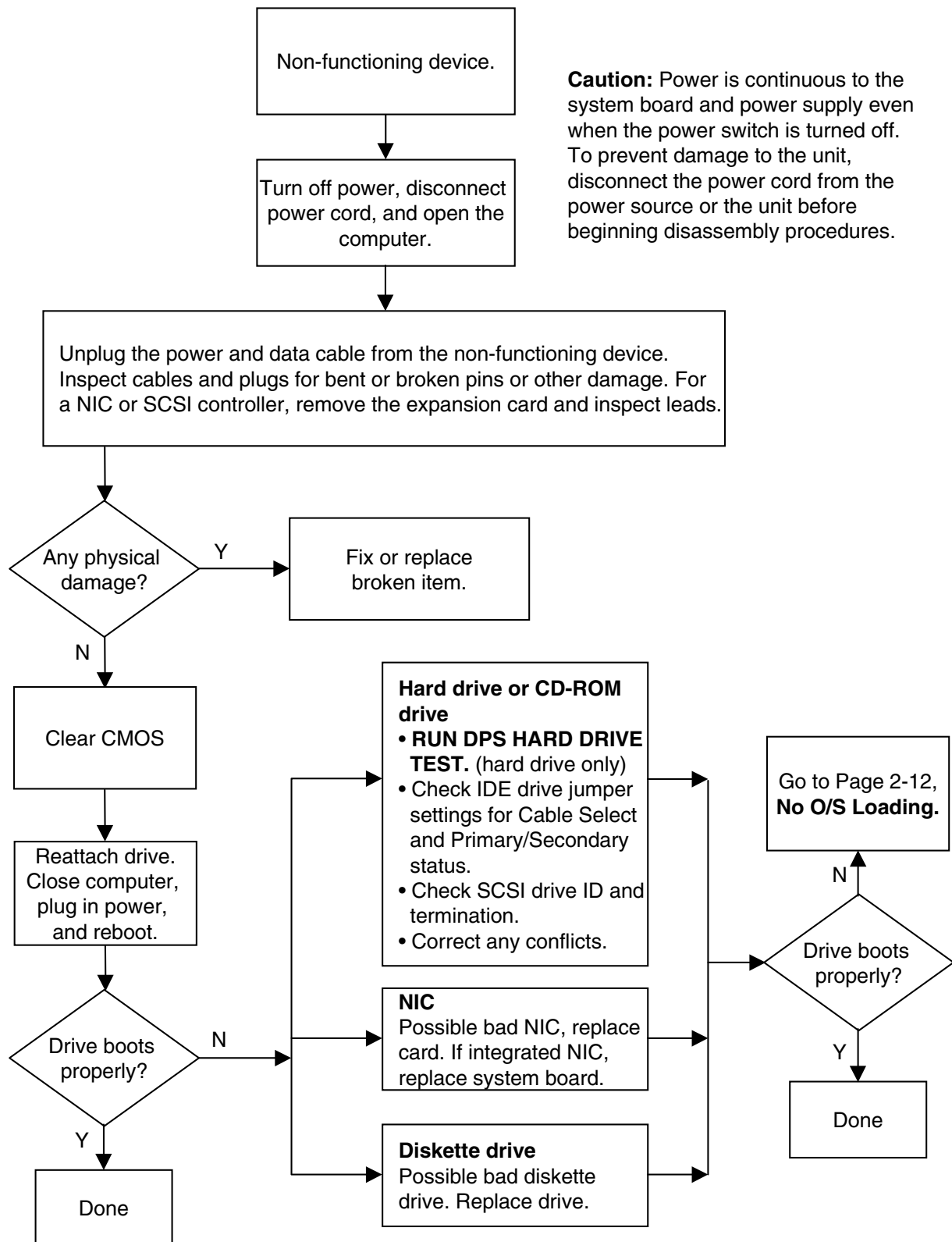

chapter 3

TROUBLESHOOTING FLOWCHARTS FOR PORTABLE COMPUTERS

1. Initial Troubleshooting, **3-2**
2. No Power, Part 1, **3-3**
3. No Power, Part 2, **3-4**
4. No Power, Part 3, **3-5**
5. No Power, Part 4, **3-6**
6. No Video, Part 1, **3-7**
7. No Video, Part 2, **3-8**
8. Non-Functioning Docking Station, **3-9**
9. No O/S Loading, **3-10**
10. No O/S Loading from Hard Drive, Part 1, **3-11**
11. No O/S Loading from Hard Drive, Part 2, **3-12**
12. No O/S Loading from Hard Drive, Part 3, **3-13**
13. No O/S Loading from Diskette Drive, **3-14**
14. No O/S Loading from CD-ROM or DVD-ROM Drive, **3-15**
15. No Audio, Part 1, **3-16**
16. No Audio, Part 2, **3-17**
17. Non-Functioning Device, **3-18**
18. Non-Functioning Pointing Device or Keyboard, **3-19**
19. No Network or Modem Connection, **3-20**

1. Initial Troubleshooting

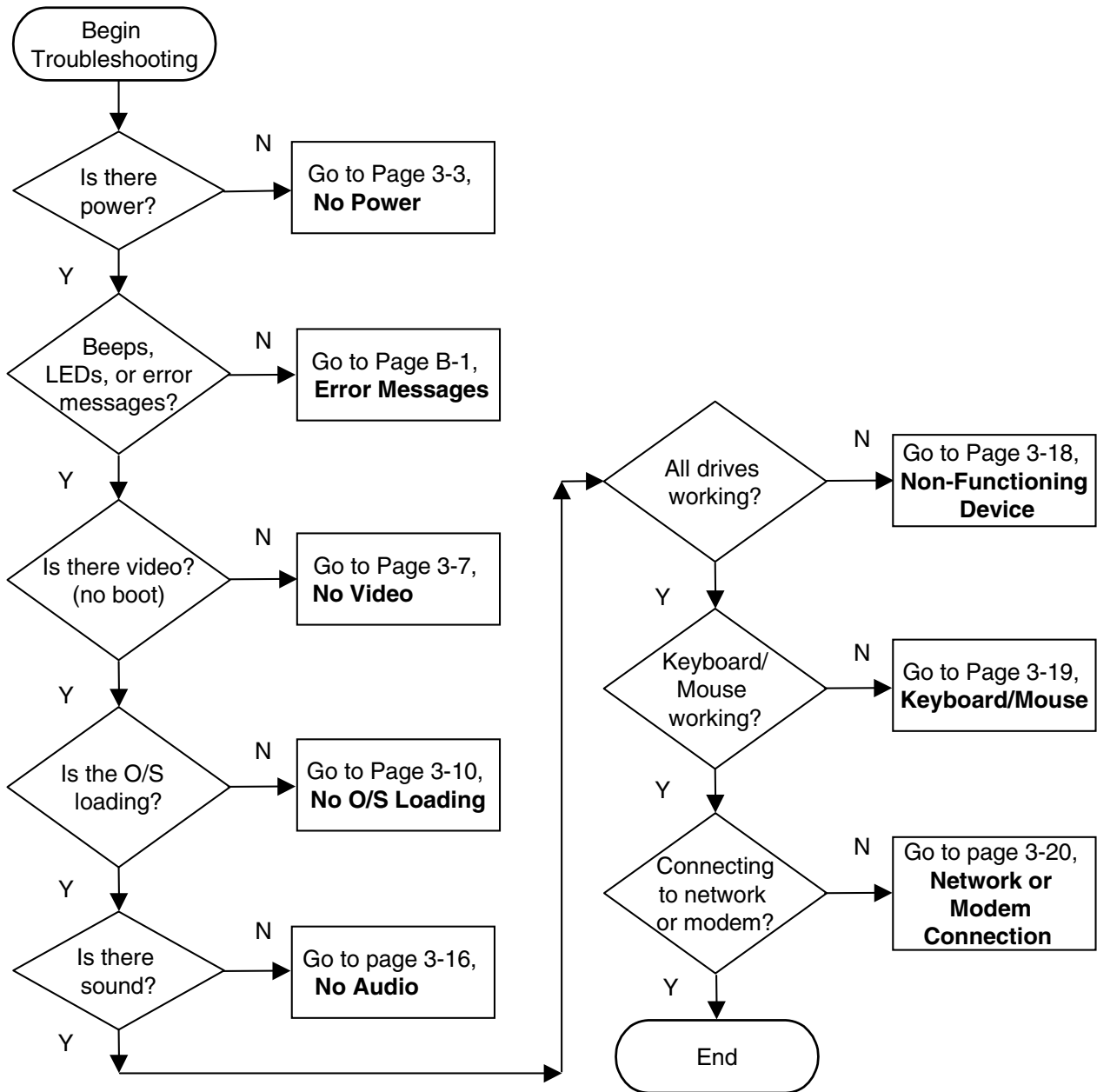

2. No Power, Part 1

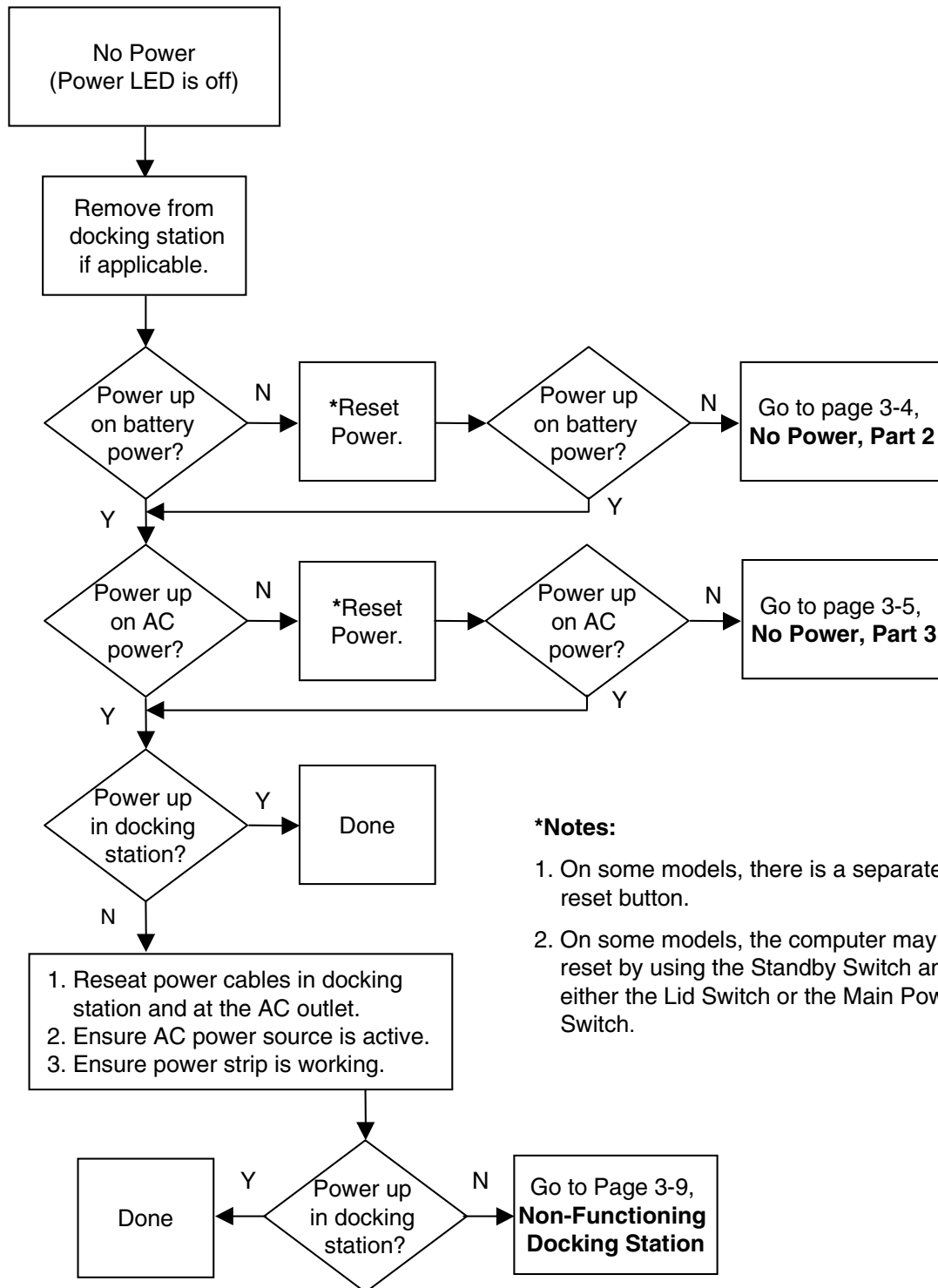

***Notes:**

1. On some models, there is a separate reset button.
2. On some models, the computer may be reset by using the Standby Switch and either the Lid Switch or the Main Power Switch.

3. No Power, Part 2

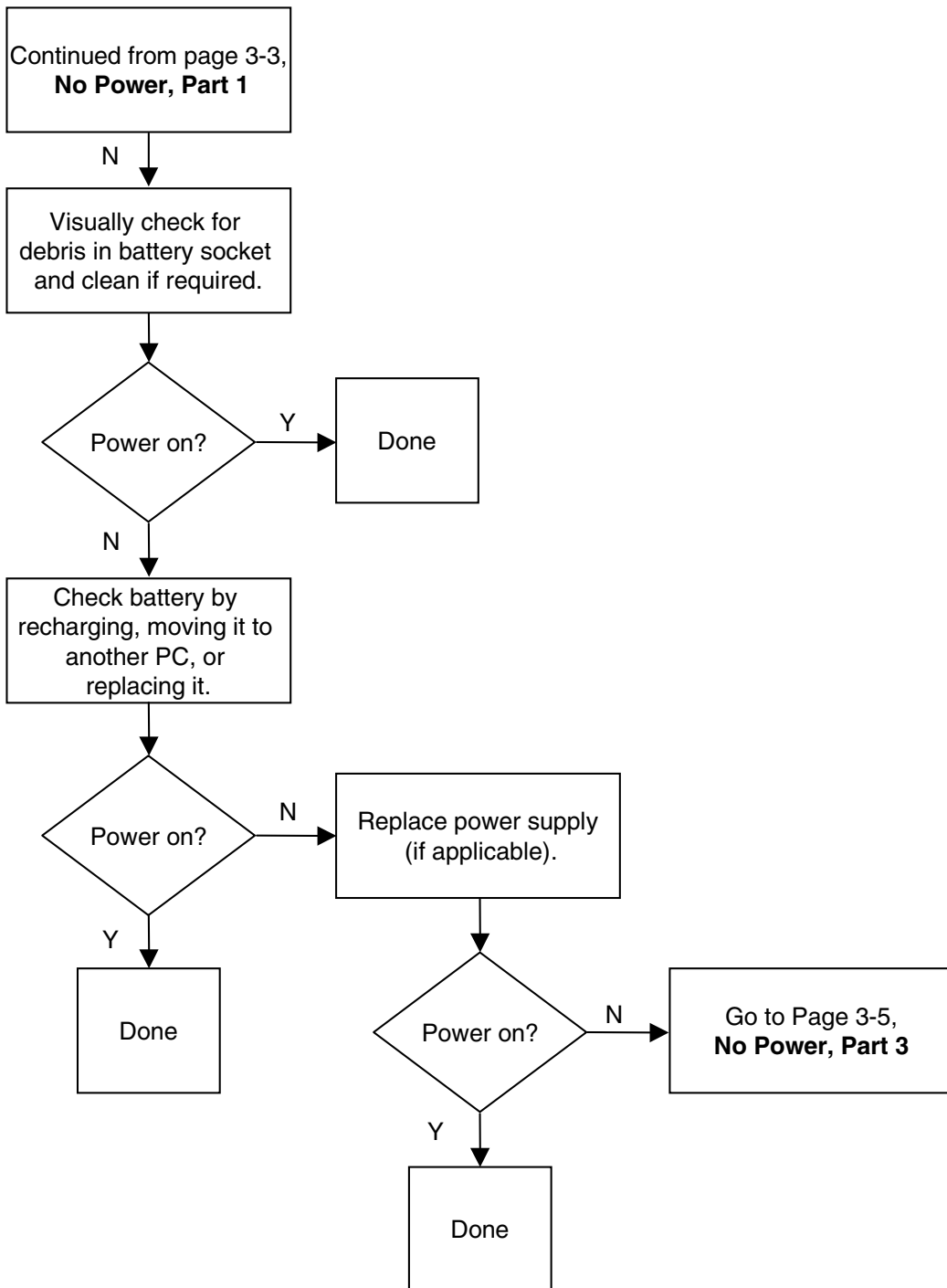

4. No Power, Part 3

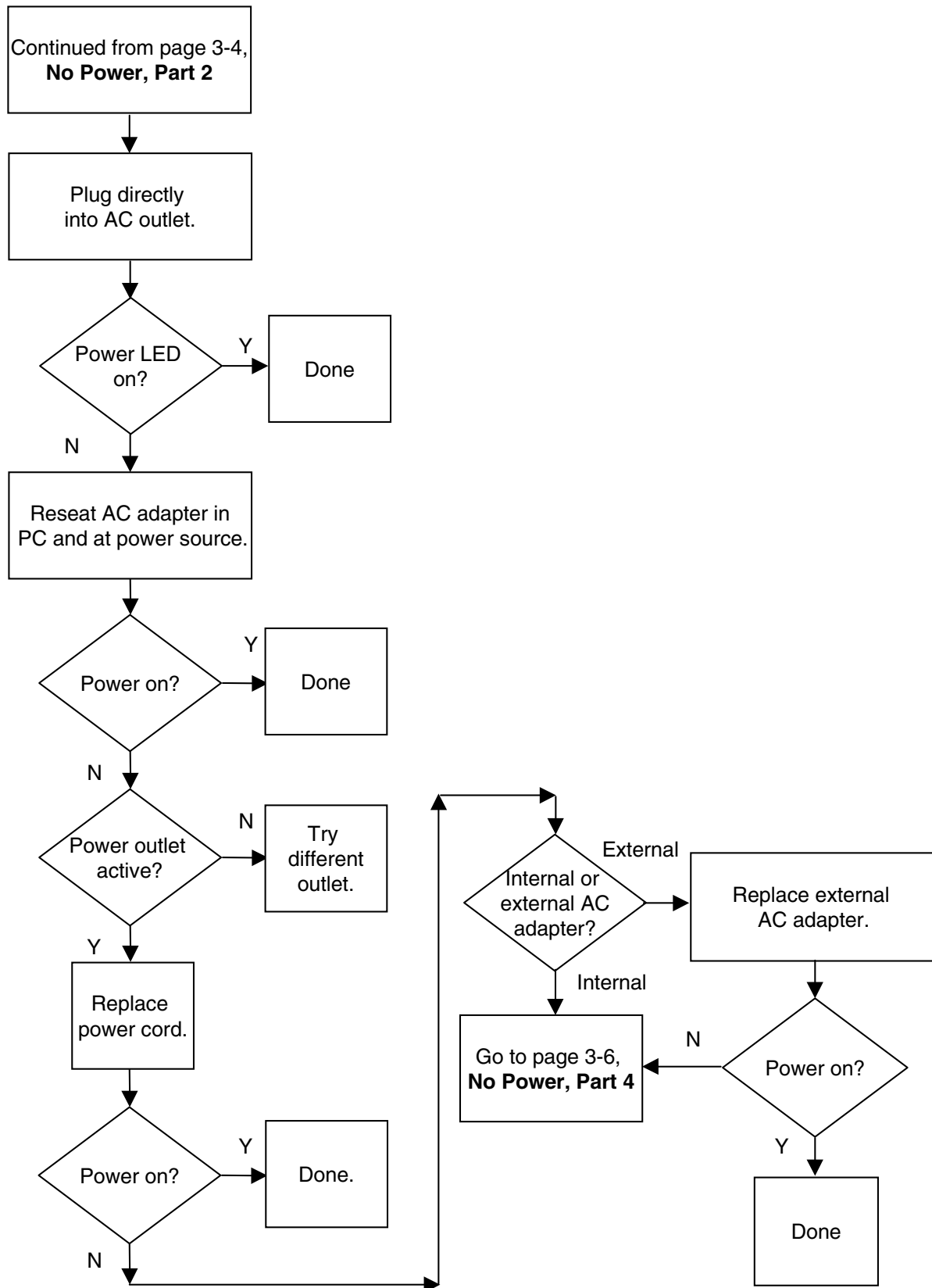

5. No Power, Part 4

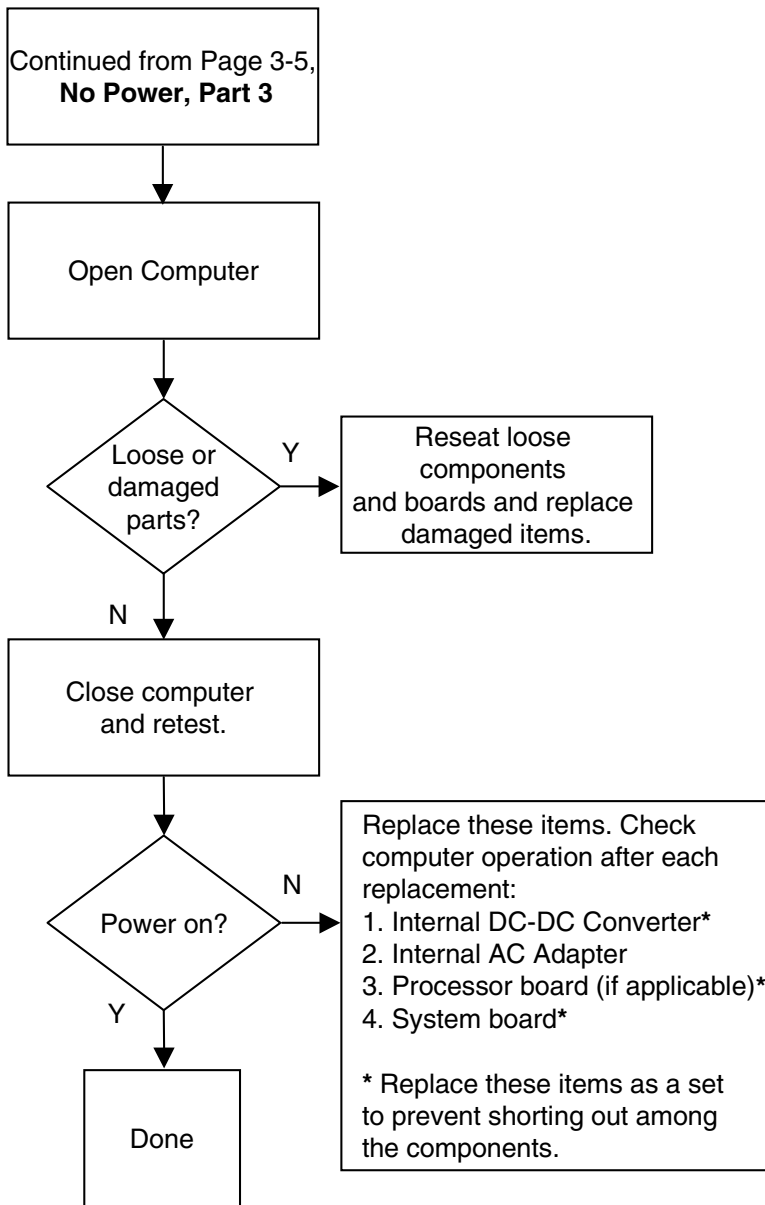

6. No Video, Part 1

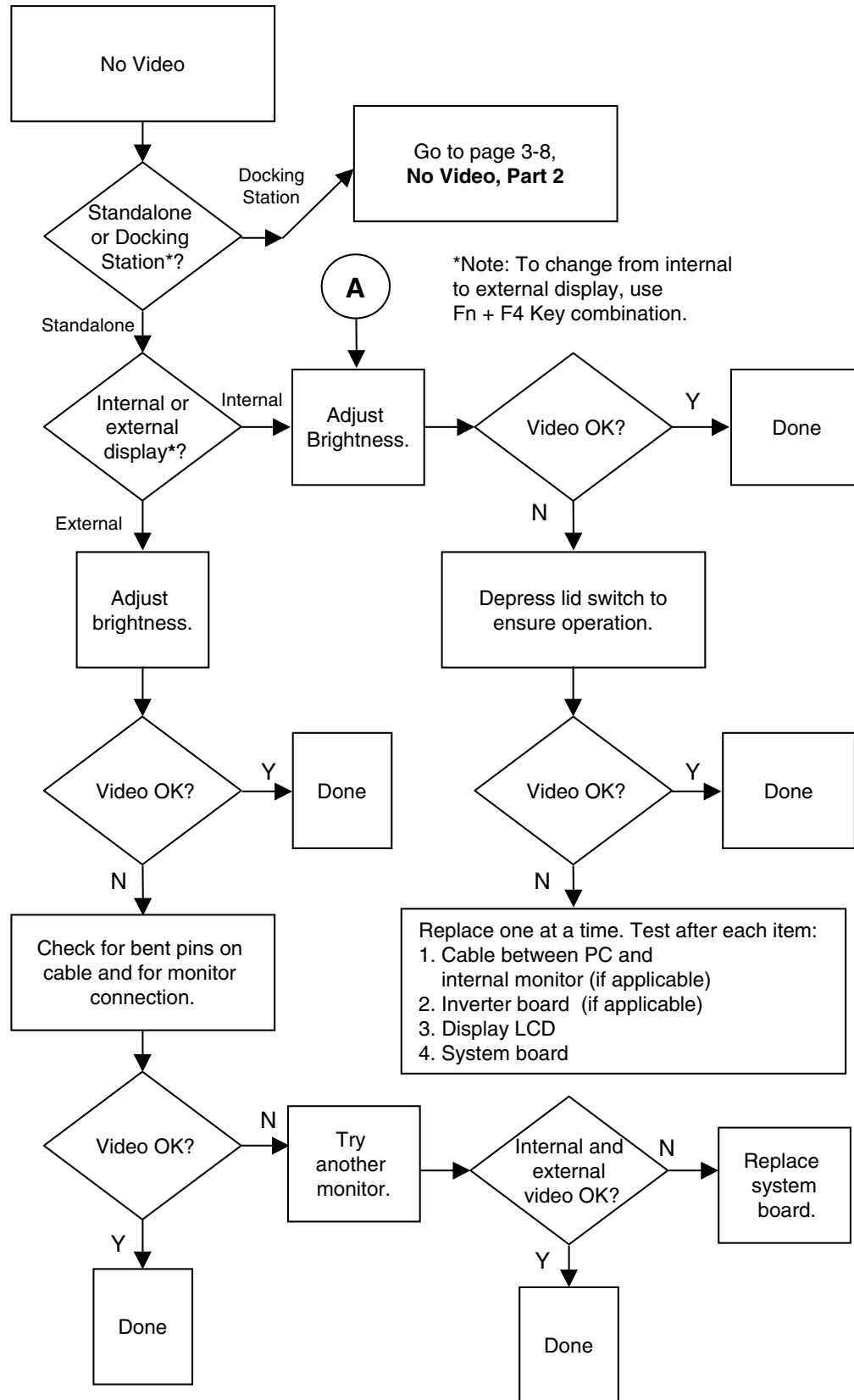

7. No Video, Part 2

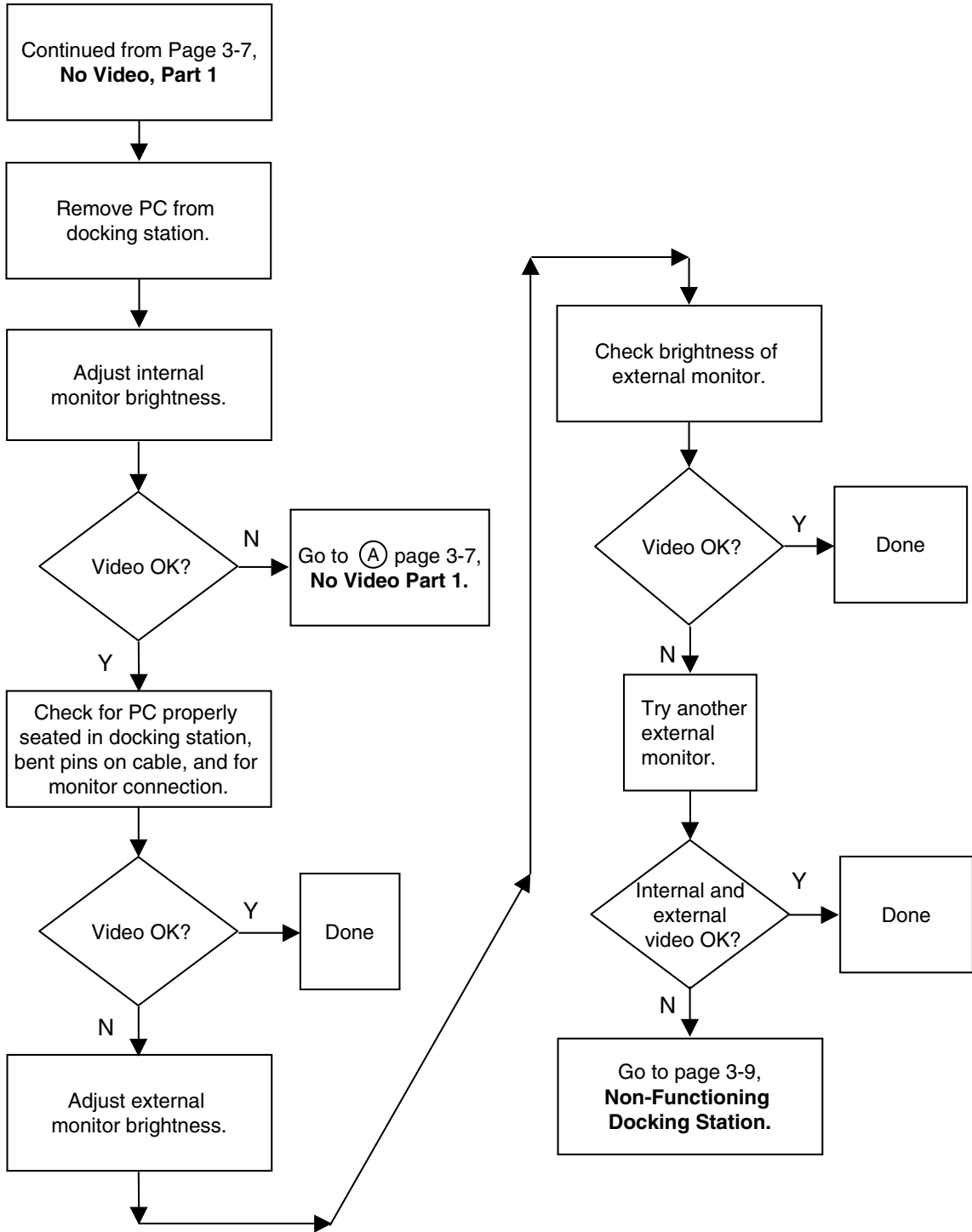

8. Non-Functioning Docking Station

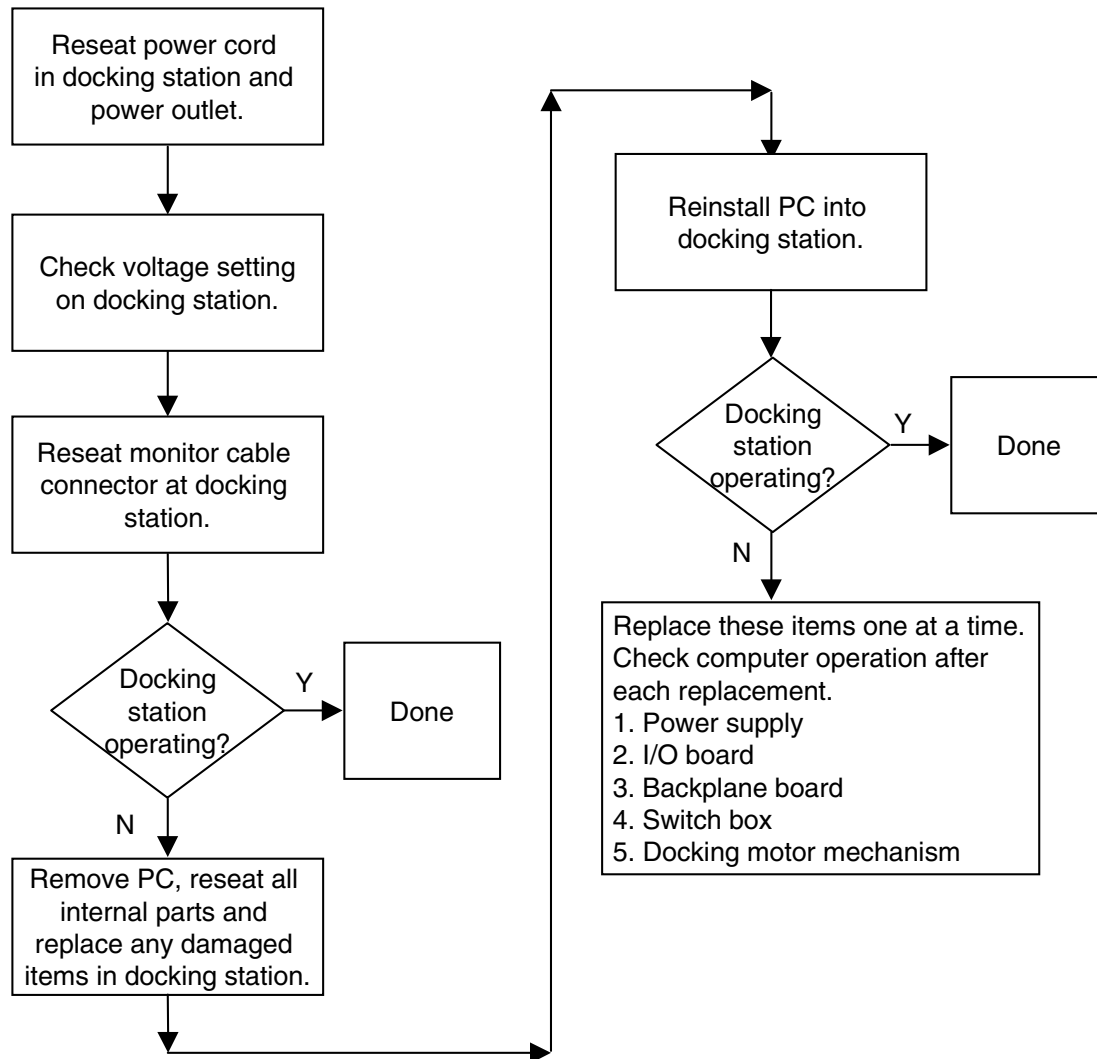

9. No O/S Loading

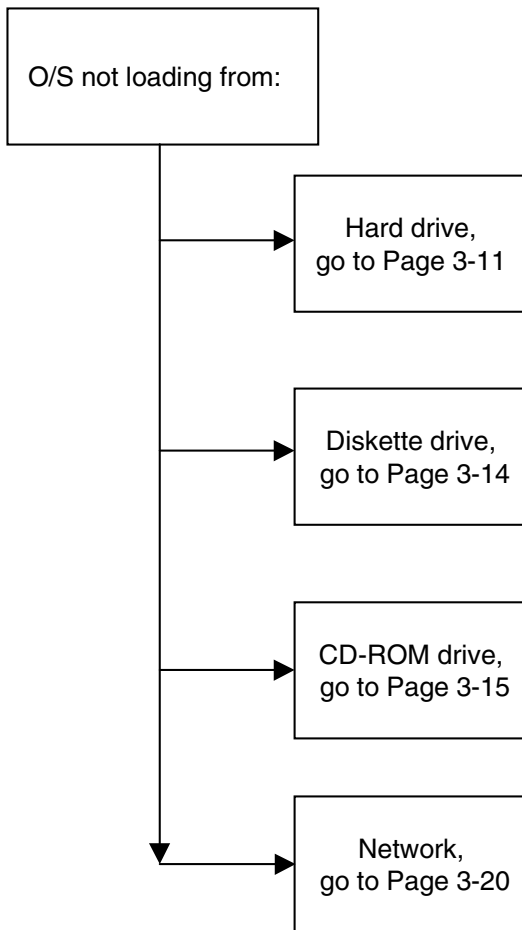

NOTE: Before beginning, always check drive jumpers, cable connections, cable ends, and drives for bent or damaged pins.

10. No O/S Loading from Hard Drive, Part 1

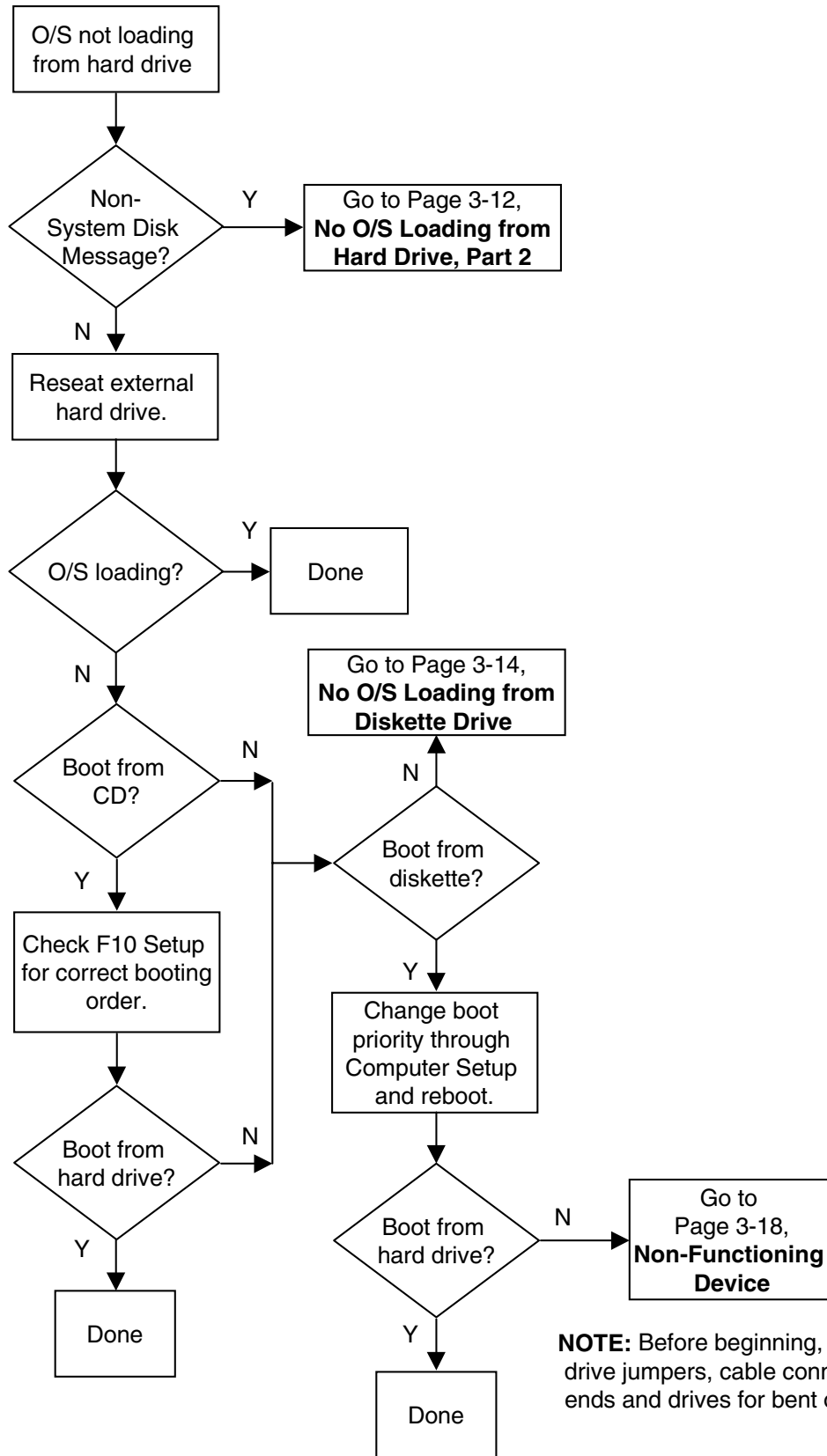

NOTE: Before beginning, always check drive jumpers, cable connections, cable ends and drives for bent or damaged pins.

11. No O/S Loading from Hard Drive, Part 2

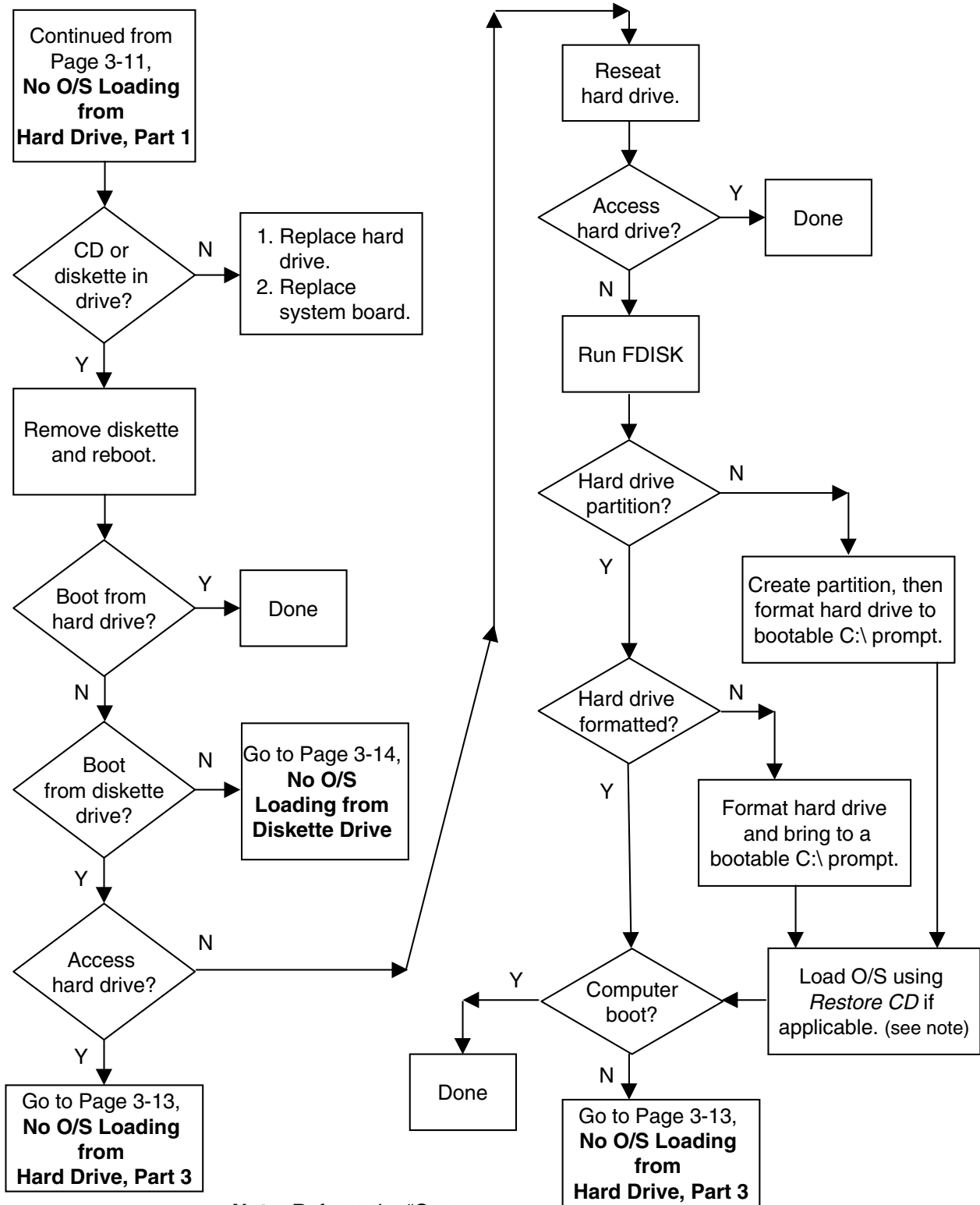

Note: Refer to the “Customer Responsibilities” section of this document and the customer service contract.

12. No O/S Loading from Hard Drive, Part 3

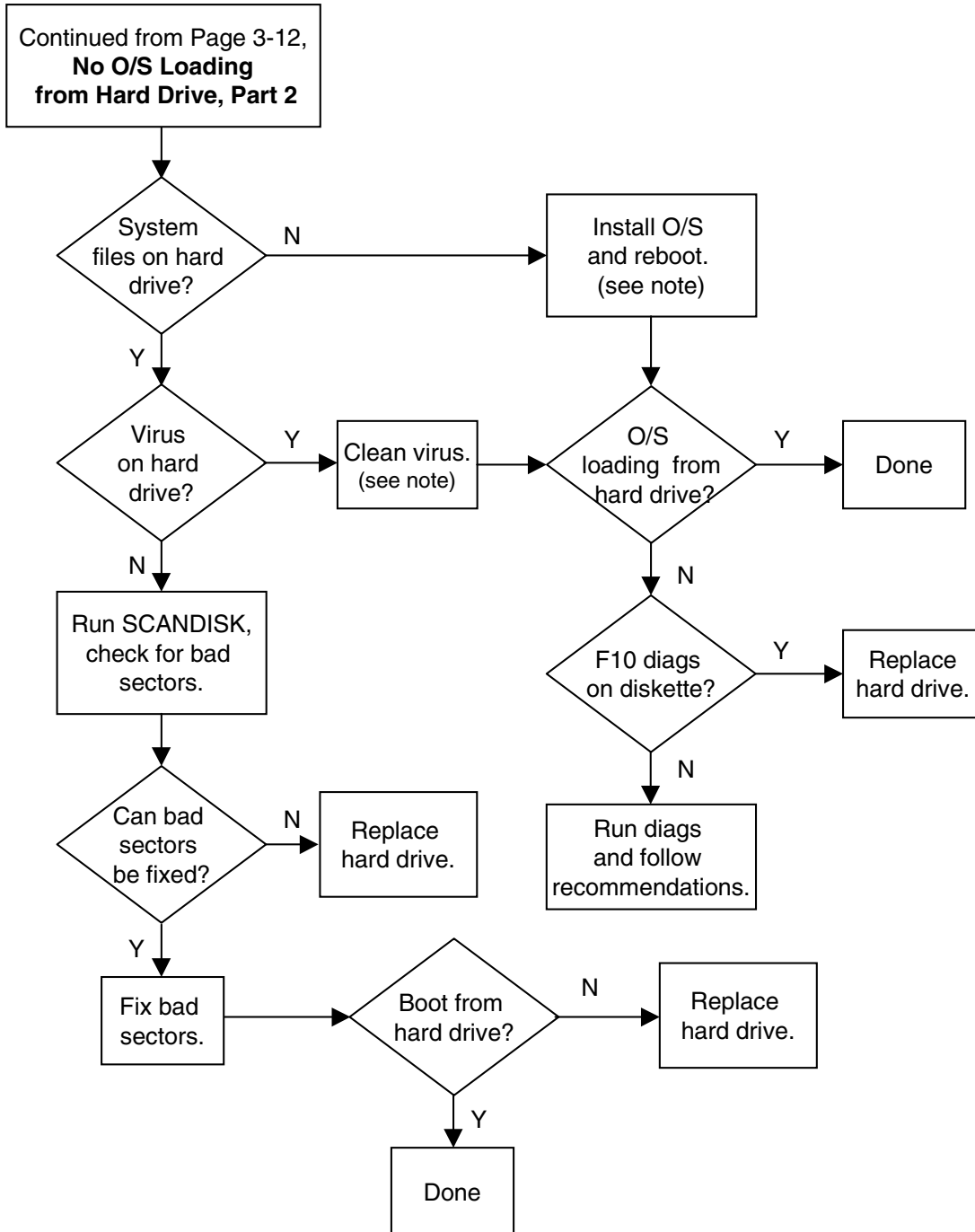

13. No O/S Loading from Diskette Drive

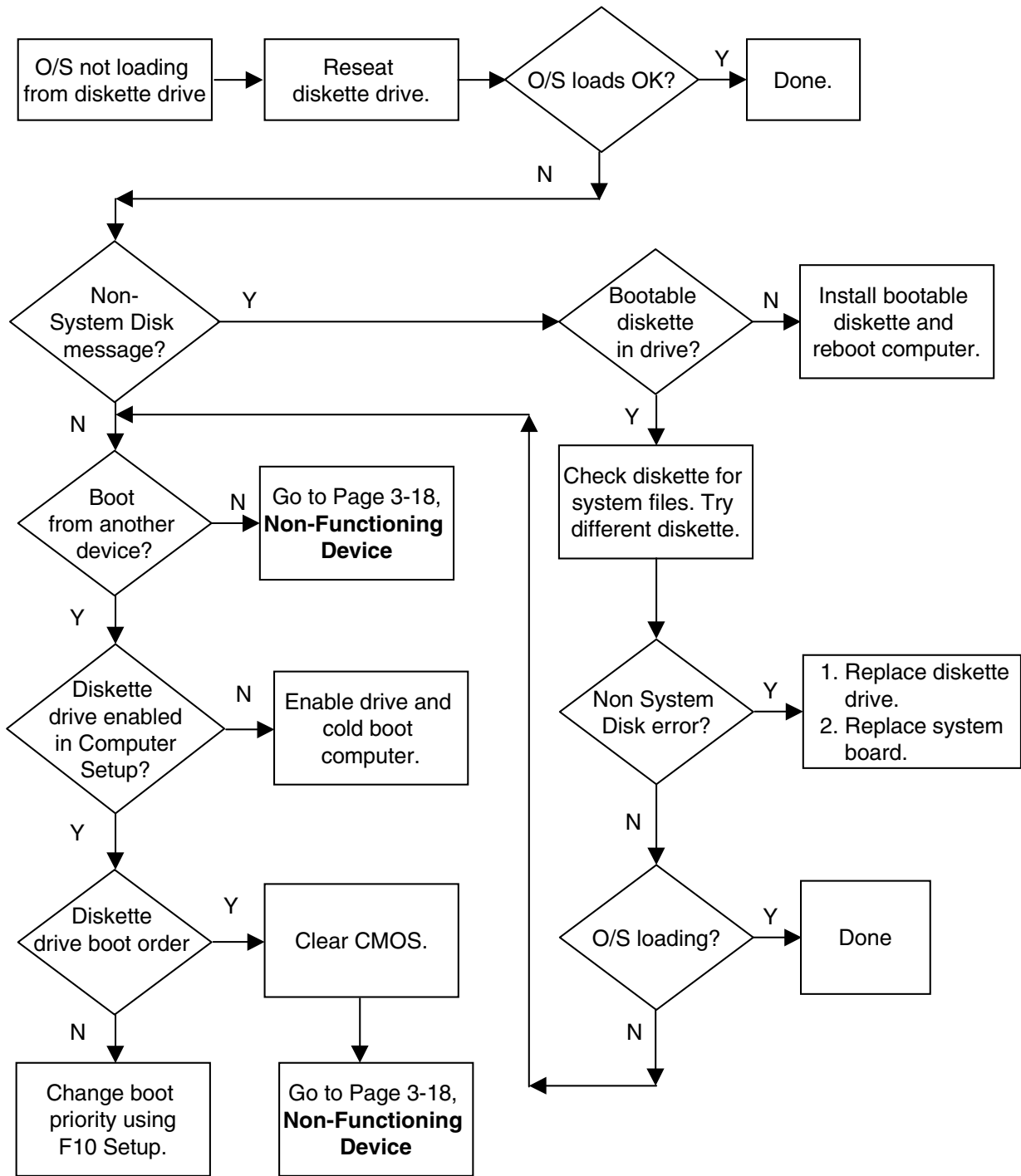

14. No O/S Loading from CD-ROM or DVD-ROM Drive

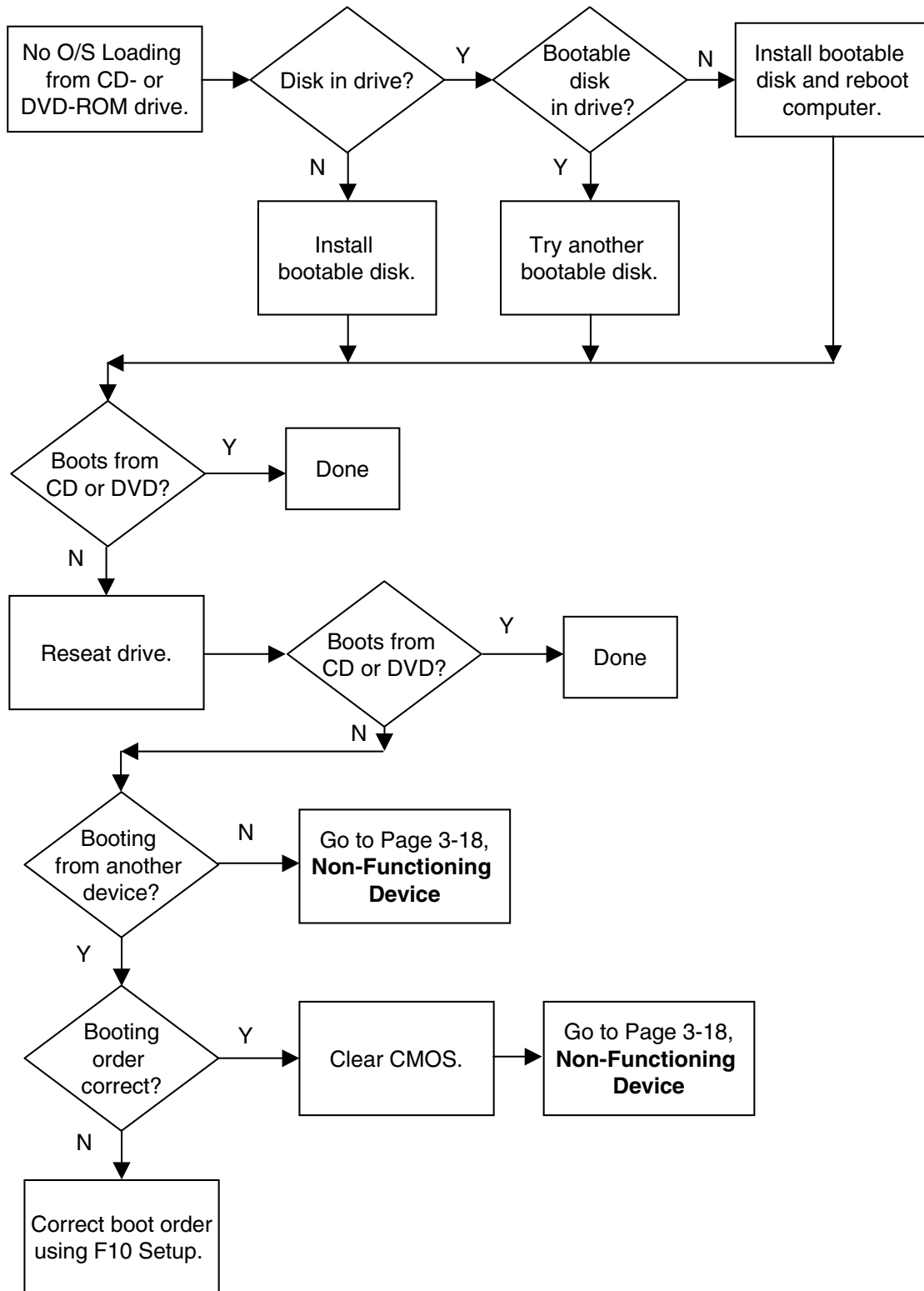

15. No Audio, Part 1

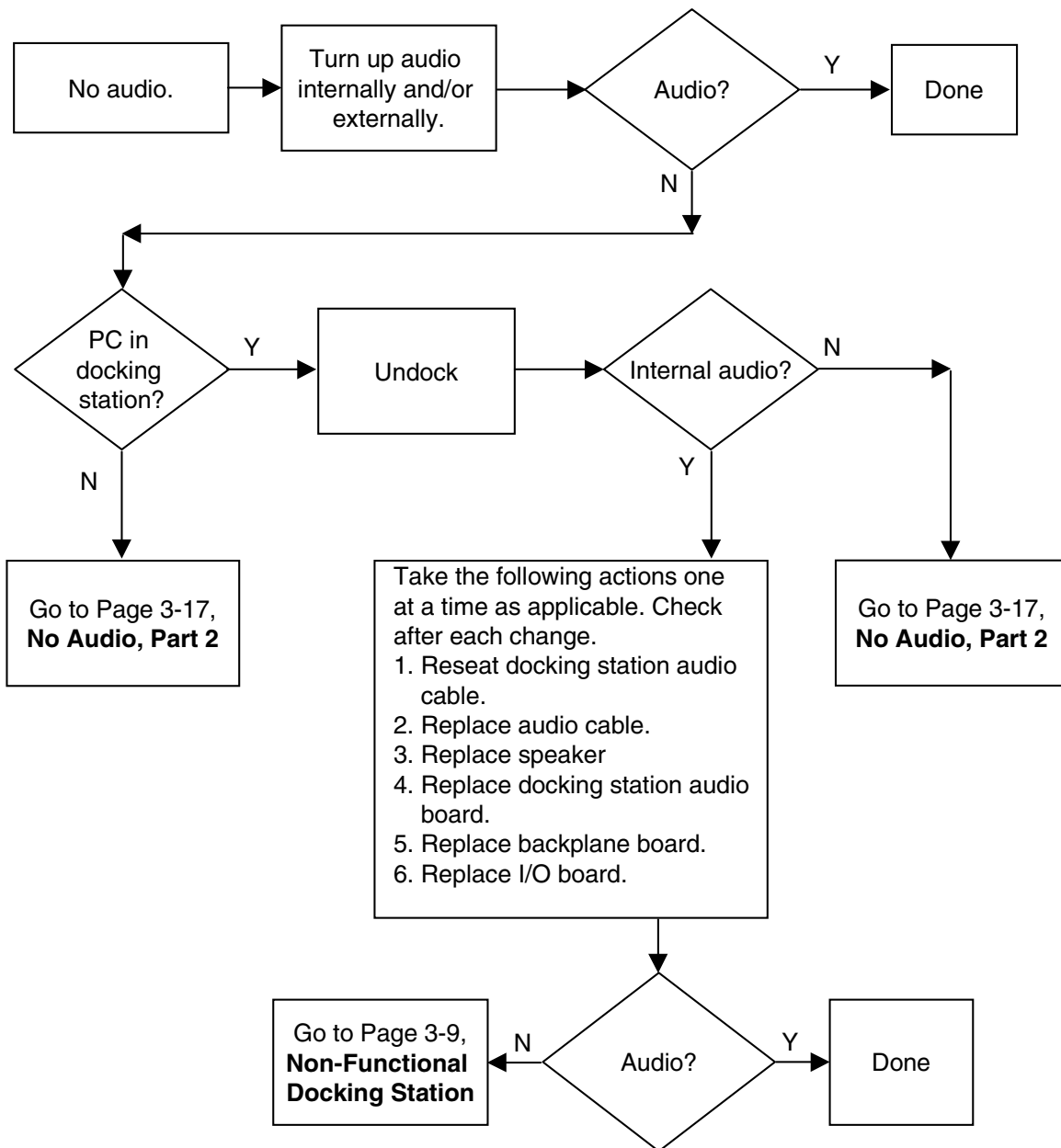

16. No Audio, Part 2

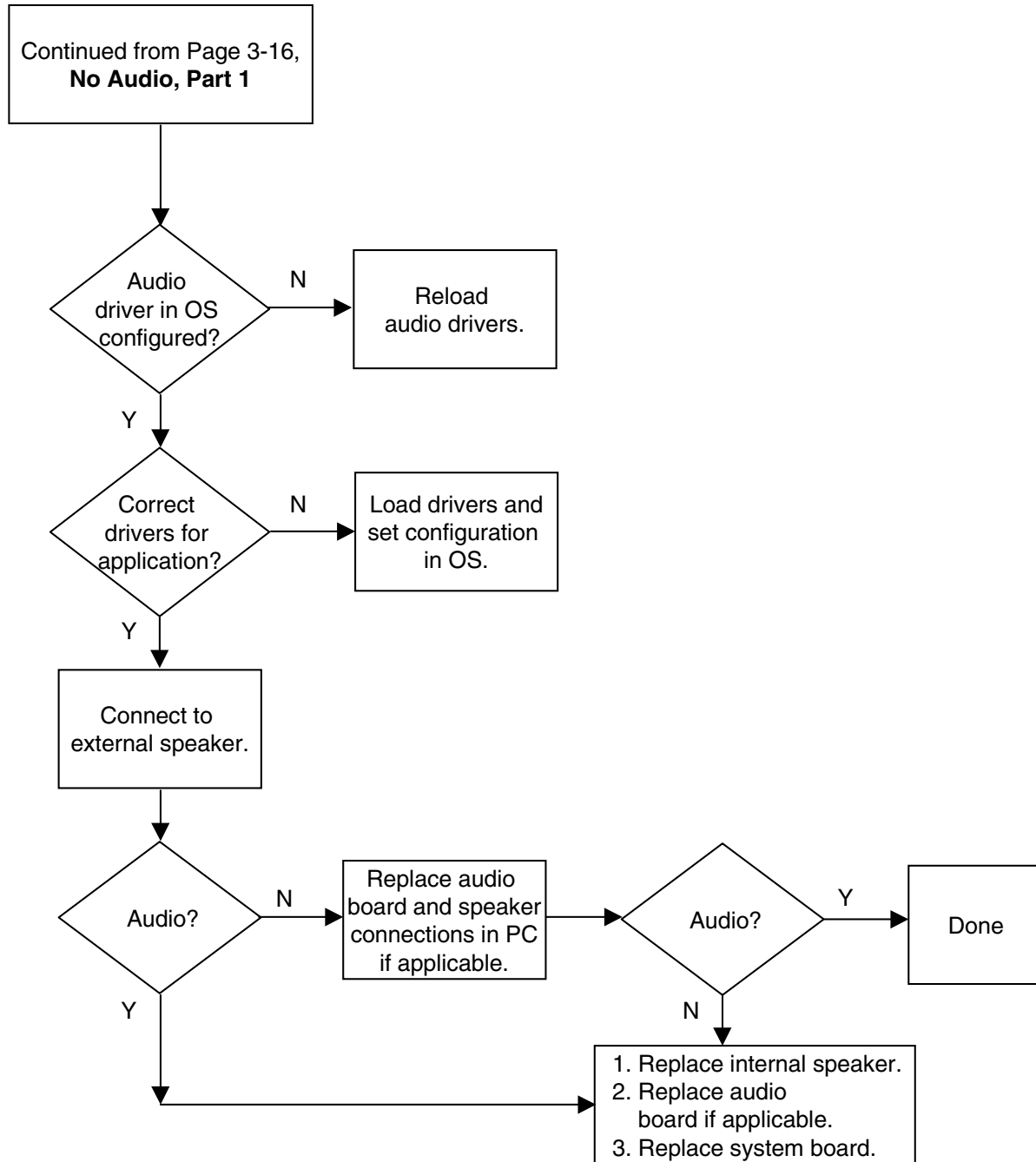

17. Non-Functioning Device

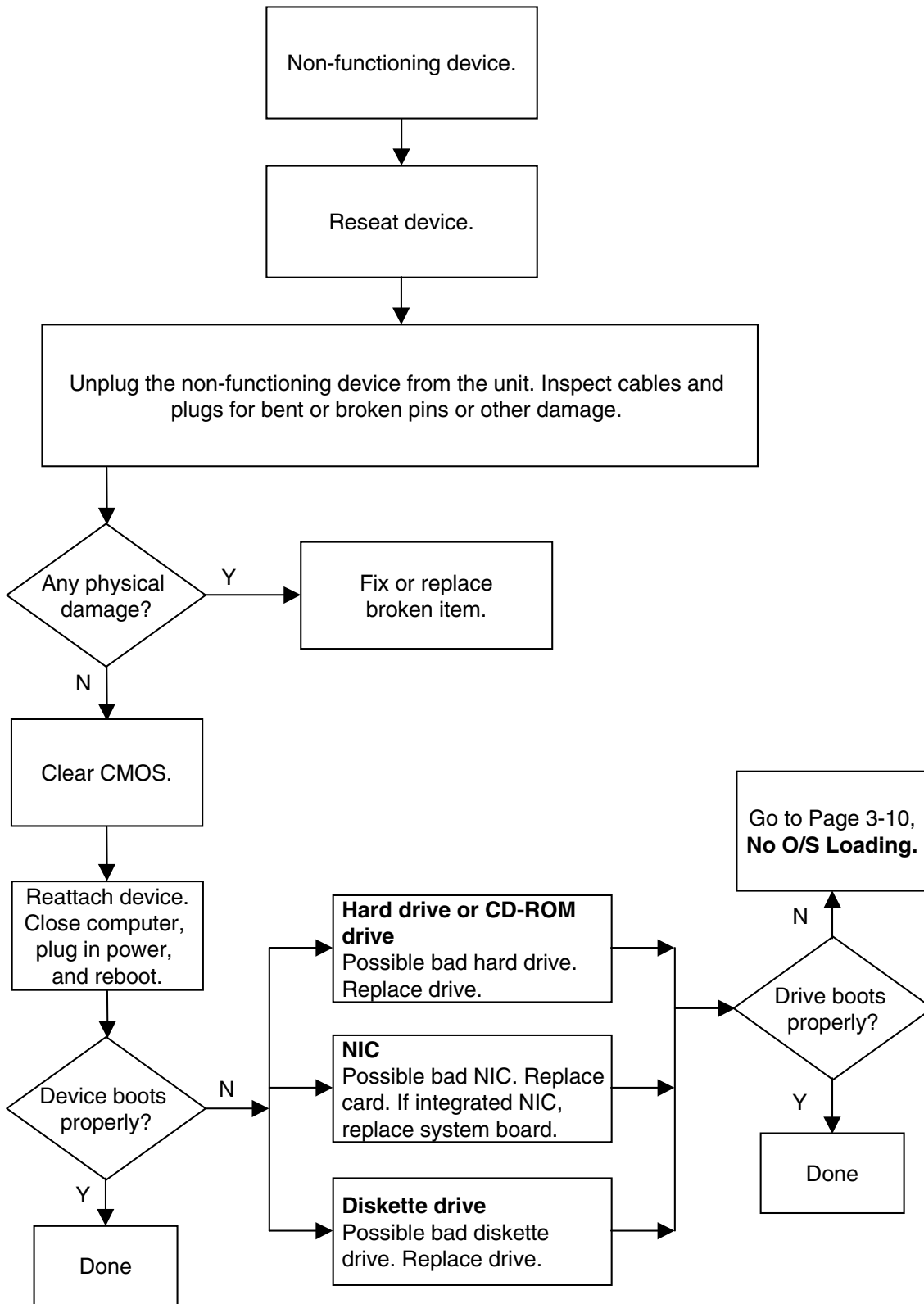

18. Non-Functioning Pointing Device or Keyboard

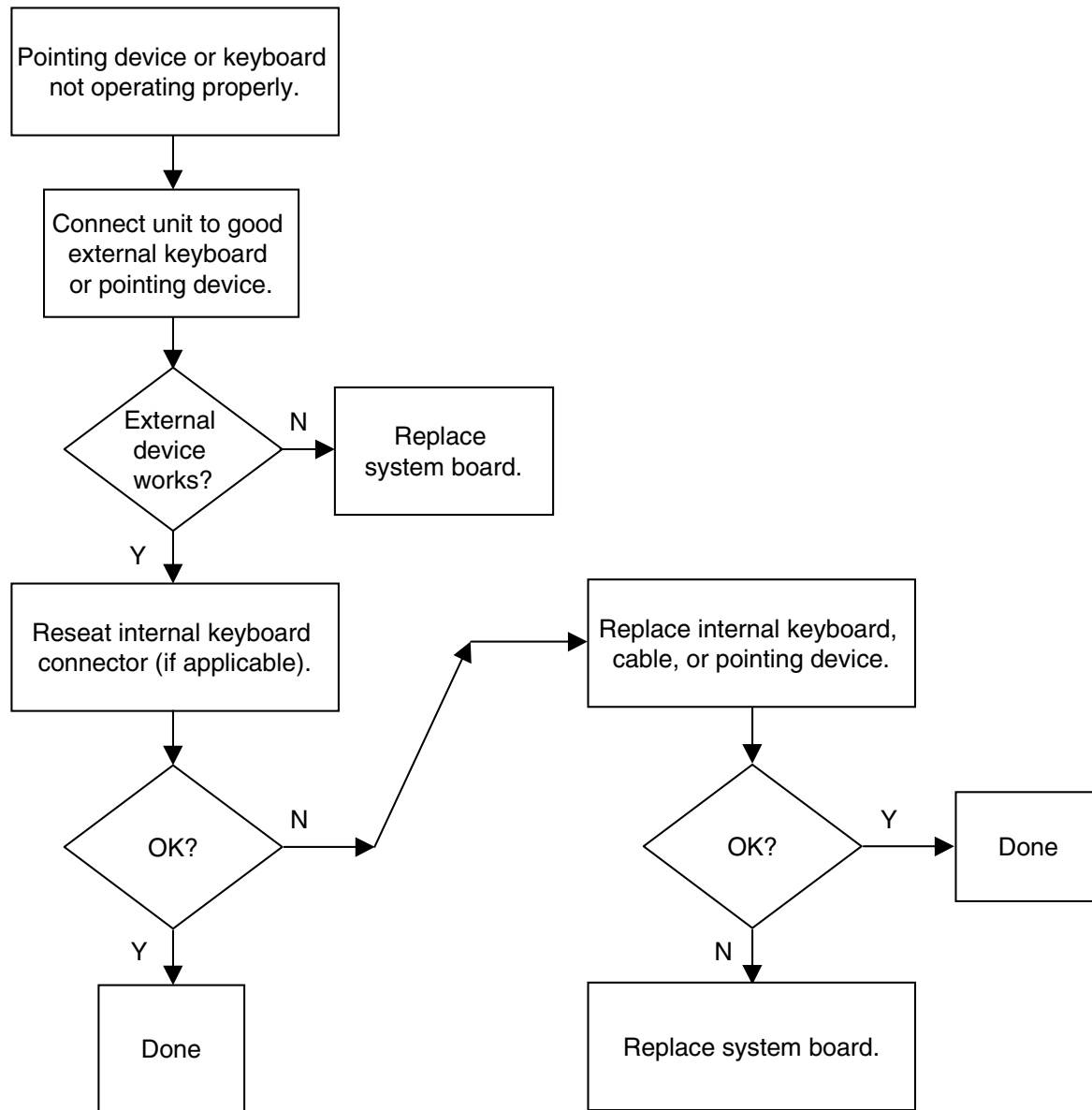

19. No Network or Modem Connection

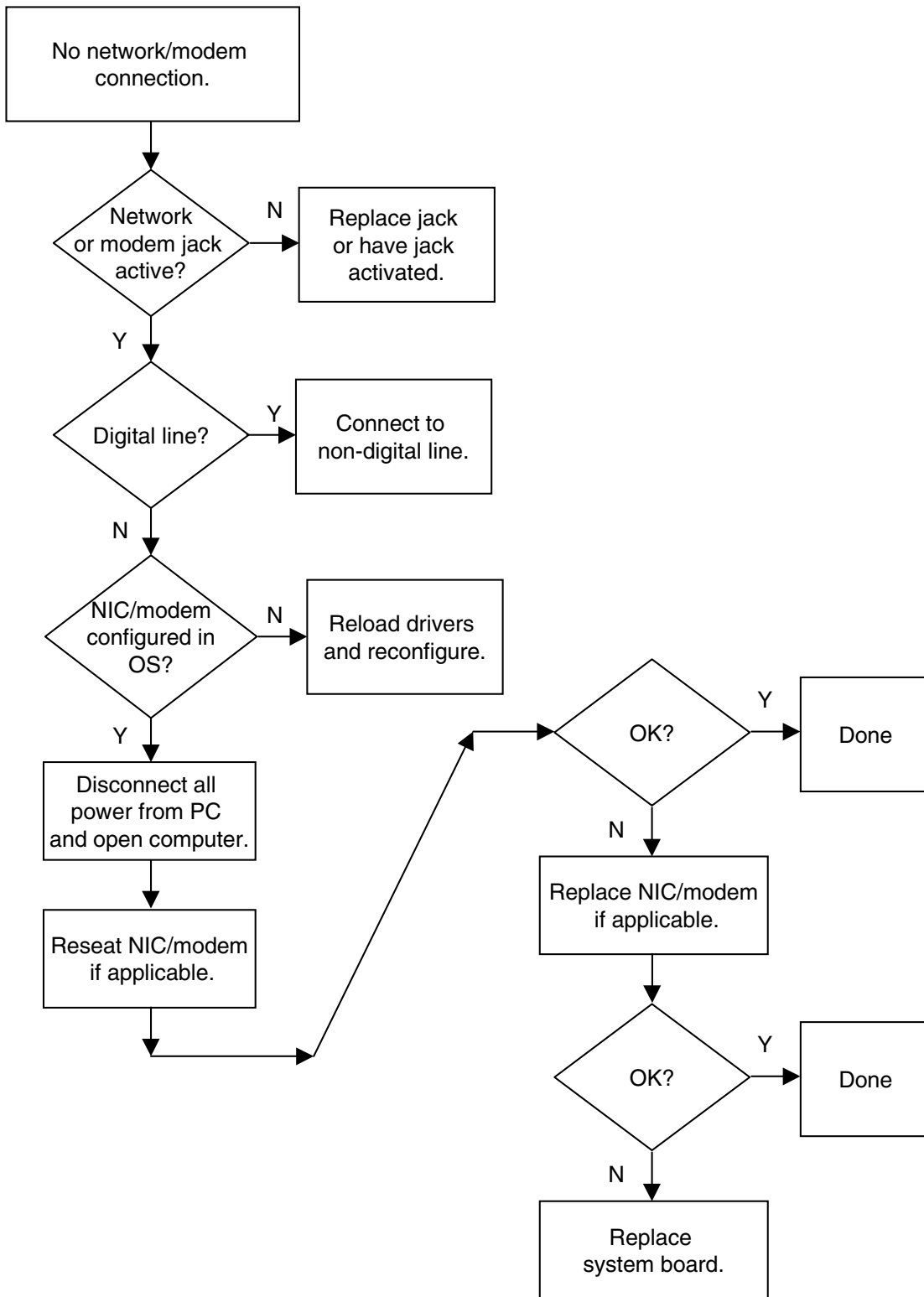

appendix **A**

FURTHER TROUBLESHOOTING

Preliminary Checklist

This section describes some simple, preliminary tests and guidelines for troubleshooting the computer without using the diagnostics.

If you encounter some minor problem with the computer or a software application, go through the following checklist for possible solutions before running any of the diagnostic utilities:

- Are the computer and monitor connected to a working electrical outlet?
- Is the computer turned on?
- Is the green power light illuminated?
- Is the monitor turned on?
- Is the green monitor light illuminated?
- Turn up the monitor brightness and contrast controls if the monitor is dim.
- Press and hold any key. If the system beeps, then the keyboard should be operating correctly.
- Check all cables for loose or incorrect connections.
- Reconfigure the computer after installing a non Plug and Play expansion board or other option, such as a diskette drive.
- Are all of the necessary device drivers installed?
- Have all printer drivers been installed for each application?
- Remove all diskettes from the diskette drives before you turn on the system.
- Are all switches set correctly?
- Is the NIC Remote Wakeup cable (featured on some models) connected between the NIC and the riser/system board?
- Are all memory sockets filled on computers using RIMMs?
- Ensure that memory module types are not mixed on the same system board. The system will not boot if RIMMs and DIMMs are mixed.

Solving General Problems

Problem

Computer will not turn on.

Possible Solution

1. Ensure computer is properly connected to an external power source.
2. A PCI or ISA card that has been installed is defective. Remove any adapter card that was just installed.
3. Ensure that drive power, data, and power supply cables are all properly seated.
4. See "Initial Troubleshooting" Flowchart.

Computer appears locked up and won't turn off when the power button is pressed.

Software control of the power button may not be functional. Press and hold the button for four seconds, then release. This invokes the hardware override for the power button.

Computer date and time display is incorrect.

Reset the date and time using Control Panel. If the problem persists, the real-time clock (RTC) battery may need to be replaced.

When booting from a network, the PC clock may be reset to that of the server. The PC clock may also change when using other services through the server.

Computer powered off unexpectedly.

1. The unit temperature was exceeded because the unit is in an exceedingly hot environment or the fan is blocked. Let the unit cool down.
2. The fan may not be functioning correctly or air vents may be blocked.
3. The unit temperature was exceeded because the computer was running with the cover or side panel removed. Replace cover or side panel, and let the computer cool down before turning power back on.

Insufficient power to the components.

Ensure that both power supply cables are connected to the system board (some workstations).

Computer appears to pause periodically.

Network driver is loaded and no network connection is established. Establish a network connection, or use Computer Setup or Windows Device Manager to disable the network controller.

Cannot remove computer cover or side panel.

1. Smart Lock, featured on some computers, is locked. Unlock using Computer Setup.
2. The Smart Cover FailSafe Key, a device for manually disabling the Smart Cover Lock, is available from Compaq. You'll need the FailSafe Key in cases of forgotten password, power loss, or computer malfunction.

Computer does not boot up and power and hard drive LEDs are blinking.

1. Ensure that the riser board is properly seated (if applicable).
2. See "Error Messages" Flowchart.

Solving General Problems Continued

Problem

Computer does not boot up and Num Lock LED is blinking; you may hear one short and two long beeps.

The Caps Lock LED is flashing; you may hear one long and two short beeps.

Computer does not boot up and the Scroll Lock LED is flashing; you may hear two long and one short beeps.



If the standard keyboard has been replaced with a Universal Serial Bus (USB) keyboard, you will hear the beep sequences mentioned above but will not see the flashing lights.

Possible Solution

1. System memory may be improperly installed or may be bad.
2. See “Error Messages” Flowchart.

1. The video controller is not present or is incorrectly initialized.
2. Clear CMOS.
3. If a video board has been added, remove and reseal it.
4. See “No Video” Flowchart.

1. System board hardware failure (prior to video). Replace system board.
2. See “Initial Troubleshooting” Flowchart.

Power Supply

Problem

Computer will not turn on.

Power LED blinks red once every 2 seconds.

Power supply shuts down intermittently.

Possible Solution

1. Computer not connected to active external power source. Connect power cable to active wall plug or power strip.
2. Power switch not connected to system board. Plug the power switch cable into the system board.
3. Power line selector switch on rear of computer set to wrong voltage. Select the proper AC voltage (115V or 230V).

1. Power supply overloaded or short detected. Unplug computer from AC power source. Unplug internal power cables from all devices and unplug PCI cards. Reconnect devices one at a time to identify the cause.
2. Diskette drive power cable not properly connected. Ensure that all 4 pins on the drive are connected to the power cable connector.
3. Power supply shuts down after system warms up. Thermal overload caused by bad fan. Replace power supply.
4. Power supply will not turn on because of internal power supply fault. Replace power supply.

1. Power line selector switch on rear of computer set to wrong voltage. Select the proper AC voltage (115V or 230V).
2. Power supply will not turn on because of internal power supply fault. Replace power supply.

Diskette Drive

Problem

Diskette drive light stays on.

Possible Solution

1. Diskette is damaged. In Windows 95, 98, or 2000, run ScanDisk. In Windows NT, run Error-checking.
2. Diskette is incorrectly inserted. Remove the diskette and reinsert.
3. Software program may be damaged. Check the program diskettes.
4. Drive button is not pushed in. Push in drive button.
5. Drive cable is not properly connected. Reconnect drive cable.

Diskette drive cannot write to a diskette.

1. Diskette is not formatted. Format the diskette.
2. Diskette is write-protected. Either use another diskette that is not write-protected or disable the write protection on the diskette.
3. Writing to the wrong drive. Check the drive letter in the path statement.
4. Not enough space is left on the diskette. Use another diskette.
5. Diskette write control is enabled. Check the Removable Media write settings in Computer Setup.

Cannot format diskette.

Invalid media reported. When formatting a diskette in DOS, you may need to specify diskette capacity. For example, to format a 1.44-MB diskette, type the following command at the DOS prompt:

```
FORMAT A:/F:1440
```

Diskette drive cannot read a diskette.

1. Diskette is not formatted. Format the diskette.
2. Using the wrong diskette type for the drive type. Check the drive type and use a compatible diskette.
3. Reading the wrong drive. Check the drive letter in the path statement.
4. Diskette drive has been disabled by Computer Setup, Windows NT, Windows 95, 98, or 2000 utilities. Run Computer Setup and enable the diskette drive.

Non-system disk message.

1. The system is trying to start from a nonsystem diskette. Remove the diskette from the drive.
2. Diskette MBR validation enabled. Disable the MBR validation option.

Drive not found.

1. Check the cables for loose connections.
2. If a second diskette drive has been installed, follow the computer reconfiguration directions in the "Hardware Installation Problems" section.
3. See "Non-Functioning Device" Flowchart.

Diskette Drive Continued

Problem

A problem has occurred with a disk transaction.

System has misidentified the diskette drive type.

Possible Solution

The directory structure is bad, or there is a problem with a file. Run ScanDisk.

If a diskette drive other than a 3.5-inch, 1.44-MB drive has been installed, ensure that the drive type is identified correctly under Computer Setup.

Hard Drive

The information provided by the diagnostics tests includes: error code, system serial number, drive serial number, drive model, and drive firmware revision. Specific details of the drive failure are not included.

When you run the diagnostics, the test results are stored in a log. After completing the test, you can print this log to a local printer or save it to a file. Alternatively, before running the test, you can configure the test options to send the results to a local printer or file.

Problem

Hard drive error occurs.

Disk transaction problem.

Drive not found.

Second Ultra ATA hard drive does not perform optimally.

Possible Solution

1. Hard disk has bad sectors or has failed. Use a utility to locate and block usage of bad sectors. If necessary, reformat the hard disk.
2. See "Non-Functioning Device" Flowchart.

1. Either the directory structure is bad or there is a problem with a file.

In Windows 95, 98, or 2000, run ScanDisk.

In Windows NT, right-click Start, click Explore, and select a drive. Select File→Properties→Tools. Under Error-checking, click Check Now.

2. See "Non-Functioning Device" Flowchart.

1. Cable could be loose. Check cable connections.
2. The system may not have automatically recognized a newly installed device. See reconfiguration directions in the "Hardware Installation Problems" section. If system still does not recognize the new device, check to see if the device is listed within Computer Setup. If it is listed, the probable cause is a driver problem. If it is not listed, the probable cause is a hardware problem.
3. Check drive jumper settings. If the drive is a secondary drive that has just been installed on the same controller as the primary drive, verify that the jumpers for both drives are set correctly.
4. Check SCSI IDs to ensure none are duplicated.
5. See "Non-Functioning Device" Flowchart.

The cable is not compatible with the drive type. Reinstall the second Ultra ATA hard drive using an 80-conductor cable.

Display

Problem

Screen is blank.

Possible Solution

1. Monitor is not turned on and the monitor light is not on. Turn on the monitor and check that the monitor light is on.
2. Screen save has been initiated. Press any key or move the mouse to light the screen.
3. The cable connections are not correct. Check the cable connection from the monitor to the computer and check the electrical outlet.
4. The brightness need adjusting. Adjust the brightness control.
5. The QuickBlank feature has been enabled through Computer Setup. Run Computer Setup to disable it.
6. The energy saver feature has been enabled. Press any key or click the mouse button and, if one has been set, type the password.
7. The RGB (Red, Green, Blue) input switch on the back of the monitor is incorrectly set. Set the monitor's input switch to 75 ohms and set sync switch to External (if applicable).
8. System ROM is bad and system is running in FailSafe Boot Block mode (indicated by one long beep and three short beeps). Reflash the ROM using a ROMPaq diskette.
9. If a fixed-sync monitor is used, be sure that the monitor can accept the same sweep rate as the resolution chosen.
10. See "No Video" Flowchart.

Video colors are wrong.

1. Either the cabling or the monitor impedance is incorrect.
2. Ensure that the Red, Green, and Blue BNC cables are connected to the corresponding monitor connectors.
3. Be sure the monitor's RGB inputs are set to 75 ohms.

Characters are dim.

1. Adjust the monitor's brightness and contrast controls.
2. Check that the video cable is securely connected to the video card and monitor.
3. Set the RGB switch (and sync options, if available) to 75 ohms, with the sync set to External. Refer to the documentation included with the monitor.

Monitor does not function properly when used with the energy saver features.

Monitor without the energy saver feature is being used with energy saver features enabled. Disable the monitor energy saver features.

Screen goes blank.

A screen blanking utility may be installed or energy saver features may be enabled. Press any key or type password.

Blurry display or requested resolution cannot be set.

If the video controller was upgraded, the correct display drivers may not be loaded. Install the correct display drivers on the diskette included in the upgrade kit.

continued

Display Continued

Problem

The picture is broken up; it rolls, jitters, or blinks.

Possible Solution

1. Ensure the monitor cable is securely connected to the computer.
2. In a two-monitor system or if another monitor is in close proximity, move the monitors apart to be sure they are not interfering with one other's magnetic field.
3. Fluorescent lights or fans may be too close to the monitor.

Monitor overheats.

There is not enough ventilation space for proper airflow. Leave at least 3 inches (7.6 cm) of ventilation space. Be sure there is nothing on top of the monitor obstructing the air flow.

Cursor will not move using arrow keys on the numeric keypad.

The Num Lock key is on. Press the key to turn it off. The Num Lock light should not be on when you want to use the arrow keys.

Printer

Problem

Printer will not print.

Possible Solution

1. Printer is not turned on and online. Turn the printer on and make sure it is online.
2. Try printing using the DOS command DIR C:\ > [printer port]. If printer works, reload printer driver.
3. If the computer is on a network, you may not have made the connection to the printer. Make the proper network connections to the printer.

Printer will not turn on.

Reconnect all cables and check the power cord and electrical outlet.

Prints garbled information.

1. The correct printer drivers for the application are not installed. Install the correct printer driver for the application.
2. The cables may not be connected properly. Reconnect all cables.

Printer is off line.

The printer may be out of paper. Check the paper tray and refill it if it is empty. Select online.

SCSI

Problem

System with IDE and SCSI drives will not boot from SCSI hard drive.

Possible Solution

The IDE drive needs to be disabled. Under the Computer Setup Advanced menu, disable the primary IDE controller.

System will not boot from a SCSI drive.

1. The SCSI drive is not configured correctly.
2. Ensure that drive cabling and jumpers are set correctly. To boot a SCSI drive, the drive ID number must be set to 0.
3. See "No O/S Loading from Hard Drive" Flowchart.

Hardware Installation

You may need to reconfigure the computer when you add or remove hardware, such as an additional diskette drive. If you install a Plug and Play device, Windows 95 and 98 automatically recognizes the device and configures the computer. If you install a non-Plug and Play device, you must reconfigure the computer after completing installation of the new hardware. In Windows 95 and 98, select the Add New Hardware icon in the Control Panel and follow the instructions that appear on the screen. To reconfigure the computer in Windows NT Workstation 4.0 after installing new hardware, use the utility provided with the hardware.

Problem

A new device is not automatically recognized as part of the computer system.

Possible Solution

1. The computer needs to be reconfigured to recognize the new device. Follow the reconfiguration instructions above. If system still does not recognize the new device, but the device is listed within Computer Setup, use Computer Setup to address any resource conflicts.
2. When the system advised you of changes to the configuration, you did not accept them. Reboot the computer and follow the instructions for accepting the changes.
3. A Plug and Play board may not automatically configure when added if the default configuration conflicts with other devices. Use Windows 95, 98, or 2000 Device Manager to deselect the automatic settings for the board and choose a basic configuration that doesn't cause a resource conflict. You can also use Computer Setup to reconfigure or disable devices to resolve the resource conflict.
4. The cables for the new external device are loose or the power cables are unplugged. Check all cables, and check that pins in the cable or connector are not bent down.
5. The power switch for the new external device is not turned on. Turn off the computer, turn on the external device, and then turn the computer on to integrate the new device with the computer.
6. If the drive is a secondary drive that has just been installed on the same controller as the primary drive, verify that the jumpers for both drives are set correctly.

Insufficient power to the components.

Ensure both power supply cables are connected to the system board (some workstations).

Installed third-party SCSI hard drive adapter not participating in the hard drive ordering sequence provided in F10 Setup and/or is always coming up as the boot device regardless of the predetermined sequence.

The third-part adapter is either not supporting BIOS Boot Specification or the Boot Vector option. A solution is not available.

CD-ROM and DVD-ROM

Problem	Possible Solution
Cannot read compact disc.	<ol style="list-style-type: none">1. CD is not properly seated in the drive. Eject the CD, correctly seat it in the drive, then reload.2. CD is loaded upside down. Eject CD, turn it over, then reload.3. See "Non-Functioning Drive" Flowchart.
System will not boot from CD-ROM or DVD drive.	<ol style="list-style-type: none">1. The CD-ROM boot is not enabled through the Computer Setup utility. Run the Computer Setup utility and set the drive priorities.2. Ensure that drive cabling and jumpers are set correctly. To boot a SCSI drive, the drive ID number must be set to 0.3. See "No O/S Loading from CD-ROM Drive" Flowchart.
Cannot eject compact disc (tray-load unit).	CD is not properly seated in the drive. Turn off the computer and insert a thin metal rod into the emergency eject hole and push firmly (a straightened paper clip can be used). Slowly pull the tray out from the drive until the tray is fully extended, then remove the CD.
Cannot eject compact disc (slot-load unit).	<ol style="list-style-type: none">1. Remove the drive from the chassis.2. Remove the front bezel from the drive.3. Remove the top and bottom drive covers.4. Release the clamping mechanism to retrieve the CD.
CD-ROM or DVD device is not detected; driver is not loaded.	<ol style="list-style-type: none">1. CD-ROM drive is not connected properly or not properly terminated. Open the computer and check the drive cable.2. See "Non-Functioning Drive" Flowchart.
CD-ROM or DVD device is not detected or driver is not loaded.	Drive not properly connected or not properly configured. Refer to the documentation that came with the optional device.
Movie will not play in the DVD drive.	Movie may be regionalized for a different country. Refer to the documentation that came with the DVD drive.

Memory

Problem

System won't boot or does not function properly after installing additional memory modules.

Out of Memory error.

Memory count during POST is wrong.

Insufficient memory error during operation.

Unit is on but there is no video and the power LED is blinking red.

Possible Solution

Memory module is not the correct type or speed grade for the system. Replace module with the correct industry-standard for the computer. SPD-compliant 168-pin synchronous dynamic random access

1. Memory configuration may not be set up correctly; check memory configuration using Device Manager.
2. The computer has run out of memory for the application. Check the application documentation to determine the memory requirements.

Memory modules may not have been installed incorrectly or incorrect memory modules may have been used.

1. Too many Terminate and Stay Resident programs (TSRs) are installed. Delete any unnecessary TSRs.
2. There is not enough memory for the application. Check the memory requirements for the application or add more memory.

Memory not installed correctly in the computer and system not booting. Reinstall memory modules.

Network

Some common causes and solutions for network problems are listed in the following table. These guidelines do not discuss the process of debugging network cabling.

Problem	Possible Solution
The Remote Wakeup feature is not functioning.	<ol style="list-style-type: none">1. The feature is not available when using an AUI network connection; use an RJ-45 network connection.2. Remote Wakeup is not enabled. Use the network control application to enable Remote Wakeup.3. Check that WOL cable is connected (if applicable).
Network driver does not detect network controller.	Network controller is disabled. Run Computer Setup and enable network controller.
Network status link light does not turn on or flashes.	<ol style="list-style-type: none">1. No active network is detected. Check cabling and network equipment for proper connection.2. Network connection is not set up properly. Use the network control application to verify that the device is working properly.3. System is configured for AUI connection; link LED does not apply to AUI connections.4. Network driver is not properly loaded. Reinstall network drivers.5. System cannot autosense the network. Disable autosensing capabilities and force the system into the correct operating mode.
Diagnostics reports a failure.	<ol style="list-style-type: none">1. The cable is not securely connected or is attached incorrectly. Ensure that the cable is securely attached to the network connector and that the other end of the cable is securely attached to the correct device.2. There is a problem with the cable or a device at the other end of the cable. Ensure that the cable and device at the other end are operating correctly.3. The network controller is defective. Replace the controller or the system board.4. Network controller interrupt with an expansion board. Under the Computer Setup Advanced menu, change the resource settings for the board.
Diagnostics passes, but the computer does not communicate with the network.	<ol style="list-style-type: none">1. Network drivers are not loaded, or driver parameters do not match current configuration. Make sure the network drivers are loaded and that the driver parameters match the configuration of the network controller.2. The network controller is not configured for this computer. In Windows 95 or Windows NT, select the Network icon at the Control Panel.3. Network controller interrupt with an expansion board. Under the Computer Setup Advanced menu, change the resource settings for the board.

continued

Network Problem Continued

Problem

Network controller stopped working when an expansion board was added to the computer.

Possible Solution

1. Network drivers are not loaded or driver parameters do not match the current configuration. Make sure that the drivers are loaded and that the driver parameters match the configuration of the network controller.
2. The cable is not securely connected or is attached incorrectly. Ensure that the cable is securely attached to the network connector and that the other end of the cable is securely attached to the correct device.
3. Network controller interrupt with an expansion board. Under the Computer Setup Advanced menu, change the resource settings for the board.
4. Network drivers were accidentally deleted when the drivers for the new expansion board were installed, or the files containing the network drivers are corrupted. Reinstall the network drivers, using backup diskettes.

Network controller stopped working without apparent cause.

1. The files containing the network drivers are corrupted. Reinstall the network drivers, using backup diskettes.
2. The cable is not securely connected or is attached incorrectly. Ensure that the cable is securely attached to the network connector and that the other end of the cable is securely attached to the correct device.
3. The network controller is defective. Replace the network controller or system board.

Cannot connect to the network server when attempting Remote System Installation.

The network controller is not configured properly. Run Computer Setup and modify the Embedded NIC Settings.

System Setup utility reports unprogrammed EPROM.

1. Boot the workstation without the network drivers using a system boot diskette and reconfigure the controller.
2. Replace the controller.
3. Replace the system board.

Resolving Audio Hardware Conflicts

Hardware conflicts occur when two or more peripheral devices contend for the same signal lines or channels. Conflicts between the audio interface and another peripheral device may be due to the settings of the base I/O addresses, interrupts, or DMA channels. The audio interface typically has the following settings:

Item	Setting
Base I/O address	220H
FM Synthesizer I/O address	388-38Bh
Interrupt	IRQ 5
8-bit DMA	Channel 1

To resolve hardware conflicts:

1. Change the hardware settings of your audio card or the peripheral card in your system if the peripheral card is using the audio interface setting. You can change settings for integrated audio using Computer Setup.
2. If you are unsure of the settings of the peripheral cards, you can isolate the source of the problem by temporarily removing all cards and other essential cards such as the disk controller. After that, add the cards back one at a time until the card that is causing the conflict is found.

Problem

Sound does not come out of the speaker.

Possible Solution

Software volume control is turned down in Microsoft Sound System Control Panel, or CD-ROM or DVD volume control on the front or back of the computer is turned down.

1. Click Start, then select Programs, Accessories, Multimedia, Volume Control.
2. Turn the CD-ROM volume control knob on the front or back of the computer to increase the volume.

Troubleshooting Using Compaq Intelligent Manageability Features

The Local Alert Pop-Up Dialog notifies you of an impending or actual hardware failure. If the computer is connected to a network and the Compaq Insight Management Agents are installed and configured, an Simple Network Management Protocol (SNMP) trap (message) is sent to the specified SNMP-compliant management application.

The Local Alert Pop-Up Dialog also tells you the steps you need to take prior to a hardware failure to avoid loss of data and damage to the computer. The system administrator can create a customized action message that might include contact telephone or pager numbers.

To close the Local Alert Pop-Up Dialog, click the Close button. To retrieve fault information after closing the dialog, run Compaq Insight Personal Edition.

For more detailed information, refer to the online *Intelligent Manageability Guide*.

appendix **B**

POST ERROR MESSAGES - NUMBERED

Some Compaq computers have a complete series of POST error messages with code numbers assigned to them. Use the information below for those computers.

An error message results if the Power-On Self-Test (POST) encounters a problem. This test runs when the system is turned on, checking assemblies within the computer and reporting any errors found.

Screen Message	Beeps*	Probable Cause	Recommended Action
101-Option ROM Error	1L, 1S	System ROM checksum.	<ol style="list-style-type: none">1. Verify the correct ROM.2. Flash the ROM if needed.3. If an expansion card was recently added, remove it and see if the problem remains.4. Clear CMOS.5. If the message disappears, there may be a problem with the expansion card.6. Replace the system board.
102-System Board Failure	None	DMA, timers, etc.	<ol style="list-style-type: none">1. Clear CMOS.2. Remove expansion boards.3. Replace the system board.
103-System Board Failure	None	DMA, timers, etc.	<ol style="list-style-type: none">1. Clear CMOS.2. Remove expansion boards.3. Replace the system board.
150-SafePost Active	None	A PCI expansion card is not responding.	<ol style="list-style-type: none">1. Restart the computer.2. Disable SafePost.3. If the expansion card does not respond, replace the card.
162-System Options Not Set	2S	Configuration incorrect. RTC (real-time clock) battery may need to be replaced. Battery life is approximately 3 years.	Run Computer Setup (F10 Setup) Reset the date and time under Control Panel. If the problem persists, replace the RTC battery.

* L = Long, S = Short

continued

POST Error Messages *Continued*

Screen Message	Beeps*	Probable Cause	Recommended Action
163-Time & Date Not Set	2S	Invalid time or date in configuration memory. RTC (real-time clock) battery may need to be replaced. Battery life is approximately 3 years. CMOS jumper may not be properly installed.	Set the date and time under Control Panel. If the problem persists, replace the RTC battery. Check for proper placement of the CMOS jumper.
164-Memory Size Error	2S	Memory configuration is incorrect.	<ol style="list-style-type: none"> 1. Run Computer Setup (F10 Setup) or Windows utilities. 2. Make sure memory module(s) (if any) are installed properly. 3. Verify proper memory module type. 4. If third-party memory has been added, test using Compaq-only memory.
183-Invalid Processor Jumper Setting	2S	System board jumper improperly set.	Reset system board jumpers to match processor and bus speeds.
201-Memory Error	None	RAM failure.	<ol style="list-style-type: none"> 1. Run computer Setup (F10 Setup) or Windows utilities. 2. Ensure memory and continuity modules are installed correctly. 3. Verify proper memory module type. 4. Remove and replace memory module(s) one at a time to isolate faulty module. 5. Replace the faulty memory module(s). 6. If error persists after replacing memory modules, replace the system board.
202-Memory Type Mismatch	None	Memory modules do not match each other.	Replace memory modules with matched sets.
207-ECC Corrected Single Bit Errors in DIMM/SIMM Pair(s) X,X,... in Memory Socket(s) y,y	2S	Single Bit ECC error.	<ol style="list-style-type: none"> 1. Verify proper memory module type. 2. Try another memory socket. 3. Replace memory module if problem persists.

* L = Long, S = Short

continued

POST Error Messages *Continued*

Screen Message	Beeps*	Probable Cause	Recommended Action
212-Failed Processor	None	Processor has failed to initialize.	<ol style="list-style-type: none"> 1. Reseat the processor in its socket. 2. If the processor does not respond, replace it.
213-Incompatible DIMM Module in DIMM Socket(s) X,X	2S	A DIMM module in DIMM socket identified in the error message is missing critical SPD information, or is incompatible with the chipset.	<ol style="list-style-type: none"> 1. Verify proper memory module type. 2. Try another memory socket. 3. Replace DIMM with a module conforming to the SPD standard.
214-Memory Device Failure. Error Code: XX Memory Module Socket(s):XX	None	A specific error has occurred in a RDRAM device installed in the identified socket.	<ol style="list-style-type: none"> 1. Verify proper memory module type. 2. Try another memory socket. 3. Replace memory module if problem persists.
301-Keyboard Error	None	Keyboard failure.	<ol style="list-style-type: none"> 1. Reconnect keyboard with computer turned off. 2. Check connector for bent or missing pins. 3. Ensure that none of the keys are depressed. 4. Replace keyboard.
304-Keyboard or System Unit Error	None	Keyboard failure.	<ol style="list-style-type: none"> 1. Reconnect the keyboard with computer turned off. 2. Ensure that none of the keys are depressed. 3. Replace keyboard. 4. Replace system board.
401-Parallel Port 1 Address Assignment Conflict	2S	IRQ address conflicts with another device.	Reset the IRQ.
403-Parallel Port 3 Address Assignment Conflict	2S	IRQ address conflicts with another device.	Reset the IRQ.
404-Parallel Port Address Conflict Detected	2S	Both external and internal ports are assigned to parallel port X.	<ol style="list-style-type: none"> 1. Remove any parallel expansion cards. 2. Clear CMOS. 3. Reconfigure card resources and/or run Computer Setup (F10 Setup).

* L = Long, S = Short

continued

POST Error Messages Continued

Screen Message	Beeps*	Probable Cause	Recommended Action
410-Audio Interrupt Conflict	2S	IRQ address conflicts with another device.	Reset the IRQ.
411-Network Interface Card Interrupt Conflict	2S	IRQ address conflicts with another device.	Reset the IRQ.
501-Display Adapter Failure	1L, 2S	Graphics display controller.	<ol style="list-style-type: none"> 1. Reseat the graphics card (if applicable). 2. Clear CMOS. 3. Verify the monitor is attached and turned on. 4. Replace the graphics controller.
601-Diskette Controller Error	None	Diskette controller circuitry or floppy drive circuitry incorrect.	<ol style="list-style-type: none"> 1. Run Computer Setup (F10 Setup). 2. Check and/or replace cables. 3. Clear CMOS. 4. Replace diskette drive. 5. Replace the system board.
602-Diskette Boot Record Error	None	Diskette in drive A not bootable.	Replace the diskette.
605-Diskette Drive Type Error	2S	Mismatch in drive type.	<ol style="list-style-type: none"> 1. Run Computer Setup (F10 Setup) or Windows NT, Windows 95, 98, or 2000 utilities. 2. Disconnect any other diskette controller devices (tape drives). 3. Clear CMOS.
610-External Storage Device Failure	None	External tape drive not connected.	Reinstall tape drive or press F1 and allow system to reconfigure without the drive.
611-Primary Floppy Port Address Assignment Conflict	2S	Configuration error.	<ol style="list-style-type: none"> 1. Run Computer Setup (F10 Setup). 2. Remove expansion cards. 3. Clear CMOS.
612-Secondary Floppy Port Address Assignment Conflict	2S	Configuration error.	<ol style="list-style-type: none"> 1. Run Computer Setup (F10 Setup). 2. Remove expansion cards 3. Clear CMOS.

* L = Long, S = Short
continued

POST Error Messages *Continued*

Screen Message	Beeps*	Probable Cause	Recommended Action
660-Display Cache is Detected Unreliable	None	Integrated video controller display cache not working properly and will be disabled.	Replace system board if minimal video degrading is an issue.
912-Computer Cover Has Been Removed Since Last System Start Up	None		No action required.
914-Hood Lock Coil is not Connected	None	Hood lock mechanism is missing or not connected.	<ol style="list-style-type: none">1. Reconnect or replace hood locking mechanism.2. Reseat or replace hood locking mechanism cable.
916-Thermal Sensor from Processor Heatsink is not Connected.	None	Processor heatsink cable not connected to system board.	Reseat or replace the processor heatsink cable going to the system board.
917-Expansion Riser not Detected	None	Riser board not seated or not installed.	Install riser board if missing or remove and reseat to ensure good connection.
1151-Serial Port 1 Address Conflict Detected	2S	Both external and internal serial ports are assigned to COM1.	<ol style="list-style-type: none">1. Remove any Comm port expansion cards.2. Clear CMOS.3. Reconfigure card resources and/or run Computer Setup (F10 Setup).Run Computer Setup or Windows utilities.
1152-Serial Port 2 Address Conflict Detected	2S	Both external and internal serial ports are assigned to COM2.	<ol style="list-style-type: none">1. Remove any Comm port expansion cards.2. Clear CMOS.3. Reconfigure card resources and/or run Computer Setup (F10 Setup).Run Computer Setup or Windows utilities.
1155- Serial Port Address Conflict Detected	2S	Both external and internal serial ports are assigned to same IRQ.	<ol style="list-style-type: none">1. Remove any Comm port expansion cards.2. Clear CMOS.3. Reconfigure card resources and/or run Computer Setup (F10 Setup). Run Computer Setup or Windows utilities.
1201-System Audio Address Conflict Detected	2S	Device IRQ address conflicts with another device.	Reset the IRQ.

* L = Long, S = Short
continued

POST Error Messages *Continued*

Screen Message	Beeps*	Probable Cause	Recommended Action
1202-MIDI Port Address Conflict Detected	2S	Device IRQ address conflicts with another device.	Reset the IRQ.
1203-Game Port Address Conflict Detected		Device IRQ address conflicts with another device.	Reset the IRQ.
1611- Fan failure detected	None	Chassis fan not conneted to the system board.	<ol style="list-style-type: none">1. Reconnect the fan.2. Replace the fan.3. Replace the system board.
1720-SMART Hard Drive Detects Imminent Failure	None	Hard drive is about to fail. (Some hard drives have a firmware patch that will fix an erroneous error message.)	<ol style="list-style-type: none">1. Determine if hard drive is giving correct error message. Run the Drive Protection System test available.2. Apply firmware patch if applicable.3. Back up contents and replace hard drive.
1721-SMART SCSI Hard Drive Detects Imminent Failure	None	Hard drive is about to fail. (Some hard drives have a firmware patch that will fix an erroneous error message.)	<ol style="list-style-type: none">1. Determine if hard drive is giving correct error message. Run the Drive Protection System test available.2. Apply firmware patch if applicable.3. Back up contents and replace hard drive.
1771-Primary Disk Port Address Assignment Conflict	2S	Internal and external hard drive controllers are both assigned to the primary address.	<ol style="list-style-type: none">1. Remove any Comm port expansion cards.2. Clear CMOS.3. Reconfigure card resources and/or run Computer Setup (F10 Setup).
1772-Secondary Disk Port Address Assignment Conflict	2S	Internal and external hard drive controllers are both assigned to the primary address.	<ol style="list-style-type: none">1. Remove any Comm port expansion cards.2. Clear CMOS.3. Reconfigure card resources and/or run Computer Setup (F10 Setup).

* L = Long, S = Short
continued

POST Error Messages *Continued*

Screen Message	Beeps*	Probable Cause	Recommended Action
1780-Disk 0 Failure	None	Hard drive/format error.	<ol style="list-style-type: none">1. Run Computer Setup (F10 Setup).2. Clear CMOS.3. Check cables/jumper settings.4. Run hard drive diagnostics.5. Disconnect additional drives.6. Run the Drive Protection System test if available.7. Replace the hard drive.
1781-Disk 1 Failure	None	Hard drive/format error.	<ol style="list-style-type: none">1. Run Computer Setup (F10 Setup).2. Clear CMOS.3. Check cable seating/jumper settings.4. Run hard drive diagnostics.5. Disconnect additional drives.6. Run the Drive Protection System test if available.7. Replace the hard drive.
1782-Disk Controller Failure	None	Hard drive circuitry error.	<ol style="list-style-type: none">1. Run Computer Setup (F10 Setup).2. Clear CMOS.3. Check cable seating /jumper settings.4. Run hard drive diagnostics.5. Disconnect additional drives.6. Run the Drive Protection System test if available.7. Replace the hard drive.8. Replace the system board.

* L = Long, S = Short
continued

POST Error Messages *Continued*

Screen Message	Beeps*	Probable Cause	Recommended Action
1790-Disk 0 Failure	None	Hard drive error or wrong drive type.	<ol style="list-style-type: none">1. Run Computer Setup (F10 Setup).2. Clear CMOS.3. Check cable seating /jumper settings.4. Run hard drive diagnostics.5. Disconnect additional drives.6. Confirm drive is supported on this computer (Large drive ROM support.)7. Run the Drive Protection System test if available.8. Replace the hard drive.9. Replace the system board.
1791-Disk 1 Failure	None	Hard drive error or wrong drive type.	<ol style="list-style-type: none">1. Run Computer Setup (F10 Setup).2. Clear CMOS.3. Check cable seating /jumper settings.4. Run hard drive diagnostics.5. Disconnect additional drives.6. Confirm drive is supported on this computer (Large drive ROM support).7. Run the Drive Protection System test if available.8. Replace the hard drive.9. Replace the system board.
1792-Secondary Disk Controller Failure	None	Hard drive circuitry error.	<ol style="list-style-type: none">1. Run Computer Setup (F10 Setup).2. Clear CMOS.3. Check cable seating /jumper settings.4. Run hard drive diagnostics.5. Disconnect additional drives.6. Run the Drive Protection System test if available.7. Replace the hard drive.

* L = Long, S = Short
continued

POST Error Messages *Continued*

Screen Message	Beeps*	Probable Cause	Recommended Action
1793-Secondary Controller or Disk Failure	None	Hard drive circuitry error.	<ol style="list-style-type: none"> 1. Run Computer Setup (F10 Setup). 2. Clear CMOS. 3. Check cable seating /jumper settings. 4. Run hard drive diagnostics. 5. Disconnect additional drives. 6. Run the Drive Protection System test if available. 7. Replace the hard drive.
1800-Temperature Alert	None	Internal temperature exceeds specification.	<ol style="list-style-type: none"> 1. Check that computer air vents are not blocked and cooling fan is running. 2. Verify processor speed selection. 3. Replace the processor. 4. Replace the system board.
1801	None	Processor not supported by ROM Bios.	Upgrade Bios to proper version.
Audible	1L, 3S	System ROM is bad; system is running in Failsafe Boot Block mode.	Reflash the ROM using a ROMPaq diskette. Refer to the "Failsafe Boot Block ROM" section of the <i>Software Reference Guide</i> .
Audible	2S	Power-on successful.	None
Flashing Caps Lock LED on Keyboard	1L, 2S	Graphics controller not present or incorrectly initialized.	<ol style="list-style-type: none"> 1. Clear CMOS. 2. If graphics card has been added, remove and reseat.
Flashing Num Lock LED on Keyboard	1S, 2L	System memory not present.	<ol style="list-style-type: none"> 1. Check memory module. 2. Remove and reseat memory module. 3. See "Memory Problems" in Appendix A.
Num Lock LED on Keyboard	None	Failed Boot Block.	Reflash the ROM using a ROMPaq diskette.
Flashing Scroll Lock LED on Keyboard	2L, 1S	System board hardware failure (prior to video).	Replace system board.

* L = Long, S = Short
continued

POST Error Messages *Continued*

Screen Message	Beeps*	Probable Cause	Recommended Action
Green Power LED Blinks Once per Second	None	Computer in normal Suspend mode.	None
Green Power LED ON	None	Computer on.	None
Invalid Electronic Serial Number	None	Electronic serial number has become corrupted.	Run Computer Setup (F10 Setup). If Setup already has data in the field or will not allow the serial number to be entered, download and run SP5572.EXE (SNZERO.EXE).
Flashing Power and Hard Drive Green LEDs	None	Unseated riser board.	<ol style="list-style-type: none">1. Remove riser board.2. Wipe connector.3. Reinstall riser board.
Red Power LED Blinks Every 2 or more Seconds	None	Power supply overloaded.	<ol style="list-style-type: none">1. Push in power button. LED should be green.2. Remove all AC power from computer, wait 30 seconds, then apply power.3. Remove load from power supply by removing options one at a time until computer runs.4. Check for damage to system board.5. Replace system board.6. Replace power supply.
Red Power LED Blinks Every Second	None	System memory error.	<ol style="list-style-type: none">1. Check memory module.2. Remove and reseat memory module.3. See the "Solving Memory Problems" section of this guide.
Red power LED ON	None	Processor unseated.	Reseat processor in system board.
XXOOOYZZ Parity Check	None	Parity RAM failure.	Run Computer Setup and Diagnostic Utilities.

* L = Long, S = Short

appendix **C**

POST ERROR MESSAGES - NOT NUMBERED

Some Compaq computers have a complete series of POST error messages that no code numbers assigned to them. Use the information below for those computers.

An error message results if the Power-On Self-Test (POST) encounters a problem. This test runs when the system is turned on, checking assemblies within the computer and reporting any errors found. POST checks the following assemblies to ensure that the computer system is functioning properly:

- Keyboard
- System board
- Memory modules
- Video memory
- Diskette drives
- Hard drive
- Power supply

POST also detects the type of mass storage devices installed in the computer.

If POST finds an error in the system, an error condition is indicated by an audible and/or visual message. The following table gives explanations of the error codes and recommended courses of action.



An external speaker must be installed into the speaker output connector to hear audible beeps during POST.

Error message	Probable Cause	Recommended Action
Diskette Drive A or B Error	Drive A: or B: is present, but fails the BIOS POST diskette tests.	<ol style="list-style-type: none"> 1. Run Setup. 2. Replace the signal cable. 3. Replace the drive.
Extended RAM Failed at Offset, <i>nnn</i>	Extended memory is not working or is not configured properly.	<ol style="list-style-type: none"> 1. Replace the memory modules. 2. Replace the system board.
Failing Bits <i>nnn</i>	<i>nnn</i> is a map of the bits at the RAM address which failed the memory test.	<ol style="list-style-type: none"> 1. Run Setup. 2. Replace the system board.
Fixed Disk 0 or 1 Failure	Hard drive is not working or is not configured properly.	<ol style="list-style-type: none"> 1. Run Setup. 2. Replace the signal cable. 3. Replace the hard drive.
Fixed Disk Controller Failure	Hard drive is not working or is not configured properly.	<ol style="list-style-type: none"> 1. Run Setup. 2. Replace the system board.
Incorrect Drive A Type	Type of diskette in drive A: is not correctly identified.	<ol style="list-style-type: none"> 1. Run Setup. 2. Replace the diskette drive.
Invalid NVRAM Media Type	Problem with NVRAM (CMOS) access.	Replace the system board.
Keyboard Controller Error	Keyboard, I/O keyboard controller (on system board), or mouse error.	<ol style="list-style-type: none"> 1. Replace the keyboard. 2. Replace the mouse. 3. Replace the system board.
Keyboard Error	Keyboard, I/O keyboard controller (on system board), or mouse error.	<ol style="list-style-type: none"> 1. Replace the keyboard. 2. Replace the mouse. 3. Replace the system board.
Operating System Not Found	Operating system cannot be located on either drive A: or C:.	Run Setup.
Parity Check 1	Parity error found in the system bus.	<ol style="list-style-type: none"> 1. Run Setup. 2. Replace the memory modules. 3. Replace the system board.
Parity Check 2	Parity error found in the I/O bus.	<ol style="list-style-type: none"> 1. Run Setup. 2. Replace the ISA board (modem).
Real Time Clock Error	Real-time clock fails BIOS test.	Replace the system board.
System Battery is Dead	RTC battery is dead.	<ol style="list-style-type: none"> 1. Replace the RTC battery. 2. Run Setup.

Continued

POST Error Messages Continued

Error message	Probable Cause	Recommended Action
System BIOS Shadowed	System BIOS copied to Shadow RAM.	Status message. No action required.
System Cache Error	RAM cache failed the BIOS test.	Run Setup.
System CMOS Checksum Bad	CMOS is corrupted or modified incorrectly.	Run Setup.
System RAM Failed at Offset, <i>nnn</i>	System RAM failed.	Replace memory modules.
System Timer Error	DMA, timers, etc.	Replace the system board.
UMB Upper Limit Segment Address <i>nnn</i>	Displays the address <i>nnn</i> of the upper limit of Upper Memory Blocks, indicating released segments of the BIOS.	Status message. No action required.
Video BIOS Shadowed	Video BIOS successfully copied to shadow RAM.	Status message. No action required.