

Handling Precautions



CAUTION

High potential static charge may cause damage to the integrated circuits on the board. Before handling the mainboard outside of its protective packaging, ensure that there is no static electric charge in your body.

Danger of explosion with incorrectly replaced battery: Replace only with the same or equivalent type recommended by the manufacturer.

There are some basic precautions when handling the mainboard or other computer components:

- ◆ Keep the board in its anti-static bag until you are ready to install it.
- ◆ Protect your board from static electricity by well grounding of your body and the equipment during the installation, such as wearing a grounded wrist strap.
- ◆ Always handle the board by its edges.
- ◆ Do not touch the components on the boards.
- ◆ Ensure the system power is completely turn-off before doing any installation work.

Notice to Customers

The information in this User's Guide contains with no liability whatsoever, and disclaims any express or implied warranty, relating to sale and/or use of products including liability or warranties relating to fitness for a particular purpose, or infringement of any patent, copyright or other intellectual property right. We shall not be liable for any loss or profits, loss of business, loss of use or data, interruption of business, or for indirect, special, incidental, or consequential damages arising from any defect or error in this User's Guide or product.

We retains the right to make changes on this User's Guide and product descriptions at any time, without notice.

Trademarks™

Intel®, **Pentium®** are registered trademarks of Intel Corporation.

IBM, **IBM PC**, **IBM PC/AT**, **PC-DOS**, **OS/2** and **OS/2 WARP** are registered trademarks of International Business Machines Corporation.

MS-DOS, **Windows** and **Windows 95** are registered trademarks of Microsoft Corporation.

AWARD BIOS is a product of Award Software International Inc.

Sound Blaster and **Blaster** are registered trademarks in U.S.A. and/or other countries.

SB-LINK DynaRAM and WavEffects are trademarks of Creative Technology Ltd.

Third-party brands and names mentions in this User's Guide are the property of their respective owners.

User's Guide Revision : 1.01

Release Date : July 1998

Copyright © 1998, All rights reserved.

Table of Contents

FEATURES OF THE BOARD.....	1
OVERVIEW	1
AUTO JUMPER YES	1
FEATURES SUMMARY	1
MOTHERBOARD INSTALLATION.....	3
INSTALLATION PRECAUTIONS.....	3
A QUICK INTRODUCTION	3
JUMPERS SETTING	3
CPU INSTALLATION.....	4
INSTALLING SYSTEM MEMORY (RAM).....	5
EXPANSION CARDS INSTALLATION.....	7
CONNECTING EXTERNAL CONNECTOR	7
REPLACING BATTERY.....	10
QUICK INSTALLATION GUIDE.....	11
QUICK REFERENCE OF YOUR MOTHERBOARD	16
AWARD BIOS AND CMOS SETUP UTILITY	20
GETTING START.....	20
ENTERING SETUP.....	20
GETTING HELP	21
THE MAIN MENU.....	21
STANDARD CMOS SETUP	23
BIOS FEATURES SETUP	25
CHIPSET FEATURES SETUP	27
POWER MANAGEMENT SETUP	28
PNP/PCI CONFIGURATION	30
INTEGRATED PERIPHERALS SETUP.....	32
LOAD BIOS DEFAULTS	34
LOAD SETUP DEFAULTS	34
PASSWORD SETTING.....	34
IDE HDD AUTO DETECTION	34
SAVE AND EXIT SETUP.....	34
EXIT WITHOUT SAVING.....	34
MOTHERBOARD TECHNICAL SPECIFICATION.....	35
ENVIRONMENT	35
DIMENSIONS AND WEIGHT.....	35
ELECTRICAL SPECIFICATION	35
POWER CONSUMPTION.....	35
REQUEST FOR TECHNICAL SUPPORT	36

FEATURES OF THE BOARD

Overview

Congratulations on purchasing the highest performance Pentium® motherboard. With the advanced technologies available today, this motherboard is designed to run Intel's Pentium® processors at speeds up to 233 MHz. The on-board system memory consists of SIMM and DIMM that gives you the most flexibility for system design. It supports up to 256 MB of DRAM using standard 72-pin SIMM sockets that accept either Fast Page Mode (FPM) and Extended Data Out (EDO) memory. In addition, two unbuffered, 3.3 Volts, 168-pin SDRAM sockets are also included for up to 256MB Synchronous Dynamic Memory support. A 321-pin, type 7, Zero Insertion Force (ZIF) socket allows an easy upgrade path for the future Pentium Overdrive® processors.

This motherboard utilizes Intel's 82430TX PCI chipset. The Intel 82371AB PCI/ISA IDE Xccelerator (PIIX4) provides an integrated Bus Mastering IDE controller with two high performance IDE interfaces for up to four IDE devices (such as hard drives or CD-ROM) and "Ultra 33" Synchronous DMA mode transfers up to 33Mbytes/sec. The integrated I/O controller integrates the standard PC I/O functions: floppy interface, two FIFO serial ports, one EPP/ECP capable parallel port, and support for an IrDA and Consumer Infra Red compatible interface.

The three on-board 32-bit PCI local bus slots allows a higher bandwidth data path, which serves as a super highway, for intensive data-movement such as video or networking. The BIOS support PCI bridge user configuration, which allows for further expansion of the system with PCI peripherals. And the three 16-bit ISA slots allow this board backward hardware compatible with the older expansion card. A total of six expansion slots may be populated with full lengths add-in cards, since one PCI and ISA slot share the same chassis I/O panel.

Auto Jumper Yes

This motherboard (5STX-J98) is one of our "Auto Jumper Yes" series, which eliminates the necessity for the user to be bored by jumper settings on the motherboard. It is capable of detecting the CPU brand, and setting the appropriate CPU core voltage and speed according to instructions from the user through CMOS setup menu. In contrast to "Jumperless", "Auto Jumper Yes" allows switching to manual mode that enables physical jumpers on the mainboard, so as to prevent the potential impacts on jumperless boards from future CPU specifications. On the other hand, pressing "F" to clear CMOS setting and "J" to re-detect CPU during power on the system, to avoid the difficulties to reset the CMOS data.

Features Summary

This motherboard comes with following features:

- Supports Intel Pentium® Processor up to 233MHz, which included the newest MMX CPU.
- Intel 430TX PCIsset, including and 82371AB PCI ISA IDE Xccelerator (PIIX4).
- Supports "Auto Jumper Yes" for detecting all brands CPU configurations.
- WAKEUP-LINK interface header supporting Intel Wake-On-LAN
- SB-LINK interface header supporting Creative™ AWE64D PCI 3D sound card
- TB-LINK interface headers supporting TOMATO™ SCE8/SCV6 sound card using the Creative™ Audio chip.

- CPU fan will power off and blinking LED automatically in sleep mode.
- PnP BIOS with support for power management, enhanced IDE/SCSI features and desktop management interface (DMI) which allows higher level of hardware compatibility.
- Flash BIOS for a more easy upgrade path.
- Up to 2 each 72-pin SIMM sockets, supports up to 256 MB DRAM in two banks, which included FPM, EDO DRAM types
- Two high speed unbuffered synchronous dynamic RAM sockets
- Three 16-bit ISA expansion slots and three 32-bit PCI expansion slots.
- Integrated two PCI bus master IDE controller with two on-board connectors supports up to four IDE devices such as Hard Disk, CD-ROM or Tape Backup drives. Supports "Ultra 33" Synchronous DMA mode transfers up to 33 Mbytes/sec.
- Integrated I/O chipset featuring one floppy disk controller, two 16550 UART compatible serial ports, one high speed EPP/ECP capable parallel port, one Infra Red port.
- Supports "Modems Ring On" (Requires ATX power supply and External COM2)
- Two USB ports for serial transfers at 12 or 1.5Mbit/sec. It supports legacy keyboard and mouse

MOTHERBOARD INSTALLATION

INSTALLATION PRECAUTIONS

During installation and initial test, use caution to avoid personal injury and damage to wiring due to sharp pins on connectors and printed circuit assemblies, rough chassis edges and corners, and hot components. Adhere to warnings and limitations regarding accessibility into areas designated only for authorized technical personnel.

A QUICK INTRODUCTION



To Install and operate your the new motherboard, you must follow the steps below:

1. Set Jumpers on the motherboard
2. Install the CPU with cooling fan
3. Install RAM modules
4. Connect cables, wires and power connector
5. Install expansion cards

Jumpers Setting

There are several user-adjustable jumpers on the board which allow you to configure your system to match your requirements. This chapter contains the information on the various jumpers settings and connector on your motherboard.

Jumpers

Jumpers are used to make several hardware settings on the motherboard. From the “Map of the Motherboard” shown above, you can identify the location of the jumpers. There are two kinds of jumper on-board, 2-pin jumper and 3-pin jumper. On the symbol of jumper likes “”, “” inside stands for pin 1. To set a jumper, a black cap containing metal contacts is placed across the jumper pin/s according to your required configuration. The jumper settings will also be described numerically such as [open] for open, [short] for short, [1-2] for connect pins 1&2, [2-3] for connects pins 2&3 respectively.

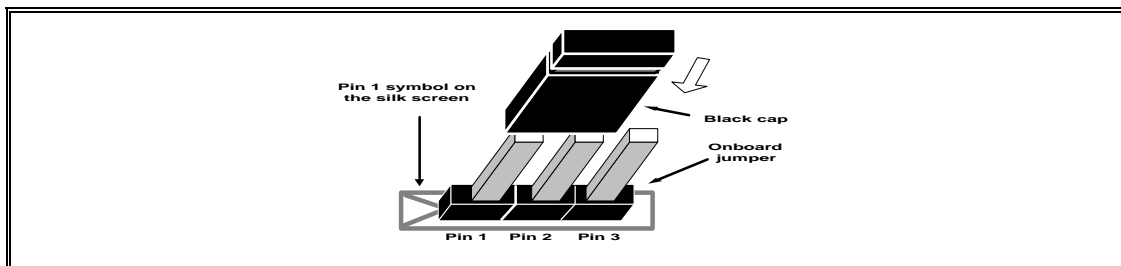

CAUTION

Users are not recommended to change any jumpers in it's default setting listed on this User's Guide. Changing the jumper settings improperly may affect the system performance.

CPU Installation

The motherboard provides a 321-pin, type-7, ZIP socket. The CPU should have a fan attached to it to prevent overheating. If this is not the case then purchase a fan before you turn-on the system.

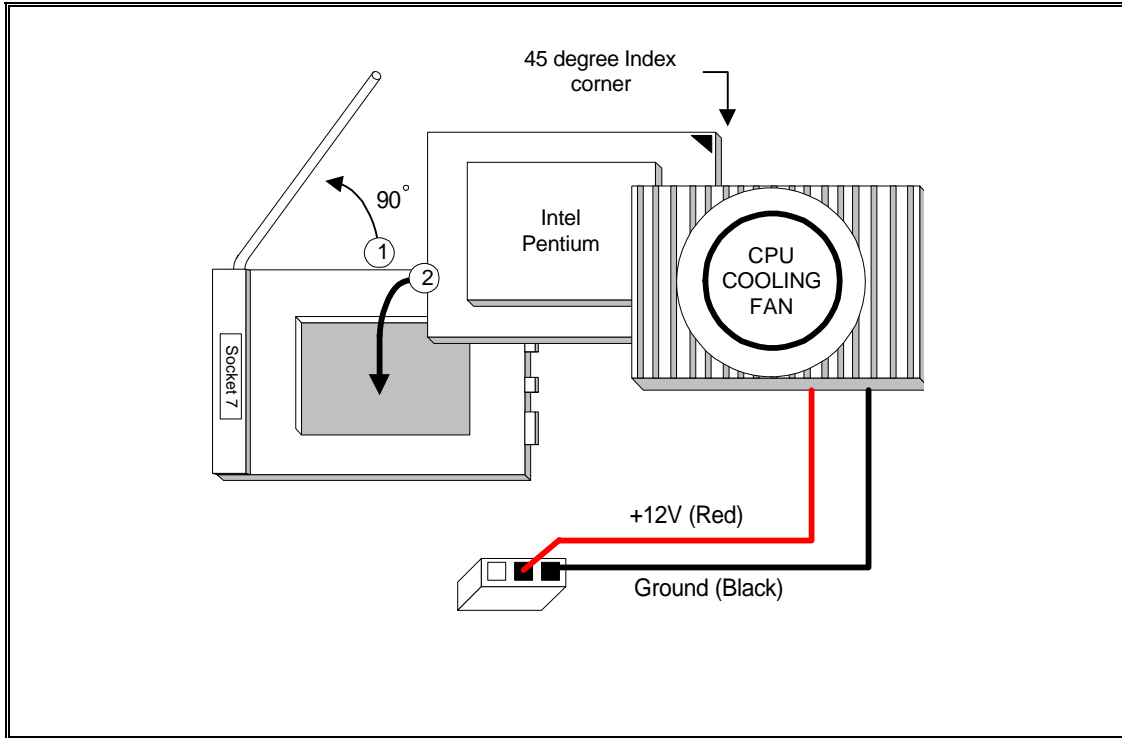

CPU Installation Diagram

! CAUTION

Without a effective cooling fan, the CPU can overheat and cause damage to both the CPU and the motherboard.

INSTALLING SYSTEM MEMORY (RAM)

The motherboard supports two 72-pin SIMMs (Single-In-Line Memory Modules) from 8MB up to 256MB memory size and two 168-pin DIMM. The two 72-pin SIMMs sockets are divided into two memory banks, Bank 0 and Bank 1, and each bank has two SIMM sockets which accept either FPM or EDO DRAM module.

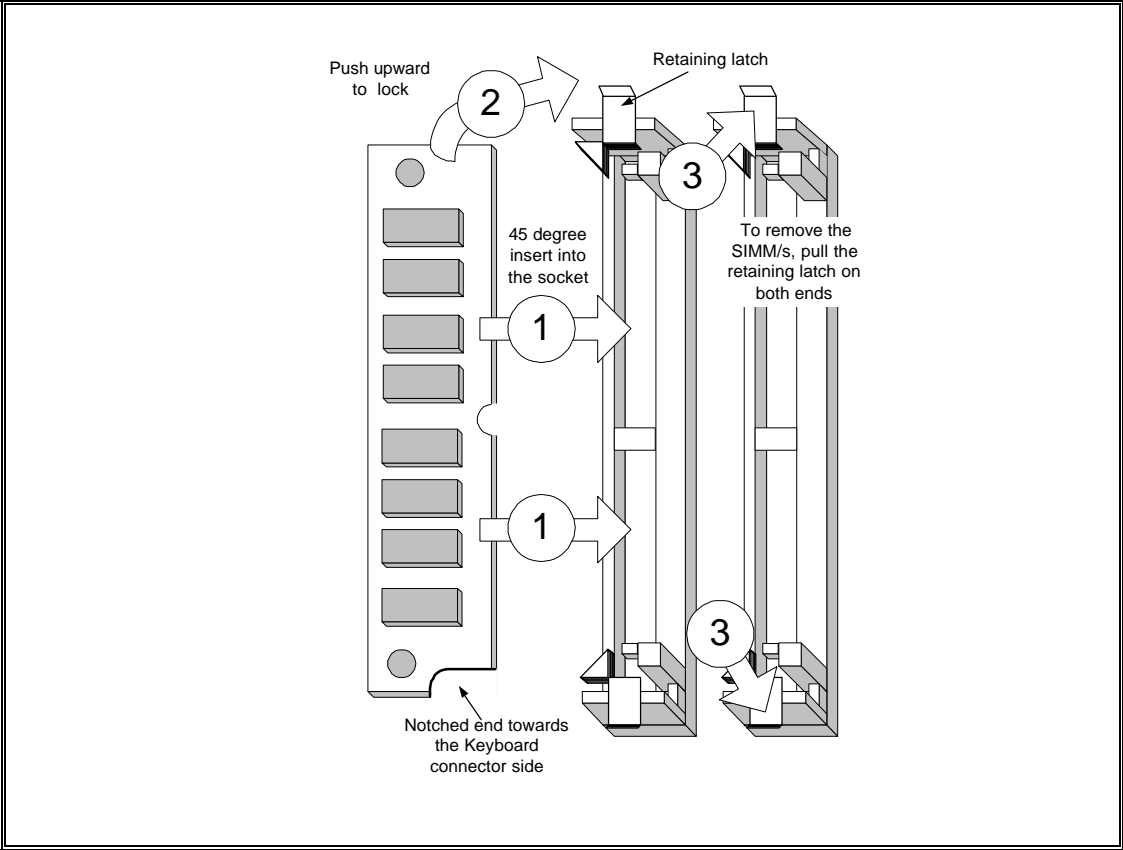

SIMM Module Installation Diagram

! CAUTION

Each bank must have the same size and type of memory module installed in pairs.

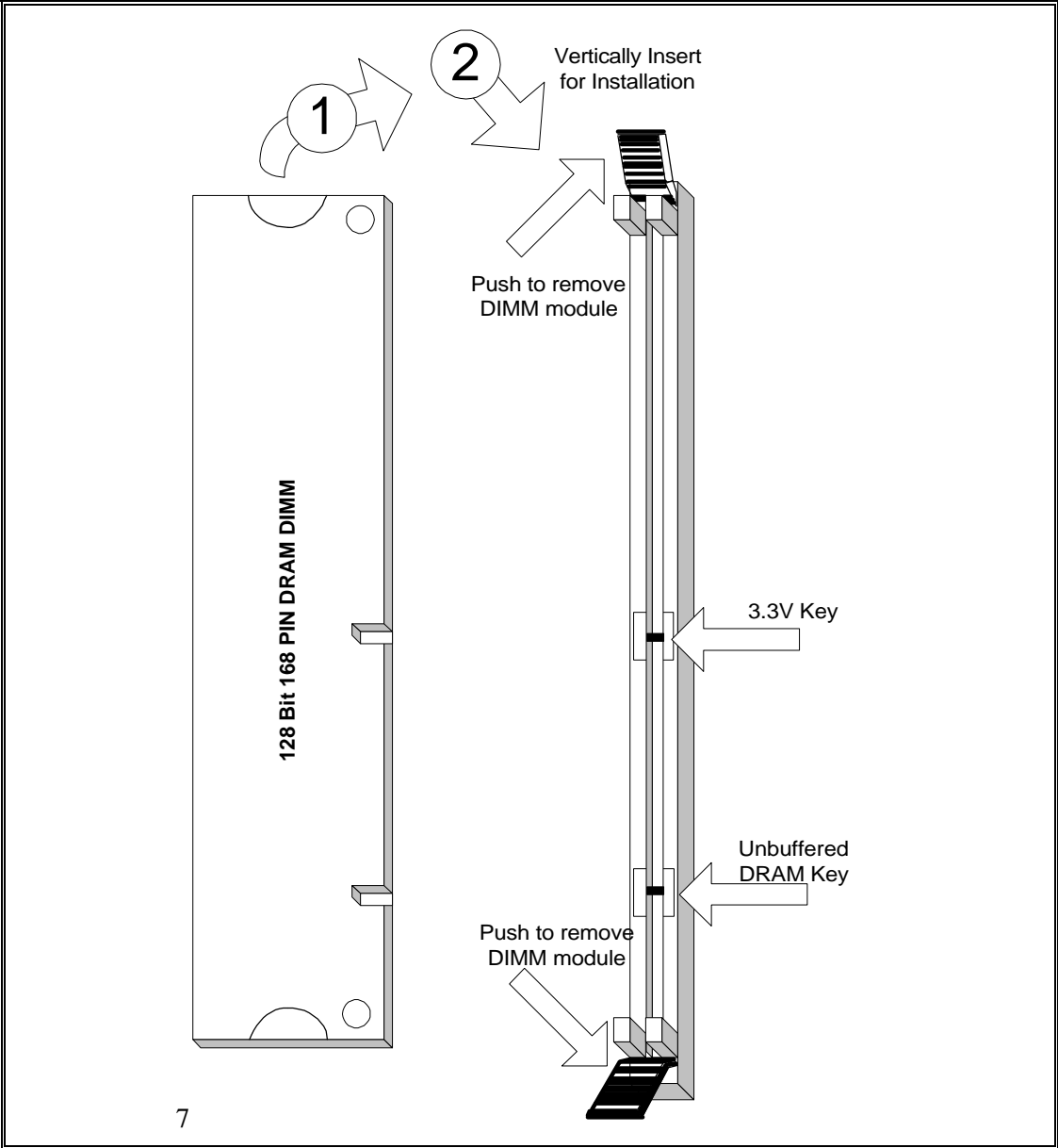

168-Pin SDRAM Module Installation Diagram

CAUTION

SDRAM Module cannot be used together with the SIMMs Module.

EXPANSION CARDS INSTALLATION

At the most of beginning, you must read your expansion card documentation on any hardware and software settings that may be required. The installation procedures are summarized as below:

1. Read the User's Guide/Manual of your expansion card.
2. If necessary, set any jumpers on your expansion card.
3. Power-off the system and then disconnected the power cord.
4. Remove your computer's cover.
5. Remove the metal bracket from one of the empty slot, ISA or PCI, corresponding to the type of expansion card.
6. Carefully align the card's connectors and press firmly, make sure that the connection is good.
7. Secure the card on the slot.
8. Replace the computer's cover.
9. Setup the BIOS configuration if necessary.
10. Install the required software drivers for your expansion card.

CAUTION

Before adding or removing any expansion card or other system components, make sure that you unplug your system power supply. Failure to do so may cause damage of your motherboard and expansion cards

CONNECTING EXTERNAL CONNECTOR

AT Power Connector

A 12-Pin power supplies provide two plugs incorporates standard $\pm 5V$ and $\pm 12V$, each containing six wires, two of which are black. Orient the connectors so that the black wires are together.

Pin	Signal Name	Pin	Signal Name
1	Power Good Signal	7	Ground
2	+5V	8	Ground
3	+12V	9	-5V
4	-12V	10	+5V
5	Ground	11	+5V
6	Ground	12	+5V

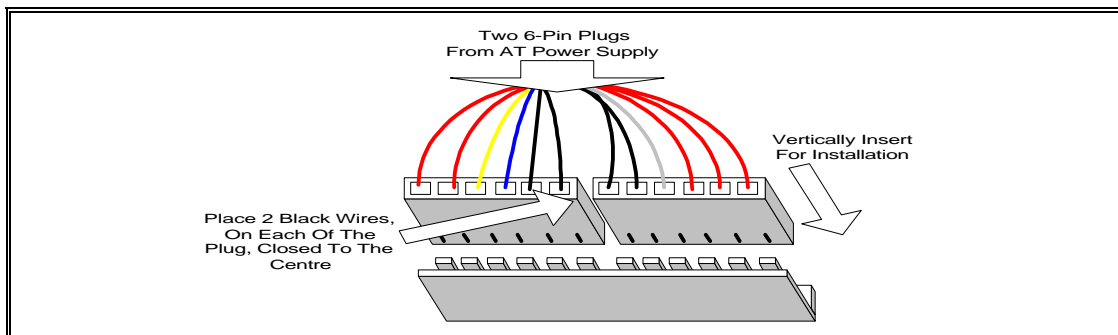

AT Power Connector Installation

ATX Power Connector

A single 20-pin connector incorporates standard $\pm 5V$ and $\pm 12V$, optional 3.3V and soft-power signals. With a power supply supports remote power on/off, the motherboard can turn off the system power through software control, such as the shutdown in Windows 95 Start menu. The system BIOS will turn the system power off when it receives the proper APM command from the OS. APM must be enabled in the system BIOS and OS in order for the soft-off feature to work correctly.

Pin	Signal Name	Pin	Signal Name
1	+3.3V	11	+3.3V
2	+3.3V	12	-12V
3	Ground	13	Ground
4	+5V	14	PW_ON
5	Ground	15	Ground
6	+5V	16	Ground
7	Ground	17	Ground
8	PWRGOOD	18	-5V
9	+5VSB	19	+5V
10	+12V	20	+5V

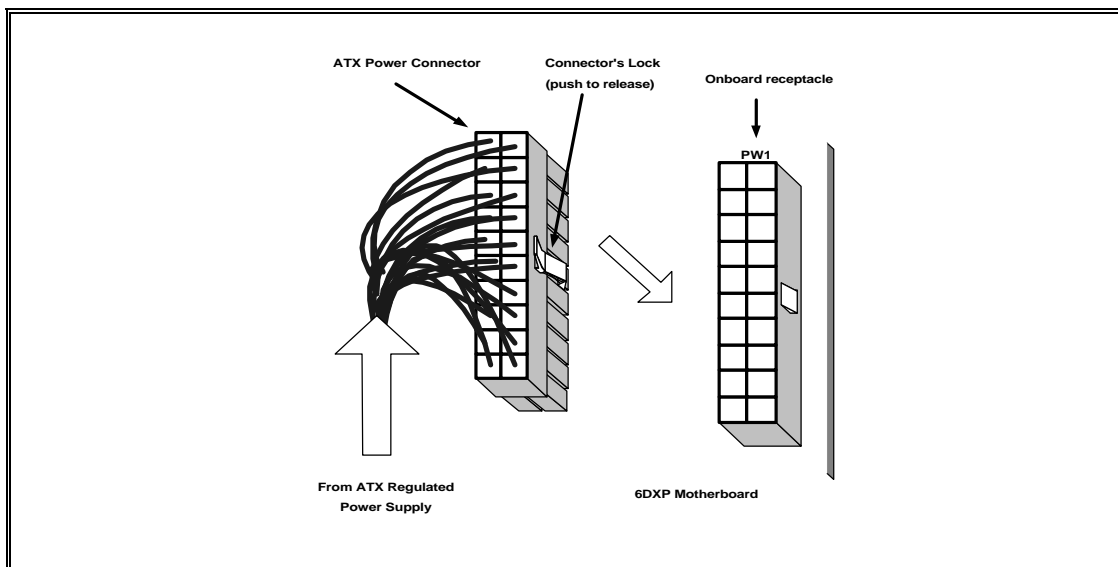

ATX Power Connector Installation

Floppy Drive Connector

This 34-pin connector supports the provided floppy drive ribbon cable. After connecting the single end to the on-board "FLOPPY" connector, connect the remaining plugs on the other end to the floppy drives correspondingly.

IDE Connectors

The two on-board IDE connectors support the provided 40-pin IDE hard disk ribbon cable. After connecting the single end to the board, connect the two remaining plugs at the other end of your hard disk(s). If you install two hard disks, you must configure the two drives by setting its jumpers according to the documentation of your hard disk. Also, you may connect the two hard disks to be both Masters using one ribbon cable on the primary IDE connector and one on the secondary IDE connector.

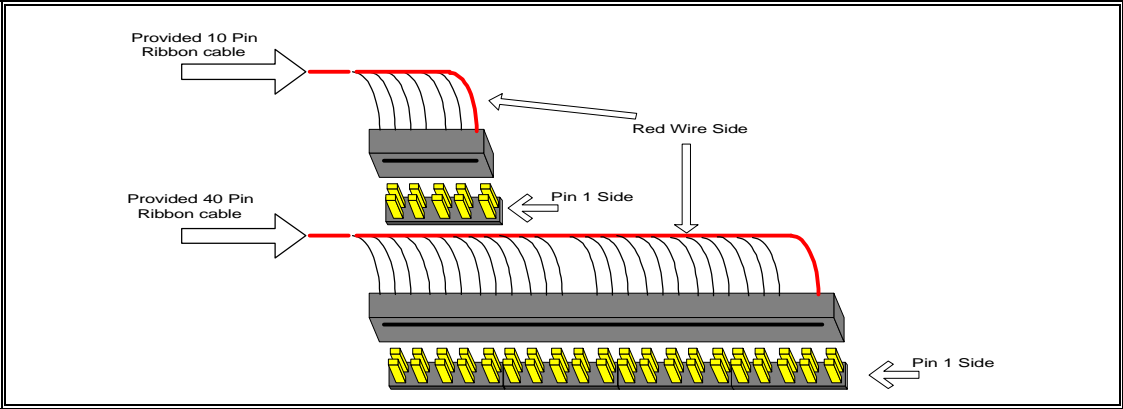

Ribbon cable Installation Example

! NOTICE

For the flat ribbon cable connection, please make sure that the pin 1 of the ribbon cable (the red wire side of the cable) is correctly connected to the on-board connector’s pin 1 as shown on the “Map of the Motherboard”.

Front Panel Function Connectors

All the front panel indicator, speaker, and switch functions are grouped into a on-board 26-pin connector, JP10. Front panel features supported include:

- System Reset, RESET
- Power LED, form KEYLOCK
- Hard Drive activity LED, IDE LED
- System Speaker, SPEAKER
- Soft-touch button power on/off, SW ON
- External power saving control, EXTSMI (optional)

The connector pin out are described as the figure below:

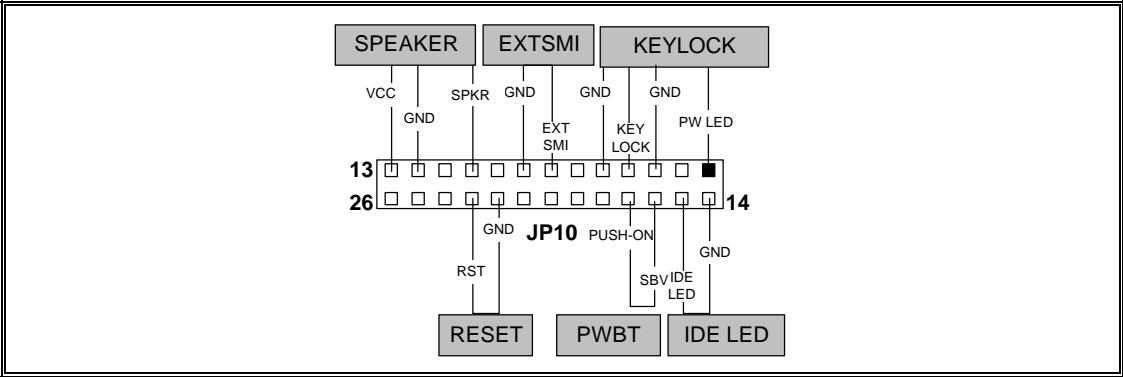

The Onboard Function Connector Pin Out

Integrated Function Connector

The total of two USB device connectors, a PS/2 mouse, and an Infrared devices are all allocated at this connector (JP2).

- Pin1 to Pin5 for USB1 connector
- Pin11 to Pin15 for USB2 connector
- Pin6 to Pin10 for PS/2 connector
- Pin16 to Pin20 InfraRed connector

The connector pin out signal definitions are described as the table below:

Pin	Signal Name	Pin	Signal Name
1 (USB1)	USB +5 Volt	11 (USB2)	USB +5 Volt
2	USB Port 1-	12	USB Port 2-
3	USB Port 1+	13	USB Port 2+
4	Ground	14	Ground
5	No Connect	15	No Connect
6 (PS/2 Mouse)	PS/2 Data	16 (IR)	+5V
7	PS/2 Clock	17	No Connect
8	Ground	18	Infrared Receive
9	No Connect	19	Ground
10	+5V	20	Infrared Transmit

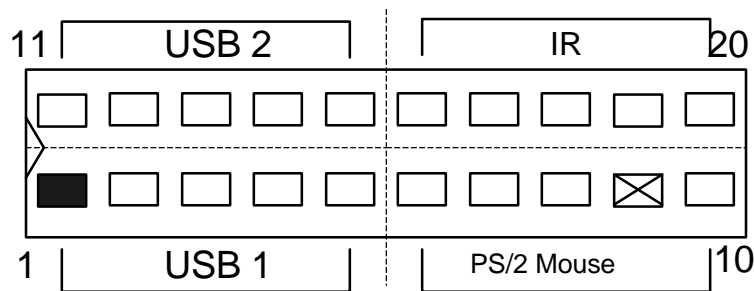

REPLACING BATTERY

A 3V, CR-2030, Lithium battery is installed on the on-board battery socket. This battery is used to supply the CMOS RAM backup power during system powered-off. Danger of explosion if battery is incorrectly replaced. Therefore, if you have any difficulties, please consult to the technical personnel.

QUICK INSTALLATION GUIDE

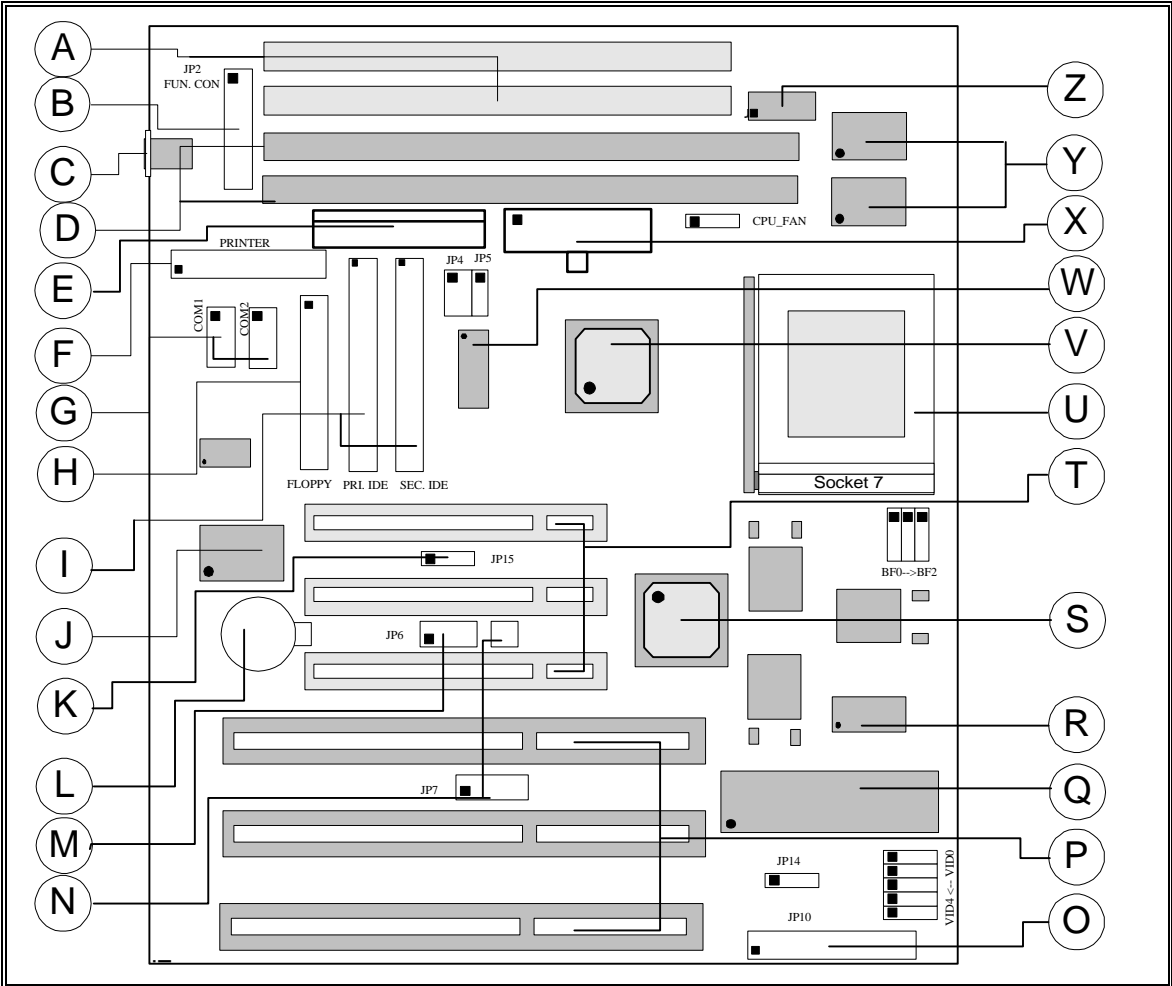

A	SIMM RAM Sockets	N	TB-LINK Creative ISA Header
B	Integrated Functions Connector	O	Front Panel Connector
C	AT Keyboard Connector	P	ISA Bus Connectors
D	3.3v DIMM Sockets	Q	Flash BIOS EEPROM
E	AT Power Supply Connector	R	Voltage Regulator
F	Parallel (Printer) Port Header	S	Intel 82430TX PCiset-PIIX4
G	Serial (COM1 and 2) Port Headers	T	PCI Bus Connectors
H	Floppy Drive Connector	U	Pentium Socket 7
I	IDE Connectors	V	Intel 430TX PCiset System Controller
J	Integrated I/O Controller	W	System Clock Chip
K	WAKEUP-LINK Header	X	ATX Power Supply Connector
L	3V Lithium Battery	Y	256/512K Cache RAM
M	SB-LINK and TB-LINK Creative PCI Header	Z	TAG RAM

“Auto Jumper Yes” Guide

- To enable the “Auto Jumper Yes”, the onboard jumper **JP14** must be shorted (**1-2**). Then, the CPU brand and its core voltage will be automatically detected. But one thing to remember is the CPU speed is necessary to select a suitable one at the CMOS setup. Or, if **JP14** is shorted (**2-3**), that means you should follow the jumper table (at the next page) to set up your CPU settings manually. On the other hand, pressing the key “**F**” to clear the CMOS setting and “**J**” to re-detect the CPU setting during power up your system.

“CPU Voltage Selection”

- The voltage regulator will automatically detect and switch between **Single Power Plane** & **Dual Power Planes**.

INTEL PENTIUM P54C/P55C CPU

Internal CPU Speed (MHz)	External Bus Speed (MHz)	JP4	JP5	Frequency Ratio	BF2	BF1	BF0
90	60	[3-5],[2-4]	[1-2]	1.5x	1-2	1-2	1-2
100	66	[1-3],[2-4]	[1-2]	1.5x	1-2	1-2	1-2
120	60	[3-5],[2-4]	[1-2]	2.0x	1-2	1-2	2-3
133	66	[1-3],[2-4]	[1-2]	2.0x	1-2	1-2	2-3
150	60	[3-5],[2-4]	[1-2]	2.5x	1-2	2-3	2-3
166	66	[1-3],[2-4]	[1-2]	2.5x	1-2	2-3	2-3
200	66	[1-3],[2-4]	[1-2]	3.0x	1-2	2-3	1-2
233	66	[1-3],[2-4]	[1-2]	3.5x	1-2	1-2	1-2

CYRIX/IBM 6x86 M1/M2 CPU

P150+	60	[3-5],[2-4]	[1-2]	2.0x	1-2	1-2	2-3
P166+	66	[1-3],[2-4]	[1-2]	2.0x	1-2	1-2	2-3
PR200	75	[1-3],[4-6]	[1-2]	2.0x	1-2	1-2	2-3
PR233	66	[1-3],[2-4]	[1-2]	3.0x	1-2	2-3	1-2
PR266	66	[1-3],[2-4]	[1-2]	3.5x	1-2	1-2	1-2
PR300	66	[1-3],[2-4]	[1-2]	3.5x	1-2	1-2	1-2

AMD-K5/K6 CPU

PR90	60	[3-5],[2-4]	[1-2]	1.5x	1-2	1-2	1-2
PR100	66	[1-3],[2-4]	[1-2]	1.5x	1-2	1-2	1-2
PR133	66	[1-3],[2-4]	[1-2]	1.5x	1-2	1-2	1-2
PR166/K6-166	66	[1-3],[2-4]	[1-2]	2.5x	1-2	2-3	2-3
PR200	66	[1-3],[2-4]	[1-2]	3.0x	1-2	2-3	1-2
PR233	66	[1-3],[2-4]	[1-2]	3.5x	1-2	1-2	1-2
PR266	66	[1-3],[2-4]	[1-2]	4.0x	2-3	1-2	2-3
PR300	66	[1-3],[2-4]	[1-2]	4.5x	2-3	2-3	2-3

IDT-C6

150	50	[3-5],[4-6]	[2-3]	3.0x	1-2	2-3	1-2
150	75	[1-3],[4-6]	[1-2]	2.0x	1-2	1-2	2-3
180	60	[3-5],[2-4]	[1-2]	3.0x	1-2	2-3	1-2
200	66	[1-3],[2-4]	[1-2]	3.0x	1-2	2-3	1-2
225	75	[1-3],[4-6]	[1-2]	3.0x	1-2	2-3	1-2

CPU Voltage Selection

CPU type	Voltage Requirements
Intel Pentium P54C, Cyrix/IBM M1 6x86, AMD-K5, IDT-C6	3.4V (STD) / 3.5V (VRE)
Intel Pentium P55C, Cyrix/IBM M1 6x86L Cyrix/IBM 6x86M2, K6-PR166/200 AMD-K6-PR233, PR266	2.8V 2.9V 2.2V, 2.9V, 3.2V or 3.3V

CPU Core Voltage Table

Vcore	VID4	VID3	VID2	VID1	VID0
2.2V	1-2	1-2	1-2	2-3	1-2
2.8V	1-2	2-3	1-2	1-2	1-2
2.9V	1-2	2-3	1-2	1-2	2-3
3.2V	1-2	2-3	2-3	1-2	1-2

Bus Frequency Ratio

Ratio	BF2	BF1	BF0
2.0x	1-2	1-2	2-3
2.5x	1-2	2-3	2-3
3.0x	1-2	2-3	1-2
3.5x / 1.5x	1-2	1-2	1-2

3.3V	1-2	2-3	2-3	1-2	2-3
3.4V	1-2	2-3	2-3	2-3	1-2
3.5V	1-2	2-3	2-3	2-3	2-3

4.0x	2-3	1-2	2-3
4.5x	2-3	2-3	2-3
5.0x	2-3	2-3	1-2
5.5x	2-3	1-2	1-2

Quick Reference of Your Motherboard

[A] SIMM Sockets

This motherboard provides two 72-pin SIMM sockets. The minimum memory size is 8 MB by using two 1M x 32 SIMM modules and maximum memory size is 256 MB by four 16M x 32 SIMM modules. Memory timing can be configured through the BIOS setup, please refer to the chapter of BIOS setup. They support both Fast Page Mode and Extended Date Output (EDO).

The two sockets are arranged into two banks, Bank 0 and Bank 1, of two sockets each. Each bank provides a 64/72-bit wide data path. Both SIMMs modules in a bank must be of the same memory size and type. There are no jumper settings required for the memory size or type, which is automatically detected by the system BIOS.



EDO DRAM

Extended Data Out (or Hyper Page) DRAM is designed to improve the DRAM read performance. EDO DRAM holds the memory data valid until the next memory access cycle, unlike standard fast page mode DRAM that tri-states the memory data when the pre-charge cycle occurs, prior to the next memory access cycle.

[B] Integrated Functions Connector

- I) From Pin1 to Pin5 is the first USB device “USB1” and Pin11 to Pin15 is the second USB device “USB2” connector. Universal Serial Bus (USB) is new interface standard for any I/O device “Outside the Box”. USB makes your peripherals have a real plug and play (PnP) capabilities with up to 12MB/sec data speed In the coming soon, any external device connected to your computer will be standardized into USB standard which are all have a special 4-pin rectangle shape connector. Therefore, with the Intel chipset, this motherboard builds two USB headers on-board for you future investment. If you are using an USB device, you must purchase an optional USB connector.
- II) From Pin6-10 is the PS/2 device, likes some PS/2 keyboard and mouse, are all have a standard 6-pin round shape connector. However, it does not have a unique onboard standard. Therefore, please refer to the Chapter “Motherboard Installation”, in order to purchase an suitable PS/2 Mouse Connector.
- III) From Pin16-20 is a 5-pin interface on the front panel I/O connector is provided to allow connection to a Hewlett Packard HSDSL-1000 compatible Infra-red (IrDA) transmitter/receiver. Once the module is connected to the front panel I/O header, Serial port 2 can be re-directed to the IrDA module. When configured for IrDA, the user can transfer files to or from portable devices such as laptops, PDA’s and printers using application software such as LapLink. The IrDA specification provides for data transfers at 115kbps from a distance of 1 meter. Support for Consumer Infra Red (ASK-IR) is also included, please refer to your IR equipment for more detailed information.

[C] AT Keyboard Connector

This connection is used for a standard IBM-compatible keyboard, such as 101 enhanced keyboard.

[D] SDRAM Socket

There have a Unbuffered, 3.3 Volts, SDRAM socket on-board provides more flexibility for your system memory upgrade.

[E] AT Power Supply Connector

Based on the AT specification, one 12-pin power connector covers all the required power sources, $\pm 5V$ and $\pm 12V$.

[F] Parallel (Printer) Port Connector

One Parallel port with SPP, EPP and ECP capabilities.

[G] Serial (COM 1 and 2) Port Headers

This motherboard provides two high-speed UART compatible serial ports.

[H] Floppy Drive Connector

A 34-pin connector on-board allows connection to two 360K, 720K, 1.2M, 1.44, 2.88M floppy disk drives.

[I] IDE Connectors

The fast IDE interface supports up to four IDE devices providing an interface for IDE hard disks and CD-ROMs. Each IDE device can have independent timings. The IDE interface supports PIO IDE transfers up to 14 Mbytes/s and Bus Master IDE transfers up to 33 Mbytes/sec.

[J] Integrated I/O Controller

On the motherboard, keyboard controller, serial ports, parallel port and floppy drive are all integrated into a single chip. The I/O port allows you to configure through the BIOS setup. This integrated I/O chip provides:

- Plug-and-Play compatible.
- Supports two 360K, 720K, 1.2M, 1.44, 2.88M floppy disk drives
- One multi-mode high performance parallel port which can be BIOS configured as standard (SPP) mode, enhanced (EPP) mode, high speed (ECP) mode.
- Supports two 16C550 compatible enhanced serial ports.
- Supports IrDA or ASKIR infra-red interface.

[K] WAKEUP-LINK Interface

This header is used to connect an add-in NIC (Network Interface Card) which has WOL capability to a motherboard.

[L] 3V Lithium Battery

An on-board battery holder is used to hold a 3 Volts CR-2032 Lithium battery which makes the battery's replacement more convenient. This battery is used to supply power for the RTC CMOS RAM in order to save your system setting and date/time counting during system power-off. In general, the battery's life-time is about 5 years. If you see a "BIOS checksum error" message happened while system turn-on, it maybe caused by the battery low. You can try to fix it by simply replaced the battery.

[M] SB-LINK Interface

This header is a Creative SB-LINK™ interface, which makes its debut with the Sound Blaster® AWE64D PCI sound solutions. SB-LINK™ uses Intel's PC-PCI technology found in Intel TX and newer corelogic chipsets.

[N] TB-LINK Interface

This headers interface supporting TOMATO™ SCE8/SCV6 Sound Card using the Creative Audio Chip.

[O] Front Panel Connector

For you convenience, all the front panel functions are integrated into a single connector, which included power LED and keyboard lock, turbo switch, reset switch, SMI switch and speaker.

[P] ISA Add-in Board Connectors

This motherboard provides three 16 bit ISA slots which allows backward hardware compatibility.

[Q] Flash BIOS

The flash BIOS allows user have more flexibility to upgrade their motherboard. The flash BIOS can be programmed by software easily. For the latest BIOS upgrade information, please feel free to visit our web site: <http://www.zida.com>.

[R] Voltage Regulator

The voltage regulator combines switching regulator and low dropout linear regulator in single chip which provides high efficiency voltage sources to the motherboard.

[S] Intel 82430TX PCIset PCI ISA IDE Xecelerator (PIIX4)

The Intel 82371AB is a 324-pin BGA package IC which provides the following features:

- Interface between the PCI local bus and ISA bus.
- Supports for 2 Universal Serial Bus (USB) ports.
- Integrated IDE controller supports two IDE connectors for up to four IDE devices providing an interface for IDE hard disks and CD ROMs. Up to four IDE devices can be supported in Bus Master Mode, it also support for “Ultra 33” synchronous DMA compatible devices.
- Enhanced DMA controller with Fast Type-F DMA
- Two Interrupt Controller based on two 82C59 and Timers based on 82C54 which provides System Timer, Refresh Request, Speaker Tone Output.
- It contains full support for the Advanced Configuration and Power Interface (ACPI) specification.

[T] PCI Add-in Board Connectors

This motherboard provides three 32-bits PCI slots with up to 133MB/sec burst data transfer rate.

[U] Pentium® Type-7 Socket

The type-7 socket is a 321-pin, zero insertion force (ZIF) socket. It provides users with a performance upgrade path to Pentium® OverDrive technology.



PENTIUM® PROCESSOR

An approved Pentium heatsink is necessary for proper thermal dissipation in an AT compliant chassis. The processor/heatsink assembly must be securely fastened to the Socket 7 ZIF socket by two clips. These clips fit over the heatsink assembly and attach to the outer wide tabs of the Socket 7 assembly.

[V] Intel 430TX PCiset System Controller

The Intel 82430TX integrates the cache and main memory DRAM control functions and provides bus control for transfers between the CPU, cache, main memory and the PCI Bus. The TX comes in a 324-pins BGA package.

[W] System Clock Chip

This system clock chip provides all the clock signals for the system, such as CPU clock, PCI bus clock, and etc.

[X] ATX Power Supply Connector

Based on the ATX specification, one 20-pin power connector covers all the required power sources, $\pm 5V$, $\pm 12V$ and $\pm 3.3V$, with soft-touch button power on/off features. This connector reduces the installation time and minimizes the chance of defects caused by incorrect connection.

[Y] 256K/512K Cache RAM

An 256K/512K Cache RAM on-board in order to further enhanced of your system performance.

[Z] TAG RAM

High speed Tag RAM.

Award BIOS and CMOS Setup Utility

GETTING START

All computer motherboards provide a Setup utility program for specifying the system configuration and settings. If your motherboard came in a computer system, the proper configuration entries may have already been made.

This motherboard has been programmed with Award BIOS setup utility. The setup utility program is stored inside the on-board programmable Flash ROM chip. This Setup program allows user to modify the basic system configuration. The system configuration is stored in the battery backup CMOS RAM (inside the real time clock chip) so that it retains the setup information when the power is turned off. This chapter explains the setup utility for the Award BIOS.

ENTERING SETUP

When you turn on the computer, the system allows you an opportunity to enter the BIOS Setup utility. During the POST (**P**ower **O**n **S**elf **T**est), you can see the below message appears at the bottom of the screen, press key or simultaneously press <Ctrl>, <Alt> and <Esc> keys.

```
Press DEL to enter SETUP, ESC to skip memory test
```

If the message disappears before you respond, POST will continue with its test routines, thus preventing you from calling up the Setup utility. However, if you still want to enter Setup, restart the system to try again by turning it OFF and then ON or pressing the "RESET" button on the system case. You may also restart your system by simultaneously pressing <Ctrl>, <Alt> and <Delete> keys. If you do not press the keys at the correct time and the system does not boot up, and error message below may be displayed and you will again be asked to,

```
PRESS F1 TO CONTINUE, CTRL-ALT-DEL TO ENTER SETUP
```

Summary of Control Keys

Up arrow	Move to previous item
Down arrow	Move to next item
Left arrow	Move to the item in the left hand
Right arrow	Move to the item in the right hand
Esc key	Main Menu – Quit and not save changes into CMOS Status Page Setup Menu and Option Page Setup Menu -- Exit current page and return to Main Menu
PgUp key	Increase the numeric value or make changes
PgDn key	Decrease the numeric value or make changes
+ key	Increase the numeric value or make changes
- key	Decrease the numeric value or make changes
F1 key	General help, only for Status Page Setup Menu and Option Page Setup Menu
(Shift)F2 key	Change color from total 16 colors. F2 to select color forward, (Shift) F2 to select color backward
F3 key	Calendar, only for Status Page Setup Menu
F5 key	Restore the previous CMOS value from CMOS, only for Option Page Setup Menu
F6 key	Load the default CMOS value from BIOS default table, only for Option Page Setup Menu
F7 key	Load the setup default, only for Option Page Setup Menu
F10 key	Save all the CMOS changes, only for Main Menu

GETTING HELP

Main Menu

The on-line description of the highlighted setup function is displayed at the bottom of the screen.

Status Page Setup Menu/Option Page Setup Menu

Press F1 to pop up a small help window that describes the appropriate keys to use and the possible selections for the highlighted item. To exit the Help Window, press <Esc>.

THE MAIN MENU

Once you enter Award BIOS CMOS Setup Utility, the Main Menu (Figure 1) will appear on the screen. The Main Menu allows you to select from ten setup functions and two exit choices. Use arrow keys to select among the items and press <Enter> to accept or enter the sub-menu.

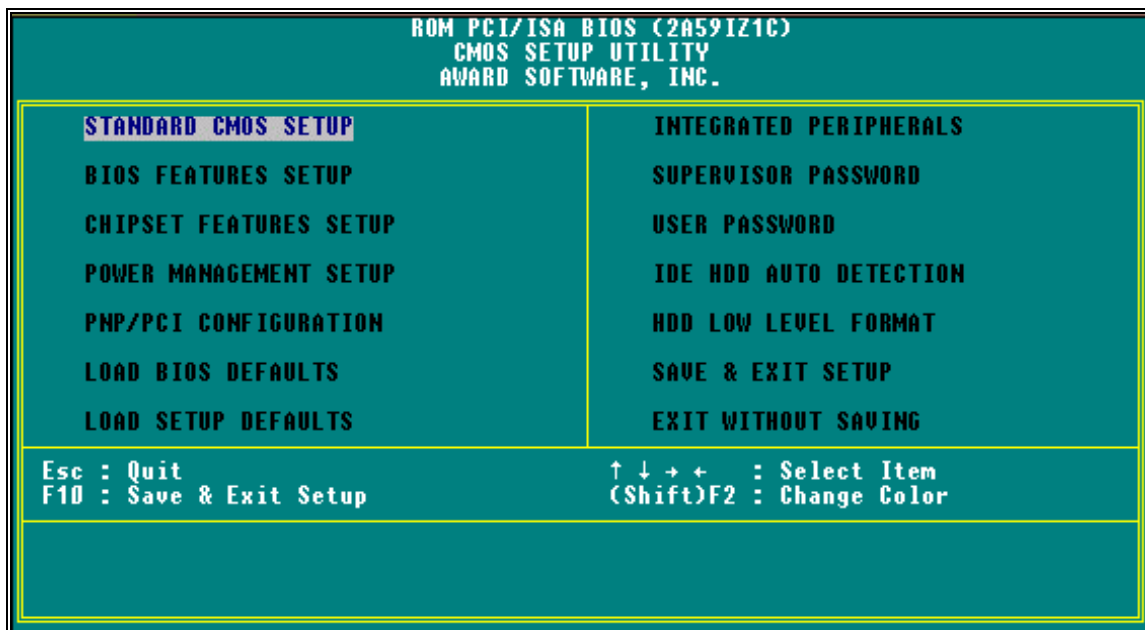

The CMOS Setup Utility Main Menu

Standard CMOS Setup

This setup page includes all the items in a standard compatible BIOS.

BIOS Features Setup

This setup page includes all the items of Award special enhanced features.

Chipset Features Setup

This setup page includes all the items of chipset special features.

Power Management Setup

This setup page includes all the items of green features.

PnP/PCI Configuration

This setup page includes all the items of PnP , PCI IRQ and ISA IRQ settings. You can allocate these resources for your system use in this menu.

Load BIOS Defaults

This function is for user to load the BIOS default settings. The BIOS defaults indicates the most appropriate value of the system parameter which the system would be in minimum performance.

Load SETUP Defaults

This function is for user to load the SETUP default settings. SETUP defaults indicates the values required by the system for the maximum performance.

Integrated Peripherals

This setup page is used to configure the On-board multi I/O and IDE interface.

Supervisor/User Password

This function is for Change, set, or disable the supervisor or user password. The supervisor password allows you to limit the user access to the system and Setup.

IDE HDD Auto Detection

Automatically configure hard disk parameters.

HDD Low Level Format

This Automatically configure hard disk parameters.

Save & Exit Setup

Save CMOS value changes to CMOS and exit setup.

Exit Without Save

Abandon all CMOS value changes and exit setup.

STANDARD CMOS SETUP

The items in Standard CMOS Setup Menu are divided into 10 categories. Each category includes no, one or more than one setup items. Use the arrow keys to highlight the item and then use the <PgUp> or <PgDn> keys to select the value you want in each item.

```

ROM PCI/ISA BIOS (2A59I219)
STANDARD CMOS SETUP
AWARD SOFTWARE, INC.

Date (mm:dd:yy) : Wed, Jan  1 1997
Time (hh:mm:ss) : 12 : 11 : 23

HARD DISKS          TYPE      SIZE    CYLS  HEAD  PRECOMP  LANDZ  SECTOR  MODE
-----
Primary Master     : Auto      0        0    0    0        0    0    0  AUTO
Primary Slave      : Auto      0        0    0    0        0    0    0  AUTO
Secondary Master   : Auto      0        0    0    0        0    0    0  AUTO
Secondary Slave    : Auto      0        0    0    0        0    0    0  AUTO

Drive A : 1.44M, 3.5 in.
Drive B : None

Video  : EGA/VGA
Halt On : All Errors

Base Memory: 0K
Extended Memory: 0K
Other Memory: 512K
-----
Total Memory: 512K

ESC : Quit          ↑ ↓ + - : Select Item      PU/PD/+/- : Modify
F1  : Help          (Shift)F2 : Change Color

```

Date & Time

Enter current Date & Time to set system clock. The date format is <month> <day> <year> and the time format is <hour> <minute> <second>. The time is calculated based on the 24-hour military-time clock.

Primary and Secondary Master / Slave

The categories identify the types of IDE hard disk on primary or secondary IDE channel that have been installed in the computer. There are 46 pre-defined types and a user definable type. Type "1" to Type "46" are predefined. Type "User" is user-definable.

Press PgUp or PgDn to select a numbered hard disk type or type the number and press <Enter>. Note that the specifications of your drive must match with the drive table. The hard disk will not work properly if you enter improper information for this category. If your hard disk drive type is not matched or listed, you can use Type User to define your own drive type manually.

If you select Type "User", related information is asked to be entered to the following items. Enter the information directly from the keyboard and press <Enter>. This information should be provided in the documentation from your hard disk vendor or the system manufacturer.

There are the option of Type "AUTO" and Mode "AUTO" to auto detect the hard disk type and the hard disk mode (Normal, LBA and Large). If a hard disk has not been installed select NONE and press <Enter>.

 **NOTICE FOR HARD DISK LARGER THAN 528MB**

The Mode settings are for IDE hard disks only. There are three entries you can select from in the mode field, "Normal", "Large" and "LBA".

Set Mode to the Normal settings for IDE hard disk drives smaller than 528MB. Use the LBA setting for drives over 528MB that use Logical Block Addressing mode to allow larger IDE hard disks.

Drive A / Drive B

This category identifies the types of floppy disk drive A or drive B that have been installed in the computer.

Video

This category selects the type of adapter used for the primary system monitor that must match your video display card and monitor. Although secondary monitors are supported, you do not have to select the type in Setup.

Halt On

This category determines whether the computer will stop if an error is detected during power up. There are different types of error can be configured in this category.

Total Memory

This category is display-only which is determined by POST (Power On Self Test) of the BIOS.

Base Memory

The POST of the BIOS will determine the amount of base (or conventional) memory installed in the system. The value of the base memory is typically 640K for systems with 640K or more memory installed on the motherboard.

Extended Memory

The BIOS determines how much extended memory is present during the POST. This is the amount of memory located above 1MB in the CPU's memory address map.

Other Memory

This refers to the memory located in the 640K to 1024K address space. This is memory that can be used for different applications. DOS uses this area to load device drivers to keep as much base memory free for application programs. Generally, this area is used for Shadow RAM.

BIOS FEATURES SETUP

The item BIOS Features Setup Menu is divided into 23 categories. Each category includes no, one or more than one setup items. Use the arrow keys to highlight the item and then use the <PgUp> or <PgDn> keys to select the value you want in each item.

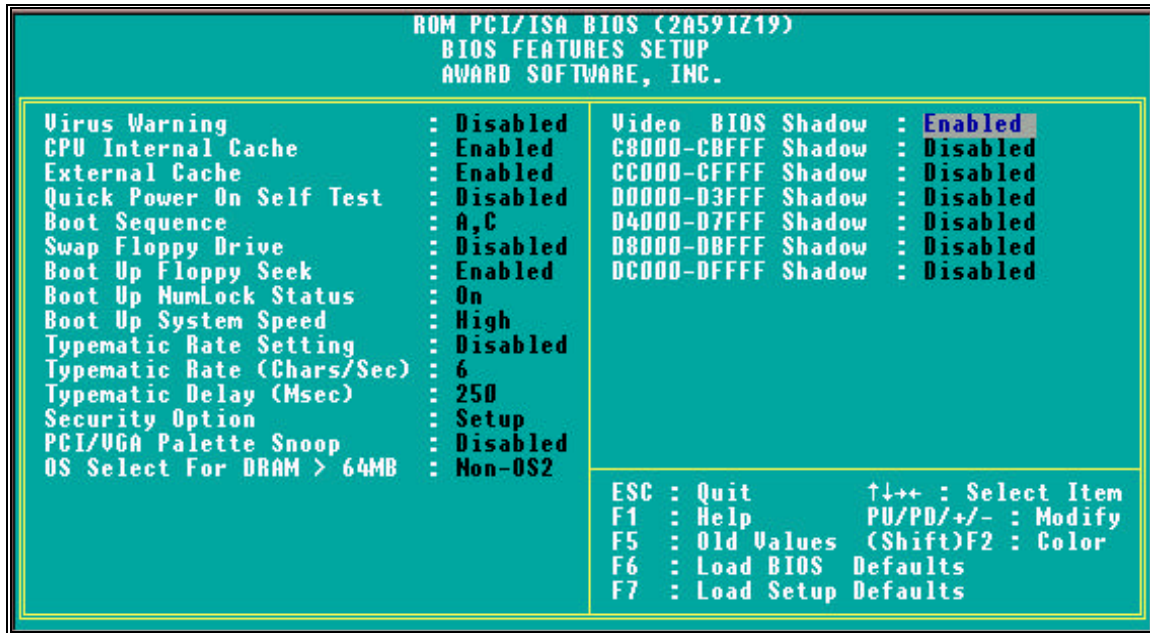

The Default Setting of BIOS Features Setup

Virus Warning

You can “Enable” or “Disable” this feature. When enabled, it will activate automatically if anything attempt to access the boot sector or hard disk partition table during system boot-up. The default value is “Disabled”.

CPU Internal Cache

This category enables or disables the internal cache to speed up memory access. The default value is “Enabled”.

External Cache

This category enables or disables the secondary (L2) cache to speed up memory access. The default value is “Enabled”.

Quick Power On Self Test

This category speeds up Power On Self Test (POST) after you power on the computer. If it is set to “Enabled”, BIOS will shorten or skip some check items during POST. The default value is “Disabled”.

Boot Sequence

This category determines which drive computer searches first for the disk operating system (i.e., DOS). The default setting is “A,C”, means that the system will determine the drive A before drive C.

Swap Floppy Drive

This feature allows you to enable the system swap floppy function, the default is “Disabled”. When this function enables, the system will assign the Drive A as Drive B, and vice versa.

Boot Up Floppy Seek

The default setting is “Enabled”, so that the BIOS will search for floppy disk drive to determine if it is 40 or 80 tracks. If disabled, BIOS will not search for the type of floppy disk drive by track number. Note that there will be no warning message if the drive installed is 360K.

Boot Up NumLock Status

It determine the Num-Lock is turned on/off Num Lock. when the system is powered on so that the end user can use the arrow keys on both the numeric keypad and the keyboard. The default value is “On”.

Boot Up System Speed

It selects the default system speed - the speed that the system will run at immediately after power up. The default value is “High”.

Gate A20 Option

The A20 signal option specify A20 controlled by keyboard controller or chipset hardware. The default is “Fast”, therefore, the A20 signal is controlled by chipset specific method.

Typematic Rate Setting

Typematic Rate sets the rate at which characters on the screen at which characters on the screen repeat. The default setting is Disabled.

Typematic Rate (Chars/Sec)

Typematic rate sets the rate at which characters on the screen repeat when a key is pressed and held down. You can select 6-30 characters per second. The default setting is “6”.

Typematic Delay (M sec)

When holding down a key, the time between the first and second character display. you specified numbers of times of character repeat on the screen. The default setting is “250”.

Security Option

This category allows you to limit access to the system and Setup or just to Setup. When you select system, the system will not boot and access to Setup will be denied if the correct password is not entered at the prompt. If you select Setup, the system will boot but access to Setup will be denied if the correct password is not entered at the prompt. The default setting is “Setup”.

PCI/VGA Palette Snoop

This option controls the system to access the PCI VGA card palette register. In general, this option is “Disabled”. However, you may need to enable this option for some VGA cards which have incorrect color displayed on some software application.

OS Select For DRAM > 64MB

Some the OS/2 application access the memory in different mode. Enable this option to allow the system use another mode to access the main memory for OS/2 applications.

VIDEO BIOS Shadow

The system BIOS is automatically shadowed. The default setting for the “Video BIOS Shadow” is “Enabled”. It determines whether video BIOS will be copied to RAM. However, it is optional from chipset design. Video Shadow will increase the video speed.

C8000 - CFFFF Shadow/E8000 - EFFFF Shadow

These categories determine whether optional ROM will be copied to RAM by 16K byte. You can enable the optional shadow or you can disable it. The default setting is disabled.

CHIPSET FEATURES SETUP

This section allows you to configure the system based on the specific features of the installed chipset. This chipset manages bus speeds and access to system memory resources, such as DRAM and the external cache.

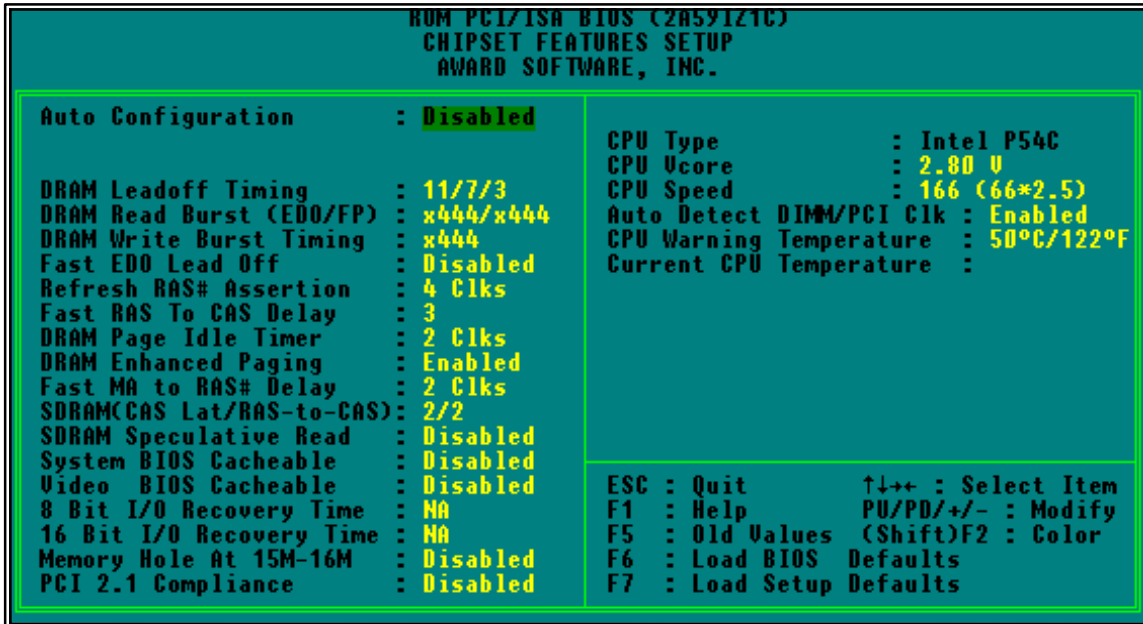

The Default Setting of Chipset Features Setup

Auto Configuration

The “Auto Configuration” default is “Enabled”. This automatically setting up your system at optimum performance. You cannot change the setting with the Auto Configuration enabled. You are not recommended to change the setting unless you know what are the functions of the item.

CPU Type, CPU Vcore, CPU Speed.

Able to set the CPU Speed manually, but for the CPU type and the CPU Voltage will automatically detected by BIOS if you set the “Auto Jumper Yes” enabled. If you faced an unpredictable case that make your system cannot start, press “J” during power up to override and set up your system again.

POWER MANAGEMENT SETUP

Power Management setup controls the system board Power Management features. This is a feature of microprocessor with the energy-efficient technology. The setup screen is shown in figure below.

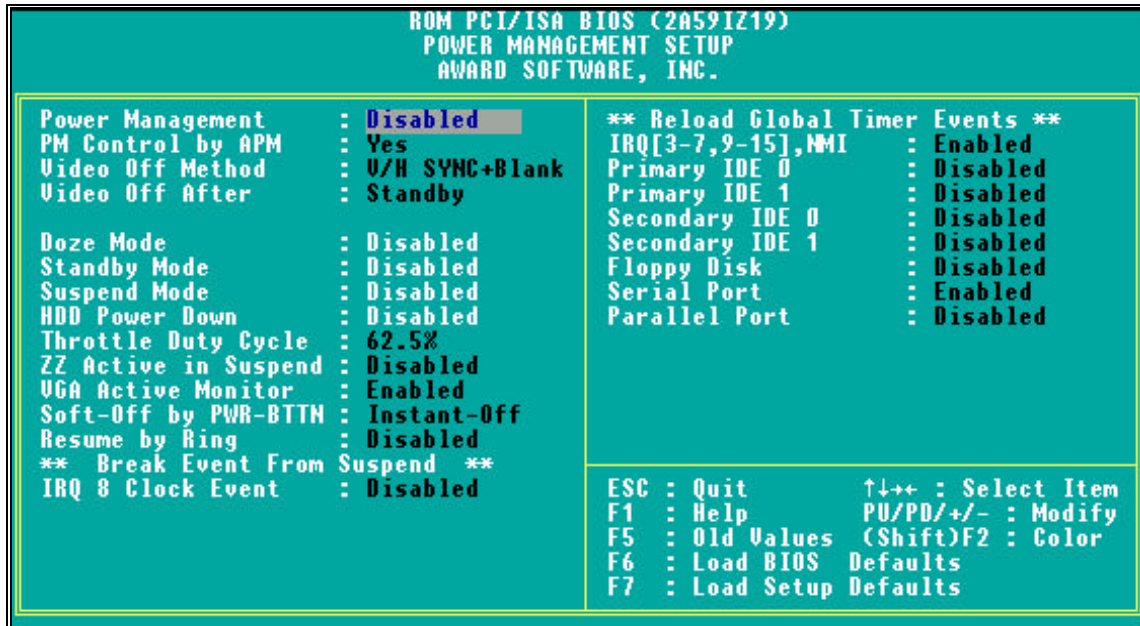

The Default Setting of Power Management Setup

Power Management

“Power Management” is the master control for the power saving features, including HDD power down, Doze, Standby and suspend Modes and the I/O Device Timer, that together form the hard-ware power conservation scheme. There are three options:

- User Defined - Allows you to configure the power conservation features by yourself.
- Max Saving - Factory default setting for optimal power saving setting
- Min Saving - Factory default setting for minimal power saving setting
- Disable - Turn off all the power conservation features.

PM Control by APM

This feature is automatically set to “Yes”, the system BIOS will wait for APM prompt before it enters the GREEN mode.

! NOTICE

If APM is installed, & if there is a task running, event the timer is time out, the APM will not prompt the BIOS to put the system into any power saving mode!

Video Off Method

There are three options you can choose to turn off the VGA display.

- Blank Screen — The system will blank the screen only.
- DPMS — This function is enabled for only the VGA card supporting DPM.
- V/H SYNC + Blank — Choose this mode if your system use the monitor with power management feature. In addition to the blank screen, the system will turn off the horizontal and vertical sync signal. Most monitor will turn off itself if these signal are inactive.

The default setting is “V/H SYNC+Blank”.

Video Off After

As the system moves from lesser to greater power-saving modes, select the mode in which you want the monitor to blank.

Doze Mode

After the selected period of system inactivity (1 minute to 1 hour), the CPU clock runs at slower speed while all other devices still operate at full speed.

Standby Mode

After the selected period of system inactivity (1 minute to 1 hour), the fixed disk drive and the video shut off while all other devices still operate at full speed.

Suspend Mode

After the selected period of system inactivity (1 minute to 1 hour), all devices except the CPU shut off.

HDD Power Down

After the selected period of drive inactivity (1 to 15 minutes), the hard disk powers down while all other devices remain active.

Throttle Duty Cycle

When the system enters Doze mode, the CPU clock runs only part of the time. You may select the percent of time that the clock runs.

ZZ Active in Suspend

When enabled, the ZZ signal is active during Suspend mode.

VGA Active Monitor

When enabled, any video activity restarts the global timer for Standby mode.

Soft-Off by PWR-BTTN

This option allow user to select either instant-off or Delay 4 seconds to turn the system to the Suspend mode.

IRQ8 Clock Event

You can turn On or Off monitoring of IRQ8 so it does not awaken the system from Suspend mode.

Reload Global Timer Events

When Enables, an event occurring on each device listed below restarts the global time for Standby mode.

- IRQ3-7, 9-15, NMI
- Primary IDE 0 and 1
- Secondary IDE 0 and 1
- Floppy Disk
- Serial Port
- Parallel Port

PNP/PCI CONFIGURATION

The System BIOS on a PCI platform plays the role of a System Resources Manager. Its main job is to dynamically allocate system resources such as I/O, Memory & IRQs to all PCI devices without any conflicts!

```

ROM PCI/ISA BIOS (2A59I219)
PNP/PCI CONFIGURATION
AWARD SOFTWARE, INC.

PNP OS Installed      : No
Resources Controlled By : Auto
Reset Configuration Data : Disabled

PCI IDE IRQ Map To  : PCI-AUTO
Primary IDE INT#    : A
Secondary IDE INT#  : A

ESC : Quit      | |←→ : Select Item
F1  : Help      | PU/PD/+/- : Modify
F5  : Old Values (Shift)F2 : Color
F6  : Load BIOS Defaults
F7  : Load Setup Defaults

```

The Default Setting of PnP/PCI Configuration

PNP OS Installed

Select Yes if the system operating environment is Plug-and-Play award (e.g., Windows95).

Resources Controlled By

You can allocate the system resources manually by choosing manual. If choose AUTO in this option, the system resources will be allocated automatically.

Reset Configuration Data

Select enabled in this option if you want to reset your PnP hardware information which stored in the system board. For normal use, this option should be set to disabled.

IRQ-3 to 15, DMA-0 to 7

If you select manual in the Resources Controlled by option, you need to assign the system resources manually. In the resources list, you can assign the resources either for PCI / ISA PnP or for legacy (non-PnP) ISA. If you are using a legacy ISA card and using a specified IRQ or DMA, you should assign your

system resources correctly for that ISA card otherwise you system / peripheral card will not function correctly.

PCI IRQ Activated By

Leave the IRQ trigger set at Level unless the PCI device assigned to the interrupt specifies Edge-triggered interrupts.

PCI IDE IRQ Map to

This field lets user select PCI IDE IRQ mapping or PC AT (ISA) interrupts. If your system does not have one or two PCI IDE connectors on the system board, select values according to the type of IDE interface(s) installed in your system (PCI or ISA). Standard ISA interrupts for IDE channels are IRQ14 for primary and IRQ15 for secondary.

Primary/Secondary IDE INT#

Because the PCI IDE interface in the chipset has two channels, it requires two interrupt services. The primary and secondary IDE INT# fields default to values appropriate for two PCI IDE channels, with the primary PCI IDE channel having a lower interrupt than the secondary.

Used Mem base addr

Select a base address for the memory area used by any peripheral that requires high memory.

Used Mem Length

Select a length for the memory area specified the previous field. This field does not appear if no base address is specified..

INTEGRATED PERIPHERALS SETUP

The Integrated Peripherals Setup Menu is divided into different categories. Use the arrow keys to highlight the item and then use the <PgUp> or <PgDn> keys to select the value you want in each item.

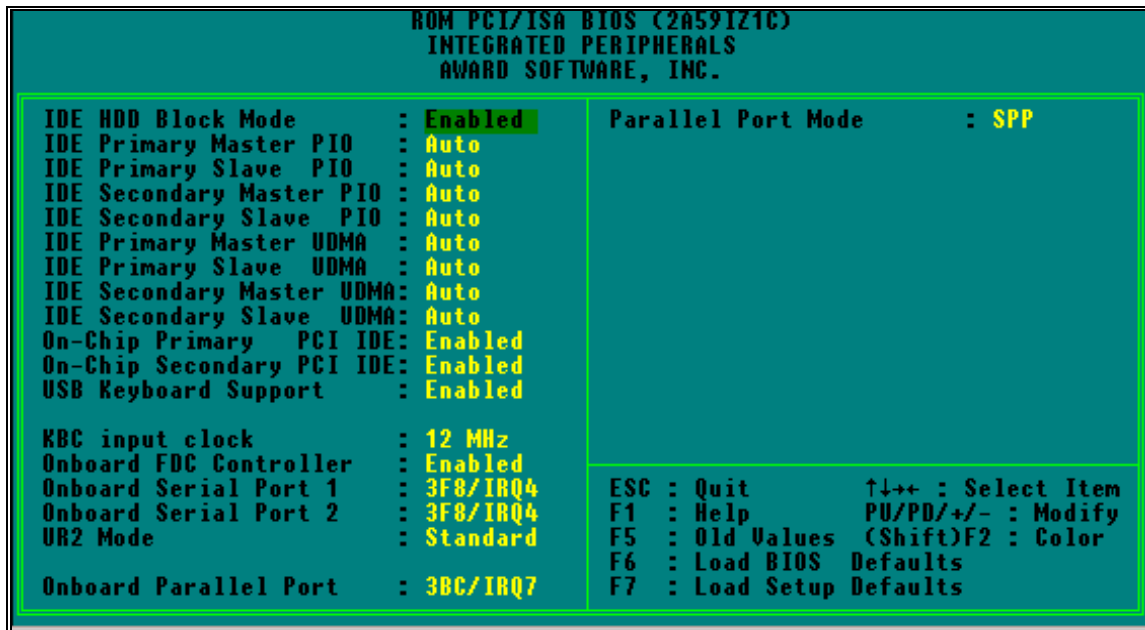

The Default Setting of Integrated Peripherals

IDE HDD Block Mode

If IDE HDD Block Mode Enabled, the BIOS will detect the block size of the HDD and send block command automatically. Select Disable if your hard disk not support the Block mode transfer. The default setting is "Enabled".

IDE Primary/Secondary and Master/Slave PIO Mode

This option sets the PIO mode for all drives connected to the onboard PCI IDE. If this option is set to AUTO, the PIO mode will be set according to the value the drive reports with the auto detect hard disk function. The user may decrease the PIO mode by modifying this option, default is "AUTO".

IDE Primary/Secondary and Master/Slave UDMA

Ultra DMA/33 implementation is possible only if your IDE hard drive supports it and the operation environment includes a DMA driver (Windows95 OSR2 or a third-party IDE bus master driver). If your hard drive and your system software both support Ultra DMA/33, select Auto to enable BIOS support.

On-Chip Primary/Secondary PCI IDE

This option allows you to disable the IDE interface if you are not using it or you are using another peripheral as IDE interface, such as SCSI controller. The default setting is "Enabled".

KBC Input Clock

This option sets the operating frequency for the Keyboard Controller. Four operating frequencies are available: 6MHz, 8MHz, 12MHz and 16MHz.

Onboard FDC Controller

The on-board floppy disk controller can be enabled or disabled by this option..

Onboard Serial Port 1 / Port 2

You can configure the on-board serial port as COM1-COM4 or select “none” to disable the serial port.

Onboard Parallel Port

The on-board parallel port can be configured as LPT1 (378), LPT2 (278) or select “none” to disable the parallel port.

Parallel Port Mode

You can select SPP (Standard mode), EPP(Enhanced mode) and ECP(Extended mode) for parallel port mode in this menu. This communication mode is hardware dependent, please refer to your hardware manual for the Mode setting.

LOAD BIOS DEFAULTS

This features stay in the default system values before the user has changed any CMOS values. If CMOS setting is lost. the BIOS defaults will automatically be loaded.

LOAD SETUP DEFAULTS

This features load the default setting for normal use.

PASSWORD SETTING

When you select the supervisor or user password function, the following message will appear on the screen to assist you in creating a password.

ENTER PASSWORD :

Type the password, up to eight characters, and press <Enter>. The password typed now will clear any previously entered password from CMOS memory. You will be asked to confirm the password. Type the password again and press <Enter>. You may also press <Esc> to abort the selection and not to enter a password.

To disable password, just press <Enter> when you are prompted to enter password. A message will confirm the password being disabled. Once the password is disabled, the system will boot and you can enter Setup freely.

PASSWORD DISABLED .

If you select System at Security Option of BIOS Features Setup Menu, you will be prompted for the password every time the system is rebooted or any time you try to enter Setup. If you select Setup at Security Option of BIOS Features Setup Menu, you will be prompted only when you try to enter Setup.

IDE HDD AUTO DETECTION

You can use this utility to detect the IDE hard disk parameters. It can automatically detect up to four hard disk.

SAVE AND EXIT SETUP

Select this option when you finished setup the CMOS and it will save the change you made and reboot the system after you press "YES".

EXIT WITHOUT SAVING

If you decided not to save any change you had made, you can select this option to exit the CMOS setup and all the change you made will be ignored.

Motherboard Technical Specification

ENVIRONMENT

Parameter	Specification
Operating Temperature Humidity Atmosphere	+0°C to +55°C 20% to 80% Non-condensing
Non-operating/Transportation Temperature Humidity Atmosphere	-20°C to +65°C 10% to 90% Non-condensing
AT Power Supply Requirement	
±5 V	±5 %
±12 V	±5 %
ATX Power Supply Requirement	
+3.3 V	±5 %
±5 V	±5 %
±12 V	±5 %
Vibration Operating	0.2G Z axis (up and down), 5 to 300 Hz 0.1G X axis (front and rear), 5 to 300 Hz Y axis (left and right), 5 to 300 Hz

DIMENSIONS AND WEIGHT

Dimension Approx.	234 x 220 mm (9.23x8.66 inches)
Net Weight	0.475 Kg (1.08 lb.)

ELECTRICAL SPECIFICATION

Onboard Voltage Regulation	Under 3.3V condition
Voltage transient	± 5%
Set point variation	± 1%
Onboard Current Limitation	
Under 3.3V condition	about 14 Ampere (max.)

POWER CONSUMPTION

The is designed to operate with a 200 W ATX power supply. For a system configured with the motherboard including a 200 MHz Pentium processor w/ 512 KB Cache, 64 MB EDO DRAM, 3.5-inch floppy drive, 2.1 GB IDE hard drive, 8X IDE CD-ROM, and a PCI graphics card, The overall calculated power dissipation is about 80W. However, this information is provided only as reference for the total system power usage.

Request For Technical Support

In order to provide you with effective and quick technical support, we need to know your system specification and environments. Please fill the following form as complete as possible so we can give you assistance.

PRODUCT INFORMATION	
MODEL	
CHIPSET MODEL	
RAM TYPE/SIZE/BRAND/SPEED	
BIOS VERSION	
PURCHASE DATE	
PROBLEM DESCRIPTION	
OPERATING SYSTEM	
APPLICATION SOFTWARE	
PROBLEM DESCRIPTION	

SYSTEM CONFIGURATION		
Display Card (Brand/Model)		
Resolution		
IDE Controller Card (Brand/Model)		
LAN Card (Brand/Model)		
Fax/Modem Card (Brand/Model)		
SCSI Controller (Brand/Model)		
Multi I/O Card (Brand/Model)		
Other Add-on Card (Brand/Model)		
IDE Disk Drive	PRIMARY MASTER (Brand/Model)	
	PRIMARY SLAVE (Brand/Model)	
	SECONDARY MASTER (Brand/Model)	
Floppy Drive	SECONDARY SLAVE (Brand/Model)	
	DRIVE A (Brand/Model)	
	DRIVE B (Brand/Model)	
Other Device (Brand/Model)		