

# EP-LX370Y

**ISA/PCI AGP Mainboard with Onboard  
PCI IDE and Super Multi-I/O**

**TRADEMARK**

All products and company names are trademarks or registered trademarks of their respective holders.  
*These specifications are subject to change without notice.*

*Manual Revision 1.0  
November 30, 1998*

## Technical Support Services

If you need additional information, help during installation or normal use of this product, please contact your retailer. If your retailer can not help, you may E-Mail us with any questions at the following address [tech@epox.com](mailto:tech@epox.com)

Record your serial number before installing your EP-LX370Y mainboard. (the serial number is located near the ISA slots at the edge of the board)

***EPoX EP-LX370Y serial number:***

-----

## BIOS Upgrades

Please use either our Web Site or BBS for current BIOS Upgrades.

### **Internet Access**

<http://www.epox.com>

<http://www.epox.com.tw>

[sales@epox.com](mailto:sales@epox.com)

[tech@epox.com](mailto:tech@epox.com)

### **Modem Access**

886-2-2247-2742 (Taiwan)

31-182-618451 (The Netherlands)

You can access this number via a Hayes-compatible modem with a 2,400 to 28,800 baud rate. The following setup format is required:

8 Data Bits, No Parity, 1 Stop Bit.

If your modem is unable to connect at higher baud rates, try connecting at 2,400 baud before contacting Technical Support.

***Thank you for using EPoX mainboards!***

## User Notice

---

No part of this product, including the product and software may be reproduced, transmitted, transcribed, stored in a retrieval system, or translated into any language in any form by any means without the express written permission of EPoX Computer Company (here in after referred to as EPoX) except documentation kept by the purchaser for backup purposes.

EPoX provides this manual “as is” without warranty of any kind, either express or implied, including but not limited to the implied warranties or conditions of merchantability or fitness for a particular purpose. In no event shall EPoX be liable for any loss or profits, loss of business, loss of use or data, interruption of business or for indirect, special incidental, or consequential damages of any kind, even if EPoX has been advised of the possibility of such damages arising from any defect or error in the manual or product. EPoX may review this manual from time to time without notice. For updated BIOS, drivers, or product release information you may visit EPoX’s home page at: <http://www.epox.com>

Products mentioned in this manual are mentioned for identification purposes only. Product names appearing in this manual may or may not be registered trademarks or copyrights of their respective companies.



**The product name and revision number are both printed on the mainboard itself.**

### Handling Procedures

**Static electricity can severely damage your equipment.** Handle the EP-LX370Y and any other device in your system with care and avoid unnecessary contact with system components on the mainboard.

Always work on an antistatic surface to avoid possible damage to the motherboard from static discharge.

We assume no responsibility for any damage to the EP-LX370Y mainboard that results from failure to follow installation instructions or failure to observe safety precautions.

	<b>CAUTION</b>	
<b>The EP-LX370Y mainboard is subject to damage by static electricity. Always observe the handling procedures.</b>		

---

## Table of Contents

---

<b>Section 1</b>	<b>Introduction</b>	
	Components Checklist .....	1-1
	<b>Overview</b>	
	EP-LX370Y Form-factor .....	1-2
	I/O Shield Connector .....	1-3
	Power-On/Off (Remote) .....	1-3
	System Block Diagram .....	1-4
<b>Section 2</b>	<b>Features</b>	
	EP-LX370Y Features .....	2-1
<b>Section 3</b>	<b>Installation</b>	
	EP-LX370Y Detailed Layout .....	3-1
	<b>Easy Installation Procedure</b>	
	Configure DIP Switch .....	3-2
	System Memory Configuration .....	3-3
	Device Connectors .....	3-7
<b>Section 4</b>	<b>Award BIOS Setup</b>	
	BIOS Instructions .....	4-1
	Standard CMOS Setup .....	4-2
	BIOS Features Setup .....	4-3
	Chipset Features Setup .....	4-8
	Power Management Setup .....	4-13
	PNP/PCI Configuration .....	4-16
	Load Setup Defaults .....	4-18
	Integrated Peripherals .....	4-19
	Change Supervisor or User Password .....	4-23
	IDE HDD Auto Detection .....	4-24
	HDD Low Level Format .....	4-26

---

Save & Exit Setup ..... 4-26  
Exit Without Saving ..... 4-26

***Section 5***      ***Appendix***

***Appendix A***

Memory Map ..... A-1  
I/O Map ..... A-1  
Timer & DMA Channels Map ..... A-2  
Interrupt Map ..... A-2  
RTC & CMOS RAM Map ..... A-3

***Appendix B***

POST Codes ..... A-4  
Unexpected Errors ..... A-7

***Appendix C***

Load Setup Defaults ..... A-8

---



**Section 1**  
**INTRODUCTION**

**Components Checklist**

- ✓ A. (1) EP-LX370Y mainboard
- ✓ B. (1) EP-LX370Y user's manual
- ✓ C. (1) Floppy ribbon cable
- ✓ D. (1) Hard drive ribbon cables
- ✓ E. (1) Driver and utility

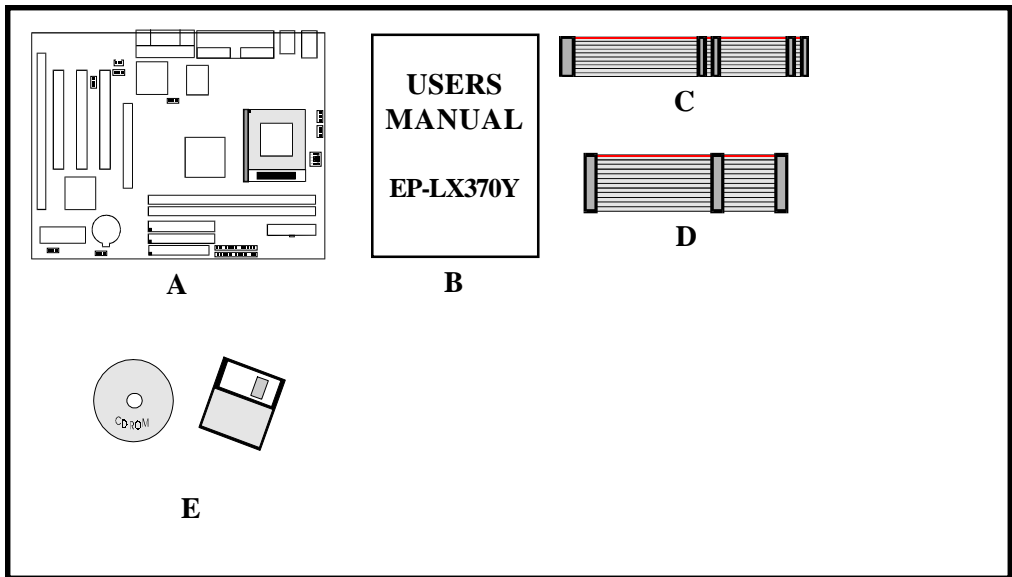

## EP-LX370Y Form-Factor

The EP-LX370Y is designed with MicroATX form factor - the new industry standard of chassis. The MicroATX form factor is essentially a Baby-AT baseboard rotated 90 degrees within the chassis enclosure and a new mounting configuration for the power supply. With these changes the processor is relocated away from the expansion slots, allowing them all to hold full length add-in cards. MicroATX defines a double height aperture to the rear of the chassis which can be used to host a wide range of onboard I/O. Only the size and position of this aperture is defined, allowing PC manufacturers to add new I/O features (e.g.; TV input, TV output, joystick, modem, LAN, etc.) to systems. This will help systems integrators differentiate their products in the marketplace, and better meet your needs.

- Smaller size promotes a smaller system size.
- I/O shield does not need to be retooled in an ATX 2.01 or later. Mainboard could be used in an ATX 2.01-compliant.
- A smaller power supply can be used. High integration on mainboard reduces the system costs.

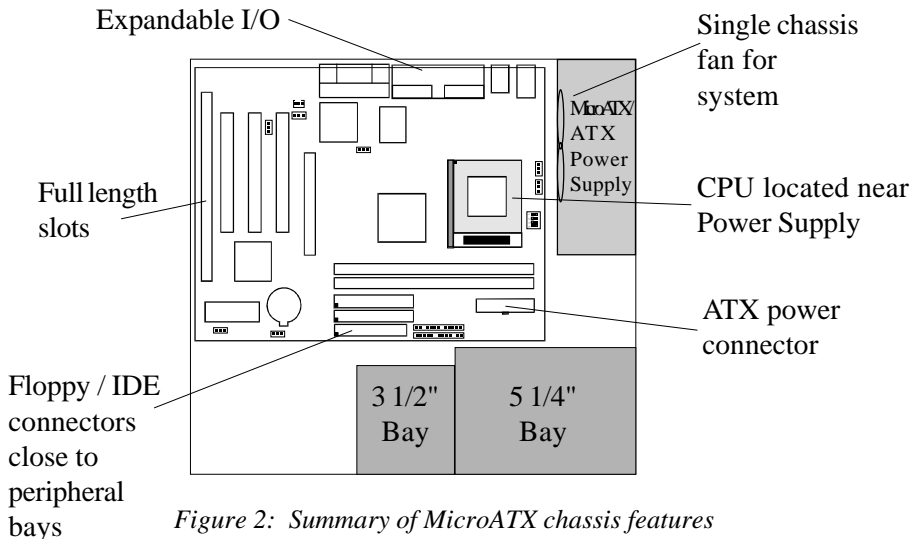

Figure 2: Summary of MicroATX chassis features



## I/O Shield Connector

The EP-LX370Y is equipped with an I/O back panel. Please use the appropriate I/O shield (figure 3).

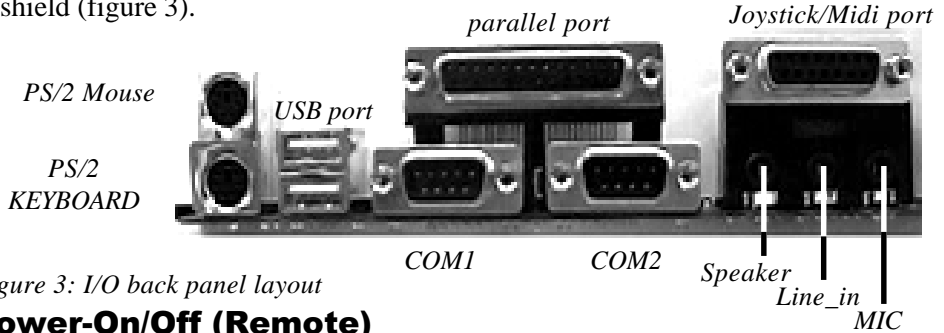

Figure 3: I/O back panel layout

## Power-On/Off (Remote)

The EP-LX370Y has a single 20-pin connector for ATX power supplies. For ATX power supplies that support the **Remote On/Off** feature, this should be connected to the systems front panel for system Power On/Off button. The systems power On/Off button should be a momentary button that is normally open.

The EP-LX370Y has been designed with "Soft Off" functions. You can turn Off the system from one of two sources: The first is the front panel Power On/Off button, and the other is the "Soft Off" function (coming from the EP-LX370Y's onboard circuit controller) that can be controlled by the operating system. Windows 95 will control this when the user clicks that they are ready to Shutdown the system.

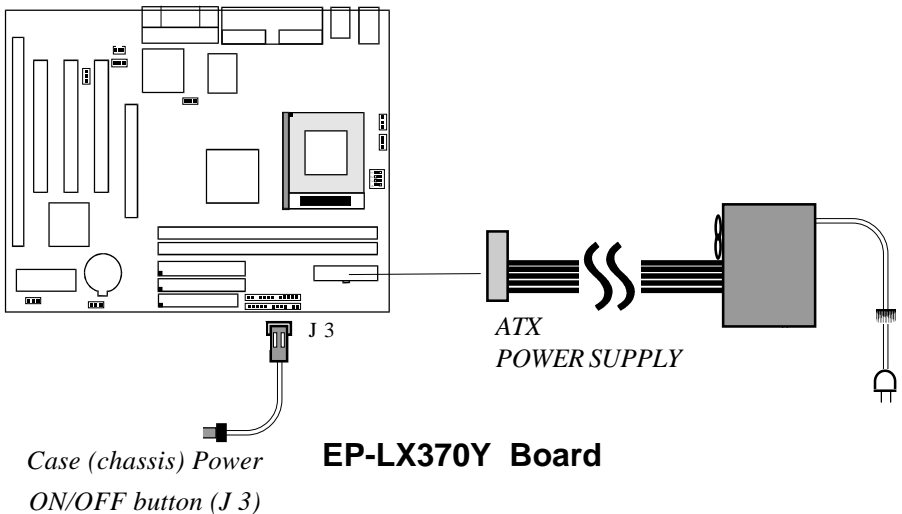

Figure 4: Simple ATX Power ON/OFF Controller

# System Block Diagram

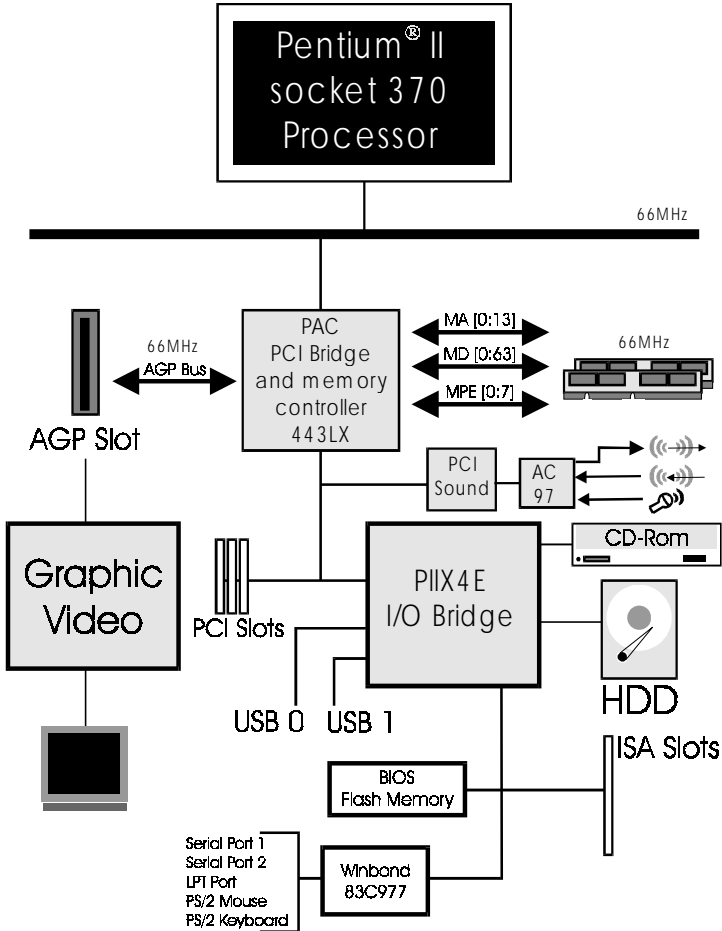

Figure 5: System Block Diagram

---

## Section 2

# FEATURES

---

### EP-LX370Y Features:

---

- EP-LX370Y is based on the Mendocino Processor operating at 300 ~ 433MHz on PGA370. The board is configured by an DIP Switch to match your CPU clock speed.
- Designed with Intel's 82443 LX (or 82443 EX) AGPset.
- Supports up to 512MB of DRAM (minimum of 8 MB) on board (please see Section 3-2).
- Supports (1) 16 bit ISA slots, (3) 32 bit PCI slots, (1) AGP slot and provides (2) independent high performance PCI IDE interfaces capable of supporting PIO Mode 3/4 and Ultra DMA 33 devices. The EP-LX370Y supports (3) PCI Bus Master slots and a jumperless PCI INT# control scheme which reduces configuration confusion when plugging in PCI card(s).
- Supports ATAPI (e.g. CD-ROM) devices on both Primary and Secondary IDE interfaces.
- Designed with Winbond W83977TF Multi I/O: (1) floppy port, (1) parallel port (EPP, ECP), and (2) serial ports (16550 Fast UART).  
Note: Japanese "Floppy 3 mode" is also supported
- Features Award Plug & Play BIOS. With Flash Memory you can always upgrade to the current BIOS as they are released. (<http://www.epox.com/> please visit our Technical Support section for the latest updates)
- EP-LX370Y utilizes a Lithium battery which provides environmental protection and longer battery life.
- Supports the Universal Serial Bus (USB) Connector. The onboard PIIX4/PIIX4E chip provides the means for connecting PC peripherals such as; keyboards, joysticks, telephones, and modems.
- Built-in ATX 20-pin power supply connector.
- Software power-down when using Windows® 95.

- Supports ring-in feature (remote power-on through external modem, allows system to be turned on remotely).
- Resume by Alarm - Allows your system to turn on at a preselected time.
- Power Loss Recovery - In the event of a power outage your system will automatically turn itself back on without user intervention.
- Supports CPU Hardware sleep and SMM (System Management Mode).
- Built-in WOL (Wake-up On Lan) Connector.

---

**Section 3**  
**INSTALLATION**

---

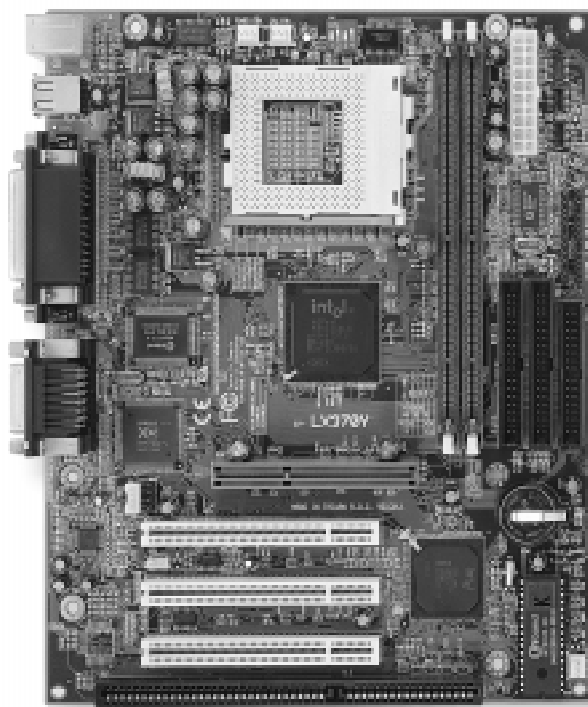

**EP-LX370Y Detailed Layout**

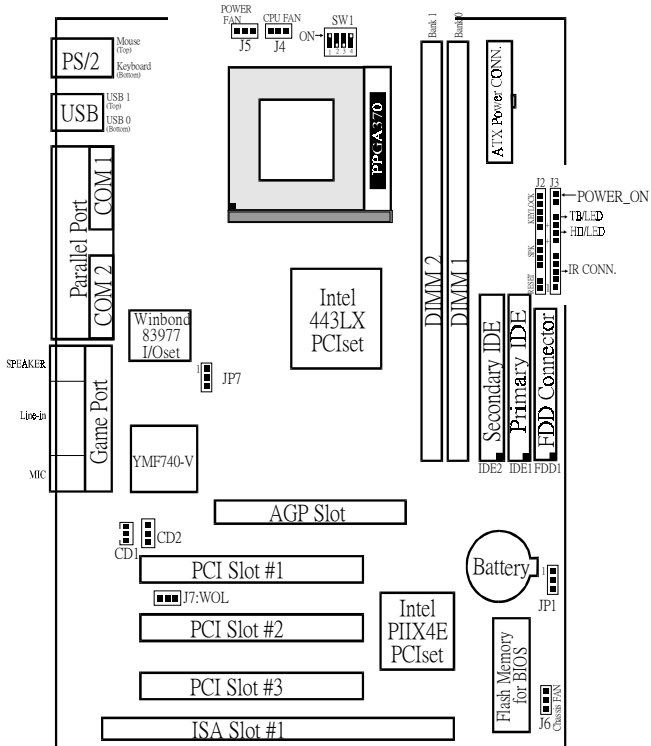

Figure 1

# Easy Installation Procedure

## Easy Installation Procedure

The following must be completed before powering on your new system:

- 3-1. **Configure DIP Switch and Jumper to match your hardware**
- 3-2. **Install memory chips**
- 3-3. **Device Connectors**

### Section 3-1 Configure DIP Switch

We design this motherboard with a DIP Switch to make your install fast and easy.

The following will describe all of the DIP Switch that you are required to set before moving on to step 3-2.

*Note: The DIP Switch as depicted as shown (Figure 1) in their correct physical orientation.*

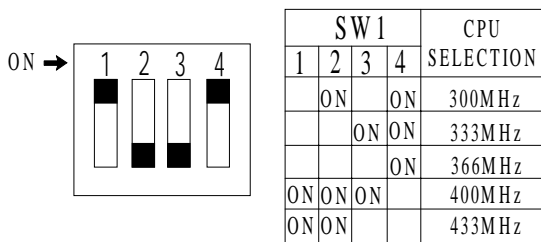

**JP1** 1 **Clear COMS**  
 1-2 : Run Mode(default)  
 3 2-3 : Clear CMOS

**JP7** 1 **ON BOARD PCI SOUND**  
 1-2 : Enabled  
 3 2-3 : Disabled

## Section 3-2 System Memory Configuration

### Memory Layout

The EP-LX370Y supports (2) 168-pin DIMMs (Dual In-line Memory Module). The DIMMs can be either EDO (Enhanced Data Out) or SDRAM (Synchronized DRAM).

- DIMM SDRAM may be 83MHz (12ns), 100MHz (10ns) or 125MHz (8ns) bus speed.
- If you use both 50ns and 60ns memory you must configure your BIOS to read 60ns.
- When using Synchronous DRAM we recommend using the 4 clock variety over the 2 clock.
- **Fast Page Mode DRAM (FPM) is not supported by the LX (or EX) AGPset. Only EDO and SDRAM are supported.**

Figure 2 and Table 1 show several possible memory configurations using both SIMM and DIMM.

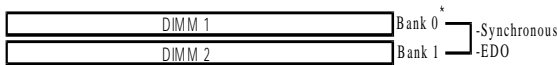

Total Memory	DIMM 1 (Bank 0)	DIMM 2 (Bank 1)
= 512MB Maximum	EDO/SDRAM* 8MB, 16MB, 32MB, 64MB, 128MB, 256MB X 1	EDO/SDRAM* 8MB, 16MB, 32MB, 64MB, 128MB, 256MB X 1
= 256MB Maximum	EDO/SDRAM* 8MB, 16MB, 32MB, 64MB, 128MB, 256MB X 1	None

\* SDRAM only supports 8, 16, 32, 64, 128, 256MB DIMM modules.

Table 1



### DIMM Module Installation

Figure 5 displays the notch marks and what they should look like on your DIMM memory module.

DIMMs have 168-pins and two notches that will match with the onboard DIMM socket. DIMM modules are installed by placing the chip firmly into the socket at a 90 degree angle and pressing straight down (figure 6) until it fits tightly into the DIMM socket (figure 7).

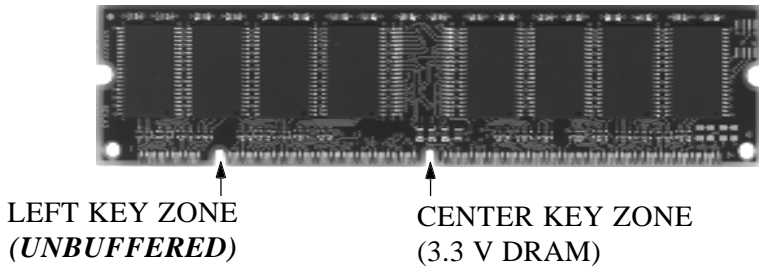

Figure 5

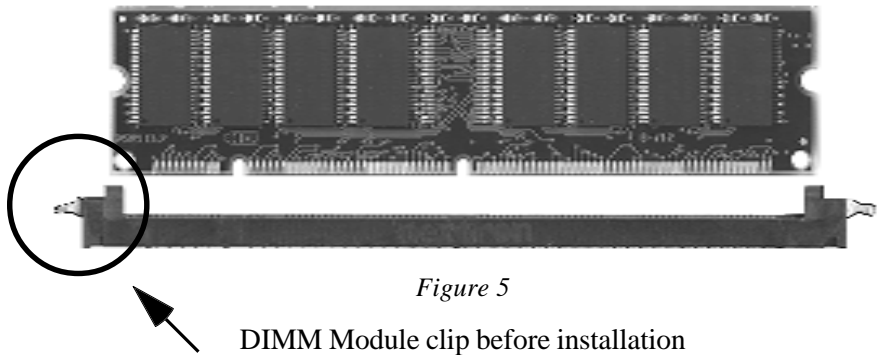
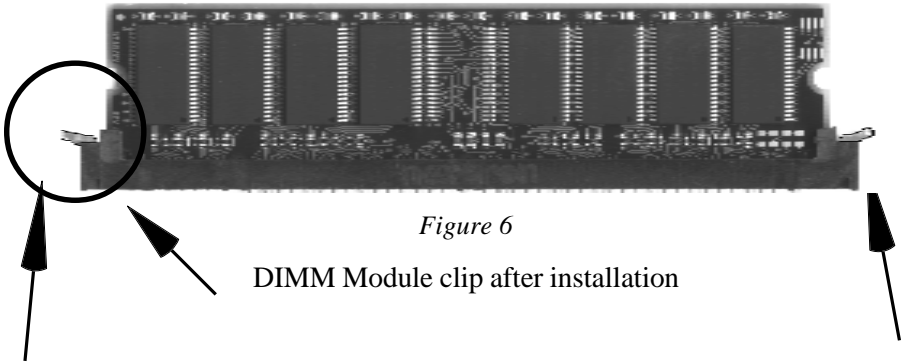

Figure 5

DIMM Module clip before installation



*Figure 6*

DIMM Module clip after installation

To remove the DIMM module simply press down both of the white clips on either side and the module will be released from the socket.

## Section 3-3 Device Connectors

Please install the motherboard into the chassis.

Now that your motherboard is installed you are ready to connect all your connections (figure 7).

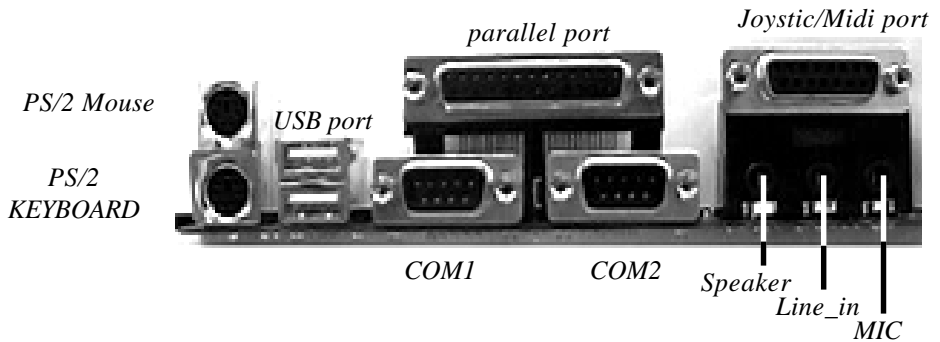
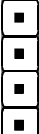

Figure 7

- J2:** Chassis Panel Connector
  - Keylock, Speaker, Reset
- J3:** Turbo LED, HDD LED, IR Conn., Sleep/Power\_ON
- J4:** CPU Fan Power
  - A plug-in for the CPU Fan Power
- J5:** Power Supply Fan
  - A plug-in for the Power supply Fan Power.
- J6:** Chassis Fan Power
  - A plug-in for the chassis Fan Power
- J7:** WOL Connector
- IDE1:** Primary IDE
- IDE2:** Secondary IDE
- FDD1:** Floppy Controller Connector
- PW1:** ATX Power Connector
  - 20-pin power connector

## Section 3-4

### Device Connectors (continued)

**J2** 1  **KeyLock** - Keyboard lock switch & Power LED connector

1. Power LED(+)	4. Keylock
2. N/C	5. GND
3. GND	

1  **Speaker** - Connect to the system's speaker for beeping

1. Speaker	3. GND
2. N/C	4. GND

 **Reset** - Closed to restart system.

**J3** 1  **IR Connector**

1. VCC	4. GND
2. NC	5. IRTX
3. IRRX	

+  **IDE LED indicator** - LED ON when Onboard PCI IDE Hard disks is activate

+  **Turbo LED indicator** - LED ON when higher speed is selected

 **Power On/Off** - This is connected to the power button on the case. Using the Soft-Off by Pwr-BTTN feature, you can choose either Instant Off (turns system off immediatly), or 4 sec delay (you need to hold the button down for 4 seconds before the system turns off). When the system is in 4 sec delay mode, we has added a special feature to make the system go into suspend mode when the button is pressed momentarily.

# Section 4

## AWARD BIOS SETUP

### BIOS Instructions

Award's ROM BIOS provides a built-in Setup program which allows user to modify the basic system configuration and hardware parameters. The modified data will be stored in a battery-backed CMOS, so that data will be retained even when the power is turned off. In general, the information saved in the CMOS RAM will stay unchanged unless there is a configuration change in the system, such as hard drive replacement or a device is added.

It is possible for the CMOS battery to fail, this will cause data loss in the CMOS only. If this does happen you will need to reconfigure your BIOS settings.

#### To enter the Setup Program :

Power on the computer and press the <Del> key immediately, this will bring you into the BIOS CMOS SETUP UTILITY.

ROM PCI / ISA BIOS (2A69JPAC)  
 CMOS SETUP UTILITY  
 AWARD SOFTWARE, INC.

STANDARD CMOS SETUP BIOS FEATURES SETUP CHIPSET FEATURES SETUP POWER MANAGEMENT SETUP PNP/PCI CONFIGURATION INTEGRATED PERIPHERALS LOAD SETUP DEFAULTS	SUPERVISOR PASSWORD USER PASSWORD IDE HDD AUTO DETECTION HDD LOW LEVEL FORMAT SAVE & EXIT SETUP EXIT WITHOUT SAVING
ESC : QUIT F10 : Save & Exit Setup	↑ ↓ → ← : SELECT ITEM (Shift)F2 : Change Color
Time, Date, Hard Disk Type...	

*Figure 1: CMOS Setup Utility*

The menu displays all the major selection items. Select the item you need to reconfigure. The selection is made by moving the cursor (press any direction key ) to the item and pressing the 'Enter' key. An on-line help message is displayed at the bottom of the screen as the cursor is moved to various items which provides a better understanding of each function. When a selection is made, the menu of the selected item will appear so that the user can modify associated configuration parameters.

### 4-1 Standard CMOS Setup

Choose "Standard CMOS Setup" in the CMOS SETUP UTILITY Menu (Figure 2). The Standard CMOS Setup allows the user to configure system settings such as the current date and time, type of hard disk drive installed, floppy drive type, and display type. Memory size is auto-detected by the BIOS and displayed for your reference. When a field is highlighted (use direction keys to move the cursor and the <Enter> key to select), the entries in the field can be changed by pressing the <PgDn> or the <PgUp> key.

ROM PCI/ISA BIOS(2A69JPAC)  
 STANDARD CMOS SETUP  
 AWARD SOFTWARE, INC.

Date (mm:dd:yy) : Wed, Apr 17 1996																								
Time (hh:mm:ss) : 14 : 30 : 50																								
HARD DISKS	TYPE	SIZE	CYLS	HEAD	PRECOMP	LANDZONE	SECTORS	MODE																
Primary Master	: <b>Auto</b>	0	0	0	0	0	0	<b>Auto</b>																
Primary Slave	: <b>Auto</b>	0	0	0	0	0	0	<b>Auto</b>																
Secondary Master	: <b>Auto</b>	0	0	0	0	0	0	<b>Auto</b>																
Secondary Slave	: <b>Auto</b>	0	0	0	0	0	0	<b>Auto</b>																
Drive A : 1.44M, 3.5 in.					<table border="1"> <tr> <td>Base Memory</td> <td>:</td> <td>640K</td> </tr> <tr> <td>Extended Memory</td> <td>:</td> <td>64512K</td> </tr> <tr> <td>Other Memory</td> <td>:</td> <td>384K</td> </tr> <tr> <td colspan="3"><hr/></td> </tr> <tr> <td>Total Memory</td> <td>:</td> <td>65536K</td> </tr> </table>					Base Memory	:	640K	Extended Memory	:	64512K	Other Memory	:	384K	<hr/>			Total Memory	:	65536K
Base Memory	:	640K																						
Extended Memory	:	64512K																						
Other Memory	:	384K																						
<hr/>																								
Total Memory	:	65536K																						
Drive B : None																								
Floppy 3 Mode Support : Disabled																								
Video : EGA/VGA																								
Halt On : All Errors																								
ESC : Quit			↑ ↓ → ← : Select Item			PU/PD/+/- : Modify																		
F1 : Help			(Shift) F2 : Change Color																					

Figure 2: Standard CMOS Setup

**NOTE:** If the hard disk Primary Master/Slave and Secondary Master/Slave are set to Auto, then the hard disk size and model will be auto-detected.

**NOTE:** The “Halt On:” field is used to determine when to halt the system by the BIOS if an error occurs.

**NOTE:** Floppy 3 Mode support is a mode used to support a special 3.5” drive used in Japan. This is a 3.5” disk that stores only 1.2 MB, the default setting for this is disabled.

## 4-2 BIOS Features Setup

Selecting the “BIOS FEATURES SETUP” option in the CMOS SETUP UTILITY menu allows users to change system related parameters in the displayed menu. This menu shows all of the manufacturer’s default values for the EP-LX370Y.

Pressing the [F1] key will display a help message for the selected item.

ROM PCI/ISA BIOS(2A69JPAC)  
 BIOS FEATURES SETUP  
 AWARD SOFTWARE, INC.

Virus Warning	: Disabled	Video BIOS	Shadow	: Enabled
CPU Internal Cache	: Enabled	C8000-CBFFF	Shadow	: Disabled
External Cache	: Enabled	CC000-CFFFF	Shadow	: Disabled
CPU L2 Cache ECC Checking	: Disabled	D0000-D3FFF	Shadow	: Disabled
Quick Power On Self Test	: Enabled	D4000-D7FFF	Shadow	: Disabled
Boot Sequence	: A, C, SCSI	D8000-DBFFF	Shadow	: Disabled
Swap Floppy Drive	: Disabled	DC000-DFFFF	Shadow	: Disabled
Boot Up Floppy Seek	: Enabled			
Boot Up NumLock Status	: On			
Gate A20 option	: Fast			
Typeomatic Rate Setting	: Disabled			
Typeomatic Rate (Chars/Sec)	: 6			
Type matic Delay (Msec)	: 250			
Security Option	: Setup			
PCI/VGA Palette Snoop	: Disabled	Esc : Quit		↑ ↓ → ← : Select Item
Assign IRQ For VGA	: Enabled	F1 : Help		PU/PD/+/- : Modify
OS Select For DRAM > 64MB	: Non-OS2	F5 : Old Values		(Shift) F2 : Color
Report NO FDD For Win 95	: NO	F7 : Load Setup Defaults		

Figure 3: BIOS Features Setup

**Virus Warning:** During and after the system boots up, any attempt to write to the boot sector or partition table of the hard disk drive will halt the system and an error message will appear. You should then run an anti-virus program to locate the virus. Keep in mind that this feature protects only the boot sector, not the entire hard drive. The default value is Disabled.

**Enabled:** *Activates automatically when the system boots up causing a warning message to appear when anything attempts to access the boot sector.*

**Disabled:** *No warning message will appear when anything attempts to access the boot sector.*

**Note:** *Many disk diagnostic programs that access the boot sector table can trigger the virus warning message. If you plan to run such a program, we recommend that you first disable the virus warning.*

**CPU Internal Cache:** This controls the status of the processor's internal cache area.

The default is Enabled.

**Enabled:** *This activates the processor's internal cache thereby increasing performance.*

**Disabled:** *This deactivates the processor's internal cache thereby lowering performance.*

**External (L2) Cache:** This controls the status of the external (L2) cache area.

The default is Disabled.

**Enabled:** *This activates the motherboard's L2 cache thereby increasing performance.*

**Disabled:** *This deactivates the motherboard's L2 cache thereby lowering performance.*

**Quick Power On Self Test:** This category speeds up the Power On Self Test (POST).

The default is Enabled.

**Enabled:** *This setting will shorten or skip of the items checked during POST.*

**Disabled:** *Normal POST.*

**Boot Sequence:** This category determines which drive is searched first by the O/S (Operating System).

The default is A,C,SCSI.

*The following is your list of options:*

*[A, C, SCSI] - [C, A, SCSI] - [C, CD-ROM, A] - [CD-ROM, C, A]*

*[D, A, CD-ROM], [E, A, CD-ROM] - [F, A, CD-ROM] - [SCSI, A, C]*

*[SCSI C, A] - [C Only]*



**Swap Floppy Drive:** This will swap your physical drive letters A & B if you are using two floppy disks.

The default is Disabled.

*Enabled:* Floppy A & B will be swapped under the O/S.

*Disabled:* Floppy A & B will be not swapped.

**Boot Up Floppy Seek:** During Power-On-Self-Test (POST), BIOS will determine if the floppy disk drive installed is 40 or 80 tracks. Only 360K type is 40 tracks while 760K, 1.2MB and 1.44MB are all 80 tracks.

The default is Enabled.

*Enabled:* The BIOS will search the floppy disk drive to determine if it is 40 or 80 tracks.

*Disabled:* The BIOS will not search for the type of floppy disk drive by track number.

**NOTE:** BIOS can not tell the difference between 720K, 1.2MB and 1.44MB drive types as they are all 80 tracks.

**Boot Up NumLock Status:** This controls the state of the NumLock key when the system boots.

The default is On.

*On:* The keypad acts as a 10-key pad.

*Off:* The keypad acts like the cursor keys.

**Gate A20 Option:** This refers to the way the system addresses memory above 1MB (extended memory).

The default is Fast.

*Normal:* The A20 signal is controlled by the keyboard controller or chipset hardware.

*Fast:* The A20 signal is controlled by Port 92 or chipset specific method.

**Typematic Rate Setting:** This determines the keystrokes repeat rate.

The default is Disabled.

*Enabled:* Allows typematic rate and typematic delay programming.

*Disabled:* The typematic rate and typematic delay will be controlled by the keyboard controller in your system.

**Typematic Rate (Chars/Sec):** This is the number of characters that will be repeated by a keyboard press.

The default is 6.

*6: 6 characters per second. 8: 8 characters per second.  
10: 10 characters per second. 12: 12 characters per second.  
15: 15 characters per second. 20: 20 characters per second.  
24: 24 characters per second. 30: 30 characters per second.*

**Typematic Delay (msec):** This setting controls the time between the first and the second character displayed by typematic auto-repeat.

The default is 250.

*250: 250 msec.  
500: 500 msec.  
750: 750 msec.  
1000: 1000 msec.*

**Security Option:** This category allows you to limit access to the System and Setup, or just to Setup.

The default is Setup.

*System: The system will not boot and the access to Setup will be denied if the correct password is not entered at the prompt.*

*Setup: The system will boot; but the access to Setup will be denied if the incorrect password is not entered at the prompt.*

**PCI/VGA Palette Snoop:** This field controls the ability of a primary PCI VGA controller to share a common palette (When a snoop write cycles) with an ISA video card.

The default is Disabled.

*Enabled: If an ISA card is connected to a PCI VGA card via the VESA connector, and that ISA card connects to a VGA monitor, then that ISA card uses the RAMDAC of the PCI card.*

*Disabled: Disables the VGA card Palette Snoop function.*

**OS Select For DRAM > 64MB:** Some operating systems require special handling. Use this option only if your system has greater than 64MB of memory.

The default is Non-OS2.

*OS2: Select this if you are running the OS/2 operating system with greater than 64MB of RAM.*

*Non-OS2: Select this for all other operating systems and configurations.*

**Video BIOS Shadow:** This option allows video BIOS to be copied into RAM. Video Shadowing will increase the video performance of your system. The default is Enabled.

*Enabled: Video shadow is enabled.*

*Disabled: Video shadow is disabled.*

**C8000 - CBFFF Shadow:**

**CC000 - CFFFF Shadow:**

**D0000 - D3FFF Shadow:**

**D4000 - D7FFF Shadow:**

**D8000 - DBFFF Shadow:**

**DC000 - DFFFF Shadow:**

These categories determine whether ROMs from option cards will be copied into RAM. This will be in 16K byte or 32K byte units, and the size will depend on chipset of the option card.

*Enabled: Optional shadow is enabled.*

*Disabled: Optional shadow is disabled.*

### 4-3 Chipset Features Setup

Choose the “CHIPSET FEATURES SETUP” in the CMOS SETUP UTILITY menu to display following menu.

ROM PCI/ISA BIOS(2A59IPAB)  
 CHIPSET FEATURES SETUP  
 AWARD SOFTWARE, INC.

Auto Configuration	: Enabled	SDRAM CAS latency Time	: 3
DRAM Speed selection	: 60ns	Auto Detect DIMM/PCI Clk	: Enabled
MA Wait State	: Slow	Spread Spectrum	: 0.5% (CNTR)
EDO RAS# To CAS# Delay	: 3	CPU Host Clock	: Default
EDO RAS# Precharge Time	: 3		
EDO DRAM Read Burst	: x333		
EDO DRAM Write burst	: x222		
DRAM Data Integrity Mode	: Non-ECC		
CPU-To-PCI IDE Posting	: Enabled		
System BIOS Cacheable	: Disabled		
Video BIOS Cacheable	: Enabled		
Video RAM Cacheable	: Disabled		
8 Bit I/O Recovery Time	: 1		
16 Bit I/O Recovery Time	: 1		
Memory Hole At 15M-16M	: Disabled		
Passive Release	: Enabled		
Delayed Transaction	: Disabled	Esc : Quit	↑ ↓ → ← : Select Item
AGP Aperture Size (MB)	: 64	F1 : Help	PU/PD/+/- : Modify
SDRAM RAS-to-CAS Delay	: Fast	F5 : Old Values	(Shift) F2 : Color
SDRAM RAS Precharge Time	: Fast	F7 : Load Setup Defaults	

Figure 4: Chipset Features Setup

**Auto Configuration:** This selects predetermined optimal values of the chipset parameters.

The default is Enabled.

*Enabled:* This enables auto-configuration and provides the option to select predefined timing modes.

*Disabled:* This allows the user to specify DRAM timing parameters.

**Note:** If you exceed the performance characteristics of memory in your system it will result in lockups, crashes and other problematic system operations.

**EDO DRAM Speed Selection:** This value must correspond to the speed of the DRAM installed in your system.

The default is 60ns.

*50ns: (Faster) Burst Wait State, for 50ns EDO DRAM.*

*60ns: (Slower) Burst Wait State, for 60ns Fast Page Mode/EDO DRAM.*

**MA Additional Wait State:** This allows the option to insert an additional wait state before the beginning of a memory read. Use of this option may be required to achieve compatibility with some system configurations.

The default is Slow.

*Fast: Inserts no wait state.*

*Slow: Inserts one wait state for the memory cycle.*

**EDO RAS# to CAS# Delay:** Allows you to insert a timing delay between the CAS and RAS strobe signals, used when DRAM is written to, read from, or refreshed.

The default is 3.

*2: Faster performance.*

*3: Better reliability.*

**EDO RAS# Precharge Time:** The precharge time is the number of cycles it takes for the RAS to accumulate its charge before EDO DRAM refresh. If insufficient time is allowed, refresh may be incomplete and the EDO DRAM may fail to retain data.

The default is 3.

*3: Time equals 3 host clocks.*

*4: Time equals 4 host clocks.*

**EDO DRAM Read Burst (B/E/F):** This setting will allow you to set the timing for burst mode reads from EDO DRAM. The lower the timing number the faster the system addresses the memory.

The default is x333.

*x222: Use of this option may cause conflicts with some system configurations.*

*x333: This is used for standard system configurations.*

**EDO DRAM Write Burst (B/E/F):** This setting will allow you to set the timing for burst mode writes to EDO DRAM. The lower the timing number the faster the system addresses the memory.

The default is x222.

*x222: Use of this option may cause conflicts with some system configurations.*

*x333: This is used for standard system configurations.*

**DRAM Data Integrity Mode:** Use this option to configure the type of DRAM in your system.

The default is Non-ECC.

*Non-ECC: If your memory is Non-ECC memory, choose this option.*

*ECC: If your memory is ECC memory, choose this option.*

**CPU-To-PCI IDE Posting:** This option allows the computer to post write cycles from the CPU to the PCI IDE interface. IDE accesses are posted in the CPU to PCI buffers, for cycle optimization.

The default is Enabled.

*Enabled: Enabled*

*Disabled: Disabled*

**System BIOS Cacheable:** This allows you to copy your BIOS code from slow ROM to fast RAM.

The default is Disabled.

*Enabled: The option will improve system performance. However, if any program writes to this memory area, a system error may result.*

*Disabled: System BIOS non-cacheable.*

**Video BIOS Cacheable:** This option copies the video ROM BIOS to fast RAM (C0000h to C7FFFh).

The default is Enabled.

*Enabled: Enables the Video BIOS Cacheable to speed up the VGA Performance.*

*Disabled: Will not use the Video BIOS Cacheable function.*

**Video RAM Cacheable:** This option allows the CPU to cache read/writes of the video RAM.

The default is Disabled.

*Enabled: This option allows for faster video access.*

*Disabled: Reduced video performance.*

**8 Bit I/O Recovery Time:** This function allows you to set the wait state that is added to an 8 bit ISA instruction originated by the PCI bus.

The default is .

*NA: No wait state*                    *8: 8 wait states*  
*1: 1 wait states*                    *2: 2 wait states*  
*3: 3 wait states*                    *4: 4 wait states*  
*5: 5 wait states*                    *6: 6 wait states*  
*7: 7 wait states*

**16 Bit I/O Recovery Time:** This function allows you to set the wait state that is added to an 16 bit ISA instruction originated by the PCI bus.  
The default is 1.

*NA: No wait state*                    *4: 4 wait states*  
*3: 3 wait states*                    *2: 2 wait states*  
*1: 1 wait states*

**Memory Hole at 15M-16M:** You can reserve this memory area for the use of ISA adaptor ROMs.  
The default is Disabled.

*Enabled: This field enables the main memory (15~16MB) to remap to ISA BUS.*

*Disabled: Normal Setting.*

**NOTE: If this feature is enabled you will not be able to cache this memory segment.**

**Passive Release:** This option allows access from the CPU to PCI bus to be active during passive release. Otherwise, the arbiter only accepts another PCI master access to local DRAM.  
The default is Enabled.

*Enabled: Enabled*  
*Disabled: Disabled*

**Delayed Transaction:** This option allows the chipset to use its embedded 32-bit posted write buffer to support delay transactions cycles.  
The default is Disabled.

*Enabled: Select enabled to support PCI 2.1 specification.*  
*Disabled: Disabled.*

**AGP Aperture Size:** The amount of system memory that the AGP card is allowed to share.  
The default is 64.

- 4: 4MB of systems memory accessible by the AGP card.*
- 8: 8MB of systems memory accessible by the AGP card.*
- 16: 16MB of systems memory accessible by the AGP card.*
- 32: 32MB of systems memory accessible by the AGP card.*
- 64: 64MB of systems memory accessible by the AGP card.*
- 128: 128MB of systems memory accessible by the AGP card.*
- 256: 256MB of systems memory accessible by the AGP card.*

**SDRAM RAS# to CAS# Delay:** Allows you to insert a timing delay between the CAS and RAS strobe signals, used when SDRAM is written to, read from, or refreshed.

The default is Fast.

*Fast: Provides faster memory performance.*

*Slow: Provides better memory compatibility.*

**SDRAM Precharge Time:** The precharge time is the number of cycles it takes for the RAS to accumulate its charge before SDRAM refresh. If insufficient time is allowed, refresh may be incomplete and the SDRAM may fail to retain data.

The default is Fast.

*Fast: Provides faster memory performance.*

*Slow: Provides better memory compatibility.*

**SDRAM CAS Latency Time:** This setting defines the CALT timing parameter of the SDRAM in terms of clocks.

The default is 3.

*2: Provides faster memory performance.*

*3: Provides better memory compatibility.*

**CPU Warning Temperature:** This is the temperature that the computer will respond to an overheating CPU.

The default is Enabled.

*Enabled: Temperature is monitored on the CPU*

*Disabled: This feature is turned off.*

**Current CPU Temperature:** This is the current temperature of the CPU.

**Current Power FAN Speed:** The current power fan speed in RPMs.

**Current CPU FAN Speed:** The current CPU fan speed in RPMs.



**Current Chassis FAN Speed:** The current chassis fan speed in RPMs.

**CPU(V):** The voltage level of the CPU.

**Note:** The hardware informaton above is not available for a mainboard without NS LM75/LM78 ICs.

### 4-4 Power Management Setup

Choose the “POWER MANAGEMENT SETUP” in the CMOS SETUP UTILITY to display the following screen. This menu allows the user to modify the power management parameters and IRQ signals. In general, these parameters should not be changed unless it’s absolutely necessary.

ROM PCI/ISA BIOS (2A59IPAB)  
 POWER MANAGEMENT SETUP  
 AWARD SOFTWARE, INC.

ACPI Function	: Enabled	** Reload Global Timer Events **	
Power Management	: User Define	IRQ [3-7, 9-15], NMI	: Enabled
PM Control by APM	: Yes	Primary IDE 0	: Disabled
Video off Method	: V/H SYNC+Blank	Primary IDE 1	: Disabled
Video off After	: Standby	Secondary IDE 0	: Disabled
Modem Use IRQ	: 3	Secondary IDE 1	: Disabled
Doze Mode	: Disabled	Floppy Disk	: Disabled
Standby Mode	: Disabled	Serial Port	: Disabled
Suspend Mode	: Disabled	Parallel Port	: Disabled
HDD Power Down	: Disabled		
Throttle Duty Cycle	: 62.5%		
PCI/VGA Active Monitor	: Disabled		
Soft-off by PWB-BTTN	: Delay 4 Sec.		
CPUFAN Off In Suspend	: Enabled		
PowerOn by Ring	: Enabled		
Power Loss Recovery	: Disabled		
Resume by Alarm	: Disabled		
IRQ 8 Break Suspend	: Disabled		
		Esc : Quit	↑ ↓ → ← : Select Item
		F1 : Help	PU/PD/+/- : Modify
		F5 : Old Values	(Shift) F2 : Color
		F7 : Load Setup Defaults	

Figure 5: Power Management Setup

You can only change the content of Doze Mode, Standby Mode, and Suspend Mode when the Power Management is set to ‘User Define’.

**Power Management:** Use this to select your Power Management selection. The default is User define.

*Disabled:* The system operates in NORMAL conditions (Non-GREEN), and the Power Management function is disabled.

**Max. saving:** Maximum power savings. Inactivity period is 1 minute in each mode.

**Min. saving:** Minimum power savings. Inactivity period is 1 hour in each mode.

**User define:** Allows user to define PM Timers parameters to control power saving mode.

**PM controlled APM:** This option shows whether or not you want the Power Management to be controlled the Advanced Power Management (APM). The default is Yes.

**Yes:** APM controls your PM

**No:** APM does not control your PM

**Video Off Method:** This option allows you to select how the video will be disabled by the power management. The default is V/H Sync + Blank

**V/H Sync + Blank:** System turns off vertical and horizontal synchronization ports and writes blanks to the video buffer.

**DPMS:** Select this option if your monitor supports the Display Power Management Signaling (DPMS) standard of the Video Electronics Standards Association (VESA). Use the software supplied for your video subsystem to select video power management values.

**Blank Screen:** System only writes blanks to the video buffer.

**Video Off After:** Tells you what time frame that the video will be disabled under current power management settings. The default is Standby.

**Standby:** Video powers off after time shown in standby mode setting.

**Doze:** Video powers off after time shown in doze mode setting.

**Suspend:** Video powers off after time shown in suspend mode setting.

**N/A:** Video power off not controlled by power management.

**MODEM Use IRQ:** Name the interrupt request (IRQ) line assigned to the modem (if any) on your system. Activity of the selected IRQ always awakens the system. Default is IRQ 3.

**N/A:** No IRQ is used.      **3:** IRQ 3

**4:** IRQ 4                      **5:** IRQ 5

**7:** IRQ 7                      **9:** IRQ 9

**10:** IRQ 10                   **11:** IRQ 11

The EP-LX370Y supports HDD Power Down, Doze and Standby power saving functions when using the Intel Pentium II Processor.

The default is Disabled

**Doze Mode:** The “Doze” mode timer starts to count when no “PM events” have occurred.

**Standby Mode:** When the standby mode timer times-out, it will enter the standby mode and retain CPU at a slow working speed. The screen will be blanked out.

**Suspend Mode:** This function works only when the Pentium II Processor is installed. The timer starts to count when “System Standby” mode timer is timed out and no “PM Events” are occurring. Valid range is from 1 minute up to 1 hour.

**HDD Power Down:** HDD Standby timer can be set from 1 to 15 minute(s).

**PCI/VGA Act-Monitor:** Use this option if your monitor has advanced power saving features.

The default is Disabled

*Enabled:* Your monitor’s power features will be included in power management.

*Disabled:* Your monitor’s power features will not be included in power management.

**Soft-Off by PWR-BTTN:** Use this to select your soft-off function.

The default is Delay 4 Sec.

*Instant Off:* Turns off instantly.

*Delay 4 Sec:* Turns off after a 4 second delay. If momentary press of button, the system will go into Suspend Mode. Press again to take system out of Suspend Mode.

**Resume by Ring:** This option is used to set the remote ring in feature. This option is only available when Power Loss Recovery is Enabled.

The default is Enabled.

*Enabled:* The system can use remote ring-in to wake the system up.

*Disabled:* The system cannot use remote ring in to wake system up.

**Power Loss Recovery:** If the power to the system is cut off the system will turn itself back on with no user intervention.

The default is Disabled.

*Enabled:* The system will power back on after a power interruption.

*Disabled:* The system will stay off after a power interruption.

**Resume by Alarm:** This option allows you to have the system turn on at a preset time each day or on a certain day. This option is only available when Power Loss Recovery is Disabled.

The default is Disabled.

*Enabled:* The system will turn on at the preset time.

*Disabled:* The system will not turn on until you turn it on.

### **\*\*Reload Global Timer Events \*\***

These options allow the user to reset the global power features timer if any of the enabled events occur.

**IRQ [3-7, 9-15], NMI:** The default is Enable.

**Primary IDE 0:** The default is Disable.

**Primary IDE 1:** The default is Disable.

**Secondary IDE 0:** The default is Disable.

**Secondary IDE 1:** The default is Disable.

**Floppy Disk:** The default is Disable.

**Serial Port:** The default is Enable.

**Parallel Port:** The default is Disable.

## **4-5 PNP/PCI Configuration**

The PNP/PCI configuration program is for the user to modify the PCI/ISA IRQ signals when various PCI/ISA cards are inserted in the PCI or ISA slots.

**WARNING:** *Conflicting IRQ's may cause the system to not find certain devices.*

ROM PCI/ISA BIOS(2A69JPAC)  
 PNP/PCI CONFIGURATION  
 AWARD SOFTWARE, INC.

PNP OS Installed	: NO	Used MEM base addr	: N/A
Resources Controlled By	: Manual	Assign IRQ For VGA	: Enabled
Reset Configuration Data	: Disabled	Assign IRQ For USB	: Enabled
IRQ-3	assigned to : PCI/ISA PnP	PCI Latency Timer (CLK)	: 32
IRQ-4	assigned to : PCI/ISA PnP		
IRQ-5	assigned to : PCI/ISA PnP		
IRQ-7	assigned to : PCI/ISA PnP		
IRQ-9	assigned to : PCI/ISA PnP		
IRQ-10	assigned to : PCI/ISA PnP		
IRQ-11	assigned to : PCI/ISA PnP		
IRQ-12	assigned to : PCI/ISA PnP		
IRQ-14	assigned to : PCI/ISA PnP		
IRQ-15	assigned to : PCI/ISA PnP		
DMA-0	assigned to : PCI/ISA PnP		
DMA-1	assigned to : PCI/ISA PnP		
DMA-3	assigned to : PCI/ISA PnP		
DMA-5	assigned to : PCI/ISA PnP		
DMA-6	assigned to : PCI/ISA PnP		
DMA-7	assigned to : PCI/ISA PnP		
		Esc : Quit	↑ ↓ → ← : Select Item
		F1 : Help	PU/PD/+/- : Modify
		F5 : Old Values	(Shift) F2 : Color
		F7 : Load Setup Defaults	

Figure 6: PCI Configuration Setup

**PNP OS Installed:** Do you have a PNP OS installed on your system. The default is No.

*Yes:* Select if you are using a PNP OS

*No:* Select if your OS does not support PNP.

**Resources Controlled By:** Who controlled the system PNP/PCI resources. The default is Manual.

*Manual:* PNP Card's resources will be controlled manually. You can set which IRQ-X and DMA-X are assigned to PCI/ISA PNP or Legacy ISA Cards.

*Auto:* If your ISA card and PCI card are all PNP cards, BIOS will assign the interrupt resource automatically.

**Reset Configuration Data:** This setting allows you to clear ESCD data. The default is Disabled

*Disabled:* Normal Setting.

*Enabled:* If you have plugged in some Legacy cards to the system and they were recorded into ESCD (Extended System Configuration Data), you can set this field to Enabled in order to clear ESCD.

**PCI IDE IRQ Map To:** This item allows the user to configure the system for the type of IDE hard disk controller in use. By default, the BIOS assumes that the hard drive controller is an ISA device rather than a PCI controller. If you are using a PCI controller, then you will need to change this to specify which PCI slot has the controller and which PCI interrupt (A, B, C, or D) is associated with the connected IDE devices.

The default value is PCI-AUTO. This will allow the system to automatically configure the IDE devices.

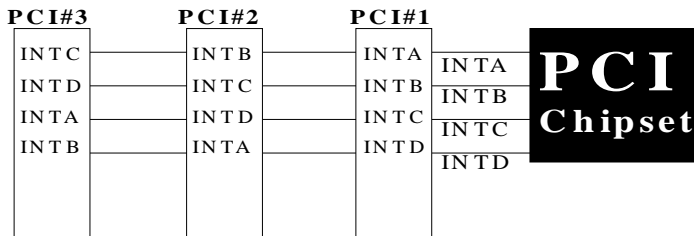

**Figure 7: The Combination of PCI INT#lines**

**Used MEM base addr:** The Used MEM base addr (CB00, CC00, D000, D400, D800, DC00) and Used MEM Length (8K, 16K, 32K, 64K) are used to support some specific ISA Legacy cards with requested memory space below 1M address. Now with these two functions, users can define where the used memory address is located and its length of the legacy area that is used by the legacy device to avoid the memory space conflict. For example, if you select “D000” for Used MEM base addr” and “16K” for “Used MEM Length”, that means the address region D000H-D3FFFH is occupied by ISA legacy cards, and thus BIOS will not assign this region for PnP/ISA and PCI cards.

The default is N/A.

### 4-6 Load Setup Defaults

The “LOAD SETUP DEFAULTS” function loads the system default data directly from ROM and initializes the associated hardware properly. This function will be necessary only when the system CMOS data is corrupted.

## 4-7 Integrated Peripherals

ROM PCI/ISA BIOS(2A69JPAC)  
 INTEGRATED PERIPHERALS  
 AWARD SOFTWARE, INC.

IDE HDD Block Mode : Enabled	Onboard Serial Port 2 : 2F8/IRQ3
IDE Primary Master PIO : Auto	Onboard IR Controller : Normal
IDE Primary Slave PIO : Auto	
IDE Secondary Master PIO : Auto	Onboard Parallel Port : 378/IRQ7
IDE Secondary Slave PIO : Auto	Parallel Port Mode : ECP+EPP
IDE Primary Master UDMA : Auto	ECP Mode Use DMA : 3
IDE Primary Slave UDMA : Auto	EPP Mode Select : EPP1.7
IDE Secondary Master UDMA : Auto	
IDE Secondary Slave UDMA : Auto	
Onboard Primary PCI IDE : Enabled	
Onboard Secondary PCI IDE : Enabled	
USB Keyboard Support : Disabled	
Init Display First : PCI Slot	
KBC input clock : 12MHz	Esc : Quit                   ↑ ↓ → ← : Select Item
Onboard FDC Controller : Enabled	F1 : Help                   PU/PD/+/- : Modify
Onboard Serial Port 1 : 3F8/IRQ4	F5 : Old Values           (Shift) F2 : Color
	F7 : Load Setup Defaults

Figure 8: Integrated Peripherals

**Note:** If you do not use the Onboard IDE connector, then you will need to set **Onboard Primary PCI IDE: Disabled** and **Onboard Secondary PCI IDE: Disabled**

**Note:** The Onboard PCI IDE cable should be equal to or less than 18 inches (45 cm.).

**IDE HDD Block Mode:** IDE Block Mode allows the controller to access blocks of sectors rather than a single sector at a time.

The default is Enabled.

**Enabled:** Enabled IDE HDD Block Mode. Provides higher HDD transfer rates.

**Disabled:** Disable IDE HDD Block Mode.

**Onboard Primary PCI IDE:** The default value is Enabled.

**Enabled:** Enables Onboard IDE primary port.

**Disabled:** Disables Onboard IDE primary port.

**Onboard Secondary PCI IDE:**

The default is Enabled.

**Enabled:** Enables Onboard IDE secondary port.

**Disabled:** Disables Onboard IDE secondary port.

**IDE Primary Master PIO**

The default is Auto.

*Auto:* BIOS will automatically detect the Onboard Primary Master PCI IDE HDD Accessing mode.

*Mode 0~4:* Manually set the IDE Programmed interrupt mode.

**IDE Primary Slave PIO**

The default is Auto.

*Auto:* BIOS will automatically detect the Onboard Primary Slave PCI IDE HDD Accessing mode.

*Mode 0~4:* Manually set the IDE Programmed interrupt mode.

**IDE Secondary Master PIO:**

The default is Auto.

*Auto:* BIOS will automatically detect the Onboard Secondary Master PCI IDE HDD Accessing mode.

*Mode 0~4:* Manually set the IDE Programmed interrupt mode.

**IDE Secondary Slave PIO:**

The default is Auto.

*Auto:* BIOS will automatically detect the Onboard Secondary Slave PCI IDE HDD Accessing mode.

*Mode 0~4:* Manually set the IDE Programmed interrupt mode.

**IDE Primary Master UDMA:** This allows you to select the mode of operation for the hard drive.

The default is Auto.

*Auto:* The computer will select the optimal setting.

*Disabled:* The hard drive will run in normal mode.

**IDE Primary Slave UDMA:** This allows you to select the mode of operation for the hard drive.

The default is Auto.

*Auto:* The computer will select the optimal setting.

*Disabled:* The hard drive will run in normal mode.

**IDE Secondary Master UDMA:** This allows you to select the mode of operation for the hard drive.



The default is Auto.

*Auto:* The computer will select the optimal setting.

*Disabled:* The hard drive will run in normal mode.

**IDE Secondary Slave UDMA:** This allows you to select the mode of operation for the hard drive.

The default is Auto.

*Auto:* The computer will select the optimal setting.

*Disabled:* The hard drive will run in normal mode.

**USB Keyboard Support:** This controls the activation status of an optional USB keyboard that may be attached.

The default is disabled.

*Enabled:* Enable USB keyboard support.

*Disabled:* Disable USB keyboard support.

**OnBoard Primary PCI IDE:** This option turns on and off the onboard primary IDE.

The default is Enabled.

*Enabled:* This activates the primary PCI IDE.

*Disabled:* This disables the primary PCI IDE and frees up the resource.

**OnBoard Secondary PCI IDE:** This option turns on/off the onboard secondary IDE.

The default is Enabled.

*Enabled:* This activates the secondary PCI IDE.

*Disabled:* This disables the secondary PCI IDE and frees up its resources.

**KBC input clock:** This sets the keyboard clock value.

The default is 12 MHz.

*Options:* 6, 8, 12, 16 are the available choices.

**Onboard FDC Controller:** This controls the state of the onboard floppy controller.

The default value is Enabled.

*Enabled:* Enable the Onboard Winbond Chips's floppy drive interface controller.

*Disabled:* Disable the Onboard Winbond Chip's floppy drive interface controller.

**Onboard Serial Port 1:** This field allows the user to configure the 1st serial port. The default is Auto.

- AUTO:* Enable Onboard Serial port 1 and address is Auto adjusted
- COM1:* Enable Onboard Serial port 1 and address is 3F8H/IRQ4.
- COM2:* Enable Onboard Serial port 1 and address is 2F8H/IRQ3.
- COM3:* Enable Onboard Serial port 1 and address is 3E8H/IRQ4.
- COM4:* Enable Onboard Serial port 1 and address is 2E8H/IRQ3.
- Disabled:* Disable Onboard Winbond Chip's CHIP's Serial port 1.

**Onboard Serial Port 2:** This field allows the user to configure the 2nd serial port. The default is 2F8/IRQ3.

- AUTO:* Enable Onboard Serial port 2 and address is Auto adjusted
- COM1:* Enable Onboard Serial port 2 and address is 3F8H/IRQ4.
- COM2:* Enable Onboard Serial port 2 and address is 2F8H/IRQ3.
- COM3:* Enable Onboard Serial port 2 and address is 3E8H/IRQ4.
- COM4:* Enable Onboard Serial port 2 and address is 2E8H/IRQ3.
- Disabled:* Disable Onboard Winbond Chip's CHIP's Serial port 2.

**Onboard Parallel port:** This field allows the user to configure the LPT port. The default is 378 / IRQ7.

- 378H:* Enable Onboard LPT port and address is 378H and IRQ7.
- 278H:* Enable Onboard LPT port and address is 278H and IRQ5.
- 3BCH:* Enable Onboard LPT port and address is 3BCH and IRQ7.
- Disabled:* Disable Onboard Winbond Chip's LPT port.

**Parallel Port Mode:** This field allows the user to select the parallel port mode. The default is ECP+EPP.

- Normal:* Standard mode. IBM PC/AT Compatible bidirectional parallel port.
- EPP:* Enhanced Parallel Port mode.
- ECP:* Extended Capabilities Port mode.
- EPP+ECP:* ECP Mode & EPP Mode.

**ECP Mode USE DMA:** This field allows the user to select DMA1 or DMA3 for the ECP mode. The default is DMA3.

- DMA1:* This field selects the routing of DMA1 for the ECP mode.
- DMA3:* This field selects the routing of DMA3 for the ECP mode.

## 4-8 Change Supervisor or User Password

---

To change the password, choose the “SUPERVISOR PASSWORD or USER PASSWORD” option from the CMOS SETUP UTILITY menu and press [Enter].

*NOTE: Either “Setup” or “System” must be selected in the “Security Option” of the BIOS FEATURES SETUP menu.*

1. If CMOS is corrupted or the option was not used, a default password stored in the ROM will be used. The screen will display the following message:

Enter Password:

Press the [Enter] key to continue after the proper password is given.

2. If the CMOS is corrupted or the option was used earlier and the user wishes to change the default password, the SETUP UTILITY will display a message and ask for a confirmation.

Confirm Password:

3. After pressing the [Enter] key (ROM password if the option was not used) or current password (user-defined password), the user can change the password and store new one in CMOS RAM. A maximum of 8 characters can be entered.

### 4-9 IDE HDD Auto Detection

The “IDE HDD auto detection” utility is a very useful tool, especially when you do not know which kind of hard disk type you are using. You can use this utility to detect the correct disk type installed in the system automatically. But now you can set HARD DISK TYPE to Auto in the STANDARD CMOS SETUP. You don’t need the “IDE HDD AUTO DETECTION” utility. The BIOS will Auto-detect the hard disk size and model on display during POST.

ROM PCI/ISA BIOS(2A69JPAC)  
 CMOS SETUP UTILITY  
 AWARD SOFTWARE, INC.

HARD DISKS	TYPE	SIZE	CYLS	HEADS	PRECOMP	LANDZONE	SECTORS	MODE
Primary Master :								
Select Secondary Slave Option (N=Skip) : N								
OPTIONS	SIZE	CYLS	HEAD	PRECOMP	LANDZ	SECTOR	MODE	
2 (Y)	4310	524	255	0	14847	63	LBA	
1	4310	14848	9	65535	14847	63	NORMAL	
3	4310	928	144	65535	14847	63	LARGE	
Note: Some OSes (like SCO-UNIX) must use NORMAL for installation								
ESC : Skip								

Figure 8: IDE HDD Auto Detection

**NOTE: HDD Modes**

The Award BIOS supports 3 HDD modes : NORMAL, LBA & LARGE NORMAL mode

Generic access mode in which neither the BIOS nor the IDE controller will make any transformations during accessing.

The maximum number of cylinders, head & sectors for NORMAL mode are.

- 1024, 16 & 63
- no. Cylinder (1024)
- x no. Head ( 16)
- x no. Sector ( 63)
- x no. per sector ( 512)
- 528 Megabytes

If user set his HDD to NORMAL mode, the maximum accessible HDD size will be 528 Megabytes even though its physical size may be greater than that!

**LBA (Logical Block Addressing) mode:** A new HDD accessing method to overcome the 528 Megabyte bottleneck. The number of cylinders, heads & sectors shown in setup may not be the number physically contained in the HDD. During HDD accessing, the IDE controller will transform the logical address described by sector, head & cylinder into its own physical address inside the HDD. The maximum HDD size supported by LBA mode is 8.4 GigaBytes which is obtained by the following formula:

$$\begin{aligned}
 &\text{no. Cylinder} && (1024) \\
 &x \text{ no. Head} && ( 255) \\
 &x \text{ no. Sector} && ( 63) \\
 &\underline{x \text{ bytes per sector}} && \underline{( 512)} \\
 &&& 8.4 \text{ GigaBytes}
 \end{aligned}$$

**LARGE mode:** Extended HDD access mode supported by Award Software.

Some IDE HDDs contain more than 1024 cylinder without LBA support (in some cases, user do not want LBA). The Award BIOS provides another alternative to support these kinds of LARGE mode.

<u>CYLS</u>	<u>HEADS</u>	<u>SECTOR</u>	<u>MODE</u>
1120	16	59	NORMAL
560	32	59	LARGE

BIOS tricks DOS (or other OS) that the number of cylinders is less than 1024 by dividing it by 2. At the same time, the number of heads is multiplied by 2. A reverse transformation process will be made inside

INT 12h in order to access the right HDD address!

**Maximum HDD size:**

$$\begin{aligned}
 &\text{no. Cylinder} && (1024) \\
 &x \text{ no. Head} && ( 32) \\
 &x \text{ no. Sector} && ( 63) \\
 &\underline{x \text{ bytes per sector}} && \underline{( 512)} \\
 &&& 1 \text{ GigaByte}
 \end{aligned}$$

*Note: To support LBA or LARGE mode of HDDs, there must be some software involved. All the software is located in the Award HDD Service Routine (INT 13h). It may fail to access a HDD with LBA (LARGE) mode selected if you are running under an Operating System which replaces the whole INT 13h.*

UNIX operating systems do not support either LBA or LARGE and must utilize the Standard mode. UNIX can support drives larger than 528MB.

## **4-10 HDD Low Level Format**

**Interleave:** Select the interleave number of the hard disk drive you wish to perform a low level format on. You may select from 1 to 8. Check the documentation that came with the drive for the correct interleave number, or select 0 for automatic detection.

**Auto scan bad track:** This allows the utility to scan first then format by each track.

**Start:** Press<Y>to start low level format.

## **4-11 Save & Exit Setup**

The “SAVE & EXIT SETUP” option will bring you back to the boot up procedure with all the changes you just recorded in the CMOS RAM.

## **4-12 Exit Without Saving**

The “EXIT WITHOUT SAVING” option will bring you back to normal boot up procedure without saving any data into CMOS RAM.

**All old data in the CMOS will not be destroyed.**

---

**Appendix A:**

---

**A-1 MEMORY MAP**

---

Address Range	Size	Description
[0000-7FFFF]	512K	Conventional memory
[8000-9FBFF]	127K	Extended Conventional memory
[9FC00-9FFFF]	1K	Extended BIOS data area if PS/2 mouse is installed
[A0000-C7FFF]	160K	Available for Hi DOS memory
[C8000-DFFFF]	96K	Available for Hi DOS memory and adapter ROMs
[E0000-EEFFF]	60K	Available for UMB
[EF000-EFFFF]	4K	Video service routine for Monochrome & CGA adaptor
[F0000-F7FFF]	32K	BIOS CMOS setup utility
[F8000-FCFFF]	20K	BIOS runtime service routine (2)
[FD000-FDFFF]	4K	Plug and Play ESCD data area
[FE000-FFFFF]	8K	BIOS runtime service routine (1)

**A-2 I/O MAP**

---

[000-01F]	DMA controller.(Master)
[020-021]	INTERRUPT CONTROLLER.(Master)
[022-023]	CHIPSET control registers. I/O ports.
[040-05F]	TIMER control registers.
[060-06F]	KEYBOARD interface controller.(8042)
[070-07F]	RTC ports & CMOS I/O ports.
[080-09F]	DMA register.
[0A0-0BF]	INTERRUPT controller.(Slave)
[0C0-0DF]	DMA controller.(Slave)
[0F0-0FF]	MATHCOPROCESSOR.
[1F0-1F8]	HARD DISK controller.
[278-27F]	PARALLEL port 2.
[2B0-2DF]	GRAPHICS adapter controller.
[2F8-2FF]	SERIAL port 2.
[360-36F]	NETWORK ports.
[378-37F]	PARALLEL port 1.
[3B0-3BF]	MONOCHROME & PARALLEL port adapter.
[3C0-3CF]	EGA adapter.

[3D0-3DF]	CGA adapter.
[3F0-3F7]	FLOPPY DISK controller.
[3F8-3FF]	SERIAL port 1.

### **A-3 TIMER & DMA CHANNELS MAP**

---

#### TIMER MAP:

TIMER Channel 0	System timer interrupt.
TIMER Channel 1	DRAM REFRESH request.
TIMER Channel 2	SPEAKER tone generator.

#### DMA CHANNELS:

DMA Channel 0	Available.
DMA Channel 1	Onboard ECP (Option).
DMA Channel 2	FLOPPY DISK (SMC CHIP).
DMA Channel 3	Onboard ECP (default).
DMA Channel 4	Cascade for DMA controller 1.
DMA Channel 5	Available.
DMA Channel 6	Available.
DMA Channel 7	Available

### **A-4 INTERRUPT MAP**

---

#### NMI :

Parity check error.

#### IRQ (H/W):

0	System TIMER interrupt from TIMER 0.
1	KEYBOARD output buffer full.
2	Cascade for IRQ 8-15.
3	SERIAL port 2.
4	SERIAL port 1.
5	PARALLEL port 2.
6	FLOPPY DISK (SMC CHIP).
7	PARALLEL port 1.
8	RTC clock.
9	Available.
10	Available.
11	Available.
12	PS/2 Mouse.
13	MATH coprocessor.

---



- 14 Onboard HARD DISK (IDE1) channel.
- 15 Onboard HARD DISK (IDE1) channel.

## **A-5 RTC & CMOS RAM MAP**

---

### RTC & CMOS:

- 00 Seconds.
- 01 Second alarm.
- 02 Minutes.
- 03 Minutes alarm.
- 04 Hours.
- 05 Hours alarm.
- 06 Day of week.
- 07 Day of month.
- 08 Month.
- 09 Year.
- 0A Status register A.
- 0B Status register B.
- 0C Status register C.
- 0D Status register D.
- 0E Diagnostic status byte.
- 0F Shutdown byte.
- 10 FLOPPY DISK drive type byte.
- 11 Reserve.
- 12 HARD DISK type byte.
- 13 Reserve.
- 14 Equipment type.
- 15 Base memory low byte.
- 16 Base memory high byte.
- 17 Extension memory low byte.
- 18 Extension memory high byte.
- 19-2d
- 2E-2F
- 30 Reserved for extension memory low byte.
- 31 Reserved for extension memory high byte.
- 32 DATE CENTURY byte.
- 33 INFORMATION FLAG.
- 34-3F Reserve.
- 40-7F Reserved for CHIPSET SETTING DATA.

---

**Appendix B:**

---



---

**B-1 POST CODES**

---

ISA POST codes are typically output to I/O port address 80h.

<b>POST (hex)</b>	<b>DESCRIPTION</b>
01-02	Reserved.
C0	Turn off OEM specific cache, shadow.
03	<ol style="list-style-type: none"> <li>1. Initialize EISA registers (EISA BIOS only).</li> <li>2. Initialize all the standard devices with default values</li> </ol> Standard devices includes. <ul style="list-style-type: none"> <li>- DMA controller (8237).</li> <li>- Programmable Interrupt Controller (8259).</li> <li>- Programmable Interval Timer (8254).</li> <li>- RTC chip.</li> </ul>
04	Reserved
05	1. Keyboard Controller Self-Test.
06	2. Enable Keyboard Interface.
07	Reserved.
08	Verifies CMOS's basic R/W functionality.
C1	Auto-detection of onboard DRAM & Cache.
C5	Copy the BIOS from ROM into E0000-FFFFFF shadow RAM so that POST will go faster.
08	Test the first 256K DRAM.
09	OEM specific cache initialization. (if needed)
0A	<ol style="list-style-type: none"> <li>1. Initialize the first 32 interrupt vectors with corresponding Interrupt handlers. Initialize INT numbers from 33-120 with Dummy (Spurious) Interrupt Handler.</li> <li>2. Issue CUID instruction to identify CPU type.</li> <li>3. Early Power Management initialization. (OEM specific)</li> </ol>
0B	<ol style="list-style-type: none"> <li>1. Verify the RTC time is valid or not.</li> <li>2. Detect bad battery.</li> <li>3. Read CMOS data into BIOS stack area.</li> <li>4. PnP initializations including. (PnP BIOS only)               <ul style="list-style-type: none"> <li>- Assign CSN to PnP ISA card.</li> <li>- Create resource map from ESCD.</li> </ul> </li> <li>5. Assign IO &amp; Memory for PCI devices. (PCI BIOS only)</li> </ol>

---

0C	Initialization of the BIOS Data Area. (40:ON - 40:FF)
0D	<ol style="list-style-type: none"><li>1. Program some of the Chipset's value according to Setup. (Early Setup Value Program)</li><li>2. Measure CPU speed for display &amp; decide the system clock speed.</li><li>3. Video initialization including Monochrome, CGA, EGA/VGA. If no display device found, the speaker will beep.</li></ol>
0E	<ol style="list-style-type: none"><li>1. Test video RAM. (If Monochrome display device found)</li><li>2. Show messages including.<ul style="list-style-type: none"><li>- Award Logo, Copyright string, BIOS Data code &amp; Part No.</li><li>- OEM specific sign on messages.</li><li>- Energy Star Logo. (Green BIOS ONLY)</li><li>- CPU brand, type &amp; speed.</li><li>- Test system BIOS checksum. (Non-Compress Version only)</li></ul></li></ol>
0F	DMA channel 0 test.
10	DMA channel 1 test.
11	DMA page registers test.
12-13	Reserved.
14	Test 8254 Timer 0 Counter 2.
15	Test 8259 interrupt mask bits for channel 1.
16	Test 8259 interrupt mask bits for channel 2.
17	Reserved.
19	Test 8259 functionality.
1A-1D	Reserved.
1E	If EISA NVM checksum is good, execute EISA initialization. (EISA BIOS only)
1F-29	Reserved.
30	Detect Base Memory & Extended Memory Size.
31	<ol style="list-style-type: none"><li>1. Test Base Memory from 256K to 640K.</li><li>2. Test Extended Memory from 1M to the top of memory.</li></ol>
32	<ol style="list-style-type: none"><li>1. Display the Award Plug &amp; Play BIOS Extension message. (PnP BIOS only)</li><li>2. Program all onboard super I/O chips (if any) including COM ports, LPT ports, FDD port ... according to setup value.</li></ol>
33-3B	Reserved.
3C	Set flag to allow users to enter CMOS Setup Utility.
3D	<ol style="list-style-type: none"><li>1. Initialize Keyboard.</li><li>2. Install PS2 mouse.</li></ol>

---

- 3E Try to turn on Level 2 cache.  
**Note:** Some chipset may need to turn on the L2 cache in this stage. But usually, the cache is turn on later in POST 61h.
- 3F-40 Reserved.
- BF 1. Program the rest of the Chipset's value according to Setup. (Later Setup Value Program)
- 41 2. If auto-configuration is enabled, program the chipset with pre-defined Values.
- 42 Initialize floppy disk drive controller.
- 43 Initialize Hard drive controller.
- 45 If it is a PnP BIOS, initialize serial & parallel ports.
- 44 Reserved.
- 45 Initialize math coprocessor.
- 46-4D Reserved.
- 4E If there is any error detected (such as video, kb...), show all error messages on the screen & wait for user to press <F1> key.
- 4F 1. If password is needed, ask for password.  
2. Clear the Energy Star Logo. (Green BIOS only)
- 50 Write all CMOS values currently in the BIOS stack area back into the CMOS.
- 51 Reserved.
- 52 1. Initialize all ISA ROMs.  
2. Later PCI initializations. (PCI BIOS only)  
- assign IRQ to PCI devices.  
- initialize all PCI ROMs.  
3. PnP Initialzations. (PnP BIOS only)  
- assign IO, Memory, IRQ & DMA to PnP ISA devices.  
- initialize all PnP ISA ROMs.  
4. Program shadows RAM according to Setup settings.  
5. Program parity according to Setup setting.  
6. Power Management Initialization.  
- Enable/Disable global PM.  
- APM interface initialization.
- 53 1. If it is NOT a PnP BIOS, initialize serial & parallel ports.  
2. Initialize time value in BIOS data area by translate the RTC time value into a timer tick value.
- 60 Setup Virus Protection. (Boot Sector Protection) functionality according to Setup setting.

- 61                    1. Try to turn on Level 2 cache.  
 Note: If L2 cache is already turned on in POST 3D, this part will be skipped.  
 2. Set the boot up speed according to Setup setting.  
 3. Last chance for Chipset initialization.  
 4. Last chance for Power Management initialization. (Green BIOS only)  
 5. Show the system configuration table.
- 62                    1. Setup daylight saving according to Setup value.  
 2. Program the NUM Lock, typematic rate & typematic speed according to Setup setting.
- 63                    1. If there is any changes in the hardware configuration, update the ESCD information. (PnP BIOS only)  
 2. Clear memory that have been used.  
 3. Boot system via INT 19H.
- FF                    System Booting. This means that the BIOS already pass the control right to the operating system.

## **B-2 Unexpected Errors:**

---

<b>POST (hex)</b>	<b>DESCRIPTION</b>
B0	If interrupt occurs in protected mode.
B1	Unclaimed NMI occurs.0

Appendix C

NOTE: The "LOAD SETUP DEFAULTS" function loads the system default data directly from ROM and initializes the associated hardware properly. This function will be necessary when you accept this mainboard, or the system CMOS data is corrupted.

ROMPCI/ISA BIOS(2A69KPA9)
CMOS SETUP UTILITY
AWARD SOFTWARE, INC.

STANDARD CMOS SETUP SUPERVISOR PASSWORD
BIOS FEATURES SETUP USER PASSWORD
CHIPSET FEATURES SETUP IDE HDD AUTO DETECTION
POWER MANAGEMENT SETUP HDD LOW LEVEL FORMAT
PNP/PCI CONFIGURATION SETUP SAVING
INTEGRATED PERIPHERALS
LOAD SETUP DEFAULTS
ESC: QUIT
F10: Save & Exit Setup
Load SETUP Default (Y/N)? Y
Up/Down/Right arrows: SELECT ITEM
(Shift)F2: Change Color
Load Setup Defaults Except Standard COMS SETUP

LOAD SETUP DEFAULTS