



K7V88

User Manual

Version 1.0

Published March 2004

Copyright©2004 ASRock INC. All rights reserved.

Copyright Notice:

No part of this manual may be reproduced, transcribed, transmitted, or translated in any language, in any form or by any means, except duplication of documentation by the purchaser for backup purpose, without written consent of ASRock Inc.

Products and corporate names appearing in this manual may or may not be registered trademarks or copyrights of their respective companies, and are used only for identification or explanation and to the owners' benefit, without intent to infringe.

Disclaimer:

Specifications and information contained in this manual are furnished for informational use only and subject to change without notice, and should not be constructed as a commitment by ASRock. ASRock assumes no responsibility for any errors or omissions that may appear in this manual.

With respect to the contents of this manual, ASRock does not provide warranty of any kind, either expressed or implied, including but not limited to the implied warranties or conditions of merchantability or fitness for a particular purpose.

In no event shall ASRock, its directors, officers, employees, or agents be liable for any indirect, special, incidental, or consequential damages (including damages for loss of profits, loss of business, loss of data, interruption of business and the like), even if ASRock has been advised of the possibility of such damages arising from any defect or error in the manual or product.



This device complies with Part 15 of the FCC Rules. Operation is subject to the following two conditions:

- (1) this device may not cause harmful interference, and
- (2) this device must accept any interference received, including interference that may cause undesired operation.

ASRock Website: <http://www.asrock.com>

Contents

1. Introduction	5
1.1 Package Contents	5
1.2 Specifications	6
1.3 Motherboard Layout	8
1.4 ASRock I/O Plus™	9
2. Installation	10
Pre-installation Precautions	10
2.1 CPU Installation	11
2.2 Installation of CPU Fan and Heatsink	11
2.3 Installation of Memory Modules (DIMM)	12
2.4 Expansion Slots (PCI and AGP Slots)	14
2.5 Jumpers Setup	15
2.6 Onboard Headers and Connectors	17
2.7 Serial ATA (SATA) Hard Disks Installation	20
2.8 Hot Plug and Hot Swap Functions for SATA HDDs	20
2.9 Making An SATA Driver Diskette	21
3. BIOS SETUP UTILITY	22
3.1 Introduction	22
3.1.1 BIOS Menu Bar	22
3.1.2 Navigation Keys	23
3.2 Main Screen	23
3.3 Advanced Screen	24
3.3.1 CPU Configuration	24
3.3.2 Chipset Configuration	25
3.3.3 ACPI Configuration	27
3.3.4 IDE Configuration	28
3.3.5 PCIPnP Configuration	30
3.3.6 Floppy Configuration	30
3.3.7 Super IO Configuration	31
3.3.8 USB Configuration	32
3.4 Hardware Health Event Monitoring Screen	33
3.5 Boot Screen	33
3.5.1 Boot Settings Configuration	34
3.5.2 Boot Device Priority	34
3.6 Security Screen	35
3.7 Exit Screen	36

4. Software Support	37
4.1 Install Operating System	37
4.2 Support CD Information	37
4.2.1 Running Support CD	37
4.2.2 Drivers Menu	37
4.2.3 Utilities Menu	37
4.2.4 ASRock "PC-DIY Live Demo" Program	37
4.2.5 Contact Information	37

1. Introduction

Thank you for purchasing ASRock K7V88 motherboard, a reliable motherboard produced under ASRock's consistently stringent quality control. It delivers excellent performance with robust design conforming to ASRock's commitment to quality and endurance.

In this manual, chapter 1 and 2 contain introduction of the motherboard and step-by-step guide to the hardware installation. Chapter 3 and 4 contain the configuration guide to BIOS setup and information of the Support CD.



Because the motherboard specifications and the BIOS software might be updated, the content of this manual will be subject to change without notice. In case any modifications of this manual occur, the updated version will be available on ASRock website without further notice. You may find the latest memory and CPU support lists on ASRock website as well. ASRock website <http://www.asrock.com>

1.1 Package Contents

ASRock K7V88 Motherboard

(ATX Form Factor: 12.0-in x 8.0-in, 30.5 cm x 20.3 cm)

ASRock K7V88 Quick Installation Guide

ASRock K7V88 Support CD

One 80-conductor Ultra ATA 66/100/133 IDE Ribbon Cable

One Ribbon Cable for a 3.5-in Floppy Drive

One Serial ATA (SATA) Data Cable

One Serial ATA (SATA) HDD Power Cable(Optional)

One ASRock I/O Plus™ Shield

1.2 Specifications

Platform:	ATX Form Factor: 12.0-in x 8.0-in, 30.5 cm x 20.3 cm
CPU:	Supports Socket A (462 pins) for AMD Athlon™ / Athlon™ XP / Duron™ processor
Chipsets:	North Bridge: VIA KT880, FSB @ 400 MHz South Bridge: VIA VT8237, supports USB 2.0, ATA 133, SATA 1.5Gb/s
Memory:	4 DDR DIMM Slots: DDR1, DDR2, DDR3, and DDR4 Support PC3200 (DDR400) / PC2700 (DDR333) / PC2100 (DDR266), Max. 4GB Dual Channel Memory Technology support (see CAUTION 1)
IDE:	IDE1: ATA 133 / Ultra DMA Mode 6 IDE2: ATA 133 / Ultra DMA Mode 6 Support up to 4 IDE devices
Serial ATA:	2 SATA connectors Support 1.5Gb/s data transfer rate
Floppy Port:	Supports up to 2 floppy disk drives
Audio:	5.1 channels AC'97 Audio
LAN:	Speed: 802.3u (10/100 Ethernet), supports Wake-On-LAN
Hardware Monitor:	CPU temperature sensing (ASRock U-COP) Chassis temperature sensing CPU overheat shutdown to protect CPU life (ASRock U-COP)(see CAUTION 2) CPU fan tachometer Chassis fan tachometer Voltage monitoring: +12V, +5V, +3V, Vcore
PCI slots:	5 slots with PCI Specification 2.3
AGP slot:	1 AGP slot, supports 1.5V, 8X/4X AGP card (see CAUTION 3)
USB 2.0:	8 USB 2.0 ports: include 6 ready-to-use USB 2.0 ports on the rear panel, plus one on-board header supporting 2 extra USB 2.0 ports (see CAUTION 4)
ASRock I/O Plus™:	1 PS/2 mouse port, 1 PS/2 keyboard port, 1 serial port: COM1, 1 parallel port: ECP/EPP support, 6 ready-to-use USB 2.0 ports, 1 RJ 45 port, Audio Jack: Line In / Line Out / Microphone

BIOS:	AMI BIOS Supports "Plug and Play" ACPI 1.1 compliance wake up events SMBIOS 2.3.1 support CPU frequency stepless control (only for advanced users' reference, see CAUTION 5)
OS:	Microsoft® Windows® 98SE / ME / 2000 / XP compliant

CAUTION!

1. This motherboard supports Dual Channel Memory Technology. Before you implement Dual Channel Memory Technology, make sure to read the installation guide of memory modules on page 12 for proper installation.
2. While CPU overheat is detected, the system will automatically shutdown. Before you resume the system, please check if the CPU fan on the motherboard functions properly and unplug the power cord, then plug it back again. To improve heat dissipation, remember to spray thermal grease between the CPU and the heatsink when you install the PC system.
3. Do NOT use a 3.3V AGP card on the AGP slot of this motherboard!
It may cause permanent damage!
4. Power Management for USB 2.0 works fine under Microsoft® Windows® XP SP1 / 2000 SP4. It may not work properly under Microsoft® Windows® 98 / ME. Please refer to Microsoft® official document at <http://www.microsoft.com/whdc/hwdev/bus/USB/USB2support.mspix>
5. Although this motherboard offers stepless control, it is not recommended to perform over clocking. Frequencies other than the recommended CPU bus frequencies may cause the instability of the system or damage the CPU. The CPU host frequency of this motherboard is determined by the jumper-setting. To perform over-clocking, you must set the FSB jumper according to your AMD CPU before you use the "Manual" option as the FSB setting in BIOS setup. Please check page 22 for details.

1.3 Motherboard Layout

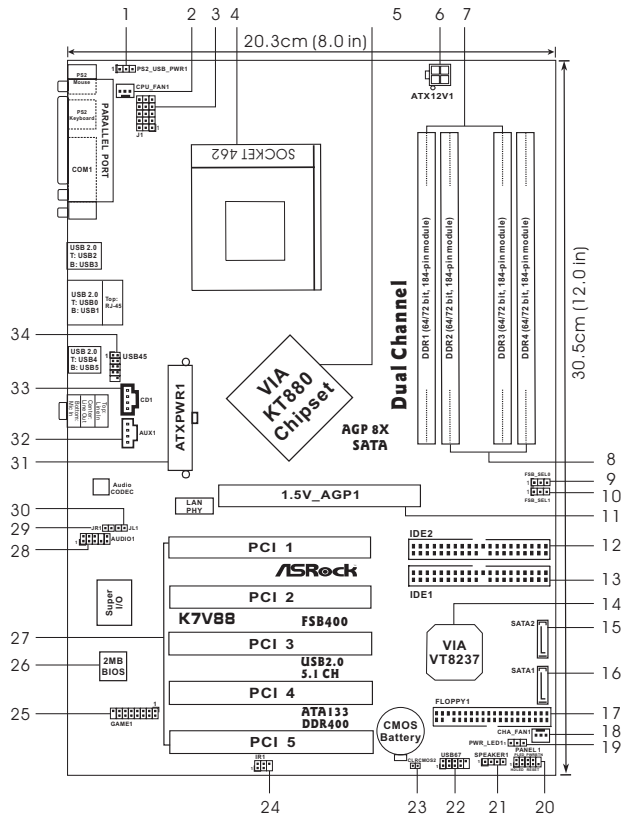

- | | | | |
|----|---|----|--|
| 1 | PS2_USB_PWR1 Jumper | 17 | Floppy Connector (FLOPPY1) |
| 2 | CPU Fan Connector (CPU_FAN1) | 18 | Chassis Fan Connector (CHA_FAN1) |
| 3 | CPU Multiplier Jumper (J1) | 19 | Power LED Header (PWR_LED1) |
| 4 | CPU Socket | 20 | System Panel Header (PANEL1) |
| 5 | North Bridge Controller | 21 | Chassis Speaker Header (SPEAKER 1) |
| 6 | ATX 12V Connector (ATX12V1) | 22 | USB 2.0 Header (USB67, Blue) |
| 7 | 2 x 184-pin DDR DIMM Slots
(Dual Channel A: DDR1, DDR3; Blue) | 23 | Clear CMOS Jumper (CLR_CMOS2) |
| 8 | 2 x 184-pin DDR DIMM Slots
(Dual Channel B: DDR2, DDR4; Black) | 24 | Infrared Module Header (IR1) |
| 9 | FSB Select Jumper (FSB_SEL0) | 25 | Game Port Connector (GAME1) |
| 10 | FSB Select Jumper (FSB_SEL1) | 26 | Flash Memory |
| 11 | AGP Slot (1.5V_AGP1) | 27 | 5 x PCI Slots (PCI1-5) |
| 12 | Secondary IDE Connector (IDE2, Black) | 28 | Front Panel Audio Header (AUDIO1) |
| 13 | Primary IDE Connector (IDE1, Blue) | 29 | JR1 Jumper |
| 14 | South Bridge Controller | 30 | JL1 Jumper |
| 15 | Secondary Serial ATA Connector (SATA2) | 31 | ATX Power Connector (ATXPWR1) |
| 16 | Primary Serial ATA Connector (SATA1) | 32 | Internal Audio Connector: AUX1 (White) |
| | | 33 | Internal Audio Connector: CD1 (Black) |
| | | 34 | Shared USB 2.0 Header (USB45, Blue) |

1.4 ASRock I/O Plus™

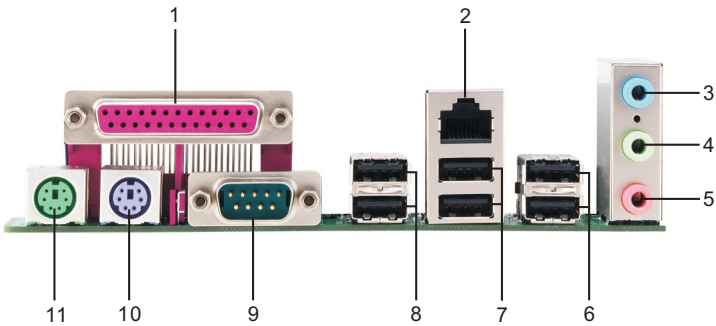

- | | | | |
|---|---------------------------------------|----|--------------------------------|
| 1 | Parallel Port | 7 | 2 x USB 2.0 Ports (USB0, USB1) |
| 2 | RJ-45 Port | 8 | 2 x USB 2.0 Ports (USB2, USB3) |
| 3 | Line In (Light Blue) | 9 | Serial Port: COM1 |
| 4 | Line Out (Lime) | 10 | PS/2 Keyboard Port (Purple) |
| 5 | Microphone (Pink) | 11 | PS/2 Mouse Port (Green) |
| 6 | 2 x Shared USB 2.0 Ports (USB4, USB5) | | |

2. Installation

K7V88 is an ATX form factor (12.0-in x 8.0-in, 30.5 cm x 20.3 cm) motherboard. Before you install the motherboard, study the configuration of your chassis to ensure that the motherboard fits into it.

Pre-installation Precautions

Take note of the following precautions before you install motherboard components or change any motherboard settings.

1. Unplug the power cord from the wall socket before touching any component.
2. To avoid damaging the motherboard components due to static electricity, **NEVER** place your motherboard directly on the carpet or the like. Also remember to use a grounded wrist strap or touch a safety grounded object before you handle components.
3. Hold components by the edges and do not touch the ICs.
4. Whenever you uninstall any component, place it on a grounded anti-static pad or in the bag that comes with the component.



Before you install or remove any component, ensure that the power is switched off or the power cord is detached from the power supply. Failure to do so may cause severe damage to the motherboard, peripherals, and/or components.

2.1 CPU Installation

- Step 1. Unlock the socket by lifting the lever up to a 90° angle.
- Step 2. Position the CPU directly above the socket such that its marked corner matches the base of the socket lever.
- Step 3. Carefully insert the CPU into the socket until it fits in place.



The CPU fits only in one correct orientation. DO NOT force the CPU into the socket to avoid bending of the pins.

- Step 4. When the CPU is in place, press it firmly on the socket while you push down the socket lever to secure the CPU. The lever clicks on the side tab to indicate that it is locked.



Step 1



Step 2, 3



Step 4

2.2 Installation of CPU Fan and Heatsink

This motherboard adopts 462-pin CPU socket to support AMD Athlon XP / Duron CPU. It requires larger heatsink and cooling fan to dissipate heat. You also need to spray thermal grease between the CPU and the heatsink to improve heat dissipation. Make sure that the CPU and the heatsink are securely fastened and in good contact with each other. Then connect the CPU fan to the CPU_FAN connector (CPU_FAN1, see p.8 No. 2). For proper installation, please kindly refer to the instruction manuals of the CPU fan and the heatsink.

2.3 Installation of Memory Modules (DIMM)

K7V88 motherboard provides four 184-pin DDR (Double Data Rate) DIMM slots, and supports Dual Channel Memory Technology. For dual channel configuration, you always need to install **identical** (the same brand, speed, size and chip-type) DDR DIMM pair in the slots of the same color. In other words, you have to install **identical** DDR DIMM pair in **Dual Channel A** (DDR1 and DDR3; Blue slots; see p.8 No.7) or **identical** DDR DIMM pair in **Dual Channel B** (DDR2 and DDR4; Black slots; see p.8 No.8), so that Dual Channel Memory Technology can be activated. This motherboard also allows you to install four DDR DIMMs for dual channel configuration, and please install **identical** DDR DIMMs in all four slots. You may refer to the Dual Channel Memory Configuration Table below.

Dual Channel Memory Configurations

	DDR1 (Blue Slot)	DDR2 (Black Slot)	DDR3 (Blue Slot)	DDR4 (Black Slot)
(1)	Populated	-	Populated	-
(2)	-	Populated	-	Populated
(3)	Populated	Populated	Populated	Populated



1. If you want to install two memory modules, for optimal compatibility and reliability, it is recommended to install them in the slots of the same color. In other words, install them either in the set of blue slots (DDR1 and DDR3), or in the set of black slots (DDR2 and DDR4).
2. If only one memory module or three memory modules are installed in the DDR DIMM slots on this motherboard, it is unable to activate the Dual Channel Memory Technology.
3. If a pair of memory modules is NOT installed in the same Dual Channel, for example, installing a pair of memory modules in DDR1 and DDR2, it is unable to activate the Dual Channel Memory Technology .

Installing a DIMM



Please make sure to disconnect power supply before adding or removing DIMMs or the system components.

- Step 1. Unlock a DIMM slot by pressing the retaining clips outward.
- Step 2. Align a DIMM on the slot such that the notch on the DIMM matches the break on the slot.

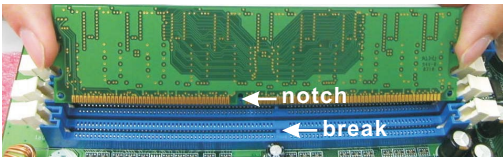
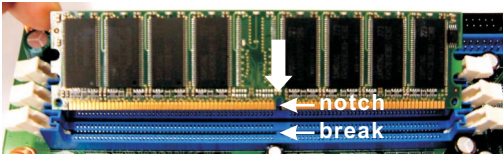

The DIMM only fits in one correct orientation. It will cause permanent damage to the motherboard and the DIMM if you force the DIMM into the slot at incorrect orientation.

- Step 3. Firmly insert the DIMM into the slot until the retaining clips at both ends fully snap back in place and the DIMM is properly seated.

2.4 Expansion Slots (PCI and AGP Slots)

There are 5 PCI slots and 1 AGP slot on K7V88 motherboard.

PCI slots: PCI slots are used to install expansion cards that have the 32-bit PCI interface.

AGP slot: The AGP slot is used to install a graphics card. The ASRock AGP slot has a special design of clasp that can securely fasten the inserted graphics card.



Please do NOT use a 3.3V AGP card on the AGP slot of this motherboard! It may cause permanent damage! For the voltage information of your AGP card, please check with the AGP card vendors.

Installing an expansion card

- Step 1. Before installing the expansion card, please make sure that the power supply is switched off or the power cord is unplugged. Please read the documentation of the expansion card and make necessary hardware settings for the card before you start the installation.
- Step 2. Remove the system unit cover (if your motherboard is already installed in a chassis).
- Step 3. Remove the bracket facing the slot that you intend to use. Keep the screws for later use.
- Step 4. Align the card connector with the slot and press firmly until the card is completely seated on the slot.
- Step 5. Fasten the card to the chassis with screws.
- Step 6. Replace the system cover.

2.5 Jumpers Setup

The illustration shows how jumpers are setup. When the jumper cap is placed on pins, the jumper is “Short”. If no jumper cap is placed on pins, the jumper is “Open”. The illustration shows a 3-pin jumper whose pin1 and pin2 are “Short” when jumper cap is placed on these 2 pins.

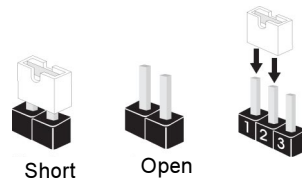

Jumper	Setting	
PS2_USB_PWR1 (see p.8, No. 1)		Short pin2, pin3 to enable +5VSB (standby) for PS/2 or USB wake up events.

Note: To select +5VSB, it requires 2 Amp and higher standby current provided by power supply.

JR1 (see p.8, No. 29)	
JL1 (see p.8, No. 30)	

Note: If the jumpers JL1 and JR1 are short, both the front panel and the rear panel audio connectors can work.

Clear CMOS (CLRCMOS2, 2-pin jumper) (see p.8, No. 23)		2-pin jumper
---	--	--------------

Note: CLRCMOS2 allows you to clear the data in CMOS. The data in CMOS includes system setup information such as system password, date, time, and system setup parameters. To clear and reset the system parameters to default setup, please turn off the computer and unplug the power cord, then use a jumper cap to short the pins on CLRCMOS2 for 3 seconds. Please remember to remove the jumper cap after clearing the CMOS. If you need to clear the CMOS when you just finish updating the BIOS, you must boot up the system first, and then shut it down before you do the clear-CMOS action.

FSB_SELO (see p.8, No. 9)	FSB_SELO	FSB_SELO	FSB_SELO	FSB_SELO
FSB_SEL1 (see p.8, No. 10)	FSB_SEL1	FSB_SEL1	FSB_SEL1	FSB_SEL1
	FSB 200MHz	FSB 266MHz	FSB 333MHz	FSB 400MHz

Note: The setting of the CPU front side bus frequency of this motherboard is by means of the adjustment of jumper-setting. To perform over clocking, you must set the FSB jumper according to your AMD CPU before you use the “Manual” option as the FSB setting in BIOS setup. Please follow the figures above to set the CPU front side bus frequency.

CPU Multiplier Jumper

(J1, 5 x 3-pin)
(see p.8 No. 3)



Note: The set of CPU Multiplier Jumper is only for advanced users to adjust the multiplier of CPU. Please follow the table below to adjust the multiplier of CPU. However, the system will work well without the adjustment of multiplier. You do not have to adjust the multiplier for normal usage.

Multiplier	FID0	FID1	FID2	FID3	FID4
5x	2-3	2-3	1-2	2-3	2-3
5.5x	1-2	2-3	1-2	2-3	2-3
6x	2-3	1-2	1-2	2-3	2-3
6.5x	1-2	1-2	1-2	2-3	2-3
7x	2-3	2-3	2-3	1-2	2-3
7.5x	1-2	2-3	2-3	1-2	2-3
8x	2-3	1-2	2-3	1-2	2-3
8.5x	1-2	1-2	2-3	1-2	2-3
9x	2-3	2-3	1-2	1-2	2-3
9.5x	1-2	2-3	1-2	1-2	2-3
10x	2-3	1-2	1-2	1-2	2-3
10.5x	1-2	1-2	1-2	1-2	2-3
11x	2-3	2-3	2-3	2-3	2-3
11.5x	1-2	2-3	2-3	2-3	2-3
12x	2-3	1-2	2-3	2-3	2-3
12.5x	1-2	1-2	2-3	2-3	2-3
13x	2-3	2-3	1-2	2-3	1-2
13.5x	1-2	2-3	1-2	2-3	1-2
14x	2-3	1-2	1-2	2-3	1-2
15x	2-3	2-3	2-3	1-2	1-2
16x	2-3	1-2	2-3	1-2	1-2
16.5x	1-2	1-2	2-3	1-2	1-2
17x	2-3	2-3	1-2	1-2	1-2
18x	1-2	2-3	1-2	1-2	1-2
19x	1-2	2-3	2-3	2-3	1-2
20x	1-2	1-2	2-3	2-3	1-2
21x	1-2	1-2	1-2	2-3	1-2
22x	1-2	2-3	2-3	1-2	1-2
23x	2-3	1-2	1-2	1-2	1-2
24x	1-2	1-2	1-2	1-2	1-2

For example, "Athlon XP 2000+" is an 1666MHz CPU: 12.5 (Multiplier) X 133MHz (External frequency) = 1666MHz

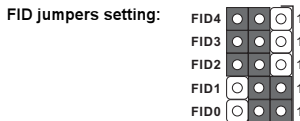

The jumper caps are not provided by ASRock. Please understand that ASRock does not guarantee and support the adjustment of multiplier. These jumpers setting may not apply to all multiplier-locked or even some unlocked AMD CPU. Frequencies other than the recommended CPU bus frequencies may cause the instability of the system or damage the CPU.

2.6 Onboard Headers and Connectors



Onboard headers and connectors are NOT jumpers. Do NOT place jumper caps over these headers and connectors. Placing jumper caps over the headers and connectors will cause permanent damage of the motherboard!

FDD Connector

(33-pin FLOPPY1)
(see p.8, No. 17)



Note: Make sure the red-striped side of the cable is plugged into Pin1 side of the connector.

Primary IDE Connector (Blue)

(39-pin IDE1, see p.8, No. 13)



Secondary IDE Connector (Black)

(39-pin IDE2, see p.8, No. 12)



connect the blue end
to the motherboard



connect the black end
to the IDE devices

80-conductor ATA 66/100/133 cable

Note: If you use only one IDE device on this motherboard, please set the IDE device as "Master". Please refer to the instruction of your IDE device vendor for the details. Besides, to optimize compatibility and performance, please connect your hard disk drive to the primary IDE connector (IDE1, blue) and CD-ROM to the secondary IDE connector (IDE2, black).

Serial ATA Connectors

(SATA1: see p.8, No. 16)

(SATA2: see p.8, No. 15)



These two Serial ATA (SATA) connectors support SATA data cables for internal storage devices. The current SATA interface allows up to 1.5 Gb/s data transfer rate.

Serial ATA (SATA) Data Cable



Either end of the SATA data cable can be connected to the SATA hard disk or the SATA connector on the motherboard.

Serial ATA (SATA)

Power Cable

(Optional)

connect to the SATA HDD
power connector

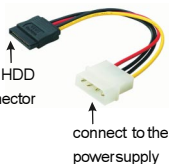

connect to the
powersupply

Please connect the black end of SATA power cable to the power connector on the drive. Then connect the white end of SATA power cable to the power connector of the power supply.

USB 2.0 Header

(9-pin USB67)

(see p.8, No. 22)

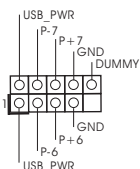

ASRock I/O Plus™ provides you 6 ready-to-use USB 2.0 ports on the rear panel. If the rear USB ports are not sufficient, this USB 2.0 header is available to support 2 extra USB 2.0 ports.

Shared USB 2.0 Header

(9-pin USB45)

(see p.8, No. 34)

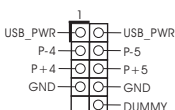

This USB45 connector is shared with the USB 2.0 ports 4,5 on ASRock I/O Plus™. When using the front panel USB ports by attaching the front panel USB cable to this connector (USB45), the USB ports 4,5 on ASRock I/O Plus™ will not be able to function.

Infrared Module Header

(5-pin IR1)

(see p.8, No. 24)

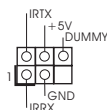

This header supports an optional wireless transmitting and receiving infrared module.

Internal Audio Connectors

(4-pin CD1, 4-pin AUX1)

(CD1: see p.8, No. 33)

(AUX1: see p.8, No. 32)

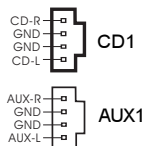

These connectors allow you to receive stereo audio input from sound sources such as a CD-ROM, DVD-ROM, TV tuner card, or MPEG card.

Front Panel Audio Header

(9-pin AUDIO1)

(see p.8, No. 28)

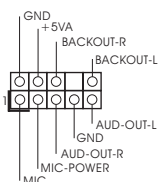

This is an interface for the front panel audio cable that allows convenient connection and control of audio devices.

System Panel Header

(9-pin PANEL1)

(see p.8, No. 20)

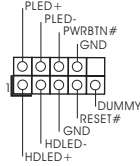

This header accommodates several system front panel functions.

Chassis Speaker Header

(4-pin SPEAKER 1)

(see p.8, No. 21)

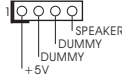

Please connect the chassis speaker to this header.

Chassis Fan Connector

(3-pin CHA_FAN1)

(see p.8, No. 18)

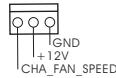

Please connect the chassis fan cable to this connector and match the black wire to the ground pin.

CPU Fan Connector

(3-pin CPU_FAN1)

(see p.8, No. 2)

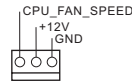

Please connect the CPU fan cable to this connector and match the black wire to the ground pin.

Game Connector

(15-pin GAME1)

(see p.8, No. 25)

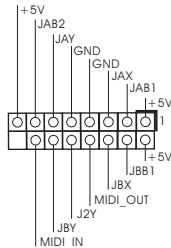

Connect a Game cable to this connector if the Game port bracket is installed.

ATX Power Connector

(20-pin ATXPWR1)

(see p.8, No. 31)



Please connect an ATX power supply to this connector.

ATX 12V Connector

(4-pin ATX12V1)

(see p.8, No. 6)



Please note that it is necessary to connect a power supply with ATX 12V plug to this connector so that it can provides sufficient power. Failing to do so will cause the failure to power up.

Power LED Header

(3-pin PWR_LED1)

(see p.8 No. 19)



Please connect a 3-pin power LED cable to this header.

2.7 Serial ATA (SATA) Hard Disks Installation

This motherboard adopts VIA VT8237 southbridge chipset that supports Serial ATA (SATA) hard disks and RAID functions. You may install SATA hard disks on this motherboard for internal storage devices. This section will guide you to install the SATA hard disks.

- STEP 1: Install the SATA hard disks into the drive bays of your chassis.
- STEP 2: Connect the SATA power cable to the SATA hard disk.
- STEP 3: Connect one end of the SATA data cable to the motherboard's SATA connector.
- STEP 4: Connect the other end of the SATA data cable to the SATA hard disk.

2.8 Hot Plug and Hot Swap Functions for SATA HDDs

K7V88 motherboard supports Hot Plug and Hot Swap functions for SATA Devices.



What is Hot Plug Function?

If the SATA HDDs are NOT set for RAID configuration, it is called "Hot Plug" for the action to insert and remove the SATA HDDs while the system is still power-on and in working condition. However, please note that it cannot perform Hot Plug if the OS has been installed into the SATA HDD.

What is Hot Swap Function?

If SATA HDDs are built as RAID1 then it is called "Hot Swap" for the action to insert and remove the SATA HDDs while the system is still power-on and in working condition.

2.9 Making An SATA Driver Diskette

If you want to install Windows 2000 or Windows XP on your SATA HDDs, you will need to make an SATA driver diskette before you start the OS installation.

STEP 1: Insert the ASRock Support CD into your optical drive to boot your system. (Do NOT insert any floppy diskette into the floppy drive at this moment!)

STEP 2: During POST at the beginning of system boot-up, press <F11> key, and then a window for boot devices selection appears. Please select CD-ROM as the boot device.

STEP 3: When you see the message on the screen, "Do you want to generate Serial ATA driver diskette [Y/N]?", press <Y>.

STEP 4: Then you will see these messages,

Please insert a diskette into the floppy drive.

WARNING! Formatting the floppy diskette will lose ALL data in it!

Start to format and copy files [Y/N]?

Please insert a floppy diskette into the floppy drive, and press <Y>.

STEP 5: The system will start to format the floppy diskette and copy SATA drivers into the floppy diskette.

Once you have the SATA driver diskette ready, you may start to install Windows 2000 / Windows XP on your system directly without setting the RAID configuration on your system, or you may start to use "VT8237 SATA RAID BIOS" to set RAID 0 / RAID 1 / JBOD configuration before you install the OS. Before you start to configure the RAID function, you need to check the installation guide in the Support CD for proper configuration. Please refer to the document in the Support CD, "Guide to SATA Hard Disks Installation and RAID Configuration", which is located in the folder at the following path:

.. \ SATA RAID BIOS

You may also set the RAID configuration by using "VIA RAID Tool" in Windows environment. Please refer to the document in the Support CD, "Guide to VIA RAID Tool", which is located in the folder at the following path:

.. \ VIA RAID Tool

3. BIOS SETUP UTILITY

3.1 Introduction

This section explains how to use the BIOS SETUP UTILITY to configure your system. The Flash Memory on the motherboard stores the BIOS SETUP UTILITY. You may run the BIOS SETUP UTILITY when you start up the computer. Please press <F2> during the Power-On-Self-Test (POST) to enter the BIOS SETUP UTILITY, otherwise, POST will continue with its test routines.

If you wish to enter the BIOS SETUP UTILITY after POST, restart the system by pressing <Ctl> + <Alt> + <Delete>, or by pressing the reset button on the system chassis. You may also restart by turning the system off and then back on.



Because the BIOS software is constantly being updated, the following BIOS setup screens and descriptions are for reference purpose only, and they may not exactly match what you see on your screen.

3.1.1 BIOS Menu Bar

The top of the screen has a menu bar with the following selections:

- Main** To set up the system time/date information
- Advanced** To set up the advanced BIOS features
- H/W Monitor** To display current hardware status
- Boot** To set up the default system device to locate and load the Operating System
- Security** To set up the security features
- Exit** To exit the current screen or the BIOS SETUP UTILITY

Use <←> key or <→> key to choose among the selections on the menu bar, and then press <Enter> to get into the sub screen.

3.1.2 Navigation Keys

Please check the following table for the function description of each navigation key.

Navigation Key(s)	Function Description
← / →	Moves cursor left or right to select Screens
↑ / ↓	Moves cursor up or down to select items
+ / -	To change option for the selected items
<Enter>	To bring up the selected screen
<F1>	To display the General Help Screen
<F9>	To load optimal default values for all the settings
<F10>	To save changes and exit the BIOS SETUP UTILITY
<ESC>	To jump to the Exit Screen or exit the current screen

3.2 Main Screen

When you enter the BIOS SETUP UTILITY, the Main screen will appear and display the system overview

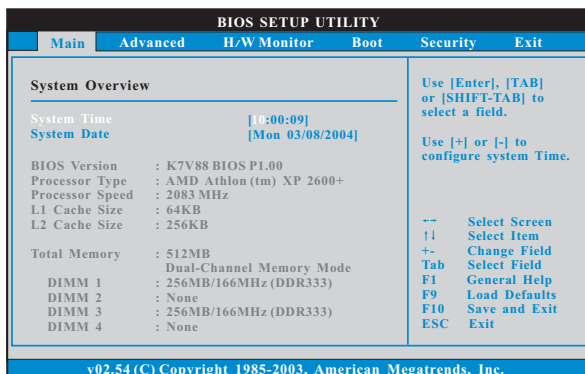

System Time [Hour:Minute:Second]

Use this item to specify the system time.

System Date [Day Month/Date/Year]

Use this item to specify the system date.

3.3 Advanced Screen

In this section, you may set the configurations for the following items: CPU Configuration, Chipset Configuration, ACPI Configuration, IDE Configuration, PCIPnP Configuration, Floppy Configuration, SuperIO Configuration, and USB Configuration.

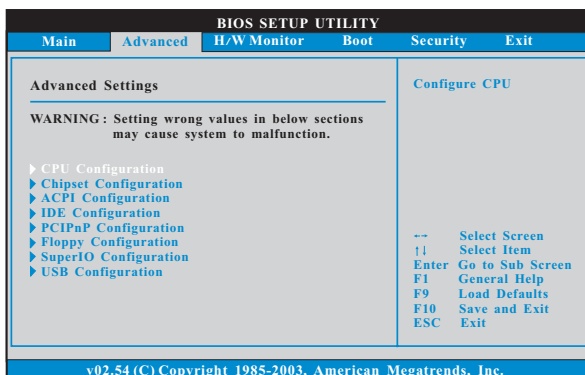

Setting wrong values in this section may cause the system to malfunction.

3.3.1 CPU Configuration

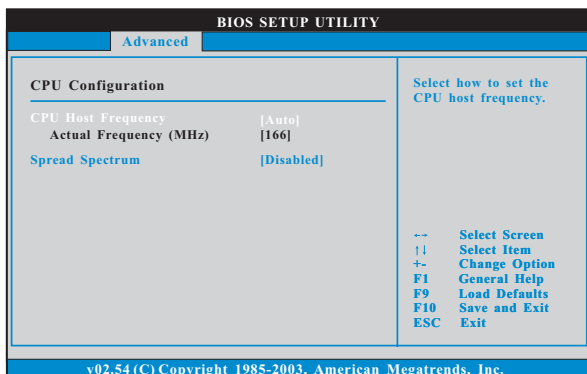

CPU Host Frequency

While entering setup, BIOS auto detects the present CPU host frequency of this motherboard. The actual CPU host frequency will show in the following item.

Spread Spectrum

This item should always be [Disabled] for better system stability.

3.3.2 Chipset Configuration

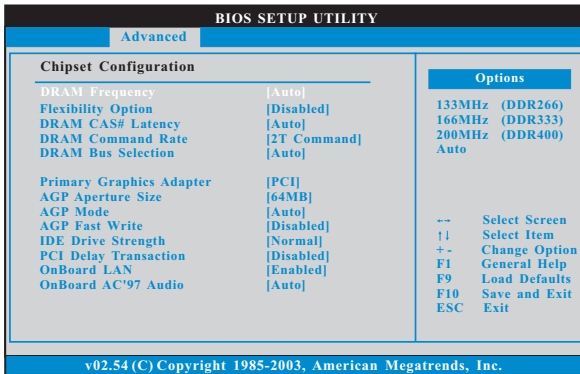

DRAM Frequency

If [Auto] is selected, the motherboard will detect the memory module(s) inserted and assigns appropriate frequency automatically. You may also select other value as operating frequency: [133MHz (DDR 266)], [166MHz (DDR 333)], [200MHz (DDR 400)].

Flexibility Option

The default value of this option is [Disabled]. It will allow better tolerance for memory compatibility when it is set to [Enabled].

DRAM CAS# Latency

Use this item to adjust the means of memory accessing. Configuration options: [Auto], [2.5], [2], and [3].

DRAM Command Rate

Use this to select among [2T Command] and [1T Command] for DRAM Command Rate. The default value is [2T Command].

DRAM Bus Selection

The default value is [Auto], which will automatically select the proper access mode for the system. You may select between [Single Channel] and [Dual Channel] if you have properly set the dual channel memory configuration.

Primary Graphics Adapter

This allows you to select [PCI] or [AGP] as the primary graphics adapter. The default value is [PCI].

AGP Aperture Size

It refers to a section of the PCI memory address range used for graphics memory. It is recommended to leave this field at the default value unless the installed AGP card's specifications requires other sizes.

AGP Mode

The default value of this feature is set to [Auto]. If you install an 8X-AGP card on this motherboard, you may select [Auto], [8X] or [4X] as the AGP mode. If the installed AGP card is a 4X-AGP card, then you may set the AGP mode as [Auto], [4X], [2X], or [1X].

AGP Fast Write

This allows you to enable or disable the feature of AGP fast write protocol support.

IDE Driving Strength

Select [Normal] or [Strong] for IDE driving strength.

PCI Delay Transaction

Enable PCI Delay Transaction feature will free the PCI Bus when the CPU is accessing 8-bit ISA cards. Disable this feature when using ISA cards that are not PCI 2.1 compliant.

OnBoard LAN

This allows you to enable or disable the onboard LAN feature.

OnBoard AC'97 Audio

Select [Auto] or [Disabled] for the onboard AC'97 Audio feature.

3.3.3 ACPI Configuration

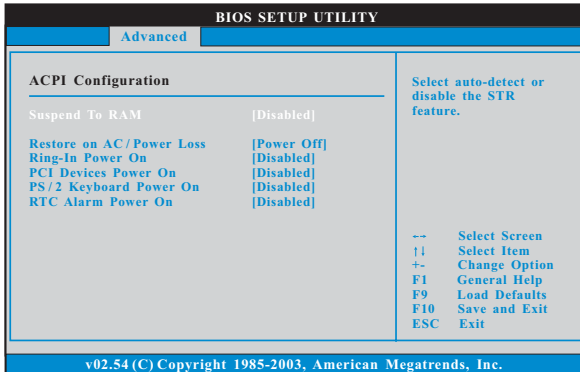

Restore on AC/Power Loss

Use this item to set the power state after an unexpected AC/power loss. If [Power Off] is selected, the AC/power remains off when the power recovers. If [Power On] is selected, the AC/power resumes and the system starts to boot up when the power recovers.

Ring-In Power On

Use this item to enable or disable Ring-In signals to turn on the system from the power-soft-off mode.

PCI Devices Power On

Use this item to enable or disable PCI devices to turn on the system from the power-soft-off mode.

PS/2 Keyboard Power On

Use this item to enable or disable PS/2 keyboard to turn on the system from the power-soft-off mode.

RTC Alarm Power On

Use this item to enable or disable RTC (Real Time Clock) to power on the system.

3.3.4 IDE Configuration

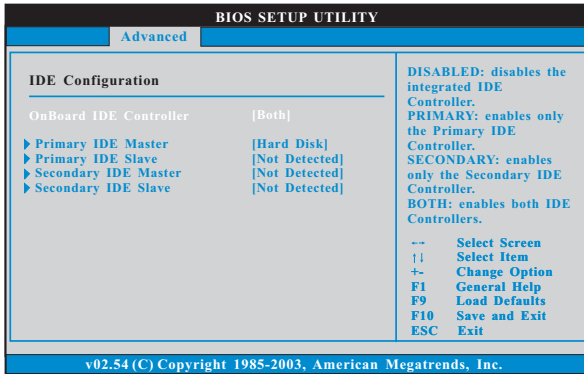

OnBoard IDE Controller

You may enable either the primary IDE channel or the secondary IDE channel. Or you may enable both the primary and the secondary IDE channels by selecting [Both]. Set to [Disabled] will disable the both. Configuration options: [Disabled], [Primary], [Secondary], [Both].

IDE Device Configuration

You may set the IDE configuration for the device that you specify. We will use the "Primary IDE Master" as the example in the following instruction, which can be applied to the configurations of "Primary IDE Slave", "Secondary IDE Master", and "Secondary IDE Slave" as well.

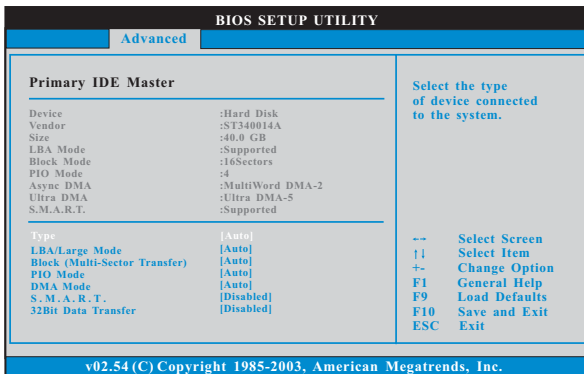

TYPE

Use this item to configure the type of the IDE device that you specify. Configuration options: [Not Installed], [Auto], [CD/DVD], and [ARMD].

[Not Installed]: Select [Not Installed] to disable the use of IDE device.

[Auto]: Select [Auto] to automatically detect the hard disk drive.



After selecting the hard disk information into BIOS, use a disk utility, such as FDISK, to partition and format the new IDE hard disk drives. This is necessary so that you can write or read data from the hard disk. Make sure to set the partition of the Primary IDE hard disk drives to active.

[CD/DVD]: This is used for IDE CD/DVD drives.

[ARMD]: This is used for IDE ARMD (ATAPI Removable Media Device), such as MO.

LBA/Large Mode

Use this item to select the LBA/Large mode for a hard disk > 512 MB under DOS and Windows; for Netware and UNIX user, select [Disabled] to disable the LBA/Large mode.

Block (Multi-Sector Transfer)

The default value of this item is [Auto]. If this feature is enabled, it will enhance hard disk performance by reading or writing more data during each transfer.

PIO Mode

Use this item to set the PIO mode to enhance hard disk performance by optimizing the hard disk timing.

DMA Mode

DMA capability allows the improved transfer-speed and data-integrity for compatible IDE devices.

S.M.A.R.T.

Use this item to enable or disable the S.M.A.R.T. (Self-Monitoring, Analysis, and Reporting Technology) feature. Configuration options: [Disabled], [Auto], [Enabled].

32-Bit Data Transfer

Use this item to enable 32-bit access to maximize the IDE hard disk data transfer rate.

3.3.5 PCIPnP Configuration

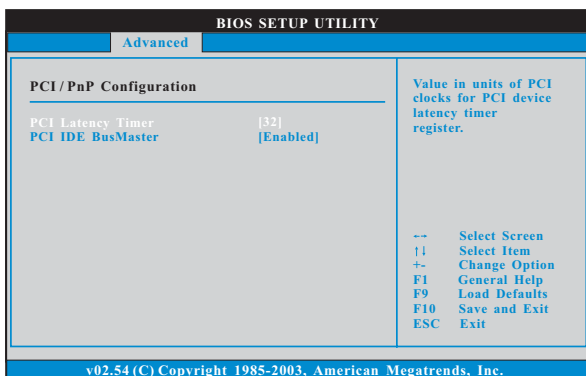

PCI Latency Timer

The default value is 32. It is recommended to keep the default value unless the installed PCI expansion cards' specifications require other settings.

PCI IDE BusMaster

Use this item to enable or disable the PCI IDE BusMaster feature.

3.3.6 Floppy Configuration

In this section, you may configure the type of your floppy drive.

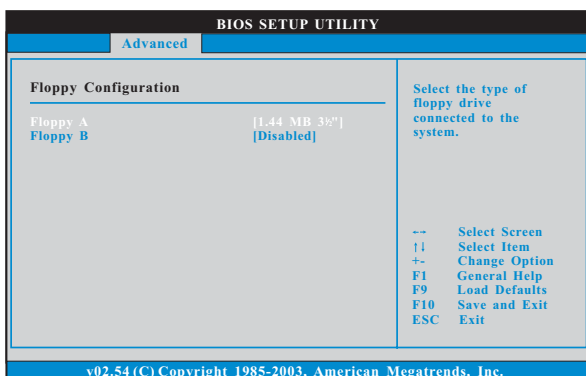

3.3.7 Super IO Configuration

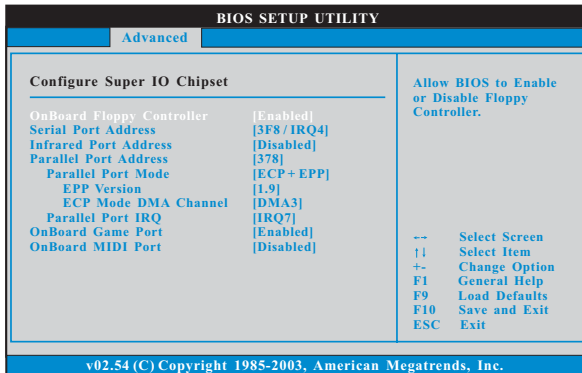

OnBoard Floppy Controller

Use this item to enable or disable floppy drive controller.

Serial Port Address

Use this item to set the address for the onboard serial port or disable it.

Configuration options: [Disabled], [3F8 / IRQ4], [2F8 / IRQ3], [3E8 / IRQ4], [2E8 / IRQ3].

Infrared Port Address

Use this item to set the address for the onboard infrared port or disable it.

Configuration options: [Disabled], [2F8 / IRQ3], and [2E8 / IRQ3].

Parallel Port Address

Use this item to set the address for the onboard parallel port or disable it.

Configuration options: [Disabled], [378], and [278].

Parallel Port Mode

Use this item to set the operation mode of the parallel port. The default value is [ECP+EPP]. If this option is set to [ECP+EPP], it will show the EPP version in the following item, "EPP Version". Configuration options: [Normal], [Bi-Directional], and [ECP+EPP].

EPP Version

Use this item to set the EPP version. Configuration options: [1.9] and [1.7].

ECP Mode DMA Channel

Use this item to set the ECP mode DMA channel. Configuration options: [DMA0], [DMA1], and [DMA3].

Parallel Port IRQ

Use this item to set the IRQ for the parallel port. Configuration options: [IRQ5] and [IRQ7].

OnBoard Game Port

Use this item to enable the Game Port or disable it.

OnBoard MIDI Port

Use this item to select the address for the MIDI Port or disable it. Configuration options: [Disabled], [300], and [330].

3.3.8 USB Configuration

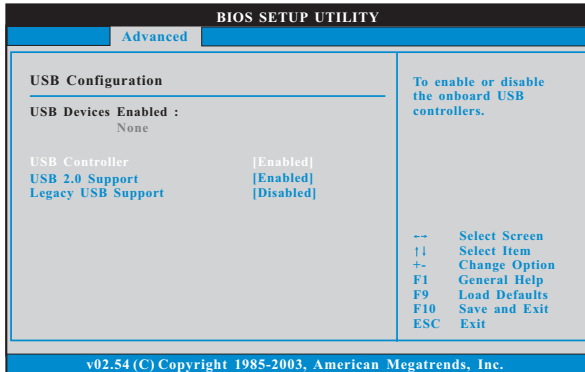

USB Controller

Use this item to enable or disable the use of USB controller.

USB 2.0 Support

Use this item to enable or disable the USB 2.0 support.

Legacy USB Support

Use this item to enable or disable the support to emulate legacy I/O devices such as mouse, keyboard,... etc. Or you may select [Auto] so that the system will start to auto-detect; if there is no USB device connected, "Auto" option will disable the legacy USB support.

3.4 Hardware Health Event Monitoring Screen

In this section, it allows you to monitor the status of the hardware on your system, including the parameters of the CPU temperature, motherboard temperature, CPU fan speed, chassis fan speed, and the critical voltage.

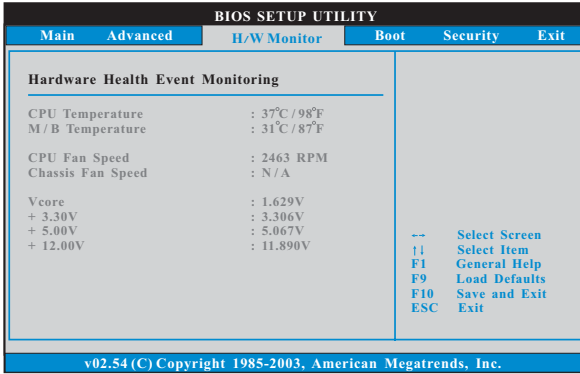

3.5 Boot Screen

In this section, it will display the available devices on your system for you to configure the boot settings and the boot priority.

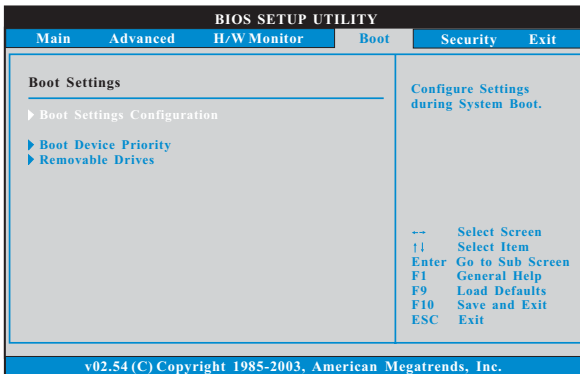

3.5.1 Boot Settings Configuration

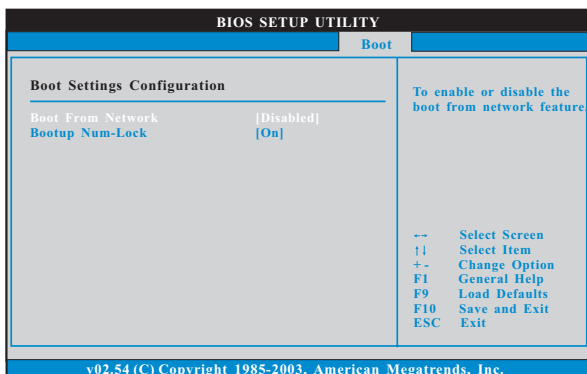

Boot From Network

Use this item to enable or disable the Boot From Network feature.

Boot Up Num-Lock

If this item is set to [On], it will automatically activate the Numeric Lock function after boot-up.

3.5.2 Boot Device Priority

In this section, you may specify the boot sequence from the available devices in your system.

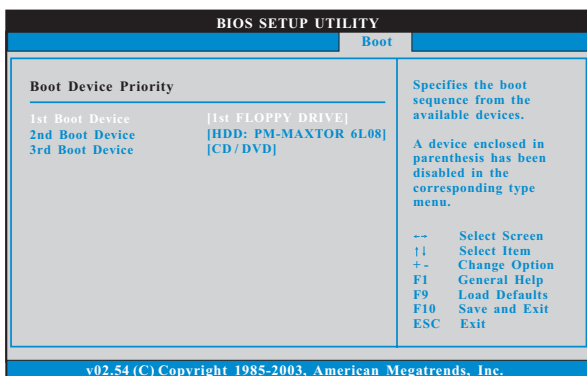

Likewise, you may also specify the boot sequence from the available devices for the hard disk drives, the removable drives, and the CD/DVD drives.

3.6 Security Screen

In this section, you may set or change the supervisor/user password for the system. For the user password, you may also clear it.

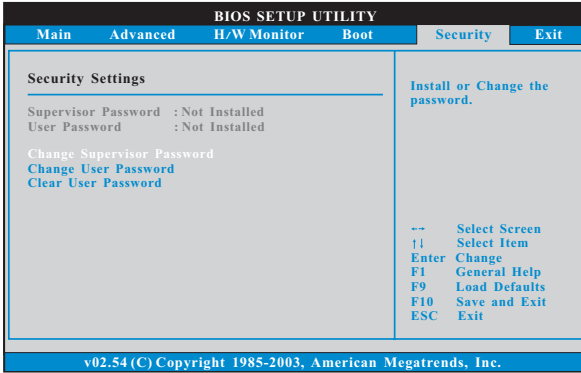

3.7 Exit Screen

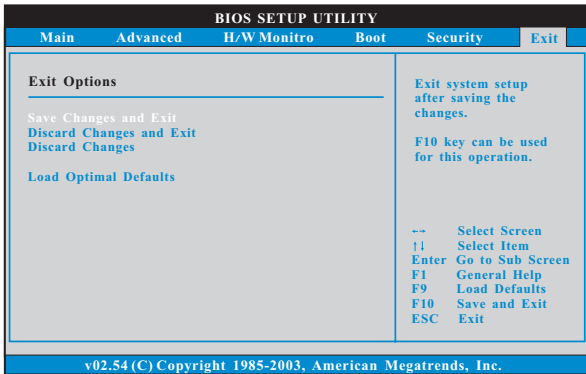

Save Changes and Exit

When you select this option, it will pop-out the following message, "Save configuration changes and exit setup?" Select [OK] to save the changes and exit the BIOS SETUP UTILITY.

Discard Changes and Exit

When you select this option, it will pop-out the following message, "Discard changes and exit setup?" Select [OK] to exit the BIOS SETUP UTILITY without saving any changes.

Discard Changes

When you select this option, it will pop-out the following message, "Discard changes?" Select [OK] to discard all changes.

Load Optimal Defaults

When you select this option, it will pop-out the following message, "Load optimal defaults?" Select [OK] to load the default values for all the setup configurations.

4. Software Support

4.1 Install Operating System

This motherboard supports various Microsoft® Windows® operating systems: 98 SE / ME / 2000 / XP. Because motherboard settings and hardware options vary, use the setup procedures in this chapter for general reference only. Refer to your OS documentation for more information.

4.2 Support CD Information

The Support CD that came with the motherboard contains necessary drivers and useful utilities that enhance the motherboard features.

4.2.1 Running The Support CD

To begin using the support CD, insert the CD into your CD-ROM drive. The CD automatically displays the Main Menu if "AUTORUN" is enabled in your computer. If the Main Menu did not appear automatically, locate and double click on the file "ASSETUP.EXE" from the BIN folder in the Support CD to display the menus.

4.2.2 Drivers Menu

The Drivers Menu shows the available devices drivers if the system detects installed devices. Please install the necessary drivers to activate the devices.

4.2.3 Utilities Menu

The Utilities Menu shows the applications software that the motherboard supports. Click on a specific item then follow the installation wizard to install it.

4.2.4 ASRock PC-DIY Live Demo Program

ASRock presents you a multimedia PC-DIY live demo, which shows you how to install your own PC system step by step. You can find the file through the following path:

..\MPEGAV\AVSEQ01.DAT

To see this demo program, you can run Microsoft® Media Player® to play the file.

4.2.5 Contact Information

If you need to contact ASRock or want to know more about ASRock, welcome to visit ASRock's website at <http://www.asrock.com>; or you may contact your dealer for further information.