

MAINBOARD

Installation Guide

Rev: 1.00H

Date: April - 99

- * All other product names are trademarks or copyrights of their respective owners.
- * Specifications and information contained in this manual are subject to change without notice.

Table of Contents

INTRODUCTION	3
Product Description	3
Features & Specifications.....	4
Package Checklist.....	5
Board Level Feature.....	6
Comprehensive Mainboard View	8
INSTALLATION.....	9
Installing the CPU	9
Setting the Jumpers.....	11
Connections.....	14
Installing the Memory Modules (DIMM)	25
Installing an AGP Card	26
Installing the Support Drivers and Utilities	27
SOFTWARE SUPPORT.....	28
Mainboard BIOS.....	28
Flash BIOS Programming Utility	29
Symbios SCSI Configuration Utility.....	30
DMI Utility.....	30

INTRODUCTION

Product Description

This mainboard represents the highest level of technology available in PC Mainboards today. Designed as a flexible, high-performance and cost-effective solution for System Integrators and End Users alike, this mainboard provides the power and expandability to meet the requirements of the most advanced operating systems and software applications.

This mainboard features “**SLOT 1**” architecture, a modular design that supports the latest Intel® Pentium® III processors (running at 450MHz ~ 700MHz with a 100MHz system bus and *for board REV2.0 or later* 533MHz ~ 733MHz on a 133MHz system bus), Pentium® II processors (running at 233MHz ~ 333MHz with a 66MHz system bus and 350MHz ~ 450MHz on a 100MHz system bus) as well as Celeron® processors. Leading edge **AGP 2X** graphic capability is provided for the full range of graphic intensive games and programs. The **ATX** form factor design allows for more efficient system assembly with built-in mouse, serial and parallel port connectors. This eliminates the need for separate ribbon cable/connector brackets and speeds the manufacturing process.

Advanced hardware designs include ACPI’s **Suspend to RAM** for the implementation of Instantly Available PCs. Also, by incorporating **Super I/O**, **Bus Mastering IDE** and **Universal Serial Bus (USB)** onto the mainboard, optimum system performance is assured and system design and implementation is simplified.

Fully “**Plug & Play**” compatible via an Award BIOS, this mainboard facilitates easy system configuration and peripheral setup. Advanced BIOS features include **Intelligent Hardware Monitoring and Alert functions**. The Award BIOS also supports **ACPI** readiness and is compatible with **PC98** specification. This mainboard is the ideal foundation for high-end computer systems.

INTRODUCTION

Features & Specifications

Processor	SLOT 1 support Intel Pentium® III, 450~700 MHz (FSB 100 MHz), 533~733 MHz (FSB 133MHz <i>for board REV2.0 or later</i>), Pentium® II processor, 233~333 MHz (FSB 66MHz), 350~450 MHz (FSB 100MHz) and Celeron® processor, 333~500 MHz
Chipset	Intel® 440BX AGPset
BIOS	Award® PCI BIOS, support ACPI, DMI, Plug-and-Play, Boot from CD-ROM, SCSI, LS-120, and ZIP devices Symbios® SCSI BIOS, Anti-virus BIOS to prevent boot virus
System Memory	3× 168-pin DIMM Sockets support up to 768MB SDRAM memory capacity Support 8/16/32/64/128/256 MB Memory Module ECC supported
On-board I/O Features	1×Floppy Port (Up to 2.88MB) 2×USB Ports 1×Parallel Port (EPP, ECP Port) 1×IrDA TX/RX Header 2×Serial Ports (16550 Fast UART Compatible) 1× Power State Header 1×MIDI/game port 1×Audio jacks: Line-out, Line-in and Mic.-In
Advanced Features	Modem Ring-in Remote Power on “Suspend to RAM” ready Wake up on LAN Keyboard Power On Hardware Monitoring function SB-link to support Sound Blaster cards for early DOS games Support X-store Bus Master IDE driver * ESS Solo1 PCI sound chip supporting software wavetable Anti-Virus PC-Cillin software *
PCI Bus Master IDE	2×UltraDMA/33 IDE Ports support UltraDMA/33: 33MB/Sec.
Expansion Slots	1× 32-bit AGP slot. 5× 32-bit PCI Bus Master slots, 2× 16-bit ISA slots
ATX Power Connector	3V, 5V and 12V 20-Pin ATX Power connector
Switching VR	Switching Voltage Regulator to support 1.3V to 3.5V
Form Factor	ATX Form factor 12" by 7.5" (305mm by 190mm)

Remark:

Suspend to RAM is a sleep state specified by the ACPI specification. It's the ideal sleep state for the Instantly Available PC. In this state over 95% of the PC's power is shut off enabling a breakthrough in power savings, and the resume time is only a few seconds.

The **XStore Pro IDE Driver** enhances memory management by working with the Windows 95/98 operating system, resulting in higher system performance by implementing "read-ahead caching after seeking". This is especially effective with the large block sizes of modern hard disks.

PC-cillin anti-virus software provides a powerful defense against viruses to protect data integration.

Package Checklist

Your mainboard package should include the items listed below. Damaged or missing items should be reported to your vendor.

- The mainboard with CPU Retention Mechanism attached
- Floppy disk ribbon cable
- IDE ribbon cable
- This Installation Guide
- BIOS, Driver & Utility Guide
- CD-ROM containing the following support software:
(The latest drivers can always be found at their respective web sites.)
 - Intel IDE Bus Master driver,
<http://support.intel.com/support/chipsets>
 - Support software for updating the FLASH BIOS
 - HighPoint® XStore Pro IDE Bus Master
<http://www.highpoint-tech.com>
 - Trend ® PC-cillin Anti-Virus software
<http://www.antivirus.com>
 - ESS Solo-1 drivers
<http://www.esstech.com>

INTRODUCTION

Board Level Feature

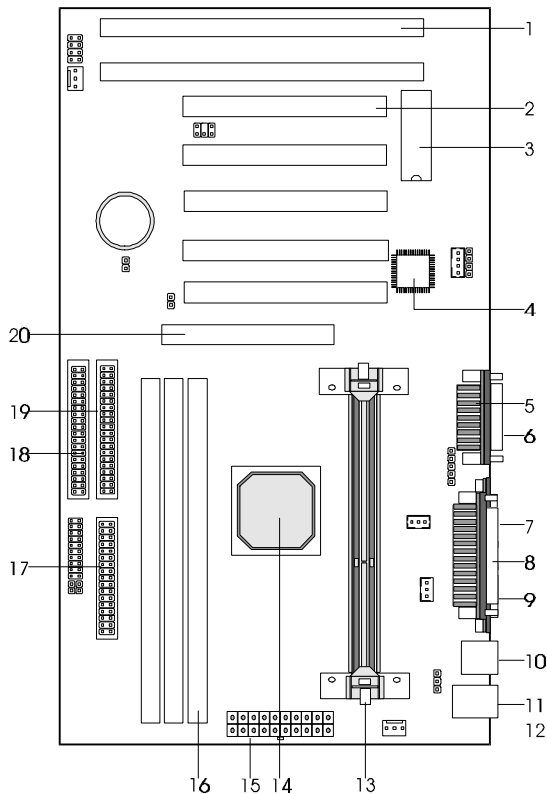

- | | |
|---------------------------|--------------------------------------|
| 1. ISA slots | 11. PS/2 mouse connector (top) |
| 2. PCI slots | 12. PS/2 keyboard connector (bottom) |
| 3. Mainboard BIOS | 13. SLOT 1 (CPU) |
| 4. Sound chip | 14. Intel® 440BX AGPset |
| 5. MIDI/Game port | 15. Power connector |
| 6. Audio port | 16. DIMM sockets |
| 7. COM2 connector | 17. Floppy connector |
| 8. Printer port connector | 18. Primary IDE connector |
| 9. COM1 connector | 19. Secondary IDE connector |
| 10. USB connectors | 20. AGP slot |

* Board Size: ATX 305 mm x 190 mm (12" x 7.5")

1. **ISA Slots:** (2) 16-bit ISA slots.
2. **PCI Slots:** (5) 32-bit PCI slots are provided.
3. **Mainboard BIOS:** Award BIOS supporting “Plug and Play”, DMI, Green PC specification, on screen setup for Enhanced IDE and Multi-I/O. The BIOS is FLASH Upgradeable via the AWDFLASH Utility.
4. **Sound Chip:** ESS PCI Sound Chip supporting software wavetable.
5. **MIDI/Game Port:** 15-pin female MIDI/Joystick connector.
6. **Audio Port:** Three 1/8” female jacks for Line Out, Line In and MIC.
7. **COM2 Connector:** High-speed UART compatible serial port. COM2 can be directed to the Infrared Module for wireless connection capability.
8. **Printer Port Connector:** EPP and ECP compatible 25-pin D-Sub parallel port.
9. **COM1 Connector:** High-speed UART compatible serial port.
10. **USB Connectors:** These connectors permit the connection of two USB peripheral devices directly to the port without an external hub. USB is a new technology supporting printers, fax modems and other telephony device.
11. **PS/2 Mouse Connector:** Supports PS/2 style mice.
12. **PS/2 Keyboard Connector:** Supports PS/2 style keyboards.
13. **SLOT 1:** Slot 1 CPU socket for Pentium[®] III, Pentium[®] II and Celeron[®] CPUs.
14. **Intel[®] 440BX AGPset:** Features PC100 SDRAM, UDMA and AGP 2x support.
15. **Power Connector:** 20-Pin ATX Power Connector.
16. **DIMM Sockets:** (3) 168-pin DIMM sockets are provided to support a maximum RAM memory capacity of 768 MB. DIMM types of 3.3 Volt true SDRAM is supported and automatically detected by the BIOS.
17. **Floppy Connector:** Built-in floppy controller supports (2) 5.25" or 3.5" (1.44MB or 2.88MB) floppy drives.
18. **Primary IDE Connector:** Connector for first IDE channel. The on-board PCI Bus Mastering IDE controller features support for DMA Mode 2 and PIO Modes 3 and 4 for faster data transfer rates. (2) Connectors are provided for support of up to (4) IDE devices on two channels. ATAPI Tape Drives and CD-ROMs are also supported.
19. **Secondary IDE Connector:** Connector for second IDE channel.
20. **AGP Slot:** AGP (Accelerated Graphics Port) is a new bus interface for high performance graphics capabilities, especially 3D.

INTRODUCTION

Comprehensive Mainboard View

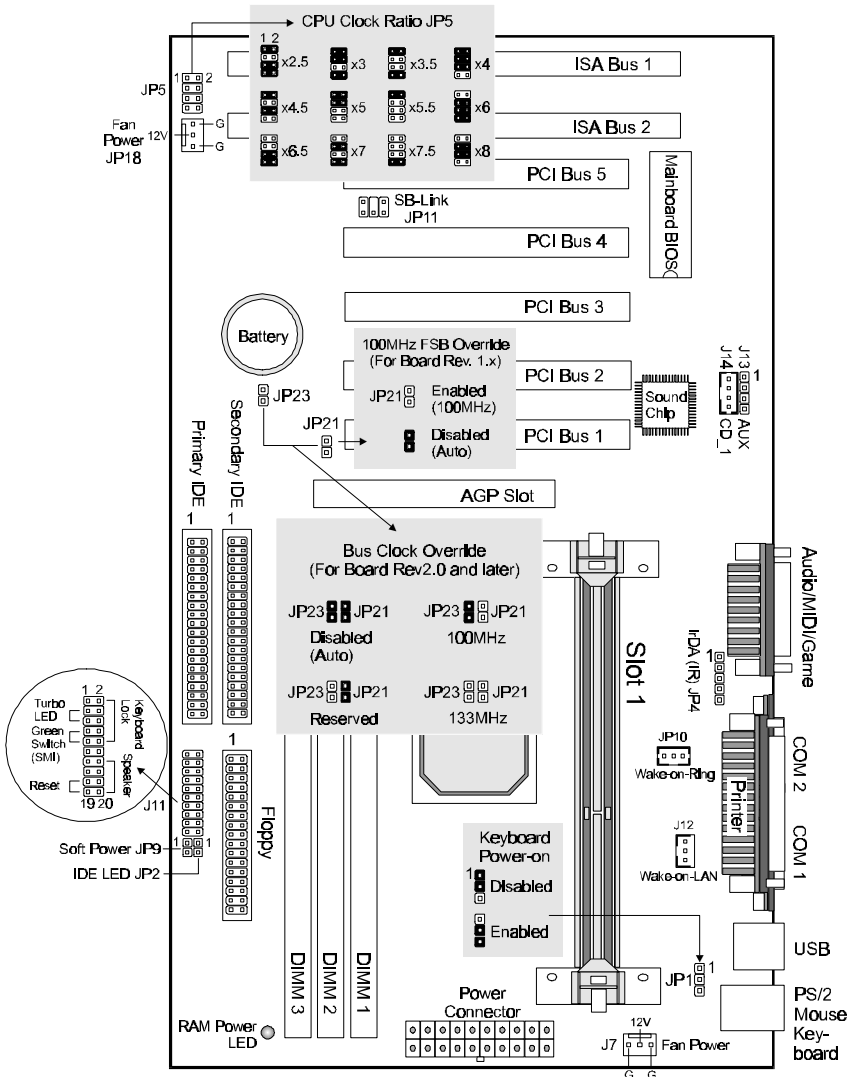

* JP23 available only for board REV2.0 or later

INSTALLATION

Static Precautions

Static electricity can be a serious danger to the electronic components on this mainboard. To avoid damage caused by electrostatic discharge, observe the following precautions:

- ✓ Don't remove the mainboard from its anti-static packaging until you are ready to install it into a computer case. Also, handle add-in cards and modules by the edges or mounting bracket.
- ✓ Before you handle the mainboard in any way, touch a grounded, anti-static surface, such as an unpainted portion of the system chassis, for a few seconds to discharge any built-up static electricity.

Installing the CPU

Your mainboard features "SLOT 1" architecture, a modular design that can accommodate the latest Intel® Pentium® III, Pentium® II and Celeron® processors.

The Central Processing Unit: CPU

Pentium® II Processor

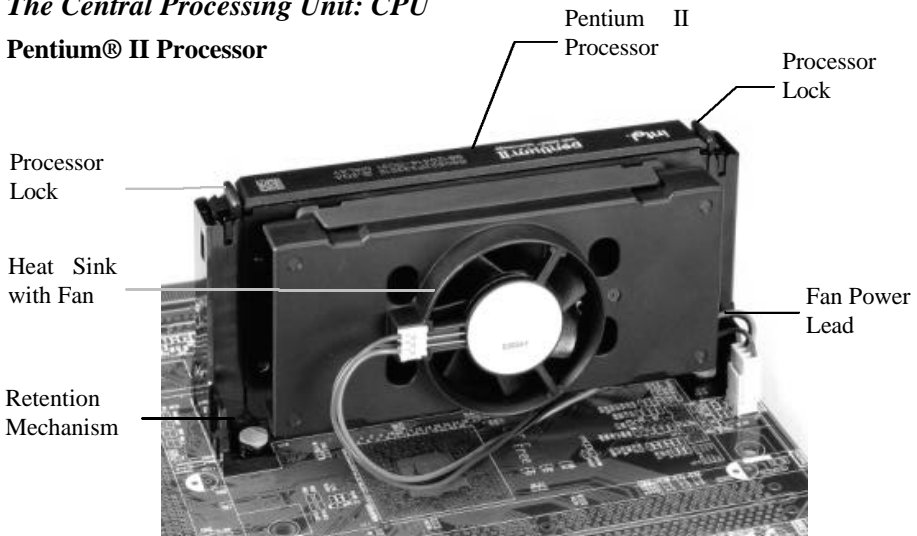

INSTALLATION

Installing the CPU

✓ **Warning:** It is required to use a CPU Cooling Fan to prevent the CPU from overheating. Install the fan first before inserting the CPU into the socket.

1. The CPU retention mechanism is already attached onboard. Before installing the CPU, simply unfold the retention mechanism to the upright position as shown below.
2. Slide the CPU down into the retention mechanism. Make sure the CPU is correctly oriented.
3. Seat the CPU firmly into the slot until the two tabs on the CPU click outwards to lock the CPU in place.

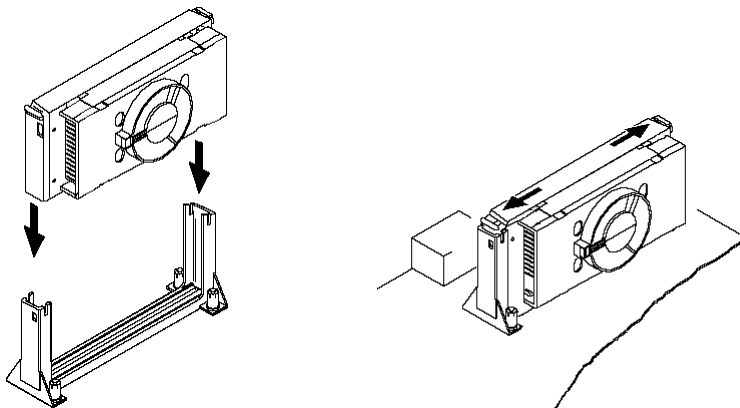

Setting the Jumpers

Jumpers are used on this mainboard to select various settings and features. A 2-pin jumper has two settings: Open and Short (or Closed). The jumper is closed by placing the Jumper Cap across the two pins, thereby connecting them. 3-pin jumpers can be set to pins 1-2 or 2-3 connected. Pin-1 is labeled on the circuit board.

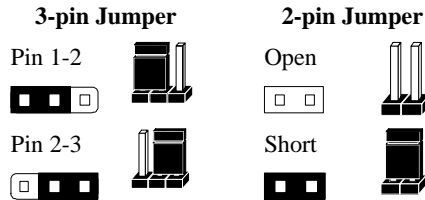

CPU Clock Selection Jumper (JP5)

After installing the CPU, you must set the clock selection jumper to match the frequency of the CPU. Find the Jumper Blocks labeled JP5 on the mainboard. Set the jumper according to the table below and the figure next page for the CPU frequency you are using.

CPU Clock	Ratio	Bus Clock
233MHz	x3.5	66MHz
266MHz	x4.0	66MHz
300MHz	x4.5	66MHz
333MHz	x5.0	66MHz
366MHz	x5.5	66MHz
350MHz	x3.5	100MHz
400MHz	x4.0	100MHz
450MHz	x4.5	100MHz
500MHz	x5.0	100MHz
550MHz	x5.5	100MHz
600MHz	x6.0	100MHz
650MHz	x6.5	100MHz
700MHz	x7.0	100MHz
533MHz	x4.0	133MHz
600MHz	x4.5	133MHz
667MHz	x5.0	133MHz
733MHz	x5.5	133MHz

- The CPU Clock corresponds to the number marked on the CPU. The Bus Clock when multiplied with the Ratio gives the CPU Clock.
- If you are uncertain about the speed requirements of your particular CPU, you should obtain Technical Documentation from the CPU manufacturer.
- New settings may be available for new CPU products.
- Such information is available via the Intel WWW site.

INSTALLATION

- The bus clock can be extended through the “*CPU Host Clock (CPU/PCI)*” option of BIOS **Chipset Features Setup** for internal test. *Over-clocking may cause serious system damage.*

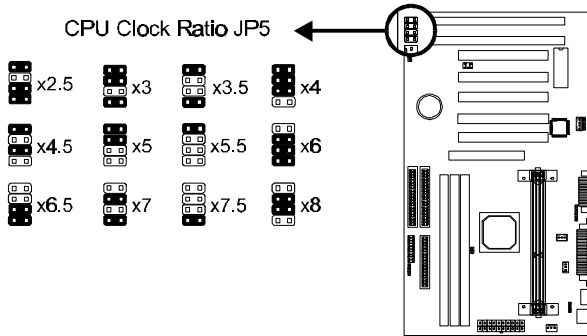

CPU Bus Clock Override Jumper (JP21 & JP23)

* *JP23 is available only for board REV2.0 or later.*

These jumpers allow you to override the CPU’s bus clock to 100MHz or 133MHz.

* Over-clocking may cause serious system damage.

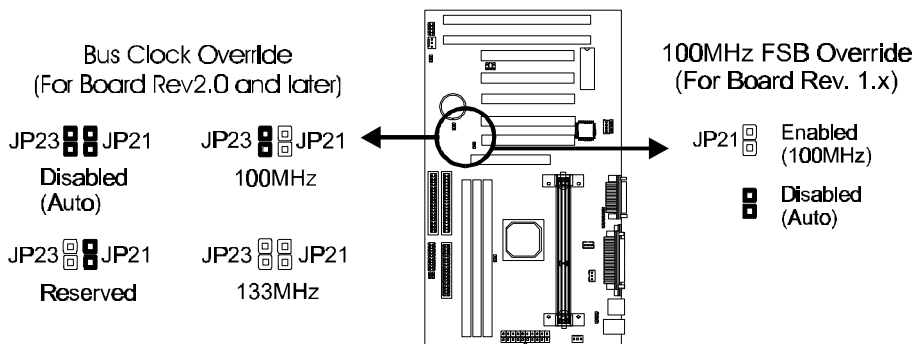

Keyboard Power-on Jumper (JP1)

This feature will power on the system from the keyboard. In addition to the jumper setting, the “***Power On Function***” in the **Integrated Peripherals Setup** of the BIOS must be set properly also.

Note: If you choose to use a password to power on the system, it is recommended to keep a written record of your password. If you forget the password, the CMOS must be cleared by removing the mainboard’s battery AND disconnecting the mainboard’s power supply for a couple of seconds then re-installing them back. This is the only way you can power on your system again.

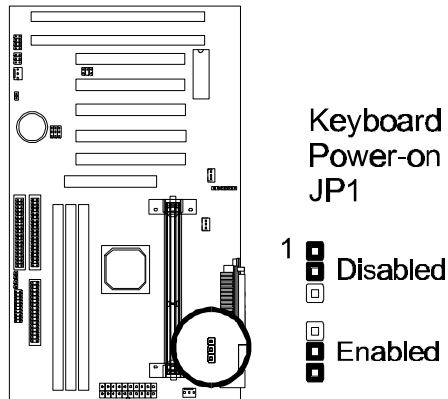

System Function Connector Block (J11)

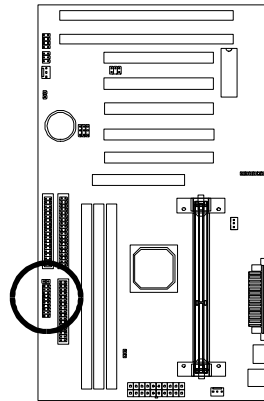
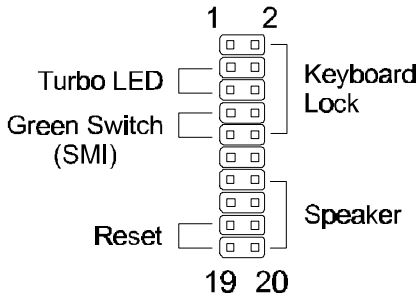

Pins [3 & 5] Turbo LED switch - The Turbo function is not supported by this mainboard. Therefore, the Turbo LED will always remain lit as long as the system power is on.

Pins [7 & 9] SMI suspend switch lead - If your system's case has a suspend switch, hook the lead from the switch to pins 7 & 9. A suspend switch is used to save electricity by putting the system into a suspend mode when the computer is not being used. This switch could also be used by the Turbo switch on the front of the system, since this mainboard does not support that function. For this switch to be functional, it must first be enabled in the Power Management Setup in the BIOS Setup utility.

Pins [17 & 19] Reset switch lead - Connects to the Reset Switch lead from the system's case. The reset switch is used to "cold-boot" the system without actually turning off the power, reducing wear and tear on the power supply.

Pins [2, 6, 8 & 10] Keyboard lock switch lead - Pins 2 & 6 connect to the power LED from the system's case. Pins 8 & 10 connect to the case-mounted keylock switch.

Pins [14 & 20] Speaker connector - Connects to the Speaker lead from the system's case.

INSTALLATION

IDE Activity LED (JP2)

Hook the IDE LED lead to this connector, with the RED lead corresponding to Pin-1.

Soft Power Switch (JP9)

Connects to the Power Switch featured on ATX case designs. This switch must be hooked up before the system can be powered on, unlike traditional “Baby-AT” designs where the power switch is located on the Power Supply itself.

Note: Under the following two conditions, you have to press and hold the switch for longer than 4 seconds to power off your system, regardless of the “**Soft-Off by PWRBTN**” setting in the BIOS.

- Shortly after the system is powered on, when the BIOS message is not yet appear.
- When CPU hangs.

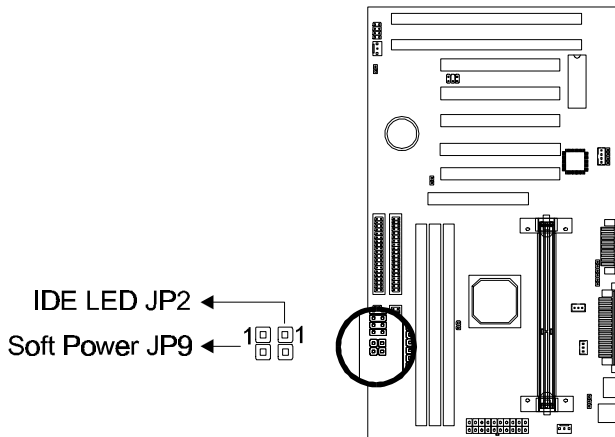

IrDA-Compliant Infrared Module Connector (JP4)

The IrDA connector bracket hooks directly to this connector on the mainboard. This connector provides support for the optional wireless transmitting and receiving infrared module. You must first configure through the BIOS setup where UART2 is directed, COM2 or IrDA.

* Pin 6 is reserved for consumer IR.

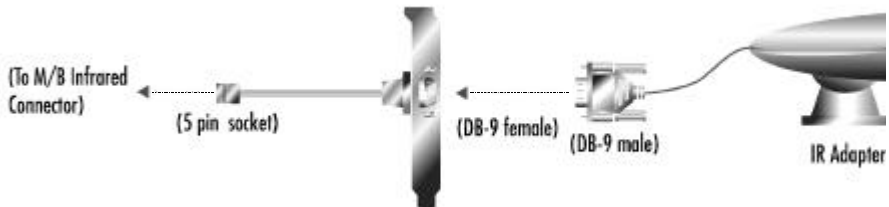
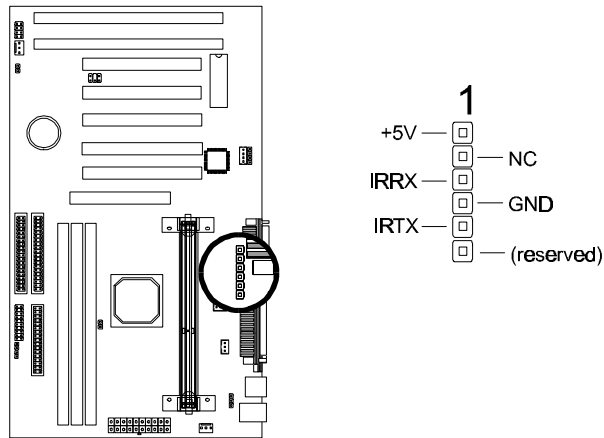

INSTALLATION

Wake-up On LAN Connector (J12)

The Wake-up On LAN function will allow the network to wake up a Soft Power Down (Soft-Off) PC. However, if your system is in the Suspend mode, you can wake-up the system only through an IRQ or DMA interrupt. To use the Wake-up On LAN function, you must enable the “Power On By Ring/LAN” field in the Power Management Setup of the Award BIOS. Connect the cable that comes with your LAN card to this connector on the system board. Refer to the add-in card’s manual for details. Note: Your LAN card must support Magic Packet in order to use the Wake-up On LAN function.

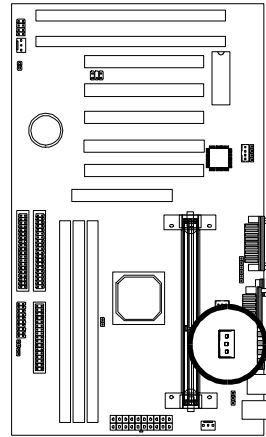

SB-Link (JP11)

Connect SB-Link cable on the Creative Sound Blaster Card to this connector. This PC to PCI bridge provides backward compatibility between PCI and ISA audio chips for earlier DOS games.

SB-Link

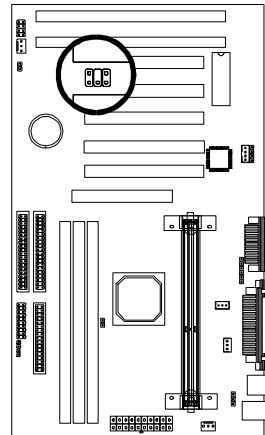
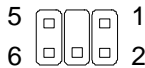

Serial and Parallel Ports

A 25-pin D-Sub header is provided on the back panel for a multi-mode bi-directional parallel port.

Two 9-pin D-Sub headers are also provided on the back panel for Serial ports.

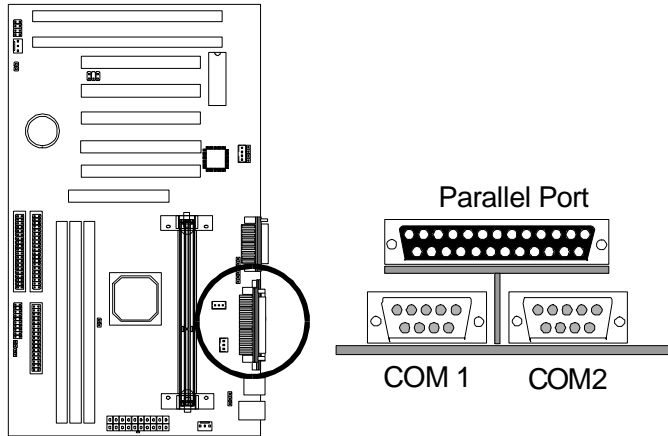

Wake-on-Ring Function

The Wake-on-Ring function allows the modem to remotely power on the system. Install an external modem (normally to COM2) and enable **Power On by Ring/LAN** function from BIOS "Power Management Setup".

For the function to work for an *internal modem card*, you must also connect the Wake-on-Ring cable on the modem card to the *Wake-on-Ring function connector (JP10)* on the mainboard.

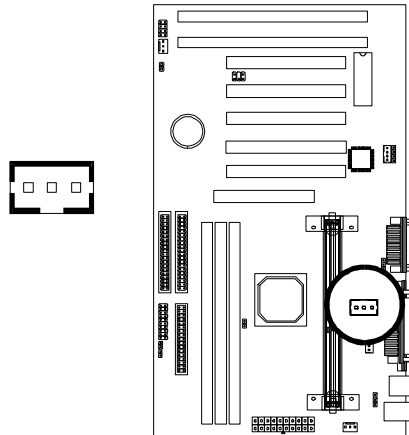

INSTALLATION

USB Connectors

These two connectors permit connection of two USB peripheral devices directly to the system without an external hub.

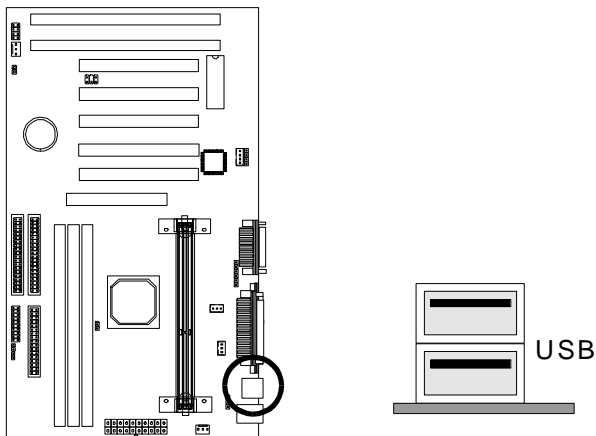

PS/2 Keyboard and Mouse Connectors

These two connectors are located on the back panel of the mainboard.

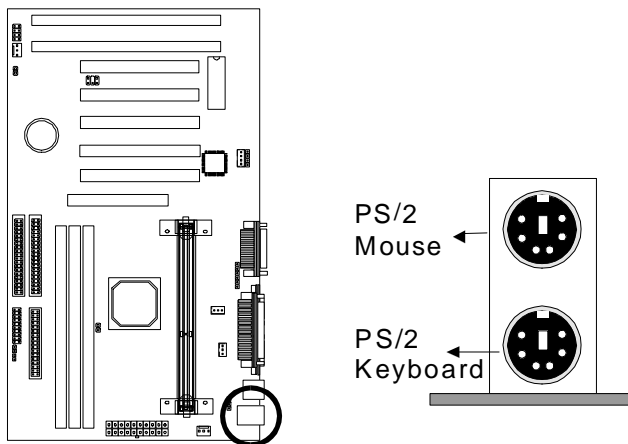

Floppy Drives

The on-board floppy controller supports (2) floppy disk drives with the floppy ribbon cable provided. Make sure the RED stripe on the ribbon cable is oriented towards Pin-1. Notice the “twist” between the sets of connectors on the floppy cable. The floppy drive “A” position is at the END of the cable, whereas floppy drive “B” is hooked to one of the connectors on the other side of the twist. The cable provides both “Edge” and “Pin” connectors for both the A and B positions to match the connector on your floppy drives.

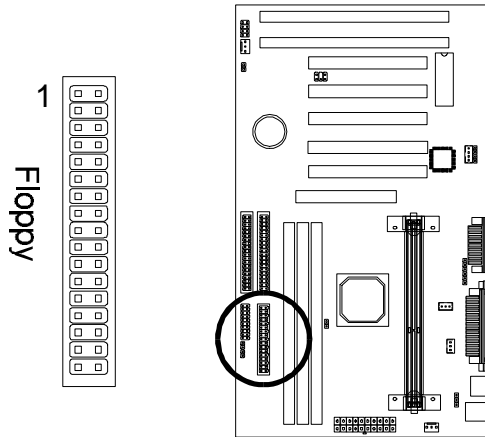

INSTALLATION

IDE Hard Drives and CD-ROMs

The on-board Enhanced IDE controller can support up to (4) IDE hard drives or other ATAPI devices, such as CD-ROMs. This controller, as with all Enhanced IDE controllers, consists of both Primary and Secondary ports. Each port has an associated connector and cable which can support up to (2) ATAPI devices each.

All IDE devices have jumpers which allow the user to configure the device as either “Master” or “Slave”. A Master device is one that is ALONE on the IDE cable, whereas a Slave device is installed as a SECOND device on the same cable. Keep in mind that the Master device will appear before the Slave device in the CMOS Setup, as well as the Operating System software. *Refer to the device documentation for jumper settings.

The Secondary IDE port can be used for up to (2) additional ATAPI devices. Normally it’s recommended that you connect your first hard drive to the Primary port, and the first CD-ROM to the Secondary.

Make sure to align the RED stripe on the ribbon cable with Pin-1 on the mainboard IDE connector. On most hard drives and CD-ROMs, the RED stripe should be oriented towards the power connector of the device.

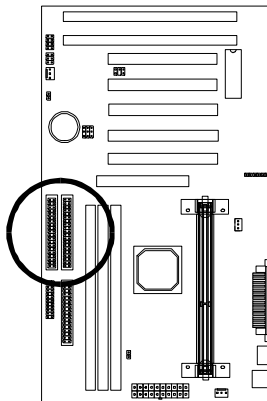
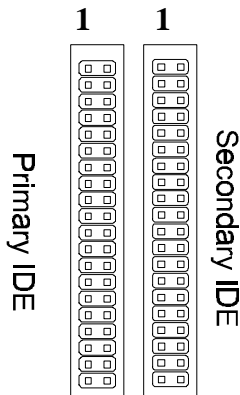

MIDI/Game Port

You may plug a joystick or game pad to this 15-pin female connector for game playing, or connect a MIDI device for playing or editing audio.

Audio Port

You can connect powered speakers or headphones to Line Out jack. Cassette players or other external audio sources can be connected to Line In jack. Plug in your microphones to MIC jack.

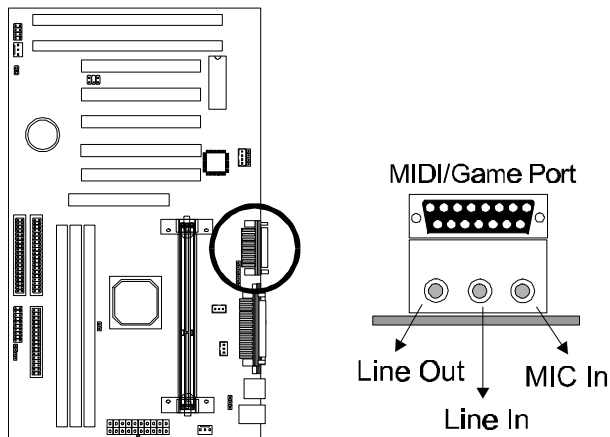

Note:

The onboard ESS Solo-1 Sound (Audio) Chip occupies **INT C** and **IRQ5**. To avoid possible conflict, any device that uses IRQ 5 or INT C must provide sharable device driver, otherwise you should re-assign the device to another IRQ#.

Also make sure that the “*Onboard Sound Chip*” option from BIOS **PNP/PCI Configuration Setup** is enabled (default).

INSTALLATION

Audio Connectors (J13 & J14)

Two types of CD Audio connectors are available for connecting the CD-ROM drive using CD audio cables.

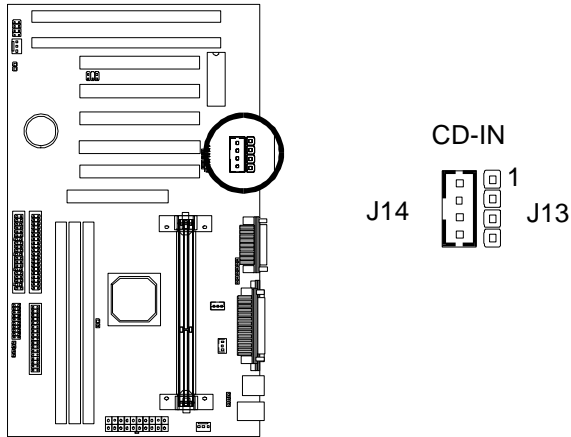

Installing the Memory Modules (DIMM)

- This mainboard has three sockets available for **168-pin DIMMs**. They must be 3.3 volt Unbuffered Synchronous DRAMs (SDRAM).
 - *To ensure reliability, it is recommended to use **PC100 SDRAM** for your 100MHz clocked SDRAM performance requirement.*
- DIMM Sizes supported: **8MB, 16MB, 32MB, 64MB, 128MB and 256MB**
- A total of **(3)** DIMMs can be installed for a maximum RAM capacity of **768MB**.

To insert the DIMMs, the modules must be oriented in the correct way. Notice the notches of the DIMM. Align these notches as shown in the diagram below. Gently push the DIMM until the retainers on both sides of the socket lock the module in place.

To remove a DIMM, push the retainers outwards to release the module then pull the module out of the socket.

Caution:

Before removing a DIMM, make sure the **RAM Power LED Indicator is off**. The blinking of the LED indicates that power is provided for the DRAM, as in normal operation as well as in Suspend to RAM mode. Removing a DIMM in the Suspend to RAM mode will result in loss of system context.

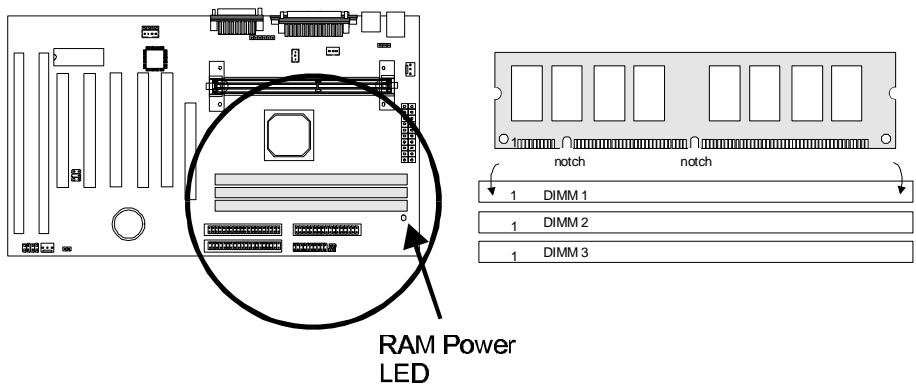

INSTALLATION

Installing an AGP Card

This mainboard provides an AGP slot to support a new generation of graphics cards with high performance graphics capability.

Note: Make sure that the AGP card is firmly seated in the AGP slot. For the card that complies with the *AGP 1.x specifications*, a slightly more force may be required to fully insert the card into the slot. For cards that comply with *AGP 2.0 and later specifications*, the installation should be relatively easy.

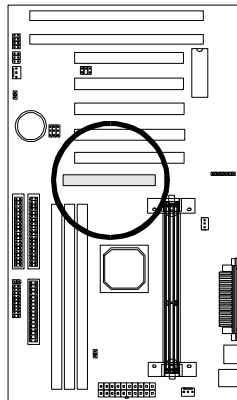

Installing the Support Drivers and Utilities

Included in your mainboard package you can find a CD-ROM containing support drivers and utilities. Just insert the CD-ROM, and from the Autorun screen, click the driver/utility that you want to install. Follow the on-screen instructions to complete the installation.



More utilities can be found under the “**Utilities**” folder of the CD-ROM.

SOFTWARE SUPPORT

For detailed information, please refer to the **BIOS, Driver & Utility Guide** included in your mainboard package.

Mainboard BIOS

Shortly after the system is powered on, provided that the system is properly setup, you will see the message:

Press DEL to enter SETUP

- Press the **DEL** key to enter the Award BIOS Setup program.

The Main Menu will appear on the screen. Use the **arrow keys** to select among the items and press **<Enter>** to accept and enter the sub-menu.

ROM PCI/ISA BIOS (xxxxxxx)
CMOS SETUP UTILITY
AWARD SOFTWARE, INC.

STANDARD CMOS SETUP	INTEGRATED PERIPHERALS
BIOS FEATURES SETUP	SUPERVISOR PASSWORD
CHIPSET FEATURES SETUP	USER PASSWORD
POWER MANAGEMENT SETUP	IDE HDD AUTO DETECTION
PNP / PCI CONFIGURATION	SAVE & EXIT SETUP
LOAD BIOS DEFAULTS	EXIT WITHOUT SAVING
LOAD SETUP DEFAULTS	
Esc : Quit	↑ ↓ → ← : Select Item
F10 : Save & Exit Setup	(Shift) F2 : Change Color

Select **LOAD SETUP DEFAULTS** for optimum system performance.

Flash BIOS Programming Utility

Since this mainboard features FLASH BIOS, the user can simply re-program the old BIOS using the AWDFLASH Utility (found under “Utilities” folder of the supplied CD-ROM) as follows:

1. First, boot the system with DOS or to “Safe Mode” under Windows 95. *This is the only correct way to run the AWDFLASH Utility program.*
2. Make sure the files “AWDFLASH.EXE” and the updated “BIN” file (which contains the actual BIOS code) are in the same directory.
3. Changing to the directory where the two required files exist, type: AWDFLASH and press [ENTER]. The AWDFLASH Utility Screen appears:

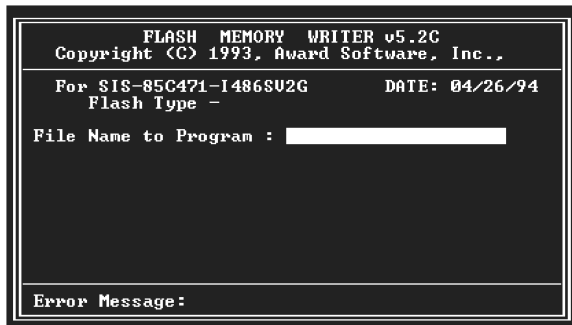

4. Type in the name of the new BIOS (.bin) file and hit [ENTER].
5. Backup the old BIOS by entering the name of the new backup file (such as “backup.bin”) and press [ENTER].
6. To begin programming, hit “y”. The Utility can be aborted at this time by hitting “n”.
7. A bar indicator will show the progress of the programming operation. After successful completion, hit the reset button or power off the computer.

Be sure to perform “**LOAD SETUP DEFAULTS**” for your new BIOS to synchronize the previous BIOS with the updated BIOS.

Symbios SCSI Configuration Utility

This mainboard features built-in Symbios SCSI BIOS. The **Symbios SCSI Configuration Utility** is a menu driven utility that allows you to view and change the default configuration settings for host adapters using Symbios 53C8XX chips.

In most cases you should not need to change the default configuration of your host adapter. You may decide to alter these default values if there is a conflict between device settings, or if you need to optimize system performance. A message appears on your computer monitor (for about 5 seconds) during boot that looks like this:

Press Ctrl-C to start Symbios Configuration Utility

If you decide to press Ctrl-C during boot, the following message appears:

Please wait, invoking Symbios Configuration Utility ...

After a brief pause, your computer will display the Main Menu of the utility.

Note: Pressing **Ctrl-A** after memory count during re-boot allows you to recover the default settings and reconfigure.

DMI Utility

This mainboard supports the **Desktop Management Interface (DMI)**, which is a new method of providing enterprise management for personal computers. The main component of DMI is the Management Information Format Database (MIF), which contains information about the computer system and its components, such as BIOS version/vendor, CPU speed/type, memory size/type, L1/L2 cache, port connectors (IDE, floppy, 2S/1P, USB, keyboard, mouse,), slots ... etc. Using DMI, remote PC management software is able to obtain various information about the system, including hardware profiles, capabilities, operational status, installation dates, and other information about the system and its components.

This DMI utility, DMICFG.EXE (found under "Utilities" folder of the supplied CD-ROM), allows you to add additional information, such as serial numbers, vendor information, and enclosure/chassis configurations, into the MIF.

FCC & DoC Compliance Statement

This device complies with Part 15 of the FCC rules, operation is subject to the following two conditions.

1. This device may not cause harmful interference and,
2. This device must accept any interference received, including interference that may cause undesired operation.

This equipment has been tested and found to comply with limits for a Class B digital device, pursuant to Part 15 of the FCC rules. These limits are designed to provide reasonable protection against harmful interference in residential installations. This equipment generates, uses, and can radiate radio frequency energy, and if not installed and used in accordance with the instructions, may cause harmful interface to radio communications. However, there is no guarantee that interference will not occur in a particular installation. If this equipment does cause interference to radio or television equipment reception, which can be determined by turning the equipment off and on, the user is encouraged to try to correct the interference by one or more of the following measures:

- Reorient or relocate the receiving antenna.
- Move the equipment away from the receiver.
- Plug the equipment into an outlet on a circuit different from that to which the receiver is connected.
- Consult the dealer or an experienced radio/television technician for additional suggestions.

The FCC requires the user to be notified that any change or modifications to the equipment by the user not expressly approved by the grantee or manufacturer could void the user's authority to operate such equipment. The use of shielded cables for connection of the monitor to the graphics card is required to assure compliance with FCC regulations.

