Twister AT Pentium *System Board Manual*

MICRONICS

Document Number: 06-00317-01, Rev. 1B

April 1997

45365 Northport Loop West, Fremont, CA 94538-6417

Copyright Notices

Copyright © 1997 Micronics Computers, Inc. The information contained in the Twister AT PCI/ISA Pentium Processor system board manual has been carefully checked and is believed to be accurate. Micronics assumes no responsibility for any inaccuracies that may be contained in this document. Micronics makes no commitments to update or to keep the information in this manual at a current level when changes are made to the product.

Micronics reserves the right to make improvements to this document and/or product at any time and without notice. All Rights Reserved. No part of this document may be photocopied, reproduced, translated, or reduced to any medium or machine form without prior, written consent from Micronics.

Portions of the Manual

Portions of this manual were copied (with permission) from Award Software Inc. All rights reserved.

Trademarks

Award Modular BIOS is a registered trademark of Award Software Inc. IBM is a registered trademark of International Business Machines. Microsoft and Windows are registered trademarks of Microsoft Corporation. Intel and PCI are registered trademarks of Intel Corporation. All other product names mentioned herein are used for identification purposes only and may be the trademarks of their respective companies.

Table of Contents

Introduction	5
Features	6
Software Compatibility	7
Before You Begin	8
Chapter 1 - Quick Installation	9
Installing the Twister AT	9
Chapter 2 - Configuring the Twister AT	13
Static Electricity	13
Office Environment	13
Twister AT System Board	14
Jumper Settings	15
Chapter 3 - Installing the Twister AT	19
Introduction	19
System Memory Support	19
Installing the Twister AT	20
Tools Required	20
Equipment Required	20
System Memory	21
Adding Memory	21
Memory Usage	22
Memory Configurations	24
Installing a CPU	28
Installing the DIMMs	29
Removing DIMMs	29
Installing the SIMMs	30
Removing SIMMs	30

Installing a PCI Peripheral Card	31
Installing an ISA Peripheral Card	32

Chapter 4 - The BIOS Setup Utility	33
---	----

Configuration	33
Initial Bootup	33
Setup	33
Running the Setup Procedure	35
Standard CMOS Setup	36
BIOS Features Setup	38
Chipset Features Setup	41
Power Management Setup	45
PnP/PCI Configuration Setup	48
Load BIOS Defaults	50
Load Setup Defaults	50
Integrated Peripherals	51
Supervisor Password	54
User Password	54
IDE HDD Auto Detection	55
HDD Low Level Format	56
Save and Exit Setup	57
Exit Without Saving	57

Appendix A - Technical Information	59
---	----

Specifications	59
Environmental Specifications	60
Temperature Range	60
Relative Humidity	60
Battery Disposal	61
Support and Information Services	62
Technical Support	62
Online Services	63

Appendix B - Post Messages	65
Appendix C - Updating the System BIOS	69
Appendix D - Warranties and Notices	71
Limited Warranty	71
Non Warranty Service	72
FCC Statement	73
Glossary	74
Index	78

List of Figures

Figure 1.1: Power-Up Screen	10
Figure 2.1: Twister AT System Board	14
Figure 3.1: Installing a 168-Pin DIMM	29
Figure 3.2: Installing a 72-Pin SIMM	30
Figure 3.3: Installing a PCI Peripheral Card	31
Figure 3.4: Installing an ISA Peripheral Card	32
Figure 4.1: Power-Up Screen	34
Figure 4.2: Main CMOS Setup Screen	35
Figure 4.3: Standard CMOS Setup Screen	36
Figure 4.4: BIOS Features Setup Screen	38
Figure 4.5: Chipset Features Setup Screen	41
Figure 4.6: Power Management Screen	45
Figure 4.7: PnP/PCI Configuration Screen	48
Figure 4.8: Integrated Peripherals Screen	51
Figure 4.9: IDE HDD Auto Detection Screen	55
Figure 4.10: HDD Low Level Format Screen	56

List of Tables

Table 2.1: System Speed Selection (Intel)	15
Table 2.2: System Speed Selection (Cyrrix)	15
Table 2.3: System Speed Selection (AMD)	16
Table 2.4: Clear CMOS Memory Selection	16
Table 2.5: Power Supply Voltage Selection	17
Table 2.6: Flash System BIOS Selection	17
Table 2.7: Connector Settings and Functions	18
Table 3.1: Memory Configurations (SIMMs Only)	24
Table 3.2: Memory Configuration (SIMMs Only)	25
Table 3.3: Memory Configuration (DIMMs Only)	26
Table 3.4: Memory Configuration (SIMMs & DIMMs)	27
Table A.1: Support and Information Services	63

Introduction

Thank you for choosing the Twister AT system board. The Twister AT is a high-performance Pentium processor solution for desktop systems. Based on the Intel 430TX PCIset, the Twister AT provides enhanced PCI throughput and performance for today's demanding applications. The integrated voltage regulator module permits compatibility with processors from Intel, Cyrix and AMD.

Other features of the 430TX PCIset include Advanced Power Management, Universal Serial Bus support (USB), Ultra DMA/33 IDE hard drive protocol (up to 33MBytes/sec transfer rate), concurrent PCI and support for different memory types, including Synchronous Dynamic RAM (SDRAM) and Extended Data Out RAM (EDO RAM).

The USB interface has a maximum bandwidth of 12Mbps and can connect as many as 127 devices to a host system. USB supports both standard devices that operate at the full 12Mbps rate and low-end devices that use only a 1.5Mbps subchannel.

Micronics builds all products to exacting standards, using the highest quality components available. We are proud to provide this system board and believe you will be pleased with your purchase.

Features

The Twister AT includes the following features:

- ▲ Single ZIF socket 7
 - Intel Pentium® 75-200MHZ
 - Intel Pentium® 166-233MHz Processors with MMX®
 - Intel Pentium® Overdrive (P54CTB)
 - Cyrix™ 6x86
 - AMD-K5™ and AMD-K6™
 - Integrated Voltage Regulator Module
- ▲ Intel 430TX PCI chipset
 - Intel PIIX 4
 - SMC FDC37C66x Ultra I/O chip
- ▲ 256K or 512K Pipelined Burst Level 2 Cache soldered onboard.
- ▲ Five 32-bit PCI slots
 - Four 16-bit ISA slots
 - (One is a shared PCI/ISA slot)
- ▲ Maximum memory - 256MB
 - Two 3.3V unbuffered 64-bit 168-pin DIMM sockets
 - Four 32-bit 72-pin SIMM sockets
 - Supports FPM, EDO and SDRAM memory
- ▲ Two Universal Serial Bus (USB) ports (via cable) for desktop peripheral expansion.
- ▲ Ultra DMA/33 IDE
- ▲ Baby AT form factor

Software Compatibility

The Twister AT system board has been thoroughly tested for compatibility with a variety of operating systems and environments, including:

- ▲ Microsoft
 - DOS 5.0
 - DOS 6.2
 - Windows 95
 - Windows NT 3.51
 - Windows NT 4.0
- ▲ IBM
 - OS/2 Warp 3.0
 - OS/2 Warp 4.0
- ▲ SCO
 - UNIXWare 2.1.1
 - Open Server 5.02
 - UNIX 3.2, 4.2
- ▲ Novell NetWare 3.12
 - Novell NetWare 4.11

Before You Begin

This manual will familiarize you with the features, installation and use of your Twister AT. There are several symbols and conventions used throughout this manual to help draw your attention to a feature or to focus on important information:



When you see the Magnifying Glass, it refers to something you should take a closer look at before proceeding further.



When you see the Exclamation Mark, it gives important information on avoiding damage.

Common Names

APM	Automatic Power Management
DIMM	Dual Inline Memory Module
DRAM	Dynamic Random Access Memory
EDO	Extended Data Out
FPM	Fast Page Mode
IDE	Integrated Drive Electronics
PCI	Peripheral Component Interconnect
SDRAM	Synchronous DRAM
SIMM	Single Inline Memory Module
USB	Universal Serial Bus
VRM	Voltage Regulator Module

Quick Installation

We know that many experienced people prefer to read as little of the documentation as possible. If this sounds like you, here's the short form to get up and running quickly.

Installing the Twister AT

1. Make backup copies of your installation and configuration diskettes.
2. Ground yourself to prevent damaging static discharge by using an anti-static wrist or ankle strap, or touch a safely grounded metal object.
3. Remove the Twister AT from its packaging.
4. Configure and verify the system board's jumper settings (refer to Jumper Settings in Chapter 2).
5. Install the CPU and the system memory.
6. Install the system board in the chassis and make all necessary case connections.
7. Install any ISA and/or PCI add-on peripherals.
8. Connect any optional devices.
9. Turn the computer on and press the key when you see the screen shown in Figure 1.1.

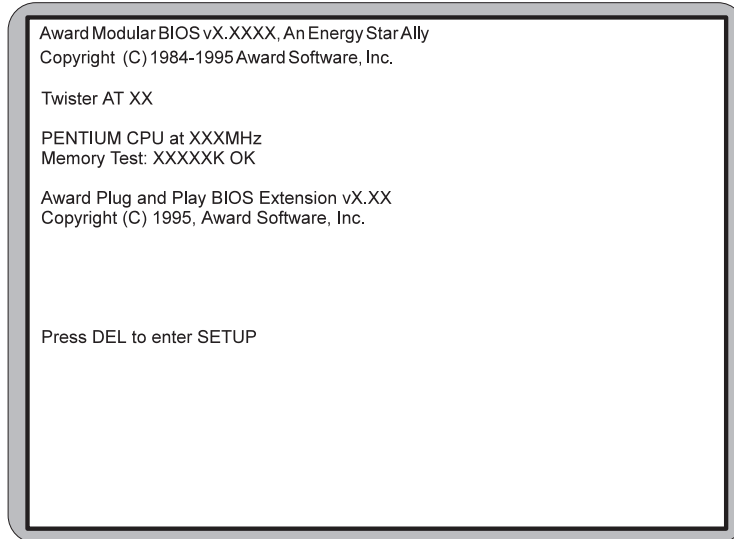

Figure 1.1: Power-Up Screen

10. If necessary, use the arrow keys to move the highlight to STANDARD CMOS SETUP and press <Enter>.
11. Set the time and date.
12. If necessary, adjust the settings for the floppy drive(s) and hard drive(s) to match your configuration. If you are installing one or more IDE drives, the BIOS automatically configures your drive(s) for you when the setting in the Type column is Auto. See Chapter 4 for additional information and additional instructions.
13. Verify that the floppy drive type(s) shown for Drive A (and Drive B, if installed) are correct. If necessary change the setting(s) for the floppy drive(s) using the <Pg Up> and/or <Pg Dn> keys or the <+> and <-> keys.
14. Verify that the amounts of memory shown in the Standard CMOS Setup screen correctly reflect the amount of RAM installed in your system.

15. Press <ESC> to return to the main setup menu.
16. Use the arrow keys to move the highlight to any of the other setup options in the main menu that contain settings you want to review or change (for information on the various setup options in the main menu, see Chapter 4). When you are finished, press <F10> to select Save & Exit Setup. You are now finished with the BIOS configuration.

Configuring the Twister AT

Although the Twister AT system board is packaged in materials that are designed to protect it from physical damage and static electricity, it is important to use care while unpacking the board and setting it up.

Static Electricity

The Twister AT is shipped from the factory in an anti-static bag. To reduce the possibility of damage from static discharge, it is important to neutralize any static charges your body may have accumulated before handling the board.

The best way to do this is to ground yourself using a special anti-static wrist or ankle strap. If you do not have an anti-static strap available, touch both of your hands to a safely grounded object, such as the power supply or chassis of a computer that is connected to the power socket. After you have grounded yourself, ground the Twister AT board via one of the solder pads that surround its mounting holes. When you remove the Twister AT from its packaging, place it on top of the anti-static bag, and carefully inspect the board for damage which might have occurred during shipment.

Environment Considerations

Make sure the finished computer system is in an area with good ventilation. The system should not be in direct sunlight, near heaters, or exposed to moisture, dust, or dirt.

Twister AT System Board

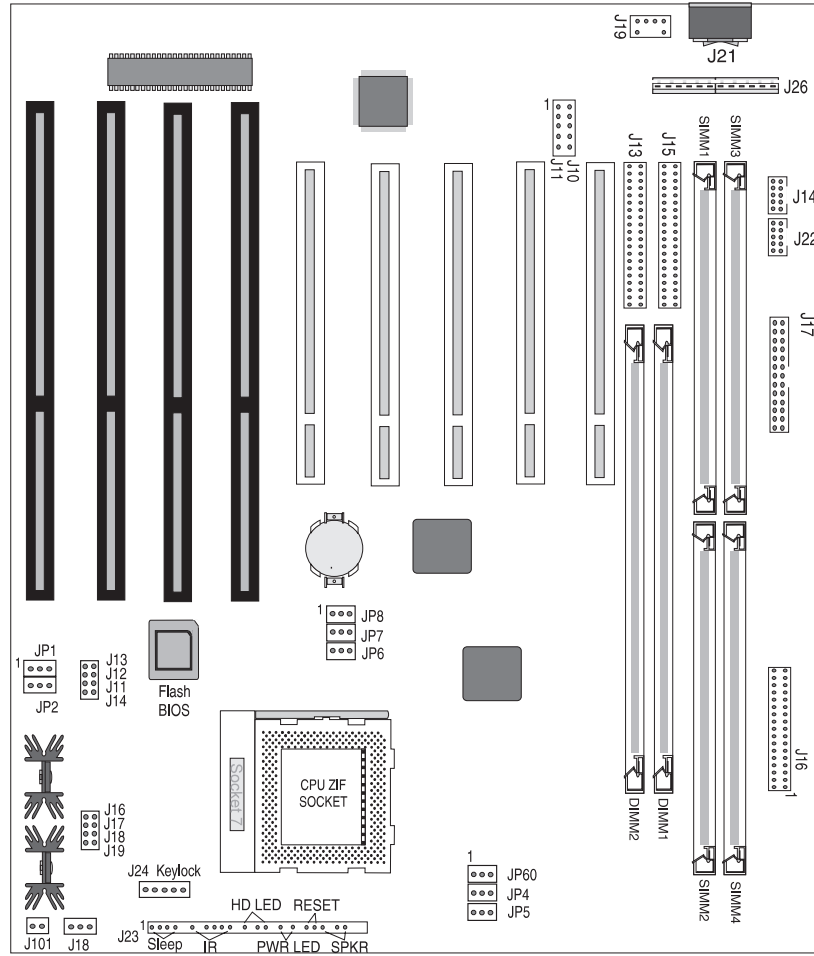

Figure 2-1. Twister AT System Board Diagram

Jumper Settings

This section provides the jumper settings for the Twister AT system board.

Table 2-1 lists the system speed settings for the Intel Processors.

CPU Speed (Intel)	CPU External Bus Speed			CPU Frequency Ratio		
	JP6	JP7	JP8	JP60	JP4	JP5
75MHz (50 x 1.5)	2-3	2-3	2-3	-	1-2	1-2
90MHz (60 x 1.5)	2-3	2-3	1-2	-	1-2	1-2
100MHz (66 x 1.5)	2-3	1-2	2-3	-	1-2	1-2
120MHz (60 x 2.0)	2-3	2-3	1-2	-	1-2	2-3
133MHz (66 x 2.0)	2-3	1-2	2-3	-	1-2	2-3
150MHz (60 x 2.5)	2-3	2-3	1-2	-	2-3	2-3
166MHz (66 x 2.5)*	2-3	1-2	2-3	-	2-3	2-3
180MHz (60 x 3.0)	2-3	2-3	1-2	-	2-3	1-2
200MHz (66 x 3.0)	2-3	1-2	2-3	-	2-3	1-2
233MHz (66 x 3.5)	2-3	1-2	2-3	-	1-2	1-2

Table 2-1: System Speed Selection (Intel)

Table 2-2 lists the system speed settings for the Cyrix Processors.

CPU Speed (Cyrix)	CPU External Bus Speed			CPU Frequency Ratio		
	JP6	JP7	JP8	JP60	JP4	JP5
Cyrix PR150+ 120MHz (60 x 2.0)	2-3	2-3	1-2	-	1-2	2-3
Cyrix PR166+ 133MHz (66 x 2.0)	2-3	1-2	2-3	-	1-2	2-3

Table 2-2: System Speed Selection (Cyrix)

* Default Setting
- Open

Chapter 2: Configuring the Twister AT

Table 2-3 lists the system speed settings for the AMD Processors.

CPU Speed (AMD)	CPU External Bus Speed			CPU Frequency Ratio		
	JP6	JP7	JP8	JP60	JP4	JP5
AMD-K5-PR75 75MHz (50 x 1.5)	2-3	2-3	2-3	-	1-2	1-2
AMD-K5-PR90 90MHz (60 x 1.5)	2-3	2-3	1-2	-	1-2	1-2
AMD-K5-PR100 100MHz (66 x 1.5)	2-3	1-2	2-3	-	1-2	1-2
AMD-K5-PR120 90MHz (60 x 1.5)	2-3	2-3	1-2	-	1-2	1-2
AMD-K5-PR133 133MHz (66 x 2.0)	2-3	1-2	2-3	-	1-2	2-3
AMD-K5-PR166 166MHz (66 x 2.5)	2-3	1-2	2-3	-	2-3	2-3
AMD-K6-PR166 166MHz (66 x 2.5)	2-3	1-2	2-3	-	2-3	2-3
AMD-K6-PR200 200MHz (66 x 3.0)	2-3	1-2	2-3	-	2-3	1-2
AMD-K6-PR233 233MHz (66 x3.5)	2-3	1-2	2-3	1-2	1-2	1-2

Table 2-3: System Speed Selection (AMD)

Table 2-4 lists the settings to clear the CMOS settings. With your computer's power off, close pins 2-3, wait ten seconds and place the jumper back on pins 1-2. (The jumper must be placed back on pins 1-2 for the system to function properly.)

NOTE: This will reset all BIOS default settings. Any changes you have made will be lost.

Jumper	Function	Settings
JP1	Normal	1-2
	Clear CMOS	2-3

Table 2.4: Clear CMOS Settings

Chapter 2: Configuring the Twister AT

Table 2-5 lists the available processor supply voltages and the corresponding jumper settings that select them.

CPU Type	Jumper Settings							
	JP16	JP17	JP18	JP15	JP13	JP12	JP11	JP14
Intel P54C/CS/CTB/ Cyrix 6x86	-	Close	-	-	-	Close	-	-
Intel P55C MMX/ Cyrix 6x86L	-	Close	-	-	-	-	-	Close
AMD K5	-	Close	-	-	Close	-	-	-
AMD K6-166/200	-	Close	-	-	-	-	-	Close
AMD K6-233	-	Close	-	-	-	-	Close	-

Table 2-5: Power Supply Voltage Selection

Table 2-6 lists the jumper setting to flash the system BIOS.

Jumper	Function	Settings
JP2	Reserved	1-2
	Normal	2-3

Table 2-6: Flash BIOS Selection

- Open

Chapter 2: Configuring the Twister AT

Table 2-7 lists all of the connectors and their functions.

Connector	Function	Notes
J10	USB Connector	Port 0
J11	USB Connector	Port 1
J13	Secondary IDE Port	Can be disabled at the CMOS configuration screen
J14	Serial Port (COM 2)	Can be disabled at the CMOS configuration screen
J15	Primary IDE Port	Can be disabled at the CMOS configuration screen
J16	Floppy Drive Connector	
J17	Parallel Port Connector	Can be disabled at the CMOS configuration screen
J18	CPU Fan	1 - +12V Power; 2 - Ground
J19 & J21	PS/2 Keyboard & Mouse Connector	
J22	Serial Port (COM 1)	Can be disabled at the CMOS configuration screen
J23	Sleep Switch	3 - Sleep_REQ; 4 - FPSleep_Pwr
"	Infrared (IR)	6 - +5V; 7 - Key; 8 - Receive Data; 9 - Ground; 10 - Transmit Data; 11 - No connect
"	HDD LED	13 - +5V; 14 - Key; 15 - HDD Active; 16 - +5V
"	Power LED	18 - Ground; 19 - Key; 20 - Power_DRV
"	Reset Switch	22 - Ground; 23 - FP_Reset
"	Speaker	24 - +5V; 25 - Key; 26 - Speaker Data Connect; 27 - PC Speaker Output
J24	Keylock Switch	1 - Power; 2 - No Connect; 3 - Ground; 4 - Keyboard Lock; 5 - Ground
J26	AT Power Connector	
J100	SCSI LED	1 - NC; 2 - SCSI Active LED In

Table 2-7: Connector Settings and Functions

Installing the Twister AT

Introduction

This section explains how to install the Twister AT system board, memory, CPU and peripherals.

WARNING: *Before installing or removing any peripherals or components, make sure you have a clear work space and that you adhere to all anti-static precautions described in Chapter 1. Micronics recommends that only trained technicians install and configure the system board.*

Damage which occurs to the board while adding or removing peripherals or components may void the warranty. If problems arise while installing peripherals, contact the computer dealer where you purchased the peripheral or Micronics' Technical Support Department.

System Memory Support

The flexibility of the Twister AT is augmented by its support for SDRAM, EDO and FPM DRAM memory. SDRAM memory is a new, faster memory technology that features the ability to synchronize all operations with the processor clock signal, which enables the coexistence of high-performance and simple user interface.

The SDRAM memory technology extends the performance of conventional DRAM memory with its synchronized operation and burst mode. The result is an improvement in memory-access performance on the Twister AT system board.

Installing the Twister AT

Installation of the Twister AT system board depends on the type of case you use. The Twister AT is designed for the Baby AT form factor and may be installed into most cases.

NOTE: If you are unfamiliar with installing a system board, Micronics highly recommends that you read the computer user's manual or contact your dealer's technical support department.

Tools Required

Micronics recommends using the following tools to install the Twister AT:

- Small Phillips screwdriver
- Tweezers or a pair of needle-nose pliers
- Tray (to hold loose screws)

Equipment Required

Micronics recommends using the following equipment with the Twister AT for a typical configuration:

- AT chassis with standard hardware.
- A high-quality AT power supply capable of providing continuous power within a 5 volt range. A power filter may be used with a noisy AC power source.
- AT style keyboard and PS/2 mouse connector via cable.
- Eight ohm speaker (standard in most cases).
- Standard ribbon cables for internal connections.
- Standard power cord (grounded).
- Heat sink with cooling fan for CPU (required for all Pentium class processors).

System Memory

System memory is necessary to operate the Twister AT system board. The Twister AT supports DIMM modules and/or SIMM modules for a maximum of 256MB of memory. There are two 168-pin 3.3V unbuffered DIMM sockets. Each DIMM socket provides a 64-bit wide data path. There are four 72-pin SIMM sockets. Each SIMM socket provides a 32-bit wide data path.

Support is provided for EDO, SDRAM and FPM DRAM memory. This section lists the rules for adding memory to the Twister AT, gives some examples of common memory configurations and shows how to physically install the memory.

Adding Memory

The following is a list of rules to follow when installing DIMMs and SIMMs. If you follow these rules, your upgrade should be trouble-free:

- ❑ Use 70ns or faster DIMMs and SIMMs.
NOTE: For long term reliability, Micronics recommends using DIMMs with gold-plated contacts and SIMMs with tin-plated contacts.
- ❑ SIMM memory modules support FPM and EDO DRAM memory types. DIMM memory modules support FPM, EDO and SDRAM (unbuffered) memory types.
- ❑ Singled-sided and double-sided memory modules are supported.
- ❑ The same type and size of memory for every bank recommended. Different memory types and sizes in separate banks will cause the performance of the memory to run at the speed of the slowest RAM installed.

Memory Usage

The following information lists sample configurations for utilizing both SIMM and DIMM memory modules:

SIMM Configurations

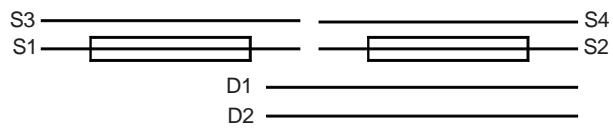

or

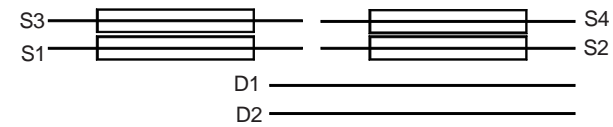

DIMM Configurations

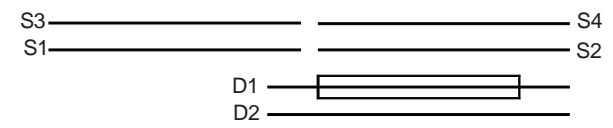

or

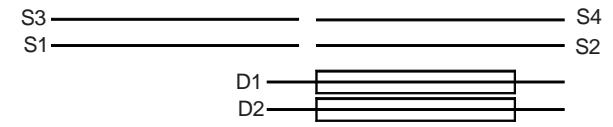

SIMM and DIMM Configurations

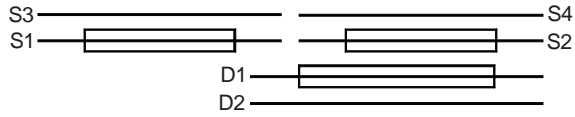

or

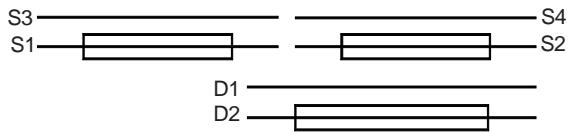

S = SIMM
D = DIMM

NOTE:

DIMM socket 1 is a shared socket with SIMM sockets 3 and 4. A shared socket means that either SIMMs or DIMMs may occupy, but not together. Therefore, if you are using a DIMM in DIMM socket 1, you may not use SIMM sockets 3 and 4 at the same time.

Memory Configurations

The following tables list the most common memory configurations. The memory available depends on the number of DIMMs and/or SIMMs installed.

Memory Size	SIMM 1	SIMM 2	SIMM 3	SIMM 4	DIMM 1	DIMM 2
8MB	1Mx32	1Mx32	-	-	-	-
16MB	2Mx32	2Mx32	-	-	-	-
16MB	1Mx32	1Mx32	1Mx32	1Mx32	-	-
24MB	1Mx32	1Mx32	2Mx32	2Mx32	-	-
32MB	4Mx32	4Mx32	-	-	-	-
32MB	2Mx32	2Mx32	2Mx32	2Mx32	-	-
40MB	1Mx32	1Mx32	4Mx32	4Mx32	-	-
48MB	2Mx32	2Mx32	4Mx32	4Mx32	-	-
64MB	8Mx32	8Mx32	-	-	-	-
64MB	4Mx32	4Mx32	4Mx32	4Mx32	-	-
72MB	1Mx32	1Mx32	8Mx32	8Mx32	-	-
80MB	2Mx32	2Mx32	8Mx32	8Mx32	--	--
96MB	4Mx32	4Mx32	8Mx32	8Mx32	-	-
128MB	16Mx32	16Mx32	-	-	-	-
128MB	8Mx32	8Mx32	8Mx32	8Mx32	-	-
136MB	1Mx32	1Mx32	16Mx32	16Mx32	-	-
144MB	2Mx32	2Mx32	16Mx32	16Mx32	-	-
160MB	4Mx32	4Mx32	16Mx32	16Mx32	-	-
256MB	32Mx32	32Mx32	-	-	-	-

Table 3-1: Memory Configurations (SIMMs Only)

Chapter 3: Installing the Twister AT

Memory Size	SIMM 1	SIMM 2	SIMM 3	SIMM 4	DIMM 1	DIMM 2
24MB	1Mx32	1Mx32	1Mx32	1Mx32	-	-
32MB	1Mx32	1Mx32	1Mx32	1Mx32	-	-
48MB	1Mx32	1Mx32	1Mx32	1Mx32	-	-
48MB	2Mx32	2Mx32	2Mx32	2Mx32	-	-
64MB	2Mx32	2Mx32	2Mx32	2Mx32	-	-
80MB	1Mx32	1Mx32	1Mx32	1Mx32	-	-
96MB	2Mx32	2Mx32	2Mx32	2Mx32	-	-
96MB	4Mx32	4Mx32	4Mx32	4Mx32	-	-
128MB	4Mx32	4Mx32	4Mx32	4Mx32	-	-
144MB	1Mx32	1Mx32	1Mx32	1Mx32	-	-
160MB	2Mx32	2Mx32	2Mx32	2Mx32	-	-
192MB	8Mx32	8Mx32	16Mx32	16Mx32	-	-
192MB	4Mx32	4Mx32	4Mx32	4Mx32	-	-
192MB	8Mx32	8Mx32	8Mx32	8Mx32	-	-
256MB	16Mx32	16Mx32	16Mx32	16Mx32	-	-
256MB	8Mx32	8Mx32	8Mx32	8Mx32	-	-

Table 3-2: Memory Configurations (SIMMs Only)

Memory Size	SIMM 1	SIMM 2	SIMM 3	SIMM 4	DIMM 1	DIMM 2
8MB	-	-	-	-	1Mx64	-
16MB	-	-	-	-	2Mx64	-
16MB	-	-	-	-	1Mx64	1Mx64
24MB	-	-	-	-	1Mx64	2Mx64
32MB	-	-	-	-	4Mx64	-
32MB	-	-	-	-	2Mx64	2Mx64
40MB	-	-	-	-	1Mx64	4Mx64
48MB	-	-	-	-	2Mx64	4Mx64
64MB	-	-	-	-	8Mx64	-
64MB	-	-	-	-	4Mx64	4Mx64
72MB	-	-	-	-	1Mx64	8Mx64
80MB	-	-	-	-	2Mx64	8Mx64
96MB	-	-	-	-	4Mx64	8Mx64
128MB	-	-	-	-	8Mx64	8Mx64
256MB	-	-	-	-	16Mx64	16Mx64

Table 3-3: Memory Configurations (DIMMs Only)

Memory Size	Bank 0		Bank 1		DIMM 1	DIMM 2
	SIMM 1	SIMM 2	SIMM 3	SIMM 4		
8MB to 256MB	1Mx32	1Mx32 to 16Mx32 16Mx32 in any combination	-	-	1Mx64	-
			-	-	2Mx64	-
			-	-	4Mx64	-
			-	-	8Mx64	-
			-	-	1Mx64	1Mx64
			-	-	1Mx64	2Mx64
			-	-	1Mx64	4Mx64
			-	-	1Mx64	8Mx64
			-	-	2Mx64	2Mx64
			-	-	2Mx64	4Mx64
			-	-	2Mx64	8Mx64
			-	-	4Mx64	4Mx64
			-	-	4Mx64	8Mx64
256MB	-	-	8Mx64	8Mx64		
24MB	1Mx32 1Mx32 to 16Mx32 16Mx32 in any combination		-	-	1Mx64	
to			-	-	2Mx64	
			-	-	4Mx64	
256MB			-	-	16Mx64	

Table 3-4: Memory Configurations (Mixing SIMMs & DIMMs)

NOTE:

- Use the same type and size of memory for every bank.
- When mixing different memory types, the memory will default to the speed of the slowest RAM installed.

Installing a CPU

The Twister AT is designed to support Intel Pentium, Cyrix and AMD processors. Follow the steps below to install a processor:

1. Turn off the computer and remove its cover.
2. Locate the CPU ZIF socket illustrated in Figure 2-1.
3. Lift the lever of the socket.
4. Locate pin 1 on the processor and pin 1 on the socket (refer to Figure 2-1). Gently place the processor into the socket, making sure pin 1 on the processor and pin 1 on the socket are aligned.
5. Push the lever down until it locks into place.
6. Make sure the speed and the voltage selection jumpers are set correctly (refer to Chapter 2 - Jumper Settings).

WARNING: *Pentium processors require a heat-sink with a cooling fan. Failure to provide adequate cooling of the processor may seriously affect system performance or cause permanent damage to the processor.*

NOTE: *The heat sink mounting spring can be directly mounted on the ZIF socket 7.*

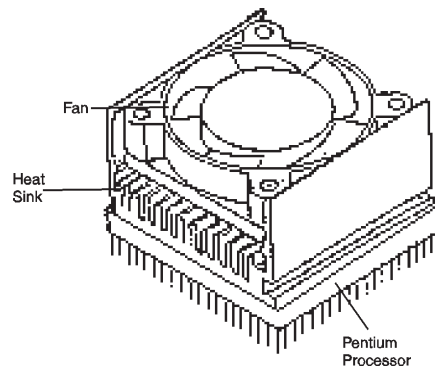

Installing the DIMMs

To install the DIMMs, locate the memory banks on the system board and perform the following steps:

1. Hold the DIMM so that the notched edge is aligned with the notch on the DIMM socket (Figure 3-2).
NOTE: If notched edges do not match, you are probably using the incorrect type of DIMM (unbuffered).
2. Insert the DIMM at a 90 degree angle.
3. Gently push the DIMM straight down until it locks into place (past the release tabs).

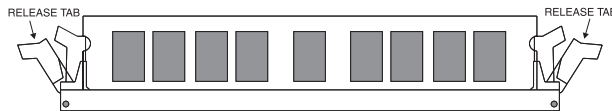

Figure 3-1: Installing a 168-Pin DIMM

Removing DIMMs

To remove DIMMs, follow the steps below:

1. With both thumbs (or fingers), press the release tabs away from the socket.
2. With the DIMM free from the release tabs, lift the module up and place in an anti-static bag or package.

Installing the SIMMs

To install the SIMMs, locate the memory banks on the system board and perform the following steps:

1. Hold the SIMM so that the notched edge is aligned with the notch on the SIMM socket (Figure 3-1).
2. Insert the SIMM at a 45 degree angle.
3. Gently push the SIMM into an upright position until it locks into place (past the release tabs).

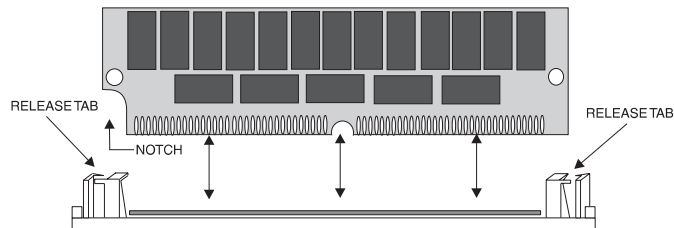

Figure 3-2: Installing a 72-Pin SIMM

Removing SIMMs

To remove SIMMs, follow the steps below:

1. With both thumbs (or fingers), press the release tabs away from the socket.
2. With the SIMM free from the release tabs, lift the module up and place in an anti-static bag or package.

Installing a PCI Peripheral Card

Micronics PCI slots accommodate all PCI peripherals that meet the PCI 2.1 specifications. Follow the steps below to install a PCI card:

1. Turn the computer system off and remove its cover.
2. Choose an unused PCI slot and remove the slot cover.
3. Insert the card with the bottom edge level to the slot.
Never insert the card at an angle.
4. Carefully push the card straight down, making sure the card is fully inserted.
5. Replace the screw which holds the card in place.
6. Replace the computer cover.
7. Refer to the PCI card's documentation additional instructions regarding installation and software drivers.

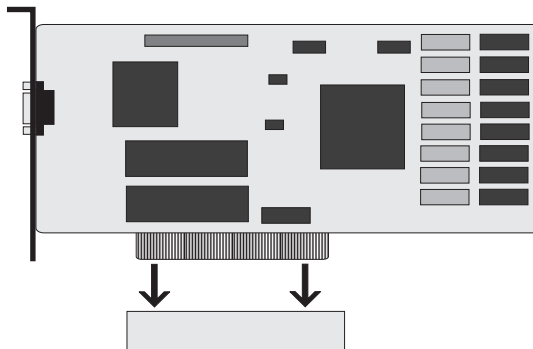

Figure 3-3: Installing a PCI Card

Installing an ISA Peripheral Card

Micronics ISA slots accommodate all standard ISA peripherals. Follow the steps below to install a PCI card:

1. Turn the computer system off and remove its cover.
2. Choose an unused ISA slot and remove the slot cover.
3. Insert the card with the bottom edge level to the slot. *Never insert the card at an angle.*
4. Carefully push the card straight down, making sure the card is inserted fully.
5. Replace the screw that holds the card in place.
6. Replace the computer cover.
7. Refer to the ISA card's documentation for additional instructions regarding installation and software drivers.

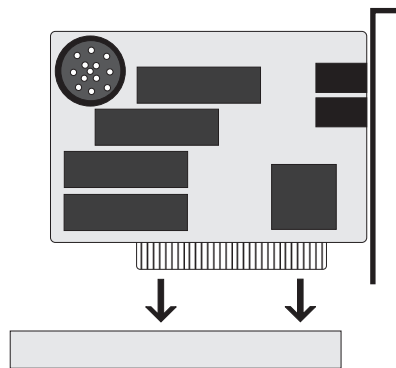

Figure 3-4: Installing an ISA Peripheral Card

Configuration

After the Twister AT system board and all hardware is installed, the system is ready for configuration. Before turning on the computer, make sure all cables are correctly connected and all jumpers are correctly set.

We recommend that you keep the computer cover off the first time you boot the system. This makes it faster and easier to correct any difficulties that might arise.

Initial Boot Up

Power up the Twister AT. If the system does not properly boot, check all your cables and peripherals for bad connections. You may also get beep codes or error messages. If this occurs, consult Appendix B for a guide to possible solutions.

After the system properly boots, it is ready to be configured. The following information explains the proper procedures for BIOS configuration.

Setup

The Setup program is used to configure the computer's BIOS (Basic Input/Output System). The computer's BIOS is responsible for configuring the system board and providing hardware information to the operating system. In order for the computer to run properly, run the Setup procedure after first installing the system board and whenever you make a hardware change to the system.

Chapter 4: The BIOS Setup Utility

When the system is turned on, it performs a memory test, and a BIOS identification and system information screen is displayed on your monitor, as shown in Figure 4-1.

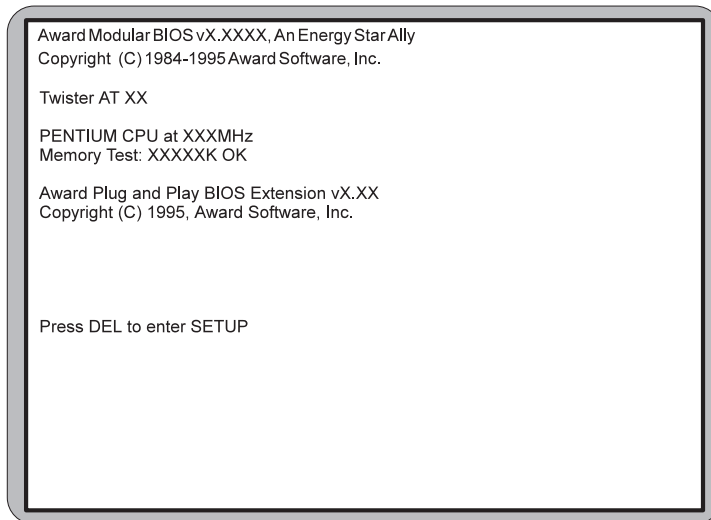

Figure 4-1: Power-Up Screen

When “To enter Setup before boot, press CTRL-ALT-ESC or DEL key” appears at the bottom of the screen, press the key to start the Setup program. The main CMOS Setup utility screen (Figure 4-2) appears. Note that the Setup program can only be activated during the boot sequence.

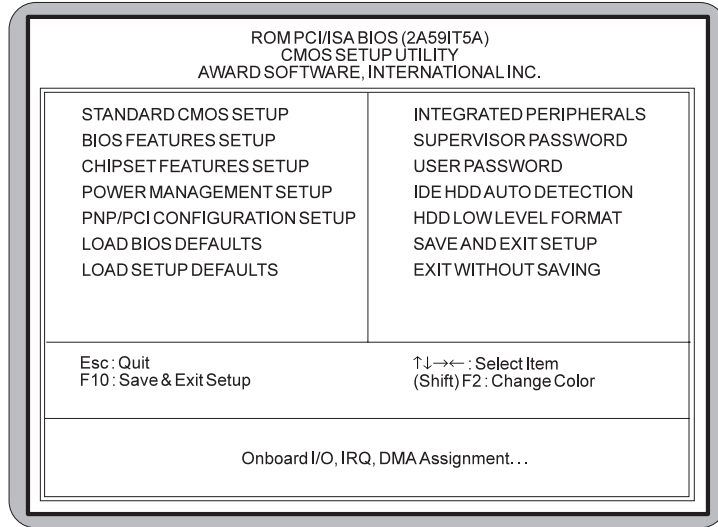

Figure 4-2: Main CMOS Setup Screen

Running the Setup Program

The Twister AT system board has six primary CMOS configuration screens: main setup menu, Standard CMOS Setup, BIOS Features Setup, Chipset Features Setup, PNP/PCI Configuration and Integrated Peripherals screen.

In addition, there are four screens containing options that do not have to be set unless you want to: the Power Management Setup screen, the Supervisor Password, the User Password and the IDE HDD Auto Detection screen. The main menu screen also contains the following options: Load BIOS Defaults, Load Setup Defaults, HDD Low Level Format, Save & Exit Setup and the Exit Without Saving.

To select any of these screens or options, use the arrow keys (<↑←↓→>) to move the highlight to the desired item and press <Enter>. *NOTE: A brief description of each highlighted selection appears at the bottom of the screen.*

Standard CMOS Setup

The STANDARD CMOS SETUP allows checking or modification of general configuration information. To access the STANDARD CMOS SETUP screen, highlight this option on the main menu screen and press <Enter>.

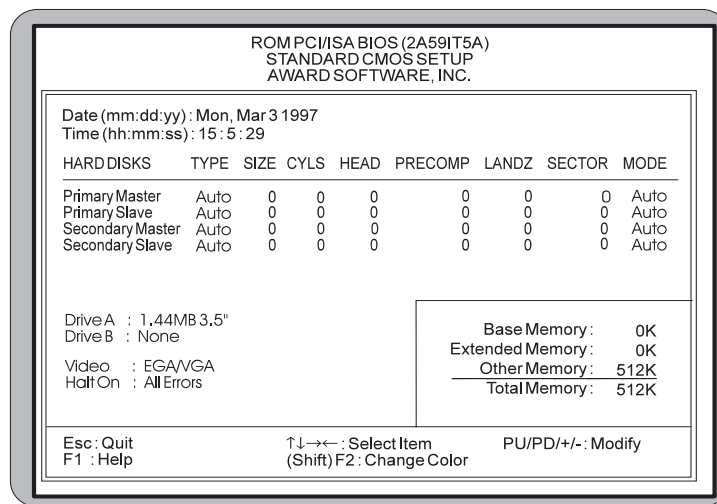

Figure 4-3. Standard CMOS Setup Screen

Date and Time

To set the date, use <→/←↑/↓> arrow keys to highlight the date and follow the same procedure to set the time.

Hard Disks Setup

The BIOS supports up to four IDE drives. You can specify the physical and electronic properties of the disk drives installed. Relevant specifications include the type, number of cylinders (CYLS), heads (HEAD), write pre-

compensation time (PRECOMP), read/write head landing zone (LANDZ), number of sectors per track (SECTOR), and HDD mode (MODE). *NOTE: We recommend that you select type Auto for all drives.*

Diskette A or B

To configure a floppy drive added to or removed from your computer, use <→/←↑/↓> arrow keys to select the desired drive. Use the <PU/PD/+/-> arrow keys to change the setting until it matches the floppy drive you installed. The BIOS supports 2.88MB, 1.44MB, 1.2MB, 720KB and 360KB floppy drives.

Video

Select the type of video card installed into your system. The default setting is EGA/VGA.

Halt On

During the Power-On Self-Test (POST), the system stops if the BIOS detects a hardware error. The default setting is All Errors.

Base/Extended/Other Memory

A small section in the lower right corner of the screen displays important information about your system that includes the base, extended and other memory sizes. They are updated automatically by the Setup program according to the status detected by the BIOS self-test.

BIOS Features Setup

This feature allows you to set the Award enhanced BIOS options of your choice. To access the BIOS FEATURES SETUP screen, highlight this option on the main menu screen and press <Enter>.

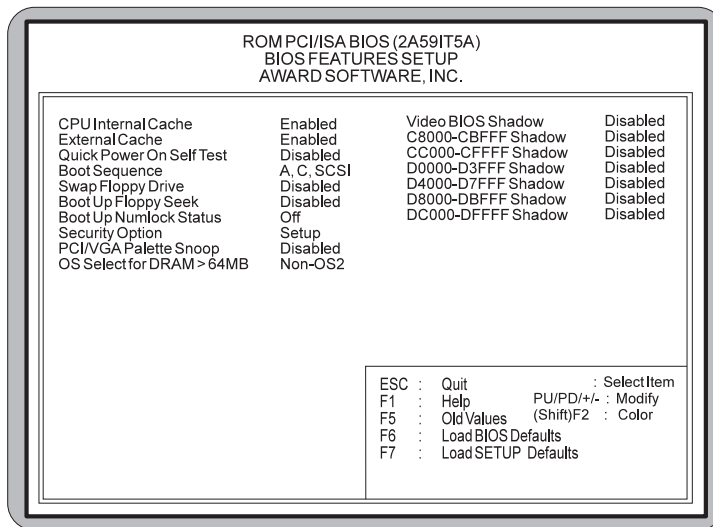

Figure 4-4: BIOS Features Setup Screen

CPU Internal Cache

This selection enables the internal CPU. The default setting is Enabled.

External Cache

The External Cache selection enables or disables the external (L2) cache and the onboard secondary cache. The default setting is Enabled.

Quick Power-On Self-Test

When enabled, this selection will reduce the amount of time required to run the Power-On Self-Test (POST). A quick POST skips certain steps. We recommend that you disable quick POST. The default setting is Disabled.

Boot Sequence

Boot Sequence selects the order in which the system searches for a boot disk. The default setting is A, C, SCSI.

Swap Floppy Drive

This selection can be set to remap the floppy drives. When set to Enable, drive A: becomes drive B: and drive B: becomes drive A:.

Boot Up Floppy Seek

When set to Enabled, the BIOS tests (seeks) floppy drives to determine whether they have 40 or 80 tracks. Drives with 720KB, 1.2MB and 1.44MB capacity all have 80 tracks. The default setting is Disabled.

Boot Up Numlock Status

Toggle between On and Off to control the state of the NumLock key when the system boots. When toggled On, the numeric keypad generates numbers instead of controlling cursor operations. The default setting is Off.

Security Option

This selection determines whether the password will be asked for in every system boot or only when entering into the Setup (default) program.

PCI/VGA Palette Snoop

Alters the VGA palette setting while graphic signals pass through the feature connector of the VGA card and are processed by the MPEG card. Enable this option only if you have MPEG connections through the VGA feature connector; this means you can adjust PCI/VGA palettes. The default setting is Disabled.

OS Select for DRAM>64MB

This selection allows you to select the amount of memory installed for your operating system. Select NON-OS2 (default) if your operating system has less than 64MB of memory. If your operating system has more than 64MB of memory installed, select the OS2 setting.

Video BIOS Shadow

Enabling this selection allows you to shadow the BIOS on the video card for faster video performance. Some video cards do not support video BIOS shadowing. Disable this option if problems occur.

Chipset Features Setup

The Chipset Features Setup allows you to program the Intel 430TX PCI chipset features. To access the CHIPSET FEATURES SETUP screen, highlight this option on the main menu screen and press <Enter>.

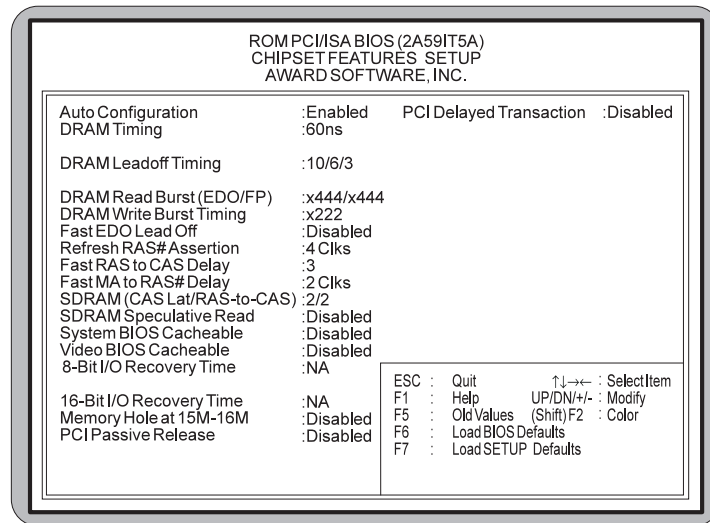

Figure 4-5: Chipset Features Setup Screen

Auto Configuration

Auto Configuration selects predetermined optimal values of the chipset parameters. When Disabled, chipset parameters revert to setup information stored in CMOS. Many fields in this screen are not available when Auto Configuration is Enabled.

DRAM Timing

This selection configures the DRAM read/write timing for maximum performance. The options are 60ns (default) and 70ns. NOTE: Before changing this selection, verify the speed of the DRAM currently installed.

Chapter 4: The BIOS Setup Utility

WARNING: An incorrect setting could cause the system to lockup. You will need to clear the CMOS and run the Setup program again.

DRAM R/W Leadoff Timing

Select the combination of CPU clocks the DRAM on your board requires before each memory read/write. Changing the value from the setting determined by the board manufacturer for the installed DRAM may cause memory errors.

DRAM Read Burst (EDO/FP)

Sets the timing for reads from EDO or FPM memory. The lower the timing numbers, the faster the system addresses memory. Selecting timing numbers lower than the installed DRAM is able to support can result in memory errors.

DRAM Write Burst Timing

Sets the timing for writes to memory. The lower the timing numbers, the faster the system addresses memory. Selecting timing numbers lower than the installed DRAM is able to support can result in memory errors.

Fast EDO Leadoff

Select Enabled only when using EDO DRAMs with either synchronous cache or in a system without cache.

Refresh RAS# Assertion

Select the number of clock cycles in which the RAS# is asserted for refresh cycles.

Fast RAS to CAS Delay

When DRAM is refreshed, both rows and columns are addressed separately. This selection allows you to determine the timing of the transition from RAS to Column Address Strobe (CAS).

Fast MA to RAS# Delay

The values in this field are preset based on the DRAM installed. Do not change the values unless you change the specifications of the installed DRAM or the installed CPU.

SDRAM (CAS Lat/RAS-to-CAS)

This selection sets the CAS latency and RAS-to-CAS delays. The default setting is 2/2.

SDRAM Speculative Read

You can enable or disable the system chipset's ability to speculate on a DRAM read address, thereby reducing read latencies. The default setting is Disabled.

System BIOS Cacheable

Selecting Enabled allows caching of the system BIOS ROM at F0000h-FFFFFh, resulting in better system performance. However, if any program writes to this memory area, a system error may result.

Video BIOS Cacheable

Selecting Enabled allows caching of the video BIOS ROM at C0000h to C7FFFh, resulting in better video performance. However, if any program writes to this memory area, a system error may result.

8-Bit/16-Bit I/O Recovery Time

The I/O recovery mechanism adds bus clock cycles between PCI-originated I/O cycles to the ISA bus. This delay takes place because the PCI bus is so much faster than the ISA bus. These two fields let you add recovery time (in bus clock cycles) for 16-bit and 8-bit I/O.

Memory Hole at 15M-16M

You can reserve this area of system memory for the ISA adapter ROM. When this area is reserved, it cannot be cached.

PCI Passive Release

When Enabled, CPU to PCI bus accesses are allowed during passive release. Otherwise, the arbiter only accepts another PCI master access to local DRAM.

PCI Delayed Transaction

The chipset has an embedded 32-bit posted write buffer to support delay transaction cycles. Select Enabled to support compliance with PCI specification version 2.1.

Power Management Setup

The Power Management Setup option controls the power management functions of the system. To access the POWER MANAGEMENT SETUP screen, highlight this option on the main menu screen and press <Enter>.

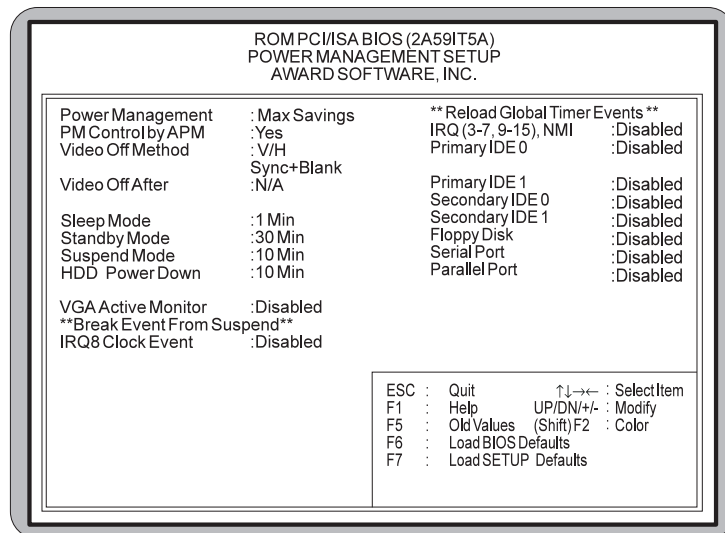

Figure 4-6: Power Management Screen

Power Management

This selection allows you to select the type (or degree) of power saving for Sleep, Standby and Suspend modes. The options are: Maximum Power Savings, User Defined and Minimum Power Savings.

Max Saving	Maximum power savings. Inactivity period is 1 minute in each mode.
User Define	Set each mode individually. Select time-out periods in the PM Timers section.
Min Saving	Minimum power savings. Inactivity period is 1 hour in each mode (except the hard drive).

PM Control By APM

When enabled, power management is controlled by the Advanced Power Management (APM) feature, which gives better power savings. The default setting is YES.

Video OFF Method

This selection defines the video off method in standby mode. The following table describes each option:

SYNC+Blank	System turns off vertical and horizontal synchronization ports and writes blanks to the video buffer.
DPMS Support	Select this option if your monitor supports the Display Power Management Signaling (DPMS) standard of the Video Electronics Standards Association (VESA). Use the software supplied for your video subsystem to select video power management values.
Blank Screen	System only writes blanks to the video buffer.

Sleep Mode

After the selected period of system inactivity (1 minute to 1 hour), the CPU clock runs at slower speed while all other devices still operate at full speed.

Standby Mode

After the selected period of system inactivity (1 minute to 1 hour), the fixed disk drive and the video shut off while all other devices still operate at full speed.

Suspend Mode

After the selected period of system inactivity (1 minute to 1 hour), all devices except the CPU shut off.

HDD Power Down

After the selected period of drive inactivity (1 to 15 minutes), the hard disk drive powers down while all other devices remain active.

VGA Active Monitor

Select whether or not video activity restarts the global timer for Standby Mode.

IRQ 8 Clock Event

Sets the monitoring of IRQ8 (Real Time Clock) so that it does not awaken the system from Suspend Mode.

Reload Global Timer Events

You can disable monitoring of common interrupt requests so they do not awaken the system from, or reset activity timers for Standby mode.

PnP/PCI Configuration Setup

The PnP/PCI Configuration Setup option sets the various system functions and internal addresses of PnP and PCI devices and onboard PCI IDE controller. To access the PnP/PCI CONFIGURATION SETUP screen, highlight this option on the main menu screen and press <Enter>.

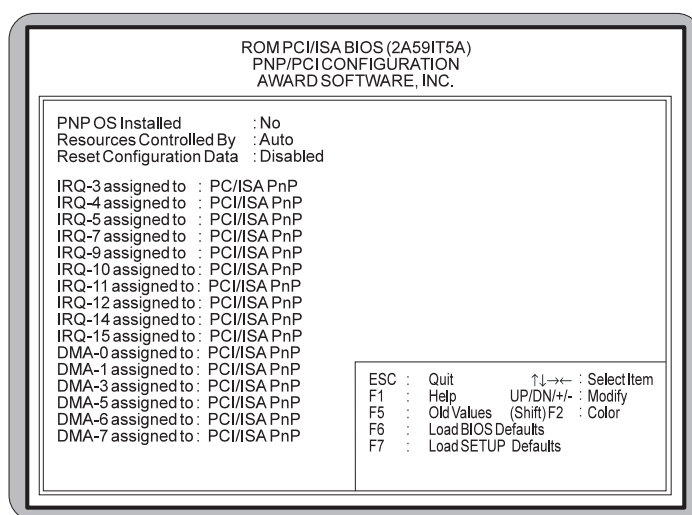

Figure 4-7: PnP/PCI Configuration Screen

PnP OS Installed

When set to Yes, this selection allows the system to work with a Plug and Play (PnP) operating system such as Windows 95. The PnP BIOS will configure only PCI and ISA Plug and Play cards needed to boot the system, and allow the operating system or device drivers to configure the remaining cards. The default setting is No.

Resources Controlled By

The Twister AT's Plug and Play BIOS can automatically configure all the boot and Plug and Play-compatible

devices. If you select Auto (default) all the interrupt request (IRQ) and DMA assignment fields disappear, as the BIOS automatically assigns them.

Reset Configuration Data

Select Enabled to reset Extended System Configuration Data (ESCD) when you exit Setup. This selection allows the PnP BIOS to detect your PCI and ISA PnP devices and reallocate resources to them. The default setting is Disabled.

IRQ *n* Assigned To

When resources are controlled manually, assign each system interrupt as one of the following types, depending on the type of device using the interrupt:

Legacy ISA Devices compliant with the original PC AT bus specification, requiring a specific interrupt (such as IRQ4 for COM 1) or older ISA cards that use jumpers to adjust resources.

PCI/ISA PnP Devices compliant with the Plug and Play standard, whether designed for PCI or ISA bus architecture.

DMA *n* Assigned To

When resources are controlled manually, assign each system DMA channel as one of the following types, depending on the type of device using the interrupt:

Legacy ISA Devices compliant with the original PC AT bus specification, requiring a specific DMA channel or older ISA cards that use jumpers to adjust resources.

PCI/ISA PnP Devices compliant with the Plug and Play standard, whether designed for PCI or ISA bus architecture.

Load BIOS Defaults

This selection loads the BIOS default values that would allow safe booting of the system in the event of a BIOS configuration memory loss. To select LOAD BIOS DEFAULTS, highlight this option on the main menu screen and press <Enter>. Press <Y> or <N> when the program prompts you with the Load BIOS Defaults question.

Load Setup Defaults

This selection allows automatic configuration of all the options in the Standard CMOS Setup, BIOS Features Setup and Chipset Features Setup with the setup defaults. If problems are encountered after loading the setup defaults, reboot the system and load the BIOS defaults. To select LOAD SETUP DEFAULTS, highlight this option on the main menu screen and press <Enter>. Press <Y> or <N> when the program prompts you with the Load Setup Defaults question.

Integrated Peripherals

This option sets the addresses of I/O subsystems that depend on the integrated peripherals controller in your system. To access the INTEGRATED PERIPHERALS screen, highlight this option on the main menu screen and press <Enter>.

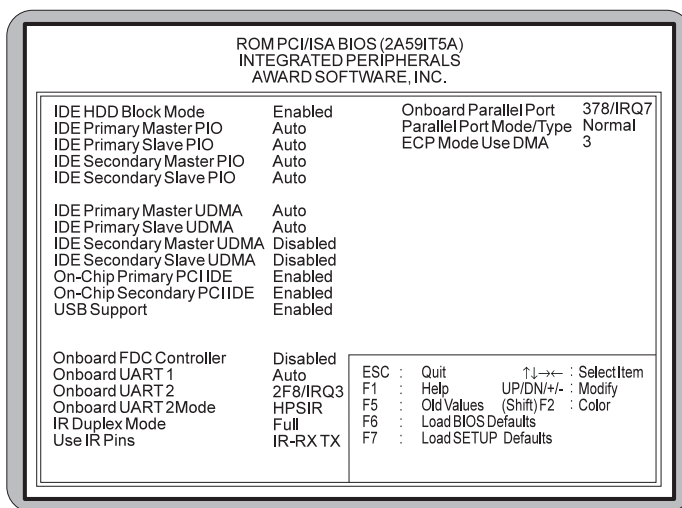

Figure 4-8: Integrated Peripherals Configuration Screen

IDE HDD Block Mode

Block mode is also called block transfer, multiple commands, or multiple sector read/write. If your IDE hard drive supports block mode (most new drives do), select Enabled (default) for automatic detection of the optimal number of block read/writes per sector the drive can support.

IDE Primary/Secondary Master/Slave PIO

The four IDE PIO (Programmed Input/Output) fields allow you to set a PIO mode (0-4) for each of the four IDE

devices that the onboard IDE interface supports. Modes 0 through 4 provide successively increased performance. In Auto (default) mode, the system automatically determines the best mode for each device.

IDE Primary/Secondary Master/Slave UDMA

Set the UDMA (Ultra DMA/33) mode for the specified onboard IDE interface. Ultra DMA/33 is a hard drive interface protocol that increases the burst data transfer rate to 33MBytes per second. NOTE: Your hard drive and operating environment must both support the UDMA mode.

On-Chip Primary/Secondary PCI IDE

The integrated peripheral controller contains an IDE interface with support for two IDE channels. Select Enabled to activate each channel separately.

USB Support

Select Enabled (default) if your system contains a Universal Serial Bus (USB) controller, and you have USB peripherals and an operating system that supports USB.

Onboard FDC Controller

Select Enabled to use the floppy disk controller installed on the system board. If you install an add-in controller or the system has no floppy drive, select Disabled (default).

Onboard UART 1/2

Select a logical COM port name and matching address for the first and second serial ports.

Onboard UART 2Mode

Set the Infrared mode for the second serial port. The options are: HPSIR - IRDA compliant serial infrared port, and ASKIR - amplitude shift keyed infrared port.

IR Duplex Mode

Select the value required by the IR device connected to the IR port. The options are: Full Duplex Mode - permits simultaneous two-direction transmission, and Half Duplex Mode - permits transmission in one direction only at a time.

Onboard Parallel Port

Select an address and interrupt for the physical parallel (printer) port.

Parallel Port Mode/Type

Select an operating mode for the onboard parallel (printer) port. Select Normal (default) unless your hardware and software require one of the other modes offered in this field.

ECP Mode Use DMA

Select a DMA channel for the parallel port when using ECP (Extended Capabilities Port) mode.

Supervisor Password

The Supervisor Password utility allows you to setup, change or disable the password stored in the BIOS. The Supervisor Password allows access to the system and Setup. To setup or change a password, highlight the SUPERVISOR PASSWORD option on the main menu screen and press <Enter>.

The password can be no more than eight characters long. The program will prompt you to confirm the new password before exiting and enabling the utility. To disable the password, press <Enter> when the program prompts you to enter the new password.

WARNING: If you forget the Supervisor Password, it cannot be disabled without resetting the CMOS.

User Password

The User Password utility allows you to setup, change or disable the password stored in the BIOS. Follow the same procedure used to setup the Supervisor Password. The User Password allows access to the system, but will not allow you to modify the CMOS settings.

NOTE: The User Password can only be set after setting the Supervisor password.

IDE HDD Auto Detection

The IDE HDD Auto Detection option provides auto configuration of the hard drive installed in your system. To access the IDE HDD Auto Detection screen, highlight this option on the main menu screen and press <Enter>.

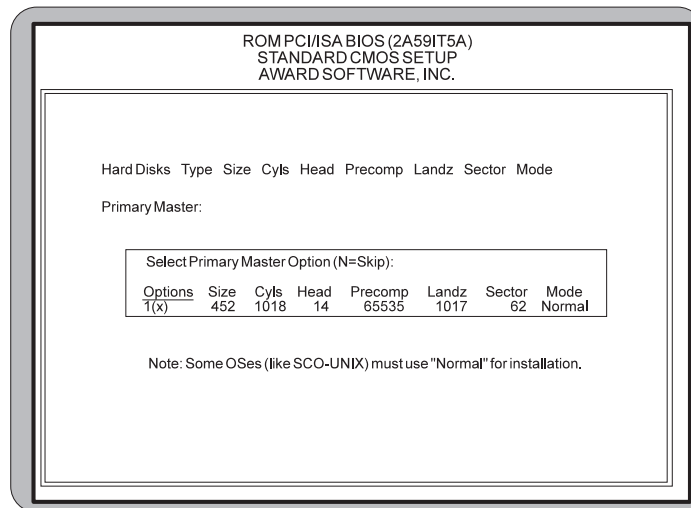

Figure 4-9: IDE HDD Auto Detection Screen

The IDE HDD Auto Detection option provides auto configuration of the hard drive installed in your system. It supports LBA, Large and Normal modes.

If your hard disk drive's capacity is under 528MB, select Normal mode. NOTE: It is recommended that you select Normal mode for your hard disk drive if you will be using UNIX. If the system's hard disk drive has a capacity of over 528MB and supports LBA functions, you may enable either the LBA mode or the Large Mode.

HDD Low Level Format

Micronics recommends that only trained technicians use this utility. This selection allows you to perform a low level format of your hard disk drive. To select the HDD LOW LEVEL FORMAT option, highlight this option on the main menu screen and press <Enter>.

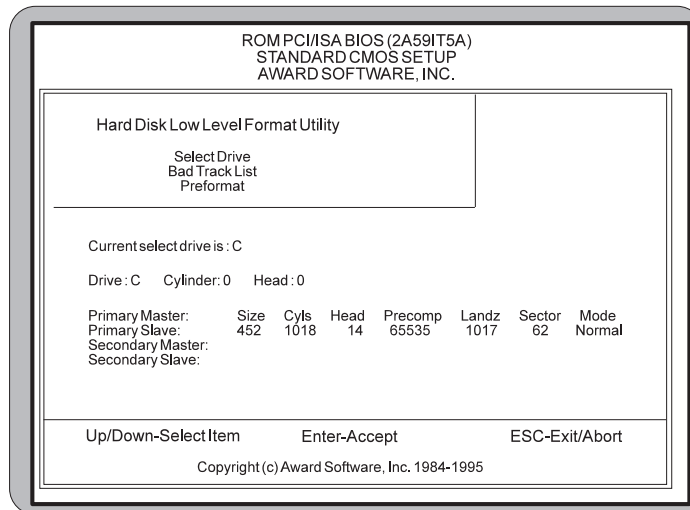

Figure 4:10: HDD Low Level Format Screen

The selections available are: Low Level Format Utility, Select Drive Bad Track List and Preformat.

WARNING: This utility should not be run on an IDE or EIDE hard drive unless the manufacturer of the hard drive instructs you to do so.

Save and Exit Setup

This selection saves the changes you have made in the setup program, then exits and reboots the system. After making all modifications in the setup program, exit to the main menu screen. Highlight the SAVE AND EXIT SETUP option and press <Enter>. Press <Y> to confirm the changes made and <N> or <ESC> if additional modifications are needed before exiting the setup program.

Exit Without Saving

This selection abandons all previous settings, then exits and reboots the system. From the main menu screen highlight the EXIT WITHOUT SAVING option and press <Enter>. Press <Y> and the system will exit the setup program, then reboot without saving any of the changes made.

Appendix ***Specifications***

A

Part Number: 09-00317-xx

Processor: Single ZIF socket 7
Intel Pentium® 75-200MHz (P54C)
Intel Pentium® 166-233MHz Processors
w/ MMX™ (P55C).
Pentium® Overdrive (P54CTB)
Cyrix™ 6x86
AMD-K5™ and AMD-K6™
Integrated VRM

Chipset: Intel 430TX PCI chipset
Intel PIIX 4
SMC FDC37C66x Ultra I/O chip

CPU Clock
Select: Support for 50, 60 & 66MHz CPU bus

Form Factor: Baby AT

Expansion: Five 32-bit PCI slots
Four 16-bit ISA slots
(One is a shared PCI/ISA slot)

BIOS: Award BIOS w/ 1MB Flash
PCI auto configuration
APM 1.2
Auto-detection of memory size
Auto-detection and display of EDO and
SDRAM memory.
Auto-configuration of IDE disk drives
Multi-Boot
DMI

Memory : Maximum Memory - 256MB
Four 72-pin SIMM sockets
Two 3.3V unbuffered 168-pin DIMM
sockets.

Appendix A: Technical Information

	Supports FPM, EDO and SDRAM memory
Keyboard/Mouse:	AT style keyboard and PS/2 mouse connector via cable.
Internal Cache:	256K or 512K Pipelined Burst Level 2 cache soldered onboard.
I/O Ports:	Two high speed serial ports (16550 compatible) Enhanced 15-pin parallel port w/ EPP and ECP Ultra DMA/33 IDE IrDA compliant IR header Two USB ports via cable w/ bracket
Floppy Port:	Supports two floppy drives (2.88MB, 1.44MB, 1.2MB, 720KB, 360KB).
PCI IDE Ports:	Two 40-pin IDE connectors (Primary and Secondary IDE). Multiple sector transfer support Auto detection of add-in IDE board

Environmental Specifications

The environment in which the Twister AT is located is critical. Micronics recommends the following environmental specifications:

Temperature Range

Operating: 50 to 104 degrees Fahrenheit (10 to 40 degrees Celsius).
Non -Operating: 50 to 140 degrees Fahrenheit (10 to 60 degrees Celsius).
Shipping: -22 to 140 degrees Fahrenheit (-30 to 60 degrees Celsius).

Relative Humidity

Operating: 20% to 80%.
Non-Operating: 5% to 90%.

Battery Disposal

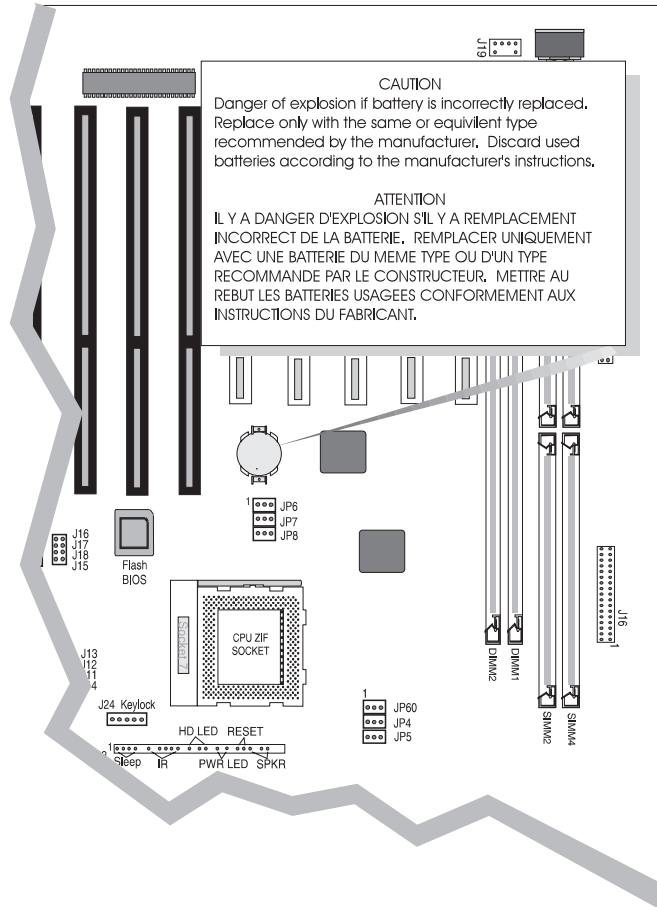

Please do not open battery, dispose of in fire, recharge, put in backwards or mix with used or other battery types. The battery may explode or leak and cause personal injury.

Support and Information Services

Micronics offers a variety of support and information services to help you get the most from your product. The following services are available:

- ▲ Technical Support
- ▲ Electronic Bulletin Board Service (BBS)
- ▲ Return Materials Authorization (RMA)
- ▲ Fax-On-Demand
- ▲ World Wide Web
- ▲ Customer Service

Refer to Table A-1 for details on these services.

Technical Support

If you need technical assistance, our Technical Support Engineers will be glad to help you. You can contact us via telephone, fax or BBS. Before calling Technical Support please have the following information ready:

- The model name and 09 part number of your Micronics product, which is silkscreened on the face of the Twister AT system board.
- Your computer information such as CPU type, operating system, amount of installed memory and other peripherals installed in your computer.
- Try to call from the location of your computer.

NOTE: For Return Material Authorization purposes, please keep a copy of your product receipt.

Appendix A: Technical Information

Service	Hours	Country	Telephone Number
Technical Support - Live phone help from Technical Support Engineers	M-F: 7:00am to 5:00pm (PST)	USA France UK	(510) 661-3000 (510) 651-6982 (Fax) +33 (1) 45 43 56 26 +33 (1) 45 43 17 78 (Fax) +44 (1256) 844899 +44 (1256) 364222 (Fax)
Electronic Bulletin Board Service (BBS) - Information on software upgrades, new releases and other helpful information	24 hours a day 7 days a week "	USA UK	(510) 651-6837 14400 baud rate, Parity=N, Data Bits=8, Stop Bits=1 YMODEM and ZMODEM (recommended file transfer protocols) +44 (1256) 363373
RMA (Return Materials Authorization) - Return products for repair	M-F: 8:00am to 4:45pm (PST)	USA	(510) 661-3030 (510) 683-0543 (Fax)
Fax-On-Demand - Automated system for product literature, technical bulletins and other helpful information	24 hours a day 7 days a week	USA	(510) 661-3199
World Wide Web - Product information, technical support, press releases and other helpful information	24 hours a day 7 days a week "	USA Europe	http://www.micronics.com http://www.mcrni.com
Customer Service - Order Micronics and Orchid products	M-F: 8:00am to 5:00pm (PST)	USA France UK Germany Taiwan	(800) 577-0977 (510) 651-3666 (Fax) +33 (1) 45 43 56 26 +33 (1) 45 43 17 78 (Fax) +44 (1256) 479 898 +44 (1256) 364222 (Fax) +49 (89) 58 09 82 55 +49 (89) 58 09 82 25 (Fax) +886 2 918 5005 +886 2 911 5472 (Fax)

Table A-1: Support and Information Services

Appendix A: Technical Information

Appendix ***POST Messages***

B

During the Power-On Self Test (POST), the BIOS either sounds a beep code or displays a message when it detects a correctable error. Currently the only beep code indicates that a video error has occurred and the BIOS cannot initialize the video screen to display any additional information. The beep code consists of a single long beep followed by two short beeps.

Message	Possible Cause	Solution
BIOS ROM CHECKSUM ERROR - SYSTEM HALTED	The checksum of the BIOS code in the BIOS chip is incorrect, indicating the BIOS code may have become corrupt.	Requires a BIOS replacement.
CMOS BATTERY FAILED	CMOS battery is no longer functional.	Requires a battery replacement.
CMOS CHECKSUM ERROR-DEFAULTS LOADED	Checksum of CMOS is incorrect, so the system loads the default equipment configuration.	This error may have been caused by a weak battery. Check the battery and replace if necessary.
DISKETTE DRIVES OR TYPES MISMATCH ERROR	Type of diskette drive installed in the system is different from the CMOS configuration.	Run Setup to reconfigure the drive type correctly.
DISPLAY SWITCH IS SET INCORRECTLY	The display switch on the system board can be set to either monochrome or color. This message indicates the switch is set to a different setting than indicated in Setup.	Determine which setting is correct. Then either turn off the system and change the jumper, or enter Setup and change the Video selection.
KEYBOARD ERROR OR NO KEYBOARD PRESENT	Cannot initialize the keyboard.	Make sure the keyboard is attached correctly and no keys are pressed during POST. Check the Halt On configuration in Setup. May require replacement of keyboard.

Appendix B: POST Messages

Message	Possible Cause	Solution
KEYBOARD IS LOCKED OUT - UNLOCK THE KEY	This message usually indicates that one or more keys have been pressed during the keyboard tests.	Be sure no objects are resting on the keyboard.
FLOPPY DISK(s) FAILED	Cannot find or initialize the floppy drive controller or the drive.	Make sure the controller is installed correctly. If no floppy drives are installed, be sure the Diskette Drive selection in Setup is set to None or Auto.
HARD DISK INSTALL FAILURE	Cannot find or initialize the hard drive controller or the drive.	Make sure the controller is installed correctly. If no hard drives are installed, be sure the Hard Drive selection in Setup is set to None.
HARD DISK(s) DIAGNOSTICS FAILED	The system may run specific disk diagnostic routines. This message appears if one or more hard disks return an error when running the diagnostics.	Rerun Setup and check connections. May require a hard disk replacement.
PRIMARY MASTER HARD DISK FAILED	POST detects an error in the primary master IDE hard drive.	May require a replacement of the primary master hard disk.
PRIMARY SLAVE HARD DISK FAILED	POST detects an error in the secondary master IDE hard drive.	May require a replacement of the secondary master hard disk.
SECONDARY MASTER HARD DISK FAILED	POST detects an error in the primary slave IDE hard drive.	May require a replacement of the primary hard disk.
SECONDARY SLAVE HARD DISK FAILED	POST detects an error in the secondary slave IDE hard drive.	May require a replacement of the secondary slave hard disk.

Appendix B: POST Messages

Message	Possible Cause	Solution
MEMORY TEST FAILED	If POST detects an error during memory testing, additional information appears giving specifics about the type and location of the memory error.	May require replacement of defective memory.
MEMORY PARITY ERROR AT.....	Indicates a memory parity error at a specific location.	You can use this location along with the memory map for your system to find and replace the defective memory chips.
PRESS F1 TO DISABLE NMI. F2 TO REBOOT	The BIOS detected a nonmaskable Interrupt condition during boot.	Reboot the system with the NMI enabled.
OVERRIDE ENABLED - DEFAULTS LOADED	If the system cannot boot using the current CMOS configuration, the BIOS can override the current configuration.	The BIOS contains a set of defaults designed for the most stable, minimal-performance system operations.

Appendix B: POST Messages

Appendix

C

Updating the System BIOS

The Micronics system boards are designed so that the BIOS can be reprogrammed using a BIOS file. You can easily FLASH a BIOS by following the steps below:

- 1) After downloading the appropriate BIOS file from our BBS or Website, extract it to a bootable MS-DOS 6.X or Windows 95 diskette.
- 2) If you are using MS-DOS 6.X, reboot your system with the bootable diskette in the A: drive. To make sure a clean DOS environment is loaded, press the F5 key while "Starting MS-DOS" is displayed. After the system has rebooted, the cursor will appear at the A:\> prompt.
- 3) If you are using Windows 95, press F8 when you see "Starting MS Windows 95." Select the option "Safe Mode Command Prompt."
- 4) Now you can run the FLASH utility from the bootable floppy disk. Refer to the README.TXT file included with the BIOS update for detailed instructions.
- 5) After the FLASH screen appears, select [Y]es to save the current BIOS or [N]o if you do not want to save the current BIOS. NOTE: It is recommended that you save the current BIOS.
- 6) When prompted, select [Y]es to reprogram the BIOS.
- 7) After the update process has completed, you will be prompted to power off or reset your system. Once the system reboots, verify that the new BIOS version appears on the screen. NOTE: After reprogramming the BIOS, you may need to enter Setup and reset your settings.



If you encounter any problems during this process, or if you have questions about the procedure, please call Technical Support.

Appendix C: Updating the System BIOS

NOTE: If the BIOS is somehow erased or does not seem to accept the upgrade, you can purchase a new BIOS from MicroNiche Information Systems (800-733-9188). There is a \$30.00 fee plus shipping charges for this service. (Price and availability subject to change.)

If you prefer to send your system board in for the upgrade, the Micronics RMA department offers this service free of charge if your system board is under warranty.

Appendix ***Limited Warranty***

D Except as described below, Micronics warrants the products to be free from defects in material and workmanship in normal use for a period of one (1) year from date of purchase. Should any product fail to perform according to this warranty at any time during the warranty period, except as provided below, Micronics or its authorized service centers will, at Micronics' option, repair or replace the product at no additional charge.

The warranty does not cover loss or damage which occurs in shipment or which is due to: (1) improper installation or maintenance, misuse, neglect or any cause other than ordinary commercial application, including without limitation, accidents or acts of God; (2) adjustment, repair, or modification by other than a Micronics authorized service center; (3) improper environment, excessive or inadequate heating or air conditioning, or electrical power failures, surges or other irregularities; (4) any statement about the product other than those set forth in this warranty; or (5) nonconformity to models or samples shown to the purchaser. Any models or samples were for the sole purpose of suggesting the character of the product and are not intended to form the basis of the bargain.

A receipt or copy of the invoice with the date of purchase from a Micronics reseller is required before any warranty service can be rendered. Service can be obtained by calling Micronics for a Return Merchandise Authorization (RMA) Number.

The RMA Number should be prominently displayed on the outside of the shipping carton of the returned product. Returned product should be shipped prepaid or hand carried to Micronics. The purchaser assumes risk of loss or damage in transit, and unless otherwise agreed to in writing by Micronics, will pay inbound shipping charges.

The exclusive remedy of the purchaser under this warranty above will be repair or replace at Micronics' option,

Appendix D: Warranties and Notices

but if for any reason that remedy should fail of its essential purpose, the exclusive remedy of the purchaser shall then be actual damages up to amounts paid for the defective product by the purchaser. This limited warranty shall be deemed to “fail of its essential purpose” if, after repeated efforts, Micronics is unable to make the product operate as warranted. Micronics’ liability for damages to the purchaser for any cause whatsoever; regardless of the form of action and whether in contract or in tort, shall be limited to the purchase price in effect when the cause of action arose for the product that is the basis of the claim.

Micronics will not be liable for any lost profits or any indirect, special incidental or consequential damages in connection with the product, even if Micronics has been advised of the possibility of such damages.

Micronics makes no warranties or representations as to performance of products or as to service to distributor or to any person, except as set forth in Micronics; limited warranty accompanying delivery of product.

Micronics disclaims all other warranties whether oral, written, expressed, or implied, including without limitation, the warranties of design, merchantability, or fitness for a particular purpose, if applicable, or arising from a course of dealing, usage or trade practice.

Non-Warranty Service

After the one year warranty service is no longer in effect, repair service is still available for Micronics products. For more information, contact Micronics’ RMA department at (510) 661-3030. The RMA department is open between 8:30 A.M. and 4:45P.M. Pacific Standard Time.

FCC Statement

This equipment has been tested and found to comply within the limits for a Class B digital device, pursuant to Part 15 of the FCC Rules. These limits are designed to provide reasonable protection against harmful interference in a residential installation. This equipment generates, uses and can radiate radio frequency energy and, if not used in accordance with the instructions, may cause harmful interference to radio communications. Interference to radio or television reception can be determined by turning the equipment off and on. You are encouraged to try to correct the interference by one or more of the following measures:

- ▲ Reorient the receiving antenna.
- ▲ Increase the separation between the equipment and the receiver.
- ▲ Connect the equipment into an outlet on a circuit different from that to which the receiver is connected.
- ▲ Consult your dealer or an experienced radio/TV technician for help.

To meet FCC requirements, shielded cables are required.

NOTE: Changes or modifications not expressly approved by Micronics could void your authority to operate the equipment.

Glossary

16550 UART - A high speed chip for controlling serial ports. Although unnecessary for a mouse, it is required for modems that are 14,400 baud or faster.

APM - An acronym for Advanced Power Management. The APM specification defines a layer of software that supports power management in computers with power manageable hardware.

Asynchronous - Operations that do not require the clocks of communicating devices to be coordinated. See Synchronous.

Bidirectional Parallel Port - A type of parallel port that can send and receive information.

BIOS - An Acronym for Basic Input/Output System. Configures the system board and provides hardware information to the operating system.

Bit - A contraction of Binary digit. The smallest unit of information in a binary number system. A bit represents a choice between either zero or one.

Boot - To start up the computer and load the operating system software. See cold boot and warm boot.

Buffered DIMMs - The 168-pin buffered DIMM modules use buffer logic chips on their control lines to reduce loading on the system board. This buffering action increases the maximum number of modules on the same sys-

tem board. The buffered DIMMs come with standard DRAM chips for 3.3V operation.

Bus - A group of electronic paths used to send data between parts of the system. On a system board, the bus connects the peripheral cards with the microprocessor via the expansion slots.

Bus Mastering - The ability of a peripheral card to control the bus without requiring intervention of the CPU.

Byte - A group of adjacent bits treated as a unit. Eight bits are typically considered one byte. Also called a character.

Cache - A process where information is copied from the slower memory (DRAM) to the faster memory (SRAM). Information that is likely to be read or edited is stored in the cache providing significant performance increases.

Cold Boot - Starting the computer by turning on the power or pressing the RESET button. A cold boot makes the processor execute all of the diagnostics. See boot and warm boot.

CPU - An acronym for Central Processing Unit. A CPU performs arithmetic calculations, makes logical decisions, and directs the operation of the computer in conjunction with the operating system.

DIMM - An acronym for Dual Inline Memory Module. A small printed circuit board containing memory chips.

Disk Drive - A hardware device which provides for the storage of data on diskettes or hard metal disks that have a magnetic coating. A disk drive functions by spinning at high speed while moving a device called the read/write head across the disk's surface in order to read or write data in magnetic code.

DMI - An acronym for Desktop Management Interface.

DRAM - An acronym for Dynamic Random Access Memory. A type of memory chip that only keeps its memory if supplied with regular clock pulses and a chance to regularly refresh its data. It is slower and more cost effective than SRAM. See SRAM.

ECP - An acronym for Expanded Capabilities Port. A standard set by Hewlett Packard and Microsoft Corporation to expand the capabilities of the parallel port.

EDO Memory - An acronym for Extended Data Out. A DRAM performance feature that permits multiple bit of data in a single row to be accessed quickly.

EPP - An acronym for Enhanced Parallel Port. A standard which increases the capabilities of the parallel port.

EPROM - Acronym for Erasable Programmable Read Only Memory. A type of ROM chip that can be programmed with relatively simple tools

that will retain its data until erased. It can only be erased by exposing the circuitry in the chip to ultraviolet light. See also Flash ROM.

Flash ROM - A type of ROM chip that will retain its data until erased. It can be erased or reprogrammed by supplying it with +12V of voltage. See ROM and EPROM.

FPM - An acronym for Fast Page Mode. A timing option that permits several bits of data in a single row on a DRAM to be accessed at an accelerated rate.

Gigabyte - A disk storage capacity measurement. Approximately one thousand megabytes or 1,073,741,824 bytes.

IDE - An acronym for Integrated Device Electronics. A standard for communicating between a hard drive and a computer.

Internal Cache - Cache which is built into the CPU. See Cache.

ISA - An acronym for Industry Standard Architecture. A well-established bus standard that originated with the IBM AT. See *PCI and VESA Local Bus*.

NS - An acronym for Nanosecond. One billionth of a second. Measure of the access time of RAM.

Parallel - A form of data transmission in which the data is sent one byte at a time over several wires that each carry one byte. In parallel transmission, all

Glossary

the bytes arrive simultaneously, as opposed to serial transmission in which bits arrive one by one.

Parallel Port - A connection for a printer or similar peripheral. Generally, parallel ports are output only. See Bidirectional Parallel Port and ECP.

Parity - Logic that detects the presence of an error in memory. Generally, a single parity bit is used for each byte (8 bits) of data. The most commonly used forms of parity are even parity, odd parity and checksums.

PCI - An acronym for Peripheral Component Interconnect. A high performance 32-bit or 64-bit bus developed by Intel Corporation. PCI is designed to be independent of the hardware architecture to ensure compatibility with future computer systems. See *VESA Local Bus and ISA*.

Pentium - A high performance 64-bit CISC processor designed and manufactured by Intel Corporation.

Pipeline - In DRAMs and SRAMs, a method for increasing the performance using multistage circuitry to stack or save data while new data is being accessed.

Plug and Play - A standard developed to ensure easy installation of peripherals. Theoretically, a newly installed card will automatically configure itself and work properly without requiring jumper configuration or device drivers.

POST - An acronym for Power On Self Test. A diagnostic program that is run whenever the system is cold booted.

RAM - An acronym for Random Access Memory. A type of memory that is used as the “working memory” of a computer system. See DRAM and SRAM.

ROM - An acronym for Read Only Memory. A type of memory that retains its data without requiring power. Once written, it cannot be modified. See EPROM and Flash ROM.

Serial Port - A communications port used to connect peripherals such as modems and mice.

Setup - A program that allows you to make changes to the system configuration.

Shadow RAM - A technique used to load a duplicate copy of BIOS from slower ROM into faster RAM. This enhances system performance because it provides higher access speed to the BIOS.

SIMM - An acronym for Standard Inline Memory Module. A small printed circuit board containing memory chips.

SDRAM - Synchronous Dynamic Random Access Memory or Synchronous DRAM. A DRAM designed to deliver bursts of data at very high speed using automatic addressing, multiple page interleaving and a synchronous (or clocked) interface.

SRAM - An acronym for Static Random Access Memory. A type of memory that can retain data without requiring a regular clock signal. Although they are faster than DRAM, they hold less data and are more expensive.

Synchronous - Protocols that require the clocks of communicating machines or devices to be coordinated.

Synchronous Cache - A type of cache that uses a clock signal to latch the inputs and the data output. This structure spreads the cache access across two or three cycles while maintaining a bandwidth of one access per cycle. Improves performance by 5-10%.

Terabyte - A measurement for very large storage capacity. One Terabyte is equivalent one-thousand gigabytes, one-million megabytes, or 1,099,511,627,766 bytes.

Ultra DMA/33 IDE - A hard drive interface protocol that increases the burst data transfer rate to 33MBytes per second.

Unbuffered DIMMs - The unbuffered DIMM modules do not use any buffer logic chips, thus achieving faster operation due to the elimination of the propagation delay of the logic buffer. This increase in speed comes at the cost of reducing the maximum number of modules on the same system board.

USB - An acronym for Universal Serial Bus. The simple and flexible way to connect devices to your desktop or notebook PC. USB allows virtually un-

limited PC expansion with no more hassles over add-in cards, dip switches, jumper cables, software drivers, IRQ settings, DMA channels and I/O addresses. With USB, you can attach and detach peripherals without opening the computer or even shutting it down.

VESA - An acronym for Video Electronics and Standards Association.

VESA Local Bus (VL-Bus) - A high performance bus designed by VESA. A 32-bit version of the ISA bus which operates at the speed of the computer's CPU. See *PCI and ISA*.

VRM - Voltage Regulator Module. Supplies CPU specific voltages for the CPU.

Warm Boot - Restarting the system by simultaneously pressing the <Ctrl>, <Alt> and <Delete> keys.

Write-Back Cache - Upon a cache hit, the cache is updated and the main memory is not affected. Upon a cache miss, only the main memory is updated.

Write-Through Cache - Upon a cache hit, the cache and the main memory are updated. Upon a cache miss, only the main memory is updated.

Index

B

- Battery Disposal - 61
- POST Messages - 65
- BIOS
 - Configuration - 33
 - Setup - 33, 35
- Bulletin Board System (BBS) - 63

C

- Configuring the Twister AT - 13

D

- Diagram (Twister AT) - 14

E

- Extended Data Out (EDO) Memory - 19, 21
- Environmental Specifications - 60

F

- Fast Page Mode (FPM) Memory - 19, 21

H

- Help
 - Bulletin Board System (BBS) - 63
 - Telephone Numbers - 63
 - Troubleshooting - 65

I

Installation

CPU - 28

Installing your Twister AT - 19

ISA Peripheral Card - 32

PCI Peripheral Card - 31

Quick Installation - 9

J

Jumper Settings - 15

M

Twister AT System Board Diagram - 14

Memory

Adding - 21

Configurations - 24

Removing - 29, 30

Supported - 19

O

Online Services - 63

P

POST Messages - 65

S

SDRAM (Synchronous DRAM) Memory - 19, 21

Specifications - 59

System BIOS - 33, 69

Index

T

- Technical Specifications - 59
- Technical Support - 62
- Troubleshooting - 65

U

- Updating the System BIOS - 69
- Utility Programs
 - BIOS Features Setup - 38
 - Chipset Features Setup - 41
 - Exit Without Saving - 57
 - HDD Low Level Format - 56
 - IDE HDD Auto Detection - 55
 - Integrated Peripherals - 51
 - Load BIOS Defaults - 50
 - Load Setup Defaults - 50
 - PnP/PCI Configuration Setup - 48
 - Power Management Setup - 45
 - Save and Exit Setup - 57
 - Standard CMOS Setup - 36
 - Supervisor Password - 54
 - User Password - 54

W

- World Wide Web - 63