M6Mi Pentium Pro
PCI/ISA
System Board Manual

MICRONICS
COMPUTERS INC.

Document Number: 06-00264-02, Rev. 3A
May 1997
45365 Northport Loop West, Fremont, CA 94538

Copyright Notices

Copyright © 1996, 1997 Micronics Computers, Inc. The information contained in the M6Mi PCI/ISA system board manual has been carefully checked and is believed to be accurate. Micronics assumes no responsibility for any inaccuracies that may be contained in this document. Micronics makes no commitments to update or to keep the information in this manual at a current level when changes are made to the product.

Micronics reserves the right to make improvements to this document and/or product at any time and without notice. All Rights Reserved. No part of this document may be photocopied, reproduced, translated, or reduced to any medium or machine form without prior, written consent from Micronics.

Portions of the Manual

Portions of this manual were copied (with permission) from Phoenix Technologies, Ltd. All rights reserved.

Trademarks

IBM is a registered trademark of International Business Machines. Microsoft and Windows are registered trademarks of Microsoft Corporation. Intel and PCI are registered trademarks of Intel Corporation. All other product names mentioned herein are used for identification purposes only and may be the trademarks of their respective companies.

Table of Contents

Introduction	5
Features	6
Software Compatibility	7
Before You Begin	8
Section 1 - Quick Installation	9
Installing the M6Mi	9
Section 2 - Configuring the M6Mi	11
Static Electricity	11
Office Environment	11
M6Mi System Board	12
M6Mi Back Panel Connections	13
Jumper Settings	13
Section 3 - Installing the M6Mi	17
Introduction	17
System Memory Support	17
Installing the M6Mi	18
Tools Required	18
Equipment Required	18
System Memory	19
SIMMs Supported	19
Adding Memory	19
Memory Configurations	20
Installing the SIMMs	22
Removing SIMMs	22
Installing a CPU	23
Installing a PCI Peripheral Card	24
Installing an ISA Peripheral Card	25

Installing a CD-ROM Drive	26
The M6Mi Sound Option	27
Connecting Sound Devices	27
Connecting the Telephony Option	28
Section 4 - The BIOS Setup Utility	29
Configuration	29
Initial Bootup	29
Setup	29
Running the Setup Procedure	31
Setting the Main Screen	31
Setting the Advanced Screen	36
Security Screen	39
Power Screen	42
Boot Screen	44
Exit Screen	46
Section 5 - Installing Sound Device Drivers	47
About Device Drivers	47
Installing the Sound Drivers	48
Appendix A - Technical Information	49
Specifications	49
Environmental Specifications	50
Temperature Range	50
Relative Humidity	50
Battery Disposal	51
Technical Support	52
Online Services	53

Appendix B - Post Messages	55
Appendix C - Beep and POST Codes	57
Appendix D - Hard Disk Drive Types	61
Appendix E - Updating the System BIOS	63
Appendix F - Warranties and Notices	65
Non-Warranty Service	66
FCC Statement	67
Declaration of Conformity	68
Glossary	69
Index	73

List of Figures

Figure 1.1: Power-Up Screen	10
Figure 2.1: M6Mi System Board	12
Figure 2.2: M6Mi Back Panel Connections	13
Figure 3.1: Installing a 72-Pin SIMM	22
Figure 3.2: Installing a PCI Card	24
Figure 3.3: Installing an ISA Peripheral Card	25
Figure 3.4: Connecting External Sound Devices	27
Figure 4.1: Power-Up Screen	30
Figure 4.2: CMOS Main Screen	31
Figure 4.3: IDE Device Submenu	34
Figure 4.4: Advanced Screen	36
Figure 4.5: Security Setup Screen	39
Figure 4.6: Supervisor Password Submenu	40
Figure 4.7: Power Screen	42
Figure 4.8: Boot Screen	44
Figure 4.9: Exit Screen	46

List of Tables

Table 2.1: CPU Speed Selection	13
Table 2.2: CPU Voltage Selection	14
Table 2.3: AT Bus Clock Selection	14
Table 2.4: Clear CMOS Selection	14
Table 2.5: System Power On Selection	15
Table 2.6: Optional Sound Selection	15
Table 2.7: Case and Peripheral Connections	15
Table 3.1: Memory Configurations	20

Introduction

Thank you for choosing the M6Mi system board. The high-performance M6Mi supports the most advanced Pentium® Pro microprocessor technology for demanding workstation needs.

Based on the Intel 440FX PCIset, the M6Mi provides the speed and performance necessary to address the most intensive computational applications. Enhanced PCI throughput, Mode 4 IDE and support of Universal Serial Bus (USB), make this board state-of-the-art. The USB interface has a maximum bandwidth of 12Mbps and can connect as many as 127 devices to a host system. USB supports both standard devices that operate at the full 12-Mbps rate and low-end devices that use only a 1.5-Mbps subchannel.

The M6Mi is designed to fit into the most modern ATX form factor. The ATX form factor allows critical components such as floppy drive connectors, chassis fan, CPU and memory to be strategically located so that full length cards can be used in all slots.

The M6Mi comes with many features. These include support for Extended Data Out (EDO) and Fast Page Mode (FPM) DRAM memory, Error Checking Correction (ECC), the Phoenix Plug and Play BIOS and an optional feature for integrated 16-bit sound.

For energy efficiency, full support is provided for the Green PC specification. Micronics builds all products to exacting standards, using the highest quality components available. We are proud to provide this system board and believe you will be pleased with your purchase.

Features

The M6Mi includes the following features:

- ▲ Single ZIF socket 8
Intel P6, P6S and P6T
VRM header to supply CPU-specific voltages
- ▲ Intel 440FX PCIset with PIIX3 ISA bridge
SMC FDC37C93X Ultra I/O chip
- ▲ Three 32-bit PCI slots
Two 16-bit ISA slots
(One shared PCI or ISA slot)
- ▲ Up to 512K pipelined burst internal Level 2 cache
- ▲ Maximum memory - 384MB
- ▲ Supports FPM and EDO memory
ECC support via chipset
- ▲ Mode 4 enhanced IDE (supports up to four IDE devices)
- ▲ Two Universal Serial Bus (USB) ports for desktop peripheral expansion
- ▲ Creative Labs VIBRA 16C Sound (optional)
- ▲ Telephony header for desktop video conferencing (optional)

Software Compatibility

The M6Mi system board has been thoroughly tested for compatibility with a variety of operating systems and environments, including:

- ▲ Microsoft
 - DOS 5.0
 - DOS 6.2
 - Windows 95
 - Windows NT 3.51
 - Windows NT 4.0
- ▲ IBM
 - OS/2 Warp 3.0
 - OS/2 Warp 4.0
- ▲ SCO
 - UNIXWare 2.1.1
 - Open Server 5.02
 - UNIX 3.2, 4.2
- ▲ Novell NetWare 3.12
 - Novell NetWare 4.11

Before You Begin

This manual will familiarize you with the features, installation and use of your M6Mi. There are several symbols and conventions used throughout this manual to help draw your attention to a feature or to focus on important information:



When you see the Magnifying Glass, it refers to something you should take a closer look at before proceeding further.



When you see the Exclamation Mark, it gives important information on avoiding damage.

Common Names

DRAM	Dynamic Random Access Memory
ECC	Error Checking and Correction
ECP	Extended Capabilities Port
EDO	Extended Data Out
EPP	Enhanced Parallel Port
FPM	Fast Page Mode
IDE	Integrated Drive Electronics
PCI	Peripheral Component Interconnect
SIMM	Single Inline Memory Module
USB	Universal Serial Bus
VRM	Voltage Regulator Module

Section

1

Quick Installation

We know that many experienced people prefer to read as little of the documentation as possible. If this sounds like you, here's the short form to get up and running quickly.



STATIC!

Before handling the M6Mi, be properly grounded by using a special wrist or ankle strap, or touch a safely grounded object.

1. Make backup copies of your installation and configuration diskettes.
2. Ground yourself to prevent damaging static discharge, then remove the M6Mi from its packaging.
3. Configure and verify the system board's jumper settings (refer to Jumper Settings in Section 2).
4. Install the CPU and the system memory (refer to Section 3).
5. Install the system board into the chassis and make all necessary case connections.
6. Install any ISA and/or PCI add-on peripherals (refer to Section 3).
7. Now you can connect any optional devices (refer to Section 3).
8. Turn the computer on and press the <F2> key when you see the screen in Figure 1.1.

Section 1: Quick Installation

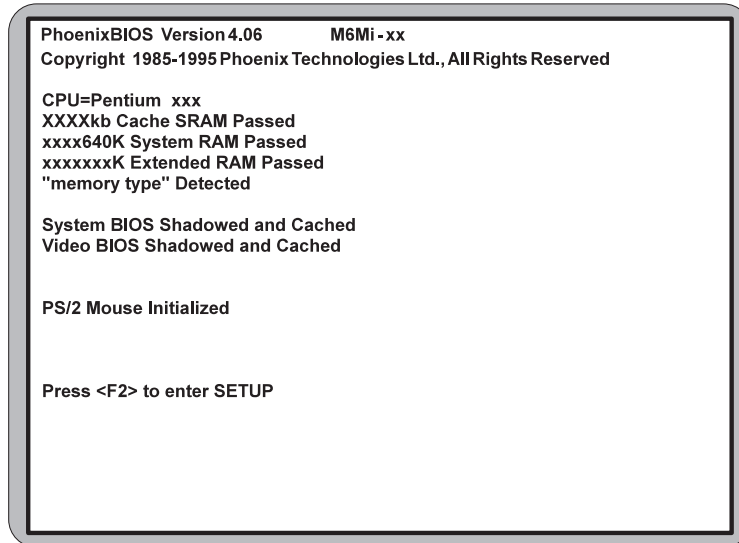

Figure 1.1: Power-Up Screen

9. Set the time and date. Adjust the BIOS settings to match your configuration. If installing an IDE drive, select the IDE device you wish to configure. Press ENTER with Autotype Fixed Disk selected and the BIOS will automatically configure the drive for you (refer to Section 4).
10. After you have configured the Main Setup menu, make any desired setting configurations in the Advanced and Security menu. When finished, go to the exit screen, select "Save Changes and Exit" and you are finished with the BIOS configuration (see Section 4).
11. Install your IDE CD-ROM drive and its device drivers (refer to Section 3).
12. Install the sound controller device drivers (optional). Refer to Section 5.

Section

2

Configuring the M6Mi

Although the M6Mi system board is packaged in protective materials, it is important to use care while unpacking and setting up.

Static Electricity

The M6Mi is shipped from the factory in an antistatic bag. To reduce the possibility of damage, it is important to neutralize any accumulated static charges on your body before handling the board.

The best way to do this is to ground yourself using a special wrist or ankle strap. If you do not have a strap, you should touch both of your hands to a safely grounded object. After you have grounded yourself, ground the M6Mi via the solder pads surrounding one of its mounting holes. Once the M6Mi is removed from its packaging, place it on top of the antistatic bag. Carefully inspect the board for damage which may have occurred during shipment.

Environment Considerations

Make sure the finished computer system is in an area with good ventilation. The system should not be in direct sunlight, near heaters, or exposed to moisture, dust or dirt.

M6Mi System Board

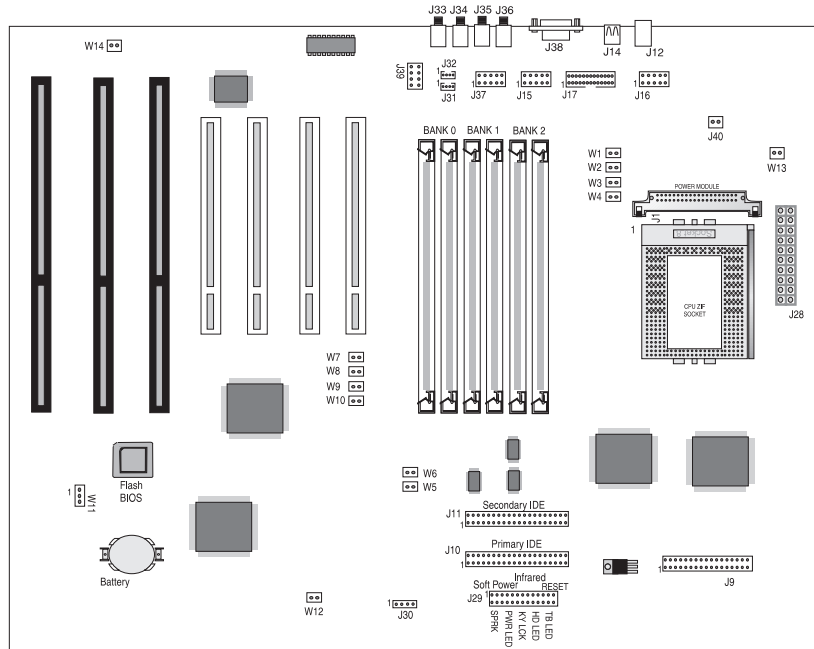

Figure 2.1: M6Mi System Board

M6Mi Back Panel Connections

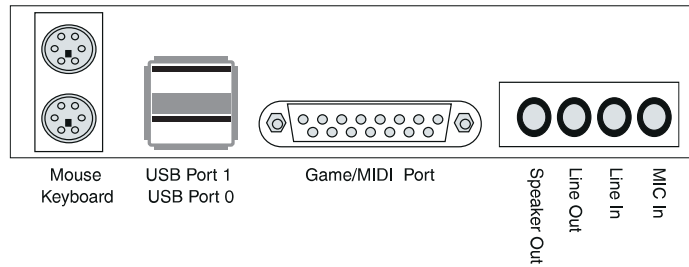

Figure 2.2: M6Mi System Back Panel Connections

Jumper Settings

This section gives you the jumper settings used for the M6Mi system board.

Table 2-1 lists the jumper settings to select the CPU speed.

	CPU Speed	150MHz	166MHz	180MHz	200MHz
Jumper					
W5		Close	Open	Close	Open
W6		Open	Close	Open	Close
W7		Close	Close	Close	Close
W8		Close	Close	Close	Close
W9		Close	Close	Open	Open
W10		Open	Open	Close	Close

Table 2-1: CPU Speed Selection

Section 2: Configuring the M6Mi

Table 2-2 lists the jumper settings for the CPU Voltage Identification (VID) selection.

CPU Voltage	W1	W2	W3	W4
VID-Enabled (default)	Open	Open	Open	Open
Non-VID 2.9V	Close	Open	Open	Close
Non-VID 3.1V	Close	Open	Close	Close
Non-VID 3.3V	Close	Close	Open	Close

Table 2-2: CPU Voltage Selection

Table 2-3 lists the jumper settings for the AT Bus clock.

Jumper	Function	Settings
W12	Default	Close

Table 2-3: AT Bus Clock Selection

Table 2-4 lists the jumper settings to clear the CMOS settings. With your computer's power off, close pins 2-3, wait ten seconds and place the jumper back on pins 1-2. (The jumper must be placed back on pins 1-2 for the system to function properly.)

NOTE: This will reset all BIOS default settings. Any changes you have made will be lost.

Jumper	Function	Settings
W11	Normal (default)	1-2
	Clear CMOS	2-3

Table 2-4: Clear CMOS Selection

Section 2: Configuring the M6Mi

Table 2-5 lists the jumper settings to enable the system power-on setting.

Jumper	Function	Settings
W13	Normal (default)	Open
	Reserved	Close

Table 2-5: System Power On Selection

Table 2-6 lists the jumper settings to select the optional onboard sound.

Jumper	Function	Settings
W14	Enable (default)	Open
	Disable	Close

Table 2-6: Optional Sound Selection

Table 2-7 lists the case and peripheral connections.

Connector	Function	Notes
J1	Power Module	
J9	Floppy Drive Connector	
J10	Primary IDE Port	
J11	Secondary IDE Port	
J12	Keyboard/Mouse Connector	PS/2
J14	USB Connectors	
J15	Serial Port (COM 2)	Can be disabled at the CMOS configuration screen
J16	Serial Port (COM 1)	Can be disabled at the CMOS configuration screen
J17	Parallel Port Connector	Can be disabled at the CMOS configuration screen

Table 2-7A: Case & Peripheral Connections

Section 2: Configuring the M6Mi

Connector	Function	Notes
J28	Power Connector	ATX standard
J29	Front I/O Connector	
"	System Power On/Off	1 - Power; 2 - Ground
"	Infrared Port Connector Note: Do not connect IR devices to J29 and J30 simultaneously	6 - Transmit Data; 7 - Ground; 8 - Receive Data; 9 - Ground; 10 - +5V DC
"	Reset Switch	12 - Reset; 13 - Ground
"	PC Speaker	14 - Speaker; 17 - +5V DC
"	Power-On LED	18 - Positive; 20 - Ground
"	Keylock Switch	21 - Keylock; 22 - Ground
"	Hard Disk LED	23 - Positive; 24 - Negative
"	Turbo LED	25 - Positive; 26 - Ground
J30	Infrared Port Connector	1 - Receive Data; 2 - Ground; 3 - Transmit Data; 4 - +5V DC
J31	CD-ROM Audio Input	1 - Ground; 2 - CD-In Left Channel; 3 - Ground; 4 - CD-In Right Channel
J32	Modem/Telephony	1 - No Connect; 2 - MIC Out; 3 - Ground; 4 - Speaker In
J33	MIC In	
J34	Audio Line In	
J35	Audio Line Out	
J36	Speaker Out	
J37	External Audio	7-8 - Left Enable; 9-10 - Right Enable
J38	Game Port/MIDI	
J39	Wavetable	
J40	CPU Fan	1 - 12+V Power; 2 - Ground

Table 2-7B: Case & Peripherals Connections

Section

3

Installing the M6Mi

Introduction

This section explains how to install the M6Mi system board, memory, CPU and peripherals.

WARNING: *Before installing or removing any peripherals or components, make sure you have a clear work space and that you adhere to all anti-static precautions described in Section 1. Micronics recommends only trained technicians install and configure the system board.*

Damage which occurs to the board while adding or removing peripherals or components may void the warranty. If problems arise while installing peripherals, contact the computer dealer where you purchased the peripheral or Micronics' Technical Support Department.

System Memory Support

The flexibility of the M6Mi is augmented by its support for ECC, EDO DRAM memory and FPM DRAM memory.

EDO memory is designed to keep data available to the processor for an extended period of time. The EDO memory support extends the performance of conventional DRAM memory. The result is an improvement in memory-access performance on the M6Mi system board.

Installing the M6Mi

Installation of the M6Mi system board depends on the type of case you use. The M6Mi is designed for the ATX form factor and must be installed in an ATX chassis. NOTE: If you are unfamiliar with installing a system board, Micronics highly recommends that you read the computer user's manual or contact your dealer's technical support department.

Tools Required

Micronics recommends using the following tools to install the M6Mi:

- Small Phillips screwdriver
- Tweezers or a pair of needle-nose pliers
- Tray (to hold loose screws)

Equipment Required

Micronics recommends using the following equipment with the M6Mi for a typical configuration:

- ATX chassis with standard hardware.
- A high-quality ATX power supply capable of providing continuous power within a 3 volt range. A power filter may be used with a noisy AC power source.
- PS/2 mouse and compatible keyboard.
- Eight ohm speaker.
- Standard ribbon cables for internal connections.
- Standard power cord (grounded).
- Heat sink with cooling fan for CPU (required).

System Memory

System memory is necessary to operate the M6Mi system board. The M6Mi has six 32/36-bit SIMM sockets and can be upgraded to 384 Megabytes of RAM. In addition, support is provided for Error Checking and Correction, Extended Data Out DRAM memory and Fast Page Mode DRAM memory. This section explains the type of SIMMs supported, list the rules for adding memory to the M6Mi, give some examples of common memory configurations and show how to physically install the new SIMMs.



For long term reliability, Micronics recommends using SIMMs with tin-plated contacts. The use of gold-plated contacts may conflict with the tin-alloy on the SIMM socket.

SIMMs Supported

The M6Mi supports the following types of 60 or 70ns SIMMs:

- 4MB (1Mx32/36)
- 8MB (2Mx32/36)
- 16MB (4Mx32/36)
- 32MB (8Mx32/36)
- 64MB (16Mx32/36)

Adding Memory

The following is a list of rules to follow when upgrading SIMMs. If you follow these rules, your upgrade should be trouble-free:

- Use 70ns or faster SIMMs.
- Upgrade SIMMs one bank at a time. Each bank must contain two SIMMs of the same size and preferably from the same manufacturer. For example, to add 16MB of memory to the system board, install two 8MB SIMMs into the same bank.
- When installing SIMMs, fill Bank 0, then Bank 1, then Bank 2.
- Install the two types of memory in separate banks. The memory will default to the speed of the slowest RAM installed.

Section 3: Installing the M6Mi

Memory Configurations

The following tables list the most common memory configurations. The memory available depends on the number of SIMMs installed.



There is no need to set any jumpers. When you reboot, the size and type of memory are automatically detected.

Memory	Bank 0	Bank 1	Bank 2
8MB	(2) 1MBx32/36		
16MB	(2) 1MBx32/36	(2) 1MBx32/36	
16MB	(2) 2MBx32/36		
24MB	(2) 1MBx32/36	(2) 1MBx32/36	(2) 1MBx32/36
24MB	(2) 2MBx32/36	(2) 1MBx32/36	
32MB	(2) 2MBx32/36	(2) 1MBx32/36	(2) 1MBx32/36
32MB	(2) 4MBx32/36		
40MB	(2) 2MBx32/36	(2) 2MBx32/36	(2) 1MBx32/36
40MB	(2) 4MBx32/36	(2) 1MBx32/36	
48MB	(2) 2MBx32/36	(2) 2MBx32/36	(2) 2MBx32/36
48MB	(2) 4MBx32/36	(2) 1MBx32/36	(2) 1MBx32/36
48MB	(2) 4MBx32/36	(2) 2MBx32/36	
56MB	(2) 4MBx32/36	(2) 2MBx32/36	(2) 1MBx32/36
64MB	(2) 4MBx32/36	(2) 2MBx32/36	(2) 2MBx32/36
64MB	(2) 4MBx32/36	(2) 4MBx32/36	
64MB	(2) 8MBx32/36		
72MB	(2) 4MBx32/36	(2) 4MBx32/36	(2) 1MBx32/36
72MB	(2) 8MBx32/36	(2) 1MBx32/36	

Table 3-1: Memory Configurations

Section 3: Installing the M6Mi

Memory	Bank 0	Bank 1	Bank 2
80MB	(2) 4MBx32/36	(2) 4MBx32/36	(2) 1MBx32/36
80MB	(2) 8MBx32/36	(2) 1MBx32/36	(2) 1MBx32/36
80MB	(2) 8MBx32/36	(2) 2MBx32/36	
96MB	(2) 8MBx32/36	(2) 2MBx32/36	(2) 2MBx32/36
96MB	(2) 4MBx32/36	(2) 4MBx32/36	(2) 4MBx32/36
96MB	(2) 8MBx32/36	(2) 4MBx32/36	
128MB	(2) 8MBx32/36	(2) 4MBx32/36	(2) 4MBx32/36
128MB	(2) 8MBx32/36	(2) 8MBx32/36	
128MB	(2) 16MBx32/36		
160MB	(2) 8MBx32/36	(2) 8MBx32/36	(2) 4MBx32/36
160MB	(2) 16MBx32/36	(2) 2MBx32/36	(2) 2MBx32/36
160MB	(2) 16MBx32/36	(2) 4MBx32/36	
192MB	(2) 8MBx32/36	(2) 8MBx32/36	(2) 8MBx32/36
192MB	(2) 16MBx32/36	(2) 4MBx32/36	(2) 4MBx32/36
192MB	(2) 16MBx32/36	(2) 8MBx32/36	
256MB	(2) 16MBx32/36	(2) 8MBx32/36	(2) 8MBx32/36
256MB	(2) 16MBx32/36	(2) 16MBx32/36	
384MB	(2) 16MBx32/36	(2) 16MBx32/36	(2) 16MBx32/36

Table 3-1B: Memory Configurations

Installing the SIMMs

To install the SIMMs, locate the memory banks on the system board and perform the following steps:

1. Hold the SIMM so that the notched edge is aligned with the notch on the SIMM socket (Figure 3-1).
2. Insert the SIMM at a 45 degree angle.
3. Gently push the SIMM into an upright position until it locks into place (past the release tabs).

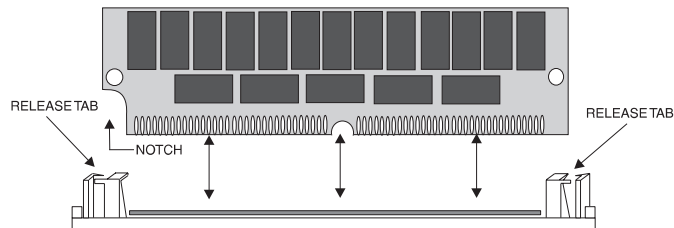

Figure 3-1: Installing a 72-Pin SIMM

Removing SIMMs

To remove SIMMs, follow the steps below:

1. With both thumbs (or fingers), press the release tabs away from the socket.
2. With the SIMM free from the release tabs, lift the module up and place in an anti-static bag or package.

Installing a CPU

The M6Mi is designed to support a variety of Intel Pentium Pro processors. Follow the steps below to install a processor:

1. Turn off the computer and remove its cover.
2. Locate the ZIF socket illustrated in Figure 2-1.
3. Lift the lever of the socket.
4. Locate pin 1 on the processor and pin 1 on the socket (refer to Figure 2-1). Gently place the processor into the socket, making sure pin 1 on the processor and pin 1 on the socket are aligned.
5. Push the lever down until it locks into place.
6. Make sure the speed selection jumpers are set correctly (refer to Section 2 - Jumper Settings).

WARNING: *Pentium Pro processors require a heat-sink with a cooling fan. Failure to provide adequate cooling of the processor may seriously affect system performance or cause permanent damage to the processor.*

Installing a PCI Peripheral Card

Micronics PCI slots accommodate all PCI peripherals that meet the PCI 2.1 specifications. Follow the steps below to install a PCI card:

1. Turn the computer system off and remove its cover.
2. Choose an unused PCI slot and remove the slot cover.
3. Insert the card with the bottom edge level to the slot.
Never insert the card at an angle.
4. Carefully push the card straight down, making sure the card is fully inserted.
5. Replace the screw which holds the card into place.
6. Replace the computer cover.
7. Refer to the PCI card's documentation additional instructions regarding installation and software drivers.

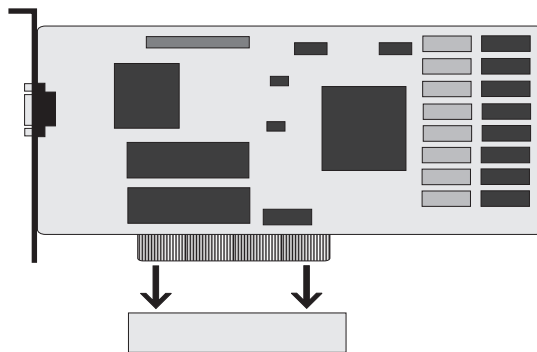

Figure 3-2: Installing a PCI Card

Installing an ISA Peripheral Card

Micronics ISA slots accommodate all standard ISA peripherals. Follow the steps below to install a PCI card:

1. Turn the computer system off and remove its cover.
2. Choose an unused ISA slot and remove the slot cover.
3. Insert the card with the bottom edge level to the slot.
Never insert the card at an angle.
4. Carefully push the card straight down, making sure the card is inserted fully.
5. Replace the screw that holds the card into place.
6. Replace the computer cover.
7. Refer to the ISA card's documentation for additional instructions regarding installation and software drivers.

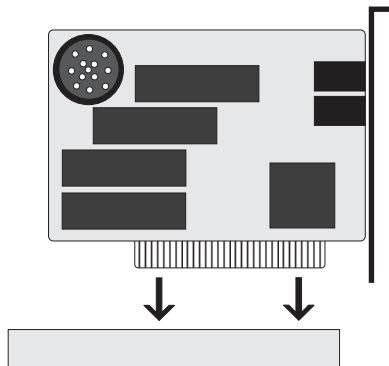

Figure 3-3: Installing an ISA Peripheral Card

Installing a CD-ROM Drive

If you are installing a CD-ROM drive, Micronics recommends the installation of an IDE CD-ROM drive. *The instructions below will help you with the installation, but also refer to the documentation that accompanied your CD-ROM drive.*

Before starting the setup and installation, make sure your computer is off and the power cord is disconnected from the wall outlet. Your CD-ROM drive kit should contain the following items for a successful installation:

- CD-ROM Drive with installation hardware
 - Interface Cable
 - CD Audio Cable
1. Connect the ribbon cable as described in the CD-ROM's documentation, making sure the red stripe on the cable is aligned with pin 1 of the connectors.
 2. Connect the audio cable to the CD-ROM drive's audio connector.
 3. Connect the other end of the audio cable to the MPC-2 compatible CD-ROM audio connector on the M6Mi system board (J31).
 4. Connect the power supply cable to the CD-ROM drive's power connector.
 5. Install the CD-ROM device drivers. CD-ROM drives require device drivers to access the drive and are generally provided by the manufacturer of the CD-ROM drive. Usually one device driver is added to the CONFIG.SYS file and one to the AUTOEXEC.BAT file.
 6. If you are using the CD-ROM drive in an MS-DOS environment, the utility MSCDEX.EXE must also be added to the AUTOEXEC.BAT file. Consult your DOS manual for more information.



Try to avoid excessive twists or bends in the cables that might damage them or interfere with other peripherals in your computer.

The M6Mi Sound Option

You can connect external sound devices to your M6Mi system board to take advantage of the optional sound support (refer to Figure 2.1). The sound option includes 16-bit stereo sound, a game/MIDI port and computer telephony support. See Section 5 for information on installing sound device drivers.

Connecting Sound Devices

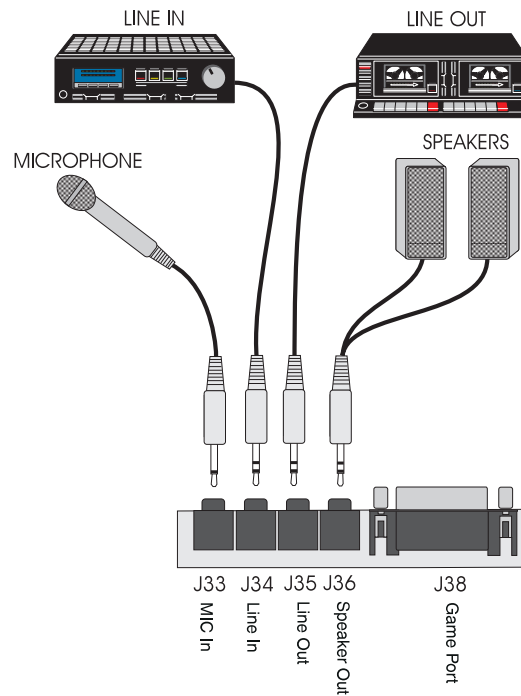

Figure 3-4: Connecting External Sound Devices

Section 3: Installing the M6Mi

Game Port

You can use the Game Port connector to connect an IBM PC compatible joystick or a MIDI instrument.

Speaker Out

You may connect 4 or 8 ohm external speakers or headphones to the audio controller.

Line Out

The Line Out jack allows you to connect the audio output of the audio controller to your home stereo, VCR or amplified speakers.

Line In

You may connect an external mono or stereo audio source to the audio controller, such as a tape player or radio. Use the appropriate converter cable to interface to your external equipment.

MIC IN

The MIC IN jack will accommodate a 300-600 ohm microphone.

Connecting the Telephony Option

The M6Mi system board can be upgraded to include a header for computer telephony (pronounced teh - leh' - fuh - nee) support. Telephony allows you to increase your communications productivity. You can integrate facsimile technology, sound and desktop video conferencing. The telephony option is enabled by connecting your modem cable to header J32.

The BIOS Setup Utility

Configuration

After the M6Mi system board and all hardware is installed, the system is ready for configuration. Before turning on the computer, make sure all cables are correctly connected and all jumpers are correctly set.

It is recommended you keep the computer cover off the first time you boot the system. This will make it easier to correct any difficulties that might arise.

Initial Boot Up

Power up the M6Mi. If the system does not properly boot, check all your cables and peripherals for bad connections. You may also get beep codes or error messages. If this occurs, consult Appendices B and/or C for a guide to possible solutions.

After the system properly boots, it is ready to be configured. The following information explains the proper procedures for BIOS configuration.

Setup

The Setup program is used to configure the computer's BIOS (Basic Input/Output System). The computer's BIOS is responsible for configuring the system board and providing hardware information to the operating system. In order for the computer to run properly, run the Setup procedure after first installing the system board and whenever you make a hardware change to the system.

Section 4: The BIOS Setup Utility

After the system is turned on and goes through a memory test, the Power-Up screen (Figure 4-1) will appear on your monitor:

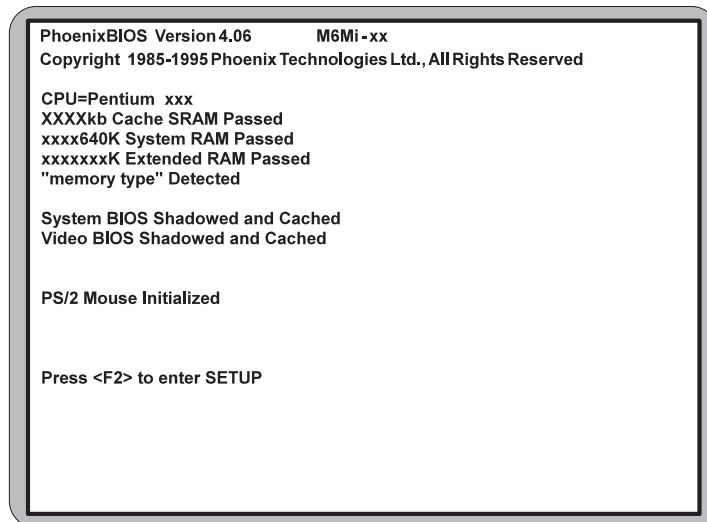

Figure 4-1: Power-Up Screen

When “Press <F2> to enter SETUP” appears at the bottom of the screen, press the <F2> key to begin the Setup procedure. The CMOS Main Screen (Figure 4-2) should appear and the prompt should be on the time line. The Setup procedure can only be activated during the boot sequence.

Running the Setup Procedure

The M6Mi system board has six primary CMOS configuration screens: Main Screen, Advanced Screen, Security Screen, Power Screen, Boot Screen and Exit Screen. To toggle between the screens, press the right arrow <→> and the left arrow <←> keys.

Setting the Main Screen

The CMOS Main screen (Figure 4-2) is used to set the time and date, to set the floppy drive types, to configure the hard disks and to configure the video. This section explains how to configure each of these categories. To move between the categories, use the up and down arrow <↑/↓> keys.

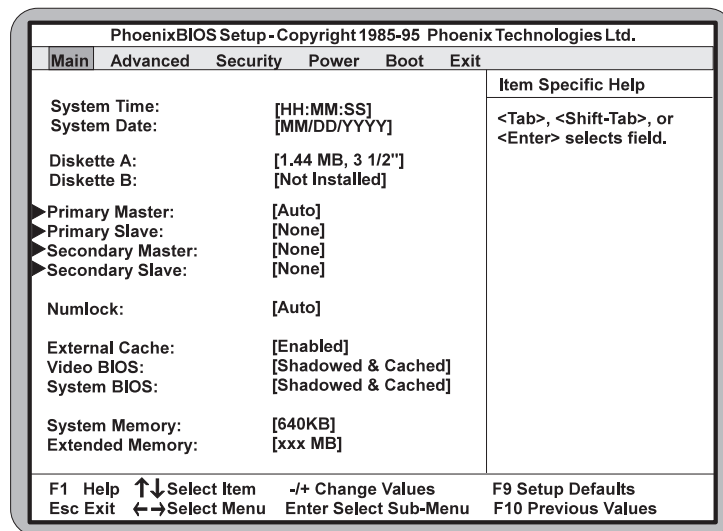

Figure 4-2: CMOS Main Screen

Section 4: The BIOS Setup Utility

System Time and Date

To set the time, use the <-> key to decrease the number and the <+> key to increase the number. To move the prompt forward, use the <Tab> key; to move the prompt backward, use the <Shift-Tab> key. To set the date, use the up and down arrows <↑/↓> to highlight the System Date and follow the same procedure used to set the time.

Diskette A or B

To configure a floppy drive added to or removed from your computer, use the up and down arrow keys <↑/↓> to select the desired drive. Use the <+/-> keys to change the setting until it matches the floppy drive you installed. The BIOS supports 2.88MB, 1.44MB, 1.2MB, 720KB, and 360KB floppy drives.

Primary and Secondary IDE Devices

If you are setting up a SCSI hard disk, select None in the IDE Device parameters (see your SCSI card manual for more details). To install an IDE device, select the device to configure and press ENTER. An IDE Device submenu will appear (see Figure 4-3).

Numlock

Setting this to ON activates Numlock upon boot. Setting this to Auto (default) activates Numlock if the BIOS detects a numeric keyboard. It may also be set to OFF.

External Cache

This selection allows you to enable the external memory cache. For optimal performance, select Enabled.

Video BIOS

The Video BIOS category allows you to Shadow or Shadow & Cache the video BIOS. Choosing Shadowed & Cached (default) caches the shadowed video BIOS for even higher performance. Choosing Shadowed copies the video BIOS into RAM for faster execution. To disable the Video BIOS category, select Disabled.

System BIOS

The System BIOS category allows you to Shadow or Shadow & Cache the system BIOS. Choosing Shadowed & Cached (default) caches the shadowed system BIOS for even higher performance. Choosing Shadowed copies the system BIOS into RAM for faster execution. To disable the System BIOS category, select Disabled.

System Memory

The System Memory category identifies the size of the base memory. It cannot be changed.

Extended Memory

The Extended Memory category automatically detects the amount of memory installed above the amount in the System Memory category. Because the BIOS automatically calculates the amount of memory installed in your system, you cannot change this category without adding or removing memory.

Section 4: The BIOS Setup Utility

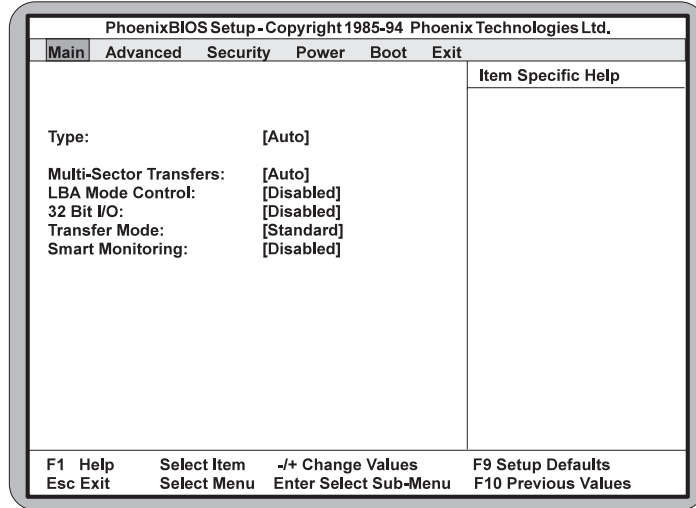

Figure 4-3: IDE Device Submenu

Type

This category selects the drive type installed in the system. The options are Auto (default), 1-39, User and None. If Autotype Fixed Disk does not find your drive's parameters, fill this information in manually under the User category. This information may be in the manual which came with your system. If not, contact your dealer or the hard drive manufacturer to fill in this category. If you are using a SCSI hard drive, select None and refer to the documentation which came with the SCSI adapter.

Multiple-Sector Transfers

This category determines the number of sectors per block for multiple sector transfers. The options are Disabled (default), 2 Sectors, 4 Sectors, 8 Sectors and 16 Sectors.

LBA Mode Control

Enabling this selection causes LBA (Logical Block Addressing) to be used in place of Cylinders, Heads and Sectors. The default setting is Disabled.

32-Bit I/O

This category allows you to enable the 32-bit I/O function of the PCI IDE controller. Select Disabled if your drive will not run at this speed. The default setting is Disabled.

Transfer Mode

This category sets the transfer speeds for IDE devices. The Standard option is the default setting. The Fast PIO 1, Fast PIO 2, Fast PIO 3 and Fast PIO 4 options are for higher speed devices.

Smart Monitoring

This feature will monitor your hard drive and report any problems detected. The default setting cannot be changed.

Setting the Advanced Screen

To move to the Advanced screen, use the left and right arrow keys <<-/->> keys until you see the screen below.

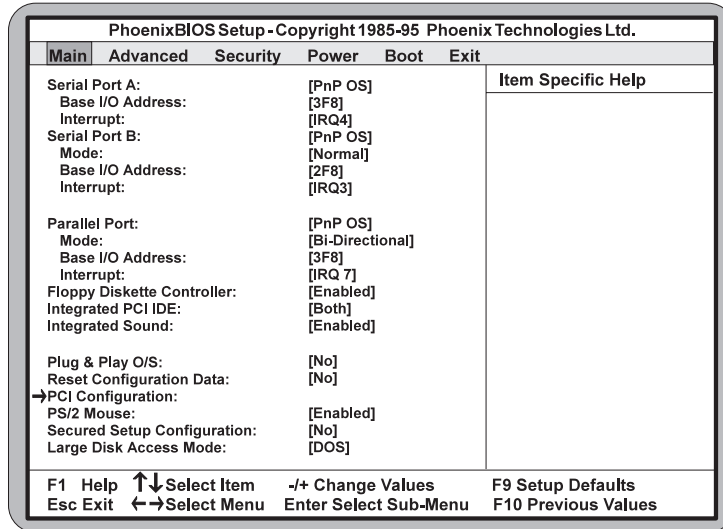

Figure 4-4: Advanced Screen

Serial Port A

Serial Port A may be configured using the following options: Disabled (No configuration), Enabled (User configuration), Auto (BIOS configuration) and PnP O/S (O/S configuration).

Serial Port B

Serial Port B may be configured using the following options: Disabled (No configuration), Enabled (User configuration), Auto (BIOS configuration) and PnP O/S (O/S configuration).

Parallel Port

The parallel port may be configured using the following options: Disabled (No configuration), Enabled (User configuration), Auto (BIOS configuration) and PnP O/S (O/S configuration).

Floppy Disk Controller

The selection allows you to enable or disable the floppy disk controller.

Integrated PCI IDE

Enables or disables the integrated Local Bus IDE adapter. The IDE controller may be set for Primary, Both (default) or Disabled.

Integrated Sound

Enables or disables the integrated sound interface. The default setting is Enabled.

Plug & Play O/S

This selection, when set to Yes, allows the system to work with a Plug and Play operating system such as Windows 95. The default setting is No.

Reset Configuration Data

Select Yes to reset Extended System Configuration Data (ESCD) when you exit Setup. This selection allows the PnP BIOS to detect your PCI and ISA PnP devices and reallocate resources to them. The default setting is No.

PCI Configuration

Use this selection for additional setup menus to configure PCI devices.

Section 4: The BIOS Setup Utility

PS/2 Mouse

When disabled, this selection prevents the PS/2 mouse from functioning and frees up IRQ12. Selecting Enabled (default) allows the operating system to determine whether to enable or disable the mouse.

Secured Setup Configuration

Select Yes if you want the system settings to be secured from change by a Plug and Play operating system. The default setting is No.

Large Disk Access Mode

If you are using a DOS operating system (MS-DOS, Novell DOS or PC-DOS), set to DOS (default). If you are using anything else, set to OTHER.

Security Screen

The Security screen (Figure 4-5) controls access to the computer. The security screen allows for settings of two passwords. The Supervisor Password allows access to the system and Setup. The User Password allows access to the system, but not to all Setup features.

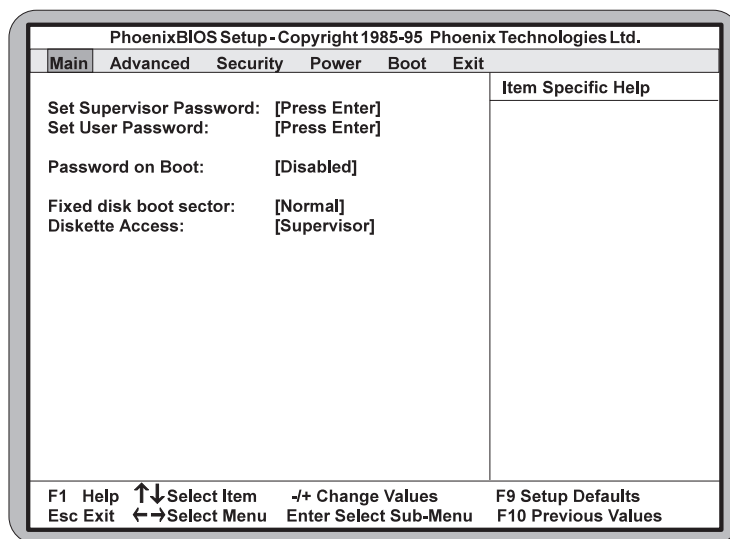

Figure 4-5: Security Setup Screen

Set Supervisor Password

This selection controls access to the Setup utility. Press the ENTER key to enter the Supervisor Password submenu. The screen on the following page appears.

Section 4: The BIOS Setup Utility

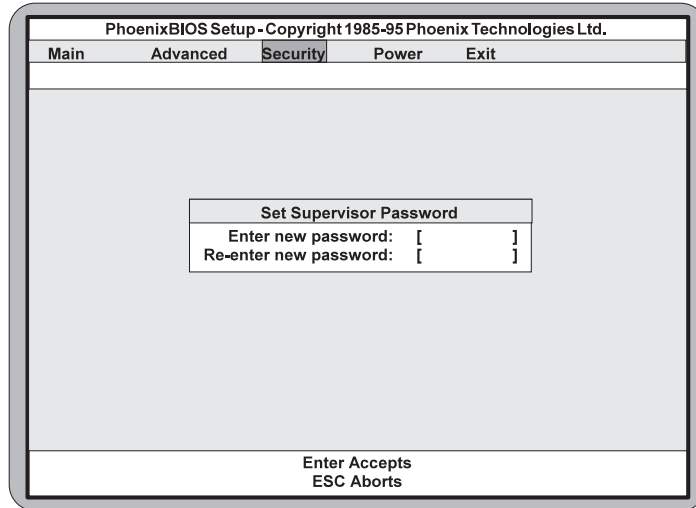

Figure 4-6: Supervisor Password Submenu

Type the password and press the ENTER key. Retype the password and press the ENTER key again. Write down the password somewhere safe so it will not be forgotten. The password may be disabled by setting the new password to nothing (pressing the ENTER key without first typing a password).

WARNING: If you forget the Supervisor Password, it cannot be disabled without discharging the CMOS.

Set User Password

This selection controls access to the Setup utility. Follow the same procedure used to set the Supervisor Password.

NOTE: After a password is entered, it is saved immediately. All other changes may still be discarded (see Exit Screen).

Password on Boot

When enabled, the system requires a password upon power up. Either the Supervisor or User Password may be entered.

Fixed Disk Boot Sector

This selection allows the boot sector of the fixed disk to be write protected. The default setting is Normal. When set for Write Protected, it serves as a form of virus protection. If the passwords are enabled, this option may only be changed by the supervisor.

Diskette Access

This selection allows floppy disk access with an option of the supervisor or user. Selecting Supervisor (default) gives floppy disk access to the supervisor only. Selecting User gives floppy disk access to both the user *and* the supervisor. If the passwords are enabled, this option may only be changed by the supervisor.

Power Screen

The Power Screen controls the power management functions of the system. To move to the Power Screen, use the left and right arrow <←/→> keys until it appears (Figure 4-7). To move between the categories, use the up and down arrow keys <↑/↓>.

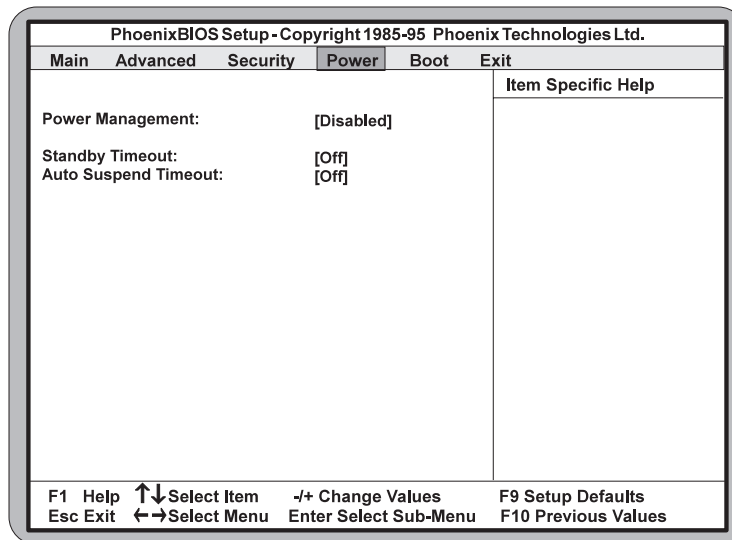

Figure 4-7: Power Screen

Power Management

This selection allows you to change the system power management settings. Maximum Power Savings conserves the greatest amount of system power. Maximum Performance conserves power but allows greatest system performance. To alter these settings, choose Customize. To turn off power management, choose Disabled (default).

Standby Timeout

The Standby Timeout selection sets the amount of time that elapses for the system to enter Standby Mode. Standby

Section 4: The BIOS Setup Utility

Mode turns off various devices in the system, including the display screen, until you start using the system again. The options are Off (default), 1 min., 2 min., 4 min., 6 min., 80 min., 12 min. or 16 min.

Auto Suspend Timeout

The Standby Timeout selection sets the amount of time that elapses for the system to enter Suspend Mode. The options are Off (default), 5 min., 10 min., 15 min., 20 min., 30 min., 40 min. or 60 min. Before making changes, "Customized" must be selected in the Power Management Mode selection.

Boot Screen

The Boot screen allows you to configure the power-up system configuration settings.

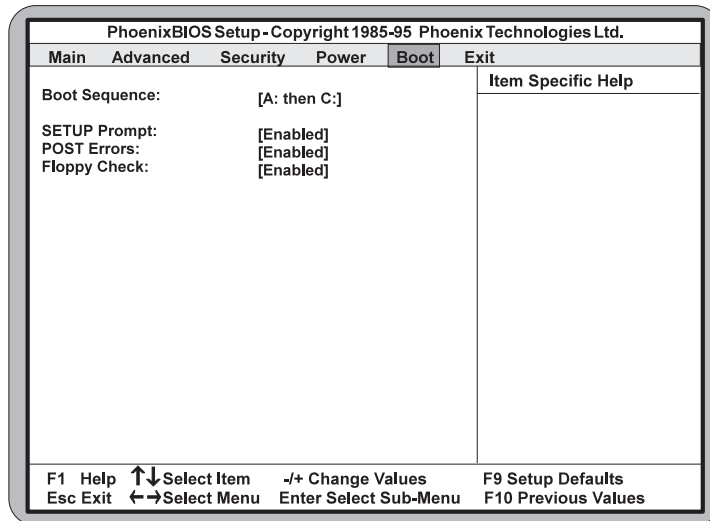

Figure 4-8: Boot Screen

Boot Sequence

This selection will read the diskette drive (default) and the hard drive in sequence on boot.

Setup Prompt

If this selection is enabled, the message "Press F2 to enter Setup" is displayed on boot. The default setting is Enabled.

POST Errors

If this selection is enabled (default) and an error occurs on boot, the BIOS will display a SETUP entry or resume prompt. If this selection is disabled, the system will always attempt to boot.

Floppy Check

This selection checks for the existence of a floppy drive.
The default setting is Enabled.

Section 4: The BIOS Setup Utility

Exit Screen

After you complete configuring the BIOS, select the Exit screen.

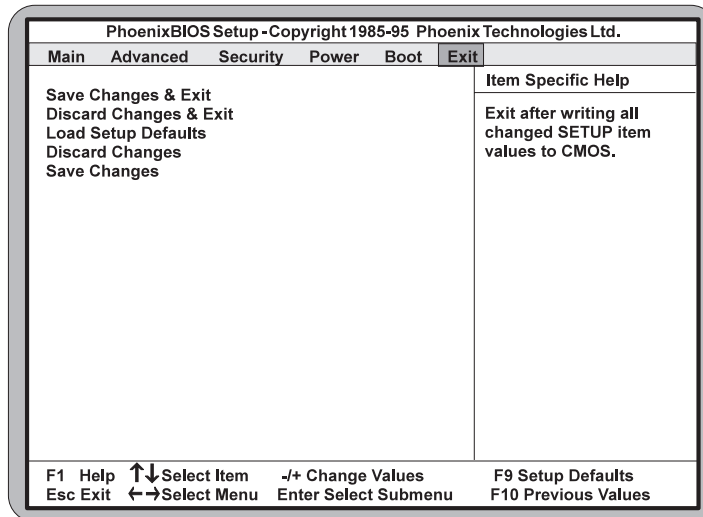

Figure 4-9: Exit Screen

Choose "Save Changes and Exit" and reboot the computer. Your computer is ready for use.

Section

5

Installing Sound Device Drivers

This section explains how to install the sound drivers necessary to utilize the onboard sound support. Prior to installing any drivers, follow the instructions in Section 3 on how to install a CD-ROM drive and how to connect external sound devices.

About Device Drivers

Device drivers are necessary for the computer system to communicate with devices such as CD-ROM drives, sound controllers, graphics adapters or devices that are not natively supported by the system BIOS. Once started, device drivers remain active in the background of the computer system. Usually a device driver is added to the CONFIG.SYS file, the AUTOEXEC.BAT file or both.

Installing the Sound Drivers

Once you have connected your external sound devices, you can install the sound drivers. NOTE: If you are installing a CD-ROM drive, it is recommended you install it before setting up the sound devices. See Installing a CD-ROM Drive in Section 3.

1. Follow the instructions in Section 3 on connecting external sound devices.
2. If you previously installed another sound card, remove it and all associated files from your AUTOEXEC.BAT and CONFIG.SYS files. If you are using Windows 3.1x, you must also remove all associated files from the WIN.INI and SYSTEM.INI files. (For more information, please contact the sound driver manufacturer.)
3. Start your computer system.
4. Insert the sound driver disk into your floppy drive.
5. If you are using Windows 3.1x, go to the Program Manager File menu, click on Run and type A:\SETUP.
6. If you are using Windows 95, refer to the Windows 95 user's manual for instructions on how to install sound drivers.
7. If you are using OS/2, refer to the README file on the OS/2 disk for instructions on how to install sound drivers.
8. Once the software is copied, the install program automatically updates the system files.

Appendix ***Technical Information***

A

Specifications

Part Number:	09-00264-01
Processor:	Single ZIF socket 8 Intel Pentium Pro processor 150, 166, 180 and 200MHz processors. VRM header to supply CPU-specific voltages.
Chipset:	Intel 440FX PCIset. Intel PIIX 3. SMC FDC37C93X Ultra I/O chip
CPU Clock Select:	Frequency synthesizer chip. Support for 60 and 66MHz CPU bus
Form Factor:	ATX footprint
Expansion:	Three 32-bit PCI slots Two 16-bit ISA slots (One shared PCI/ISA slot)
BIOS:	Phoenix 4.0X Plug and Play BIOS on 1MB Flash. Auto-detection of memory size Auto-detection of EDO memory Auto-configuration of IDE hard disk types. BIOS supports PIIX3 Bus Master IDE
RAM Capacity:	Maximum memory - 384MB Supports EDO memory
Keyboard/Mouse:	PS/2 compatible.
Internal Cache:	16K on-chip data cache (write back)

Appendix A: Technical Information

	256K/512K Level 2 cache in CPU package.
Onboard Sound:	16-bit sound controller based on Creative Labs Vibra 16C chipset. Sound Blaster Compatible 16-bit stereo Wavetable upgradeable Header for audio/telephony interface
I/O Ports:	Two high speed serial ports (16550 compatible) Enhanced Parallel Port with ECP and EPP support Infrared support for IrDA and ASK-IR Two USB ports for desktop peripheral expansion
Floppy Port:	Supports two floppy drives (2.88MB, 1.44MB, 1.2MB, 720K, 360K).
PCI IDE Ports:	Supports up to four IDE devices Mode 4 Enhanced IDE with Bus Mastering Multiple sector transfer support Auto detection of add-in IDE board

Environmental Specifications

The environment in which the M6Mi is located is critical. Micronics recommends the following environmental specifications:

Temperature Range

Operating: 50 to 104 degrees Fahrenheit (10 to 40 degrees Celsius).
Non -Operating: 50 to 140 degrees Fahrenheit (10 to 60 degrees Celsius).
Shipping: -22 to 140 degrees Fahrenheit (-30 to 60 degrees Celsius).

Relative Humidity

Operating: 20% to 80%.
Non-Operating: 5% to 90%.

Battery Disposal

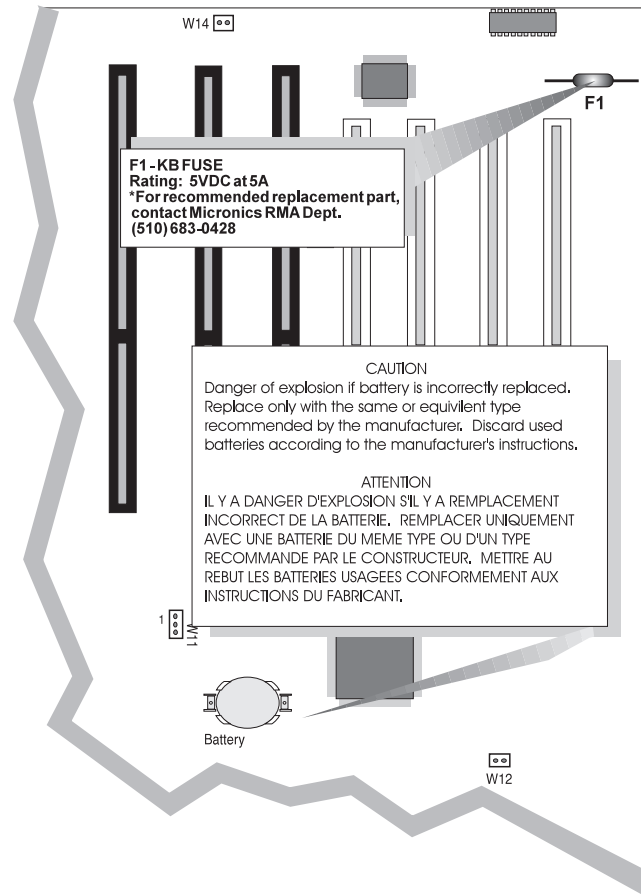

WARNING:

Please do not open battery, dispose of in fire, recharge, put in backwards or mix with used or other battery types. The battery may explode or leak and cause personal injury.

Support and Information Services

Micronics offers a variety of support and information services to help you get the most from your product. The following services are available:

- ▲ Technical Support
- ▲ Electronic Bulletin Board Service (BBS)
- ▲ Return Materials Authorization (RMA)
- ▲ Fax-On-Demand
- ▲ World Wide Web
- ▲ Customer Service

Refer to Table A-1 for details on these services.

Technical Support

If you need technical assistance, our Technical Support Engineers will be glad to help you. You can contact us via telephone, fax or BBS. Before calling Technical Support please have the following information ready:

- The model name and 09 part number of your Micronics product.
- Your computer information such as CPU type, operating system, amount of installed memory and other peripherals installed in your computer.
- Try to call from the location of your computer.

NOTE: For Return Material Authorization purposes, please keep a copy of your product receipt.

Appendix A: Technical Information

Service	Hours	Country	Telephone Number
Technical Support - Live phone help from Technical Support Engineers	M-F: 7:00am to 5:00pm (PST)	USA France UK	(510) 661-3000 (510) 651-6982 (Fax) +33 (1) 45 43 56 26 +33 (1) 45 43 17 78 (Fax) +44 (1256) 844899 +44 (1256) 364222 (Fax)
Electronic Bulletin Board Service (BBS) - Information on software upgrades, new releases and other helpful information	24 hours a day 7 days a week "	USA UK	(510) 651-6837 14400 baud rate, Parity=N, Data Bits=8, Stop Bits=1 YMODEM and ZMODEM (recommended file transfer protocols) +44 (1256) 363373
RMA (Return Materials Authorization) - Return products for repair	M-F: 8:00am to 4:45pm (PST)	USA	(510) 661-3030 (510) 683-0543 (Fax)
Fax-On-Demand - Automated system for product literature, technical bulletins and other helpful information	24 hours a day 7 days a week	USA	(510) 661-3199
World Wide Web - Product information, technical support, press releases and other helpful information	24 hours a day 7 days a week "	USA Europe	http://www.micronics.com http://www.mcrni.com
Customer Service - Order Micronics and Orchid products	M-F: 8:00am to 5:00pm (PST)	USA France UK Germany Taiwan	(800) 577-0977 (510) 651-3666 (Fax) +33 (1) 45 43 56 26 +33 (1) 45 43 17 78 (Fax) +44 (1256) 479 898 +44 (1256) 364222 (Fax) +49 (89) 58 09 82 55 +49 (89) 58 09 82 25 (Fax) +886 2 918 5005 +886 2 911 5472 (Fax)

Table A-1: Support and Information Services

Appendix A: Technical Information

Appendix ***POST Messages***

B

The following table lists the Power On Self Test (POST) messages, possible causes and solutions.

Message	Possible Cause	Solution
DISKETTE DRIVE A FAILURE	Drive A failed or is missing.	Check Setup and cable connections.
DISKETTE DRIVE B FAILURE	Drive B failed or is missing.	Check Setup and cable connections.
EXTENDED RAM FAILED AT OFFSET: nnnn	Extended memory not working or configured properly.	Replace defective memory.
FAILING BITS: nnnn	Memory failure in System, Extended, or Shadow memory.	Replace defective memory.
FIXED DISK X FAILURE (where X =0 or 1)	The hard disk is not configured or working properly.	Rerun SETUP and check connections, or replace hard disk.
FIXED DISK CONTROLLER FAILURE	The controller card has failed.	Check configuration and connections, or replace controller card.
INCORRECT DRIVE A TYPE	Floppy drive A: not set correctly in Setup.	Run Setup.
INCORRECT DRIVE B TYPE	Floppy drive A: not set correctly in Setup.	Run Setup.
INVALID NVRAM MEDIA TYPE	NVRAM chip is bad.	Requires repair of system board.
KEYBOARD ERROR, or KEYBOARD CONTROLLER ERROR	The keyboard or keyboard controller failed.	Check connections. You may have to replace the keyboard or controller.
KEYBOARD ERROR nn	A key is jammed or was held down during boot.	Make sure the keys are not jammed or dirty.
KEYBOARD LOCKED	Keyswitch on the front of the case is locked.	Unlock the keyswitch.

Appendix B: POST Messages

Message	Possible Cause	Solution
MONITOR TYPE DOES NOT MATCH CMOS	Monitor type not correctly identified in Setup.	Run Setup and enter correct monitor type.
OPERATING SYSTEM NOT FOUND	Operating system cannot be located on Drive C: or Drive A:	Check Setup to see if Drive A: and C: are properly configured, or put a bootable disk in Drive A:
PARITY CHECK 1 nnnn	Parity error found in the system bus.	Check Setup. Board repair may be required.
PARITY CHECK 2 nnnn	Parity error found in the I/O bus.	Check Setup. Board repair may be required.
PREVIOUS BOOT INCOMPLETE - DEFAULT CONFIGURATION USED	Previous POST did not complete successfully.	Run Setup, load default BIOS settings, make any necessary adjustments, and save the changes
REAL TIME CLOCK ERROR	Real-time clock failed BIOS test.	May require battery replacement or board repair.
SHADOW RAM FAILED AT OFFSET	Shadow RAM failed.	May require repair of system board.
SYSTEM BATTERY IS DEAD	System battery died.	Replace the system battery and run Setup to reconfigure the system.
SYSTEM CACHE ERROR - CACHE DISABLED	External (L2) cache failed BIOS test.	System will still run, but slower. Replace cache at convenience.
SYSTEM CMOS CHECKSUM BAD - RUN SETUP	System CMOS has been corrupted or modified incorrectly.	Run Setup and reconfigure the system.
SYSTEM RAM FAILED AT OFFSET: nnnn	System RAM failed.	Replace defective RAM.
SYSTEM TIMER ERROR	Timer test failed.	Requires repair of system board.

Beep and POST Codes

C

Beep codes are a series of beeps sent through the speaker which indicate a problem during the Power On Self Test (POST). If text appears on the video screen, the M6Mi has completed POST; any other tone from the speaker indicates something other than a POST error. These tones *are not* described in the tables on the following pages.

The beep error codes are a series of beeps. The duration of the beep tones are constant, but the length of the pauses between the beeps varies. For example: a 1-3-3 beep code will sound like one beep, a pause; three beeps consecutively, another pause and then three more beeps.

One beep code is often misunderstood. If a video card is not installed or is failing, the system board will generate a long-short-long-short beep code. This is often interpreted as a 1-2-1 beep code. But POST errors always vary in the length of the pause and not the duration of the beep tone.

Another way of identifying a POST error is to use a device called a POST card. This peripheral card is inserted into one of the ISA slots and has an LED (or LCD) read out showing the contents of port 80h.

The following tables list all beep codes and POST routines.

Appendix C: Beep and POST Codes

Code	Beeps	POST Routine Description
02		Verify Real Mode.
04		Get CPU type.
06		Initialize system hardware.
08		Initialize chipset registers with initial POST values.
09		Get in POST Reg.
0A		Initialize CPU registers.
0C		Initialize cache initial POST values.
0E		Initialize I/O.
0F		Initialize the localbus IDE.
10		Initialize Power Management.
11		Load alternate registers with initial POST values.
12		Jump to UserPatch0.
14		Initialize keyboard controller.
16	2-2-3	BIOS ROM checksum.
18		8254 timer initialization.
1A		8237 DMA controller initialization.
1C		Reset Programmable Interrupt Controller.
20	3-1-1	Test DRAM refresh.
22	3-1-3	Test 8742 Keyboard Controller.
24		Set ES segment register to 4 GB.
28		Autosize DRAM.
2A		Clear 512K base RAM.
2C	3-4-1	Test 512K base address lines.
2E	3-4-3	Test 512K base memory.
32		Test CPU bus-clock frequency.
34		Test CMOS RAM.
35		Initialize alternate chipset registers.
37		Reinitialize the chipset (MB only).
38		Shadow system BIOS ROM.
39		Reinitialize the cache (MB only).
3A		Autosize cache.
3C		Configure advanced chipset registers.
3D		Load alternate registers with CMOS values.
40		Set initial CPU speed.
42		Initialize interrupt vectors.
44		Initialize BIOS interrupts.
46	2-1-2-3	Check ROM copyright notice.
47		Initialize manager for PCI Option ROMs.
48		Check video configuration against CMOS.
49		Initialize PCI bus and devices.

Appendix C: Beep and POST Codes

Code	Beeps	POST Routine Description
4A		Initialize all video adapters in system.
4C		Shadow video BIOS ROM.
4E		Display copyright notice.
50		Display CPU type and speed.
51		Initialize EISA board.
52		Test keyboard.
54		Set key click if enabled.
56		Enable keyboard.
58	2-2-3-1	Test for unexpected interrupts.
5A		Display prompt "Press F2 to enter SETUP".
5C		Test RAM between 512 and 640k.
60		Test extended memory.
62		Test extended memory address lines.
64		Jump to UserPatch1.
66		Configure advanced cache registers.
68		Enable external and CPU caches.
6A		Display external cache size.
6C		Display shadow message.
6E		Display non-disposable segments.
70		Display error messages.
72		Check for configuration errors.
74		Test real-time clock.
76		Check for keyboard errors.
7C		Set up hardware interrupt vectors.
7E		Test coprocessor if present.
80		Disable onboard I/O ports.
82		Detect and install external RS232 ports.
84		Detect and install external parallel ports.
86		Re-initialize on-board I/O ports.
88		Initialize BIOSData Area.
8A		Initialize Extended BIOS Data Area.
8C		Initialize floppy controller.
90		Initialize hard-disk controller.
91		Initialize localbus hard-disk controller.
92		Jump to UserPatch2.
93		Build MPTABLE for multi-processor boards.
94		Disable A20 address line.
96		Clear huge ES segment register.
98		Search for option ROMs.
9A		Shadow option ROMs.

Appendix C: Beep and POST Codes

Code	Beeps	POST Routine Description
9C		Set up Power Management.
9E		Enable hardware interrupts.
A0		Set time of day.
A2		Check key lock.
A4		Initialize typematic rate.
A8		Erase F2 prompt.
AA		Scan for F2 keystroke.
AC		Enter SETUP.
AE		Clear in-POST flag.
B0		Check for errors.
B2		POST done - prepare to boot operating system.
B4		One beep.
B6		Check password (optional).
B8		Clear global descriptor table.
BC		Clear parity checkers.
BE		Clear screen (optional).
BF		Check virus and backup reminders.
C0		Try to boot with INT 19.
D0		Interrupt handler error.
D2		Unknown interrupt error.
D4		Pending Interrupt.
D6		Initialize option ROM error.
D8		Shutdown error.
DA		Extended Block Move.
DC		Shutdown 10 error.
		The following are for boot block in Flash ROM:
E2		Initialize the chipset.
E3		Initialize refresh counter.
E4		Check for Forced Flash.
E5		Check HW status of ROM.
E6		BIOS ROM is OK.
E7		Do a complete RAM test.
E8		Do OEM initialization.
E9		Initialize interrupt controller.
EA		Read in the bootstrap code.
EB		Initialize all vectors.
EC		Boot the Flash program.
ED		Initialize the boot device.
EE		Boot code was read OK.

Appendix **Hard Disk Drive Types**

D

The following table lists the hard disk types supported by the M6Mi.

Type	Cylinders	Heads	Write Precomp	Sectors	Size
1	306	4	128	17	10
2	615	4	300	17	21
3	615	6	300	17	32
4	940	8	512	17	65
5	940	6	512	17	99
6	615	4	none	17	21
7	462	8	256	17	32
8	733	5	none	17	31
9	900	15	none	17	117
10	820	3	none	17	21
11	855	5	none	17	37
12	855	7	none	17	52
13	306	8	128	17	21
14	733	7	none	17	44
15	N/A	N/A	N/A	N/A	N/A
16	612	4	0	17	21
17	977	5	300	17	42
18	977	7	none	17	59
19	1024	7	512	17	62
20	733	5	300	17	31
21	733	7	300	17	94
22	733	5	300	17	31
23	306	4	0	17	10
24	612	4	305	17	21
25	612	2	300	17	10
26	614	4	none	17	21
27	820	6	none	17	42
28	977	5	none	17	42
29	1218	15	none	36	336
30	1224	15	none	17	159

Appendix D: Hard Disk Drive Types

Type	Cylinders	Heads	Write Precomp	Sectors	Size
31	823	10	512	17	71
32	809	6	128	17	42
33	830	7	none	17	50
34	830	10	none	17	72
35	1024	5	none	17	44
36	1024	8	none	17	71
37	615	8	128	17	42
38	1024	8	none	26	109
39	925	9	none	17	72

Appendix ***Updating the System BIOS***

E

The Micronics system boards are designed so that the BIOS can be reprogrammed using a BIOS file. You can easily FLASH a BIOS by following the steps below:

- 1) After downloading the appropriate BIOS file from our BBS or Website, extract it to a bootable MS-DOS 6.X diskette.
- 2) Reboot your system with the MS-DOS 6.X diskette in the A: drive. To make sure a clean DOS environment is loaded, press the F5 key while “Starting MS-DOS” is displayed. After the system has rebooted, the cursor will appear at the A:> prompt.
- 3) Now you can run the FLASH utility. The filename will be either “FSH” (or FSH20, FSH20G, etc.) or “PHLASH.” Type this filename at the A:> prompt (but don’t include its extension), followed by a space and the BIOS ROM image’s filename. This file will be included in the download and has a file length of about 131K. For example, to update the M6Mi to BIOS version 01, you would type:

PHLASH M6Mi_01.ROM [ENTER]

- 4) Once the FLASH process has begun, select [Y]es, if prompted, to allow auto-sensing of the part (the FLASH chip itself).
- 5) After the update process has completed and the system reboots, verify that the new BIOS version appears on-screen. If you have problems during this process, or if you have questions about the procedure, please call Technical Support.

NOTE: If the BIOS is somehow erased or does not seem to accept the upgrade, you can purchase a new BIOS from MicroNiche Information Systems (800-733-9188). There is a \$30.00 fee plus shipping charges for this service. (Price and availability subject to change.)



If you encounter any problems during this process, or if you have questions about the procedure, please call Technical Support.

Appendix E: Updating the System BIOS

If you prefer to send your system board in for the upgrade, the RMA department offers this service free of charge if your system board is under warranty.

Appendix **Limited Warranty**

F

Except as described below, Micronics warrants the products to be free from defects in material and workmanship in normal use for a period of one (1) year from date of purchase. Should any product fail to perform according to this warranty at any time during the warranty period, except as provided below, Micronics or its authorized service centers will, at Micronics' option, repair or replace the product at no additional charge.

The warranty does not cover loss or damage which occurs in shipment or which is due to: (1) improper installation or maintenance, misuse, neglect or any cause other than ordinary commercial application, including without limitation, accidents or acts of God; (2) adjustment, repair, or modification by other than a Micronics authorized service center; (3) improper environment, excessive or inadequate heating or air conditioning, or electrical power failures, surges or other irregularities; (4) any statement about the product other than those set forth in this warranty; or (5) nonconformity to models or samples shown to the purchaser. Any models or samples were for the sole purpose of suggesting the character of the product and are not intended to form the basis of the bargain.

A receipt or copy of the invoice with the date of purchase from a Micronics reseller is required before any warranty service can be rendered. Service can be obtained by calling Micronics for a Return Merchandise Authorization (RMA) Number.

The RMA Number should be prominently displayed on the outside of the shipping carton of the returned product. Returned product should be shipped prepaid or hand carried to Micronics. The purchaser assumes risk of loss or damage in transit, and unless otherwise agreed to in writing by Micronics, will pay inbound shipping charges.

The exclusive remedy of the purchaser under this warranty above will be repair or replace at Micronics' option, but if for

Appendix F: Warranties and Notices

any reason that remedy should fail of its essential purpose, the exclusive remedy of the purchaser shall then be actual damages up to amounts paid for the defective product by the purchaser. This limited warranty shall be deemed to “fail of its essential purpose” if, after repeated efforts, Micronics is unable to make the product operate as warranted. Micronics’ liability for damages to the purchaser for any cause whatsoever; regardless of the form of action and whether in contract or in tort, shall be limited to the purchase price in effect when the cause of action arose for the product that is the basis of the claim.

Micronics will not be liable for any lost profits or any indirect, special incidental or consequential damages in connection with the product, even if Micronics has been advised of the possibility of such damages.

Micronics makes no warranties or representations as to performance of products or as to service to distributor or to any person, except as set forth in Micronics; limited warranty accompanying delivery of product.

Micronics disclaims all other warranties whether oral, written, expressed, or implied, including without limitation, the warranties of design, merchantability, or fitness for a particular purpose, if applicable, or arising from a course of dealing, usage or trade practice.

Non-Warranty Service

After the one year warranty service is no longer in effect, repair service is still available for Micronics products. For more information, contact Micronics’ RMA department at (510) 661-3030. The RMA department is open between 8:30 A.M. and 4:45 P.M. Pacific Standard Time.

FCC Statement

This equipment has been tested and found to comply within the limits for a Class B digital device, pursuant to Part 15 of the FCC Rules. These limits are designed to provide reasonable protection against harmful interference in a residential installation. This equipment generates, uses and can radiate radio frequency energy and, if not used in accordance with the instructions, may cause harmful interference to radio communications. Interference to radio or television reception can be determined by turning the equipment off and on. You are encouraged to try to correct the interference by one or more of the following measures:

- ▲ Reorient the receiving antenna.
- ▲ Increase the separation between the equipment and the receiver.
- ▲ Connect the equipment into an outlet on a circuit different from that to which the receiver is connected.
- ▲ Consult your dealer or an experienced radio/TV technician for help.

To meet FCC requirements, shielded cables are required.

NOTE: Changes or modifications not expressly approved by Micronics could void your authority to operate the equipment.

Declaration of Conformity

Application of Council Directives 89/336/EEC. Standards to which the conformity is declared:

EN55022 EN50082-1

Manufacturer's Name: Micronics Computers, Inc.
Manufacturers Address: 221 Warren Avenue
Fremont, California 94539
USA
Tel: (510) 651-2300
Fax: (510) 651-9450
Type of Equipment: Pentium Pro 150/166/200
Mid Tower Personal Computer
Model Name: M6Mi
Tested by: Rockford Engineering Services, Inc.
9959 Calaveras Road
Sunol, CA. 94586-0543
USA
Tel: (510) 862-2944
Fax: (510) 862-9013
Test Engineers John Y. Chan/Micronics
(EN55022)
Paramjeet Singh/RES
(EN50082-1)

I, the undersigned, hereby declare that the specified equipment conforms to the directives and standards listed above.



Ming Ming Hsu
Vice President of Engineering
May 29, 1996

Glossary

16550 UART - A high speed chip for controlling serial ports. Although unnecessary for a mouse, it is required for modems that are 14,400 baud or faster.

486DX - A type of 32-bit CPU with a built-in math-coprocessor and internal cache.

486DX2 - A 486DX CPU where the internal speed of the CPU operates at twice the external speed.

486DX4 - A 486DX CPU where the internal speed of the CPU operates at three times the external speed.

486SX - A 486DX CPU with no math-coprocessor.

ATX - A system board size measuring approximately 12" x 9.6".

Asynchronous - Operations that do not require the clocks of communicating devices to be coordinated. See Synchronous.

Bidirectional Parallel Port - A type of parallel port that can send and receive information.

BIOS - An Acronym for Basic Input/Output System. Configures the system board and provides hardware information to the operating system.

Bit - A contraction of Binary digit. The smallest unit of information in a binary number system. A bit represents a choice between either zero or one.

Boot - To start up the computer and load the operating system software. See cold boot and warm boot.

Bus - A group of electronic paths used to send data between parts of the system. On a system board, the bus connects the peripheral cards with the microprocessor via the expansion slots.

Bus Mastering - The ability of an peripheral card to control the bus without requiring intervention of the CPU.

Byte - A group of adjacent bits treated as a unit. Eight bits are typically considered one byte. Also called a character.

Cache - A process where information is copied from the slower memory (DRAM) to the faster memory (SRAM). Information that is likely to be read or edited is stored in the cache providing significant performance increases.

Cache Hit - The percentage of request for data from memory that can be served from the cache.

Cache Miss - A memory access which cannot be supplied from cache.

Cold Boot - Starting the computer by turning on the power or pressing the RESET button. A cold boot makes the processor execute all of the diagnostics. See boot and warm boot.

Glossary

CPU - An acronym for Central Processing Unit. A CPU performs arithmetic calculations, makes logical decisions, and directs the operation of the computer in conjunction with the operating system.

Disk Drive - A hardware device which provides for the storage of data on diskettes or hard metal disks that have a magnetic coating. A disk drive functions by spinning at high speed while moving a device called the read/write head across the disk's surface in order to read or write data in magnetic code.

DRAM - An acronym for Dynamic Random Access Memory. A type of memory chip that only keeps its memory if supplied with regular clock pulses and a chance to regularly refresh its data. It is slower and more cost effective than SRAM. See SRAM.

ECC - An acronym for Error Checking and Correction. ECC enables parity checking and can detect and correct memory errors on the system board.

ECP - An acronym for Extended Capabilities Port. A standard set by Hewlett Packard and Microsoft Corporation to expand the capabilities of the parallel port.

EDO Memory - An acronym for Extended Data Out. A type of DRAM with built-in cache for enhanced performance.

EISA - An acronym for Extended Industry Standard Architecture. EISA is a bus design standard which is fully backward compatible with the ISA bus. Although it is a 32-bit bus, it only runs at 8MHz. See *PCI, VESA Local Bus and ISA*.

EPP - An acronym for Enhanced Parallel Port. A standard which increases the capabilities of the parallel port.

EPROM - Acronym for Erasable Programmable Read Only Memory. A type of ROM chip that can be programmed with relatively simple tools that will retain its data until erased. It can only be erased by exposing the circuitry in the chip to ultraviolet light. See also Flash ROM.

Flash ROM - A type of ROM chip that will retain its data until erased. It can be erased or reprogrammed by supplying it with +12V of voltage. See ROM and EPROM.

Gigabyte - A disk storage capacity measurement. Approximately one thousand megabytes or 1,073,741,824 bytes.

IDE - An acronym for Integrated Device Electronics. A standard for communicating between a hard drive and a computer.

Internal Cache - Cache which is built into the CPU. See Cache.

ISA - An acronym for Industry Standard Architecture. A well-established bus standard that originated with the IBM AT. See *PCI, VESA Local Bus and EISA*.

Parallel - A form of data transmission in which the data is sent one byte at a time over several wires that each carry one byte. In parallel transmission, all the bytes arrive simultaneously, as opposed to serial transmission in which bits arrive one by one.

Parallel Port - A connection for a printer or similar peripheral. Generally, parallel ports are output only. See *Bidirectional Parallel Port and ECP*.

PCI - An acronym for Peripheral Component Interconnect. A high performance 32-bit or 64-bit bus developed by Intel Corporation. PCI is designed to be independent of the hardware architecture to ensure compatibility with future computer systems. See *EISA, VESA Local Bus and ISA*.

Pentium - A high performance 64-bit CISC processor designed and manufactured by Intel Corporation. As of this writing, Pentium is the highest performing X86 processor available.

Plug and Play - A standard developed to ensure easy installation of peripherals. Theoretically, a newly installed card will automatically configure itself and work properly without requiring jumper configuration or device drivers.

POST - An acronym for Power On Self Test. A diagnostic program that is run whenever the system is cold booted.

RAM - An acronym for Random Access Memory. A type of memory that is used as the “working memory” of a computer system. See *DRAM and SRAM*.

ROM - An acronym for Read Only Memory. A type of memory that retains its data without requiring power. Once written, it cannot be modified. See *EPROM and Flash ROM*.

Serial - A type of data transmission in which the data is sent one bit at a time over a single wire. See *Parallel*.

Serial Port - A communications port used to connect peripherals such as modems and mice.

Setup - A program that allows you to make changes to the system configuration.

Shadow RAM - A technique used to load a duplicate copy of BIOS from slower ROM into faster RAM. This enhances system performance because it provides higher access speed to the BIOS.

SIMM - An acronym for Standard Inline Memory Module. A small printed circuit board containing memory chips.

Glossary

SRAM - An acronym for Static Random Access Memory. A type of memory that can retain data without requiring a regular clock signal. Although they are faster than DRAM, they hold less data and are more expensive.

Synchronous - Protocols that require the clocks of communicating machines or devices to be coordinated.

Synchronous Cache - A type of cache that uses a clock signal to latch the inputs and the data output. This structure spreads the cache access across two or three cycles while maintaining a bandwidth of one access per cycle. Improves performance by 5-10%.

Terabyte - A measurement for very large storage capacity. One Terabyte is equivalent one-thousand gigabytes, one-million megabytes, or 1,099,511,627,766 bytes.

VESA - An acronym for Video Electronics and Standards Association.

VESA Local Bus (VL-Bus) - A high performance bus designed by VESA. A 32-bit version of the ISA bus which operates at the speed of the computer's CPU. See *PCI, EISA and ISA*.

VGA - An acronym for Video Graphics Array. A standard for monitor displays.

VRM - An acronym for Voltage Regulator Module. A power module that regulates voltage to the CPU.

Warm Boot - Restarting the system by simultaneously pressing the <Ctrl>, <Alt> and <Delete> keys.

Write-Back Cache - Upon a cache hit, the cache is updated and the main memory is not affected. Upon a cache miss, only the main memory is updated.

Write-Through Cache - Upon a cache hit, the cache and the main memory are updated. Upon a cache miss, only the main memory is updated.

Index

A

- ATX
 - Chassis - 18
 - Form Factor - 5
 - Power Supply - 18

B

- Back Panel Connections - 13
- Battery Disposal - 51
- Beep and POST Codes - 57
- BIOS
 - Configuration - 29
 - Setup - 29
- Bulletin Board System (BBS) - 53

C

- Configuring the M6Mi - 11

D

- Diagram (M6Mi) - 12

E

- Extended Data Out (EDO) Memory - 17, 19
- Environmental Specifications - 50
- Error Checking (ECC) - 17, 19

Index

F

Fast Page Mode (FPM) Memory - 17, 19

H

Hard Disk Drive Types - 61

Help

Bulletin Board System (BBS) - 53

Telephone Numbers - 53

Troubleshooting - 55, 57

I

Installation

CD-ROM Drive - 26

CPU - 23

Installing your M6Mi - 17

ISA Peripheral Card - 25

PCI Peripheral Card - 24

Quick Installation - 9

Sound Drivers - 48

J

Jumper Settings - 13

M

M6Mi Back Panel Connections - 13

M6Mi System Board Diagram - 12

Memory

Configurations - 20

Installing - 22

Removing - 22
Supported - 17, 19

O

Online Services - 53

P

POST Messages - 55

S

Sound Option - 27
Specifications - 49
System BIOS
 Configuring - 29
 Updating - 63

T

Technical Specifications - 49
Technical Support - 52
Telephony Option - 28
Troubleshooting - 55, 57

U

Updating the System BIOS - 63
Utility Programs
 Advanced Screen - 36
 BIOS Setup - 29
 Boot Screen - 44
 Exit Screen - 46

Index

Main Screen - 31
Power Screen - 42
Security Screen - 39

W

World Wide Web - 53