

---

***D6-IN Pentium Pro***  
***PCI/ISA***  
*System Board Manual*

**MICRONICS**  
COMPUTERS INC.

Document Number: 06-00286-01, Rev. 2A  
September 1996  
221 Warren Ave., Fremont, CA 94539-7085

---

## **Copyright Notices**

Copyright © 1996 Micronics Computers, Inc. The information contained in the D6-IN PCI/ISA system board manual has been carefully checked and is believed to be accurate. Micronics assumes no responsibility for any inaccuracies that may be contained in this document. Micronics makes no commitments to update or to keep the information in this manual at a current level when changes are made to the product.

Micronics reserves the right to make improvements to this document and/or product at any time and without notice. All Rights Reserved. No part of this document may be photocopied, reproduced, translated, or reduced to any medium or machine form without prior, written consent from Micronics.

## **Portions of the Manual**

Portions of this manual were copied (with permission) from Phoenix Technologies, Ltd. and Micro Computer Systems, Inc. All rights reserved.

## **Trademarks**

IBM is a registered trademark of International Business Machines. Microsoft and Windows are registered trademarks of Microsoft Corporation. Intel and PCI are registered trademarks of Intel Corporation. All other product names mentioned herein are used for identification purposes only and may be the trademarks of their respective companies.

---

## ***Table of Contents***

<b>Introduction</b>	5
Features	6
Software Compatibility	7
Before You Begin	8
<b>Chapter 1 - Quick Installation</b>	9
Installing the D6-IN	9
<b>Chapter 2 - Configuring the D6-IN</b>	11
Static Electricity	11
Office Environment	11
D6-IN System Board	12
Jumper Settings	13
<b>Chapter 3 - Installing the D6-IN</b>	15
Introduction	15
System Memory Support	15
Installing the D6-IN	16
Tools Required	16
Equipment Required	16
System Memory	17
SIMMs Supported	17
Upgrading Rules	17
Mixing EDO and FPM Memory	18
Memory Configurations	19
Installing the SIMMs	21
Removing SIMMs	21
Installing a CPU	22
Installing a PCI Peripheral Card	23
Installing an ISA Peripheral Card	24

---

<b>Chapter 4 - The BIOS Setup Utility</b>	25
Configuration	25
Initial Bootup	25
Setup	25
Running the Setup Procedure	27
Setting the Main Screen	27
Setting the Advanced Screen	32
Security Screen	35
Power Screen	38
Boot Screen	41
Exit Screen	42
<b>Appendix A - Technical Information</b>	43
Specifications	43
Environmental Specifications	44
Temperature Range	44
Relative Humidity	44
Battery Disposal	45
Technical Support	46
Online Services	47
<b>Appendix B - Post Messages</b>	49
<b>Appendix C - Beep and POST Codes</b>	51
<b>Appendix D - Hard Disk Drive Types</b>	55
<b>Appendix E - Updating the System BIOS</b>	57

---

<b>Appendix F - Warranties and Notices</b>	59
Limited Warranty	59
FCC Statement	61
Declaration of Conformity	62
<b>Glossary</b>	63
<b>Index</b>	67

---

### ***List of Figures***

Figure 1.1: Power-Up Screen	10
Figure 2.1: D6-IN System Board	12
Figure 3.1: Installing a 72-Pin SIMM	21
Figure 3.2: Installing a PCI Card	23
Figure 3.3: Installing an ISA Peripheral Card	24
Figure 4.1: Power-Up Screen	26
Figure 4.2: CMOS Main Screen	27
Figure 4.3: IDE Device Submenu	30
Figure 4.4: Advanced Screen	32
Figure 4.5: Security Setup Screen	35
Figure 4.6: Supervisor Password Submenu	36
Figure 4.7: Power Screen	38
Figure 4.8: Boot Screen	41
Figure 4.9: Exit Screen	42

### ***List of Tables***

Table 2.1: CPU Speed Selection	13
Table 2.2: Real-time Clock Selection	13
Table 2.3: Case and Peripheral Connections	14
Table 3.1: Memory Configurations	19

## ***Introduction***

Thank you for choosing the D6-IN system board. The high-performance D6-IN supports the most advanced Pentium® Pro microprocessor technology for demanding workstation needs.

Based on the Intel 440FX PCIsset, the D6-IN provides the speed and performance necessary to address the most intensive computational applications. Enhanced PCI throughput, Mode 4 IDE and optional support of Universal Serial Bus (USB), make this board state-of-the-art. The USB interface has a maximum bandwidth of 12Mbps and can connect as many as 127 devices to a host system. USB supports both standard devices that operate at the full 12Mbps rate and low-end devices that use only a 1.5Mbps subchannel.

The D6-IN comes with many features. These include support for Extended Data Out (EDO) and Fast Page Mode (FPM) DRAM memory, Error Checking and Correction (ECC) and the Phoenix Plug and Play BIOS.

Micronics builds all products to exacting standards, using the highest quality components available. We are proud to provide this system board and believe you will be pleased with your purchase.

## Features

The D6-IN includes the following features:

- ④ Single ZIF socket 8  
Intel Pentium Pro 150-200MHz  
Integrated Voltage Regulator  
Auto-detection of CPU voltage
- ④ Intel 440FX PCI chipset  
Intel PIIX 3  
SMC FDC37C93X Ultra I/O chip
- ④ Four 32-bit PCI slots  
Three 16-bit ISA slots  
One is a shared PCI/ISA slot
- ④ 16K Level 1 Write Back on the CPU chip  
256K or 512K Level 2 cache in CPU
- ④ Six 32/36-bit 72-pin SIMM sockets  
Support for up to 384MB of onboard system memory  
Supports FPM and EDO memory  
ECC support via chipset (36-bit SIMM)
- ④ Primary and Secondary 40-pin IDE connectors
- ④ Mode 4 enhanced IDE
- ④ Two Universal Serial Bus (USB) ports for desktop peripheral expansion (optional)
- ④ Floppy controller for two floppy drives (supports 2.88MB, 1.44MB, 1.2MB, 720K or 360K floppy drives)
- ④ Two high speed NS16550 compatible serial ports
- ④ AT style keyboard and mouse connectors (PS/2 style optional)
- ④ Bi-directional parallel port (ECP and EPP compatible)
- ④ One Infrared port (IrDA compatible)
- ④ Field upgradeable Flash Phoenix BIOS

## **Software Compatibility**

The D6-IN system board has been thoroughly tested for compatibility with a variety of operating systems and environments, including:

- ⊞ Windows 95 and Windows NT
- ⊞ OS/2 Warp
- ⊞ SCO UNIX and Open Desktop
- ⊞ Novell Netware
- ⊞ MS-DOS 5.0 and 6.2
- ⊞ PC-DOS

## **Before You Begin**

This manual will familiarize you with the features, installation and use of your D6-IN. There are several symbols and conventions used throughout this manual to help draw your attention to a feature or to focus on important information:



When you see the Magnifying Glass, it refers to something you should take a closer look at before proceeding further.



When you see the Exclamation Mark, it gives important information on avoiding damage.

### **Common Names**

DRAM	Dynamic Random Access Memory
ECC	Error Checking and Correction
ECP	Extended Capabilities Port
EDO	Extended Data Out
EPP	Enhanced Parallel Port
FPM	Fast Page Mode
IDE	Integrated Drive Electronics
PCI	Peripheral Component Interconnect
SIMM	Single Inline Memory Module
USB	Universal Serial Bus
VRM	Voltage Regulator Module

Chapter

# 1

## Quick Installation

We know that many experienced people prefer to read as little of the documentation as possible. If this sounds like you, here's the short form to get up and running quickly.



**STATIC!**

*Before handling the D6-IN, be properly grounded by using a special wrist or ankle strap, or touch a safely grounded object.*

### Installing the D6-IN

1. Make backup copies of your installation and configuration diskettes.
2. Ground yourself to prevent damaging static discharge, then remove the D6-IN from its packaging.
3. Configure and verify the system board's jumper settings (refer to Jumper Settings in Chapter 2).
4. Install the CPU and the system memory (refer to Chapter 3).
5. Install the system board into the chassis and make all necessary case connections.
6. Install any ISA and PCI add-on peripherals (refer to Chapter 3).
7. Now you can connect any optional devices (refer to Chapter 3).
8. Turn the computer on and press the <F2> key when you see the screen in Figure 1.1.

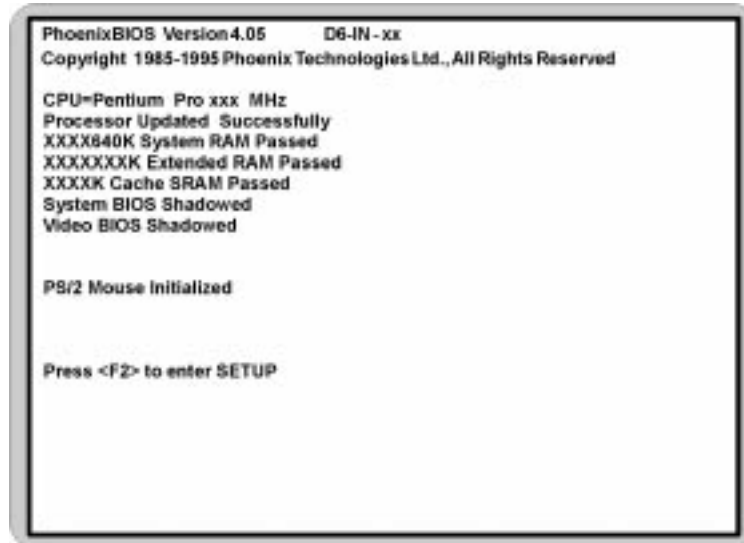

Figure 1.1: Power-Up Screen

9. Set the time and date. Adjust the BIOS settings to match your configuration. If installing an IDE drive, select the IDE device you wish to configure. Press ENTER with Autotype Fixed Disk selected and the BIOS will automatically configure the drive for you (refer to Chapter 4).
10. After you have configured the Main Setup menu, make any desired setting configurations in the Advanced and Security menu. When finished, go to the exit screen, select "Save Changes and Exit" and you are finished with the BIOS configuration (see Chapter 4).

Chapter

# 2

## ***Configuring the D6-IN***

Although the D6-IN system board is packaged in protective materials, it is important to use care while unpacking and setting up.

### **Static Electricity**

The D6-IN is shipped from the factory in an antistatic bag. To reduce the possibility of damage, it is important to neutralize any accumulated static charges on your body before handling the board.

The best way to do this is to ground yourself using a special wrist or ankle strap. If you do not have a strap, you should touch both of your hands to a safely grounded object. After you have grounded yourself, ground the D6-IN via the solder pads surrounding one of its mounting holes. Once the D6-IN is removed from its packaging, place it on top of the antistatic bag. Carefully inspect the board for damage which may have occurred during shipment.

### **Office Environment**

Make sure the finished computer system is in an area with good ventilation. The system should not be in direct sunlight, near heaters, or exposed to moisture, dust or dirt.

## D6-IN System Board

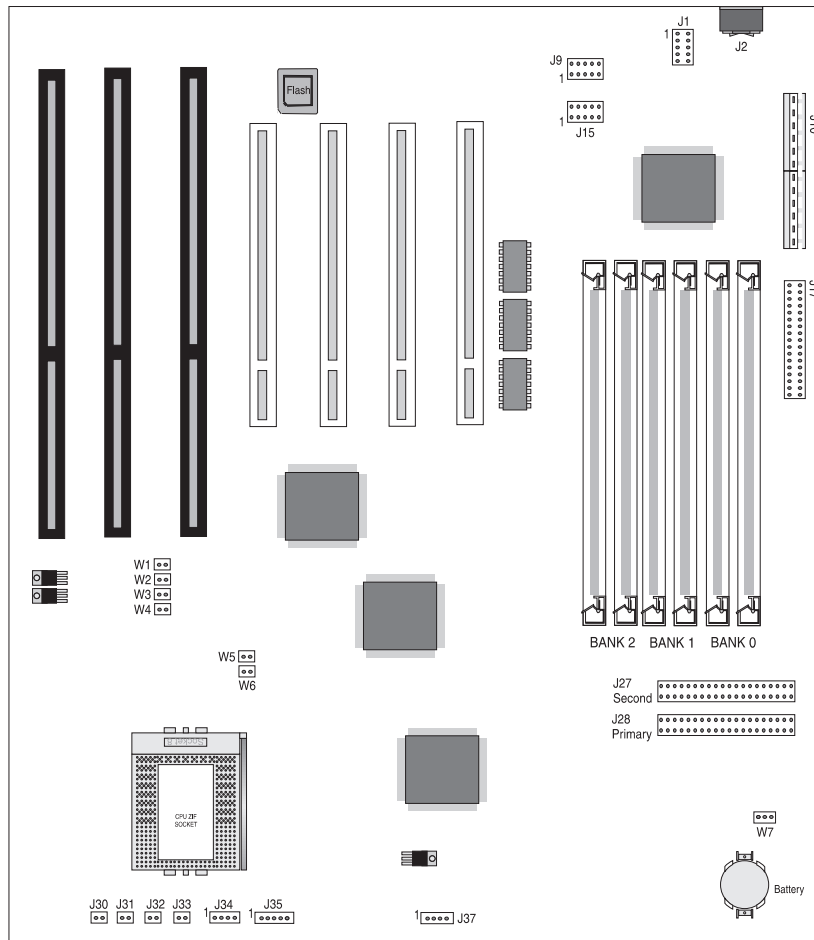

Figure 2.1: D6-IN System Board

## Jumper Settings

This section gives you the jumper settings used for the D6-IN system board.

Table 2-1: Jumper settings to select the speed of the CPU.

CPU Speed		W1	W2	W3	W4	W5	W6
150 MHz	60 x 2.5	Open	Close	Close	Close	Close	Open
166 MHz	66 x 2.5	Open	Close	Close	Close	Open	Close
180 MHz	60 x 3.0	Close	Open	Close	Close	Close	Open
200 MHz	66 x 3.0	Close	Open	Close	Close	Open	Close

Table 2-1: CPU Speed Selection

Table 2-2: Jumper settings to reset the real-time clock.

Jumper	Function	Settings
W7	Normal	1-2
	Clear CMOS	2-3

Table 2-2: Real-time Clock Selection

## Chapter 2: Configuring the D6-IN

---

Table 2-3: Case and peripheral connections.

Connector	Function	Notes
J1	External Mouse Connector	AT version
J2	Keyboard Connector	AT version
J4 & J3	PS/2 Keyboard & Mouse Connector	PS/2 version
J9	Serial Port (COM 1)	Can be disabled at the CMOS configuration screen
J10	Power Connector	
J15	Serial Port (COM 2)	Can be disabled at the CMOS configuration screen
J16	Parallel Port Connector	Can be disabled at the CMOS configuration screen
J17	Floppy Drive Connector	
J27	Secondary IDE Port	
J28	Primary IDE Port	
J30	CPU Fan	1 - +12V Power; 2 - Ground
J31	Reset Switch	1 - Ground; 2 - Reset
J32	IDE LED	1 - IDE; 2 - Positive
J33	Turbo LED	1 - Ground; 2 - Positive
J34	Speaker	1 - Speaker; 2,3 - No Connect; 4 - Positive
J35	Keylock Switch	1 - Power; 2 - No Connect; 3 - Ground; 4 - Keyboard Lock; 5 - Ground
J37	Infrared Port Connector	1 - Receive Data; 2 - Ground; 3 - Transmit Data; 4 - +5V DC

Table 2-3: Case & Peripheral Connections

Chapter

# 3

## ***Installing the D6-IN***

### **Introduction**

This chapter explains how to install the D6-IN system board, memory, CPU and peripherals.

**WARNING:** *Before installing or removing any peripherals or components, make sure you have a clear work space and that you adhere to all anti-static precautions described in Chapter 1. Micronics recommends only trained technicians install and configure the system board.*

*Damage which occurs to the board while adding or removing peripherals or components may void the warranty. If problems arise while installing peripherals, contact the computer dealer where you purchased the peripheral or Micronics' Technical Support Department.*

### **System Memory Support**

The flexibility of the D6-IN is augmented by its support for Error Checking and Correction (ECC), Extended Data Out (EDO) DRAM memory and Fast Page Mode (FPM) DRAM memory. It supports Error Checking and Correction via the chipset.

EDO memory is designed to keep data available to the processor for an extended period of time. The EDO memory support extends the performance of conventional DRAM memory. The result is an improvement in memory-access performance on the D6-IN system board.

## **Installing the D6-IN**

Installation of the D6-IN system board depends on the type of case you use. The D6-IN is a Baby AT size system board and may be installed into most cases. NOTE: If you are unfamiliar with installing a system board, Micronics highly recommends that you read the computer user's manual or contact your dealer's technical support department.

### **Tools Required**

Micronics recommends using the following tools to install the D6-IN:

- ④ Small Phillips screwdriver
- ④ Tweezers or a pair of needle-nose pliers
- ④ Tray (to hold loose screws)

### **Equipment Required**

Micronics recommends using the following equipment with the D6-IN for a typical configuration:

- ④ Chassis with standard hardware.
- ④ A high-quality power supply capable of providing continuous power within a 5 volt range. A power filter may be used with a noisy AC power source.
- ④ Standard AT mouse and compatible keyboard.
- ④ Eight ohm speaker.
- ④ Standard ribbon cables for internal connections.
- ④ Standard power cord (grounded).
- ④ Heat sink with cooling fan for CPU (required).

## System Memory

System memory devices, commonly known as SIMMs, are necessary to operate the D6-IN system board. The D6-IN has six 32/36-bit SIMM sockets for a maximum of 384 Megabytes of RAM. In addition, support is provided for Extended Data Out (EDO) DRAM memory and Fast Page Mode (FPM) DRAM memory. This section will explain the type of SIMMs supported, list the rules for adding memory to the D6-IN, give some examples of common memory configurations and show how to physically install the new SIMMs.



*For long term reliability, Micronics recommends using SIMMs with tin-plated contacts. The use of gold-plated contacts may conflict with the tin-alloy on the SIMM socket.*

### SIMMs Supported

The D6-IN supports the following types of 60 or 70ns SIMMs:

- 4MB (1MBx32/36)
- 8MB (2MBx32/36)
- 16MB (4MBx32/36)
- 32MB (8MBx32/36)
- 64MB (16MBx32/36)

### Upgrading Rules

The following is a list of rules to follow when upgrading SIMMs. If you follow these rules, your upgrade should be trouble-free:

- ④ Use 70ns or faster SIMMs.
- ④ Upgrade SIMMs one bank at a time. Each bank must contain two SIMMs of the same size and preferably from the same manufacturer. For example, to add 16MB of memory to the system board, install two 8MB SIMMs into the same bank.
- ④ When installing SIMMs, fill Bank 0, then Bank 1, then Bank 2.

### ***Chapter 3: Installing the D6-IN***

---

#### **Mixing EDO and FPM Memory**

The D6-IN can handle a combination of EDO and FPM memory. The memory will default to the speed of the slowest RAM installed.

Follow the rules below:

- ④ Install the two types of memory in separate banks. (For example, install EDO memory in Bank 0 and FPM memory in Bank 1.)
- ④ When installing SIMMs, fill Bank 0, then Bank 1, then Bank 2.



*There is no need to set any jumpers. When you reboot, the size and type of memory are automatically detected.*

## Memory Configurations

The following tables list the most common memory configurations. The memory available depends on the number of SIMMs installed.

Memory	Bank 0	Bank 1	Bank 2
8MB	(2) 1MBx32/36		
16MB	(2) 1MBx32/36	(2) 1MBx32/36	
16MB	(2) 2MBx32/36		
24MB	(2) 1MBx32/36	(2) 1MBx32/36	(2) 1MBx32/36
24MB	(2) 2MBx32/36	(2) 1MBx32/36	
32MB	(2) 2MBx32/36	(2) 1MBx32/36	(2) 1MBx32/36
32MB	(2) 4MBx32/36		
40MB	(2) 2MBx32/36	(2) 2MBx32/36	(2) 1MBx32/36
40MB	(2) 4MBx32/36	(2) 1MBx32/36	
48MB	(2) 2MBx32/36	(2) 2MBx32/36	(2) 2MBx32/36
48MB	(2) 4MBx32/36	(2) 1MBx32/36	(2) 1MBx32/36
48MB	(2) 4MBx32/36	(2) 2MBx32/36	
56MB	(2) 4MBx32/36	(2) 2MBx32/36	(2) 1MBx32/36
64MB	(2) 4MBx32/36	(2) 2MBx32/36	(2) 2MBx32/36
64MB	(2) 4MBx32/36	(2) 4MBx32/36	
64MB	(2) 8MBx32/36		
72MB	(2) 4MBx32/36	(2) 4MBx32/36	(2) 1MBx32/36
72MB	(2) 8MBx32/36	(2) 1MBx32/36	

Table 3-1: Memory Configurations

### Chapter 3: Installing the D6-IN

---

Memory	Bank 0	Bank 1	Bank 2
80MB	(2) 4MBx32/36	(2) 4MBx32/36	(2) 1MBx32/36
80MB	(2) 8MBx32/36	(2) 1MBx32/36	(2) 1MBx32/36
80MB	(2) 8MBx32/36	(2) 2MBx32/36	
96MB	(2) 8MBx32/36	(2) 2MBx32/36	(2) 2MBx32/36
96MB	(2) 4MBx32/36	(2) 4MBx32/36	(2) 4MBx32/36
96MB	(2) 8MBx32/36	(2) 4MBx32/36	
128MB	(2) 8MBx32/36	(2) 4MBx32/36	(2) 4MBx32/36
128MB	(2) 8MBx32/36	(2) 8MBx32/36	
128MB	(2) 16MBx32/36		
160MB	(2) 8MBx32/36	(2) 8MBx32/36	(2) 4MBx32/36
160MB	(2) 16MBx32/36	(2) 2MBx32/36	(2) 2MBx32/36
160MB	(2) 16MBx32/36	(2) 4MBx32/36	
192MB	(2) 8MBx32/36	(2) 8MBx32/36	(2) 8MBx32/36
192MB	(2) 16MBx32/36	(2) 4MBx32/36	(2) 4MBx32/36
192MB	(2) 16MBx32/36	(2) 8MBx32/36	
256MB	(2) 16MBx32/36	(2) 8MBx32/36	(2) 8MBx32/36
256MB	(2) 16MBx32/36	(2) 16MBx32/36	
384MB	(2) 16MBx32/36	(2) 16MBx32/36	(2) 16MBx32/36

Table 3-1: Memory Configurations

## Installing the SIMMs

To install the SIMMs, locate the memory banks on the system board and perform the following steps:

1. Hold the SIMM so that the notched edge is aligned with the notch on the SIMM socket (Figure 3-1).
2. Insert the SIMM at a 45 degree angle.
3. Gently push the SIMM into an upright position until it locks into place (past the release tabs).

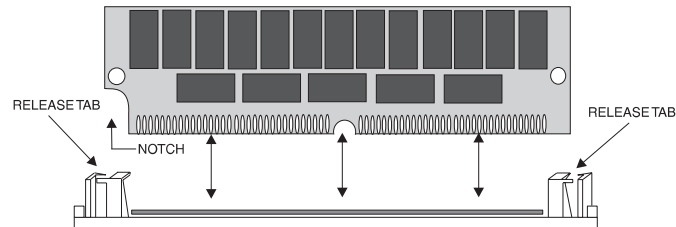

Figure 3-1: Installing a 72-Pin SIMM

## Removing SIMMs

To remove SIMMs, follow the steps below:

1. With both thumbs (or fingers), press the release tabs away from the socket.
2. With the SIMM free from the release tabs, lift the module up and place in an anti-static bag or package.

## **Installing a CPU**

The D6-IN is designed to support a variety of Pentium Pro processors. Follow the steps below to install a processor:

1. Turn off the computer and remove its cover.
2. Locate the ZIF socket illustrated in Figure 2-1.
3. Lift the lever of the socket.
4. Locate pin 1 on the processor and pin 1 on the socket (refer to Figure 2-1). Gently place the processor into the socket, making sure pin 1 on the processor and pin 1 on the socket are aligned.
5. Push the lever down until it locks into place.
6. Make sure the speed selection jumpers are set correctly (refer to Chapter 2 - Jumper Settings).

**WARNING:** *Pentium Pro processors require a heat-sink with a cooling fan. Failure to provide adequate cooling of the processor may seriously affect system performance or cause permanent damage to the processor.*

## Installing a PCI Peripheral Card

Micronics PCI slots accommodate all PCI peripherals that meet the PCI 2.1 specifications. Follow the steps below to install a PCI card:

1. Turn the computer system off and remove its cover.
2. Choose an unused PCI slot and remove the slot cover.
3. Insert the card with the bottom edge level to the slot.  
*Never insert the card at an angle.*
4. Carefully push the card straight down, making sure the card is fully inserted.
5. Replace the screw which holds the card into place.
6. Replace the computer cover.
7. Refer to the PCI card's documentation additional instructions regarding installation and software drivers.

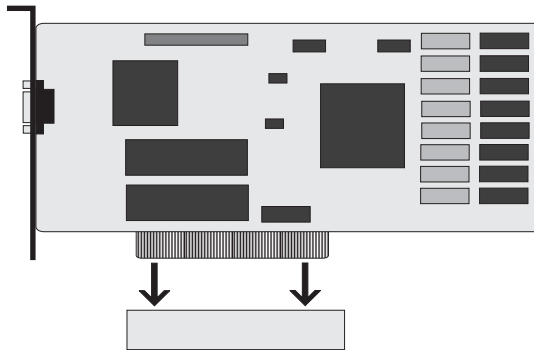

Figure 3-2: Installing a PCI Card

## Installing an ISA Peripheral Card

Micronics ISA slots accommodate all standard ISA peripherals. Follow the steps below to install a PCI card:

1. Turn the computer system off and remove its cover.
2. Choose an unused ISA slot and remove the slot cover.
3. Insert the card with the bottom edge level to the slot. *Never insert the card at an angle.*
4. Carefully push the card straight down, making sure the card is inserted fully.
5. Replace the screw that holds the card into place.
6. Replace the computer cover.
7. Refer to the ISA card's documentation for additional instructions regarding installation and software drivers.

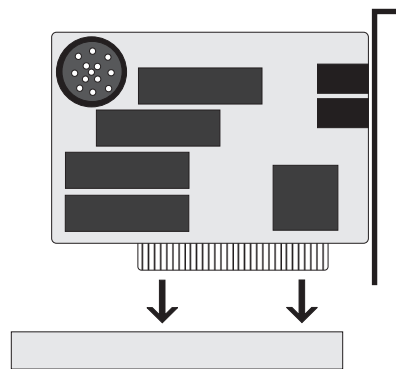

Figure 3-3: Installing an ISA Peripheral Card

## **Configuration**

After the D6-IN system board and all hardware is installed, the system is ready for configuration. Before turning on the computer, make sure all cables are correctly connected and all jumpers are correctly set.

It is recommended you keep the computer cover off the first time you boot the system. This will make it easier to correct any difficulties that might arise.

## **Initial Boot Up**

Power up the D6-IN. If the system does not properly boot, check all your cables and peripherals for bad connections. You may also get beep codes or error messages. If this occurs, consult Appendices B and/or C for a guide to possible solutions.

After the system properly boots, it is ready to be configured. The following information explains the proper procedures for BIOS configuration.

## **Setup**

The Setup program is used to configure the computer's BIOS (Basic Input/Output System). The computer's BIOS is responsible for configuring the system board and providing hardware information to the operating system. In order for the computer to run properly, run the Setup procedure after first installing the system board and whenever you make a hardware change to the system.

## Chapter 4: The BIOS Setup Utility

---

After the system is turned on and goes through a memory test, the Power-Up screen (Figure 4-1) will appear on your monitor:

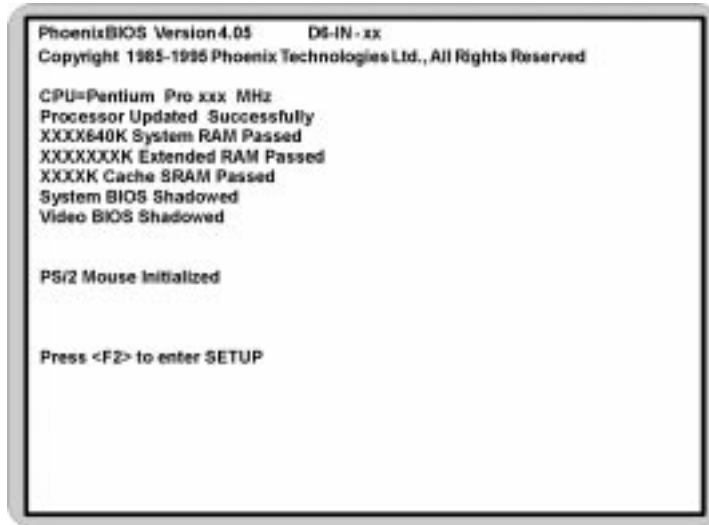

Figure 4-1: Power-Up Screen

When “Press <F2> to enter SETUP” appears at the bottom of the screen, press the <F2> key to begin the Setup procedure. The CMOS Main Screen (Figure 4-2) should appear and the prompt should be on the time line. The Setup procedure can only be activated during the boot sequence.

## Running the Setup Procedure

The D6-IN system board has six primary CMOS configuration screens: Main Screen, Advanced Screen, Security Screen, Power Screen, Boot Screen and Exit Screen. To toggle between the screens, press the right arrow <→> and the left arrow <←> keys.

## Setting the Main Screen

The CMOS Main screen (Figure 4-2) is used to set the time and date, to set the floppy drive types, to configure the hard disks and to configure the video. This section explains how to configure each of these categories. To move between the categories, use the up and down arrow <↑/↓> keys.

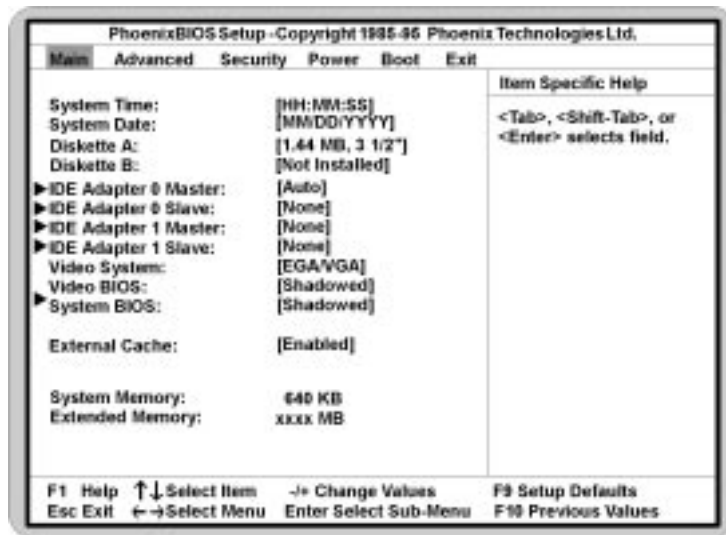

Figure 4-2: CMOS Main Screen

### **System Time and Date**

To set the time, use the <-> key to decrease the number and the <+> key to increase the number. To move the prompt forward, use the <Tab> key; to move the prompt backward, use the <Shift-Tab> key. To set the date, use the up and down arrows<↑/↓> to highlight the System Date and follow the same procedure used to set the time.

### **Diskette A or B**

To configure a floppy drive added to or removed from your computer, use the up and down arrow keys <↑/↓> to select the desired drive. Use the <+/-> keys to change the setting until it matches the floppy drive you installed. The BIOS supports 2.88MB, 1.44MB, 1.2MB, 720KB, and 360KB floppy drives.

### **IDE Adapters (Hard Disk Setup)**

If you are setting up a SCSI hard disk, select None in the IDE Device parameters (see your SCSI card manual for more details). To install an IDE device, select the device to configure and press ENTER. An IDE Device submenu will appear (see Figure 4-3).

### **Video System**

This sets the type of video board installed into the system. You may choose EGA/VGA (default), CGA 80x25 or MONO.

### **Video BIOS**

The Video BIOS category allows you to Shadow or Shadow & Cache the video BIOS. Choosing Shadowed (default) copies the video BIOS into RAM for faster

execution. Choosing Shadowed & Cached caches the shadowed video BIOS for even higher performance. To disable the Video BIOS category, select Disabled.

### **System BIOS**

This option allows you to shadow or shadow & cache the system BIOS.

### **External Cache**

This selection allows you to enable or disable the external memory cache. For optimal performance, select Enable (default).

### **System Memory**

The System Memory category identifies the size of the base memory. It cannot be changed.

### **Extended Memory**

The Extended Memory category automatically detects the amount of memory installed above the amount in the System Memory category. Because the BIOS automatically calculates the amount of memory installed in your system, you cannot change this category without adding or removing memory.

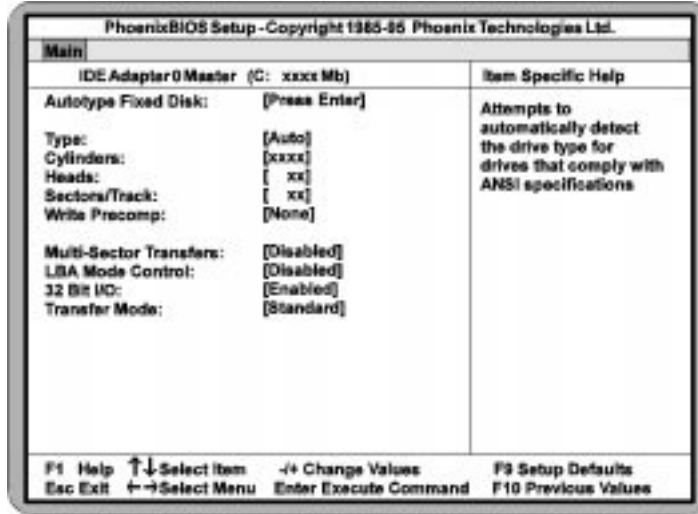

Figure 4-3: IDE Device Submenu

### Autotype Fixed Disk

The easiest way to set your IDE devices is to let the BIOS do it for you. When the IDE Device submenu first appears, the Autotype Fixed Disk selection is highlighted. Simply press ENTER and the remaining information is entered automatically.

Do not adjust the rest of the settings unless absolutely necessary. The BIOS automatically enters the optimal settings.

### Type

This category selects the drive type installed in the system. The options are None, 1-39, Auto (default) and User.

If Autotype Fixed Disk does not find your drive's parameters, fill this information in manually under the User category. This information may be in the manual that

came with your system. If not, contact your dealer or the hard drive manufacturer to fill in this category. If you are using a SCSI hard drive, select None and refer to the documentation which came with the SCSI adapter.

### **Multiple-Sector Transfers**

This category determines the number of sectors per block for multiple sector transfers. The options are Disabled (default), 2 Sectors, 4 Sectors, 8 Sectors and 16 Sectors.

### **LBA Mode Control**

Enable LBA (Logical Block Addressing) to support IDE drives larger than 528MB in size. The default setting is Disabled.

### **32-Bit I/O**

This category allows you to enable the 32-bit I/O function of the PCI IDE controller. Select Disabled if your drive will not run at this speed. The default setting is Enabled.

### **Transfer Mode**

This category provides the transfer modes for the PCI IDE controller. The options are Fast PIO 4, Fast PIO 3, Fast PIO 2, Fast PIO 1 and Standard (default).

Fast PIO 4 is equivalent to Mode 4 supporting a minimum cycle time of 120ns (16.6MB/sec.). Fast PIO 3 is equivalent to Mode 3 supporting a minimum cycle time of 180ns (11.1 MB/sec.). Fast PIO 2 supports a minimum cycle time of 240ns (8.33 MB/sec.). Fast PIO 1 supports a minimum cycle time of 383ns (5.22 MB/sec.). Standard supports a minimum cycle time of 600ns (3.3 MB/sec.).  
*NOTE:* See your drive specifications before setting this category.

## Setting the Advanced Screen

To move to the Advanced screen, use the left and right arrow keys <←/→> keys until you see the screen below.

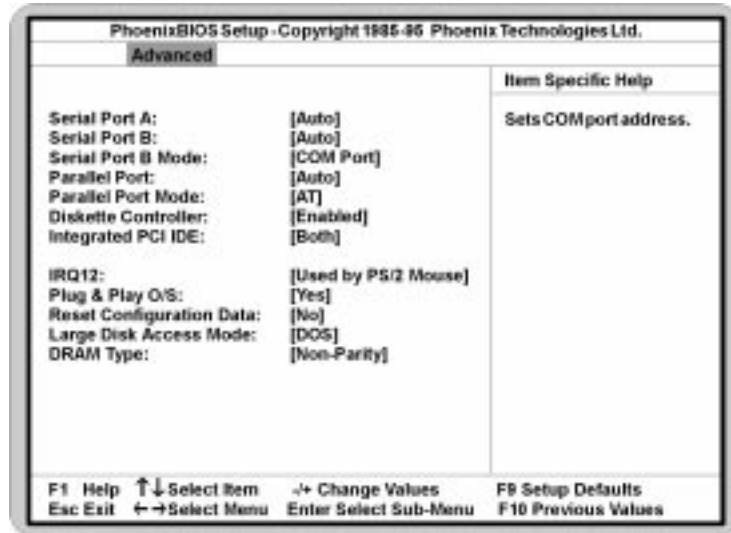

Figure 4-4: Advanced Screen

### Serial Port A

Serial Port A may be set for Auto (default), COM1, COM2, COM3, COM4 or Disabled.

### Serial Port B

Serial Port B may be set for Auto (default), COM1, COM2, COM3, COM4 or Disabled.

### Serial Port B Mode

Serial Port B Mode may be set for COM Port (default), IrDA or ASK-IR. This selection sets the interface to standard or infrared.

### **Parallel Port**

The parallel port may be set for Auto (default), LPT1, LPT2 or may be disabled.

### **Parallel Port Mode**

The parallel port may be set for output mode (AT) (default), bidirectional mode (PS/2) and Extended Capabilities Port (ECP).

### **Diskette Controller**

The floppy disk controller may be enabled or disabled.

### **Integrated PCI IDE**

Enables the integrated Local Bus IDE adapter. The PCI IDE controller may be set for Primary (up to two hard disks), Both (up to four hard disks) or it may be disabled. The default setting is Both.

### **IRQ12**

This selection routes IRQ12 to the PS/2 Mouse (default) or the ISA bus.

### **Plug & Play O/S**

This selection, when set to Yes (default), allows the system to work with a Plug and Play operating system such as Windows 95.

### **Reset Configuration Data**

Select Yes to clear the system configuration data. The default setting is No.

**Large Disk Access Mode**

If you are using a DOS operating system (MS-DOS, DR-DOS, or PC-DOS), set to DOS (default). If you are using anything else, set to OTHER.

**DRAM Type**

The DRAM type can be set for Non-Parity (default), Parity or ECC. Selecting ECC will detect the parity error and allow the system to correct the error.

## Security Screen

The Security screen (Figure 4-5) controls access to the computer. The security screen allows for settings of two passwords. The Supervisor Password allows access to the system and Setup. The User Password allows access to the system, but not to all Setup features.

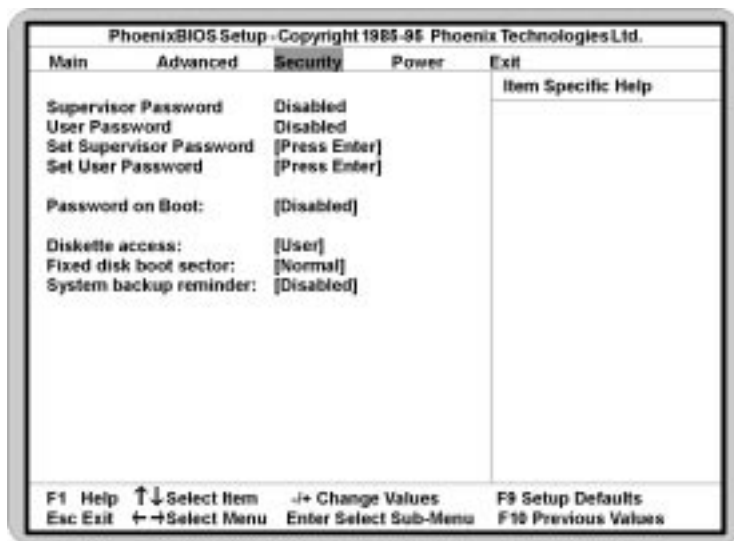

Figure 4-5: Security Setup Screen

### Supervisor Password

If a Supervisor Password is set up for the system, it reads Enabled. If the password is not set up, it reads Disabled (default).

### User Password

If a User Password is set up for the system, it reads Enabled. If the password is not set up, it reads Disabled (default).

### **Set Supervisor Password**

Press the ENTER key to enter the Supervisor Password submenu.

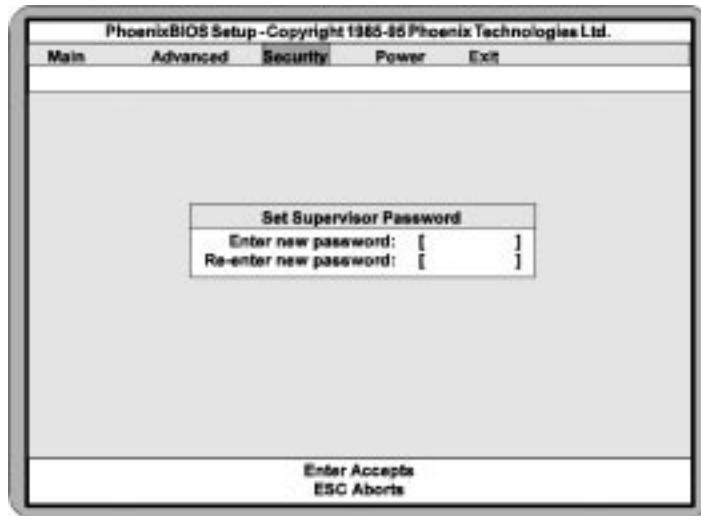

Figure 4-6: Supervisor Password Submenu

Type the password and press the ENTER key. Retype the password and press the ENTER key again. Write down the password somewhere safe so it will not be forgotten. The password may be disabled by setting the new password to nothing (pressing the ENTER key without first typing a password).

*WARNING: If you forget the Supervisor Password, it cannot be disabled without discharging the CMOS.*

### **Set User Password**

Follow the same procedure used to set the Supervisor Password.

*NOTE: After a password is entered, it is saved immediately. All other changes may still be discarded (see Exit Screen).*

### **Password on Boot**

When enabled, the system requires a password upon power-up. Either the Supervisor or User Password may be entered. The default setting is Disabled.

### **Diskette Access**

This selection allows floppy disk access with an option of the supervisor or user. Selecting Supervisor gives floppy disk access to the supervisor only. Selecting User (default) gives floppy disk access to both the user and the supervisor. If the passwords are enabled, this option may only be changed by the supervisor.

### **Fixed Disk Boot Sector**

This selection allows the boot sector of the fixed disk to be write protected. The default setting is Normal. When set for Write Protected, it serves as a form of virus protection. If the passwords are enabled, this option may only be changed by the supervisor.

### **System Backup Reminder**

When enabled, this selection displays a message during system bootup to remind you to backup your system. The options are Enabled or Disabled (default).

## Power Screen

The Power Screen controls the power management functions of the system. To move to the Power Screen, use the left and right arrow <←/→> keys until it appears (Figure 4-7). To move between the categories, use the up and down arrow keys <↑/↓>.

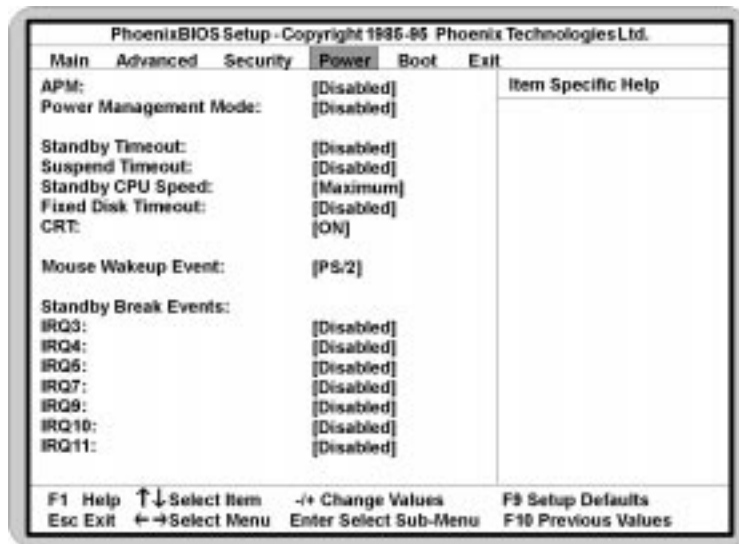

Figure 4-7: Power Screen

### APM

When enabled the power management features are active. The default setting is Disabled. If you enable this selection, you must also set the other power management options.

### Power Management Mode

This selection may be set for Maximum power savings, Medium power savings, Minimum power savings, Customized or Disabled (default). If you set this selection for

Maximum, Medium or Minimum power savings, you do not need to make any more adjustments. If you select Customized, you must set the following five categories.

### **Standby Timeout**

The Standby Timeout category sets the amount of time that elapses for the system to enter the power saving mode. The options are Disabled (default), 2 min., 15 min., 30 min., 60 min., 2 hr., 3 hr. or 4 hr. Before making changes, "Customized" must be selected in the Power Management Mode category.

### **Suspend Timeout**

The Suspend Timeout category sets the amount of time that elapses for the system to enter the Suspend Mode. The timer starts when the Standby Mode is activated. The options are Disabled (default), 2 min., 15 min., 30 min., 60 min., 2 hr., 3 hr., and 4 hr. Before making changes, "Customized" must be selected in the Power Management Mode category.

### **Standby CPU Speed**

This category sets the CPU speed during power saving mode. The options are Maximum (default), Medium, Minimum and Slowest. Before making changes, "Customized" must be selected in the Power Management Mode category.

### **Fixed Disk Timeout**

This category sets the amount of time that elapses before the IDE drive enters spin-down mode to conserve power. The options are Disabled (default), 1 min., 2 min., 5 min., 10 min., or 15 min. Before making changes, "Customized" must be selected in the Power Management Mode category.

## ***Chapter 4: The BIOS Setup Utility***

---

*NOTE: Do not enable this category unless your IDE drive supports spin-down mode.*

### **CRT**

Selecting ON (default) powers down the display while the system is in power saving mode. Before making changes, "Customized" must be selected in the Power Management Mode category.

### **Mouse Wakeup Event**

This selection causes the system to "wakeup" from a power savings mode if the mouse is moved or a button is pressed. The selections are PS/2 (IRQ12), COM1 (IRQ4), COM2 (IRQ3) or Disabled. The default setting is PS/2.

### **Standby Break Events**

Setting an IRQ category to Enabled causes the system to "wakeup" from a power savings mode if any activity occurs at that IRQ. For example, if you have a modem on IRQ3 and you set IRQ3 to enabled, the system automatically wakes up every time the modem gets a phone call. The default setting is Disabled.

## Boot Screen

The Boot screen allows you to configure the power-up system configuration settings.

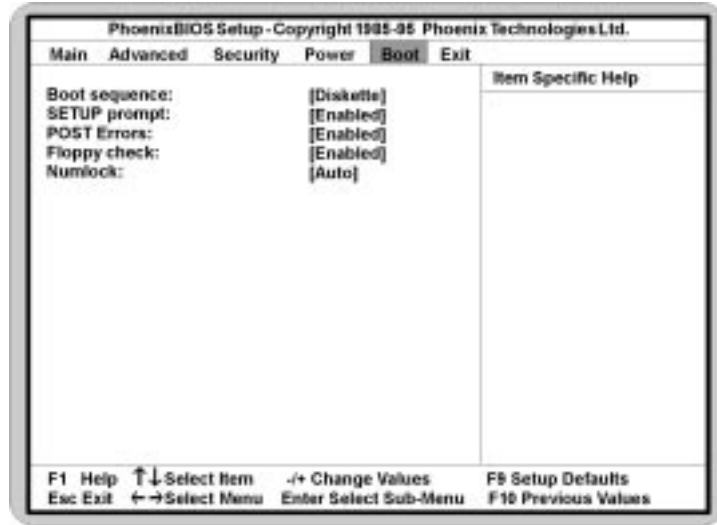

Figure 4-8: Boot Screen

### Boot Sequence

This selection will read the diskette drive (default) and the hard drive in sequence on boot.

### Setup Prompt

If this selection is enabled, the message "Press F2 to enter Setup" is displayed on boot. The default setting is Enabled.

### POST Errors

If this selection is enabled (default) and an error occurs on boot, the BIOS will display a SETUP entry or resume prompt. If this selection is disabled, the system will always attempt to boot.

### **Floppy Check**

This selection checks for the existence of a floppy drive. The default setting is Enabled.

### **Numlock**

This selection activates Numlock upon boot. Setting this to Auto (default) activates Numlock if the BIOS detects a numeric keyboard. It may also be turned ON or OFF.

### **Exit Screen**

After you complete configuring the BIOS, select the Exit screen.

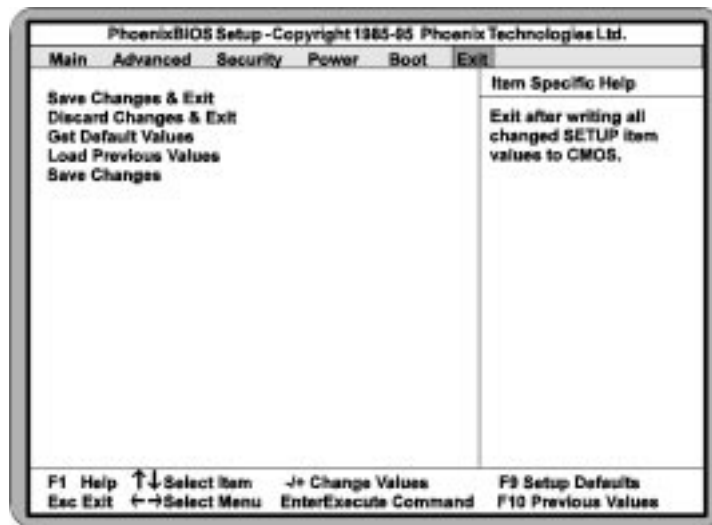

Figure 4-9: Exit Screen

Choose “Save Changes and Exit” and reboot the computer. Your computer is ready for use.

Appendix **Specifications**

**A**

Part Number:	09-00286-01
Processor:	Single ZIF socket 8 for Intel Pentium Pro 150, 166, 180 and 200MHz processors. Integrated Voltage Regulator Auto-detection of CPU voltage.
Chipset:	Intel 440FX PCI chipset. Intel PIIX 3. SMC FDC37C93X Ultra I/O chip.
CPU Clock Select:	Frequency synthesizer chip. Support for 60 and 66MHz CPU bus.
Form Factor:	Baby AT footprint.
Expansion:	Four 32-bit PCI slots. Three 16-bit ISA slots. One is a shared PCI/ISA slot.
BIOS:	Phoenix 4.0X Plug and Play BIOS on 1MB Flash. Auto-detection of memory size. Auto-detection of memory type. Auto-configuration of IDE hard disk types. APM 1.2
RAM Capacity:	Maximum memory 384MB. Supports EDO DRAM memory. ECC supported via chipset (36-bit SIMM).
Keyboard/Mouse:	Standard AT compatible (PS/2 style optional).

## ***Appendix A: Technical Information***

---

Internal Cache:	16K Level 1 Write Back on CPU chip 256K or 512K Level 2 cache in CPU
I/O Ports:	Two high speed serial ports (16550 compatible). Enhanced Parallel Port with ECP and EPP support. Infrared support for IrDA Two USB ports (optional)
Floppy Port:	Supports two floppy drives (2.88MB, 1.44MB, 1.2MB, 720K, 360K).
PCI IDE Ports:	Two 40-pin IDE connectors Mode 4 Enhanced IDE Bus Mastering controller. Multiple sector transfer support. Auto detection of add-in IDE board.

## **Environmental Specifications**

The environment in which the D6-IN is located is critical.  
Micronics recommends the following environmental specifications:

### **Temperature Range**

Operating: 50 to 104 degrees Fahrenheit (10 to 40 degrees Celsius).  
Non -Operating: 50 to 140 degrees Fahrenheit (10 to 60 degrees Celsius).  
Shipping: -22 to 140 degrees Fahrenheit (-30 to 60 degrees Celsius).

### **Relative Humidity**

Operating: 20% to 80%.  
Non-Operating: 5% to 90%.

## Battery Disposal

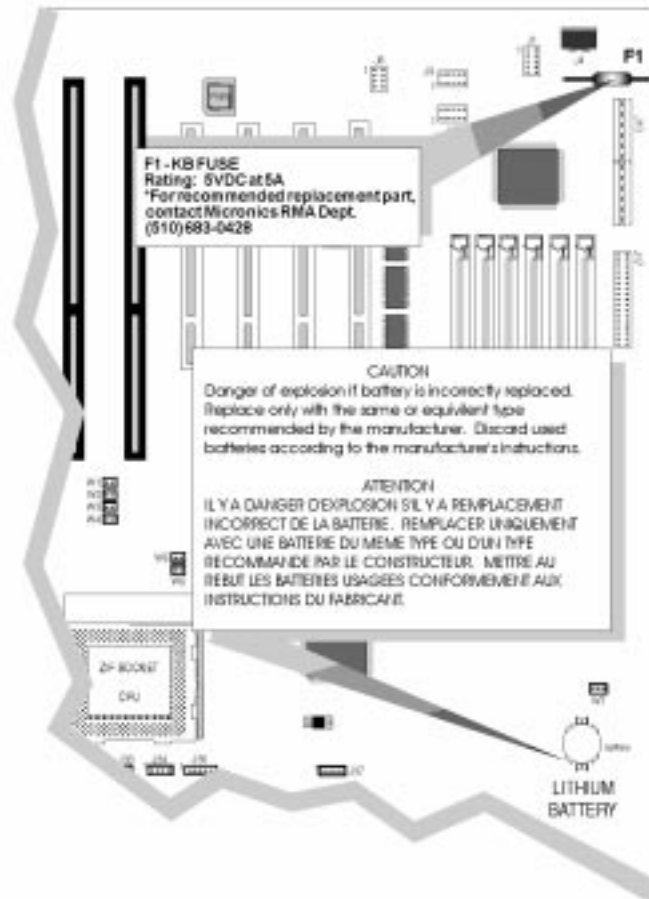

**WARNING:**

*Please do not open battery, dispose of in fire, recharge, put in backwards or mix with used or other battery types. The battery may explode or leak and cause personal injury.*

## Technical Support

If you need technical assistance, our Technical Support staff will be glad to assist you. You can contact us via telephone, fax or Bulletin Board System (BBS). Before calling please have the following information ready:

- The model name and 09 part number of your Micronics product.
- Your computer information such as CPU type, operating system, amount of installed memory and other peripherals installed in your computer.
- Try to call from the location of your computer.

**NOTE:** For Return Material Authorization (RMA) purposes, please keep a copy of your product receipt.

### In the United States:

Technical Support	(510) 661-3000
Technical Support Fax	(510) 651-6982
RMA Department	(510) 683-0428

### In Europe:

UK Technical Support	+ 44 (0) 1256 844899
UK Technical Support Fax	+ 44 (0) 1256 54476
Germany Technical Support	+ 49 (0) 89 68 81 646
Germany Technical Support Fax	+ 49 (0) 89 42 95 17
France Technical Support	+ 33 (1) 48 10 75 85
France Technical Support Fax	+ 33 (1) 48 10 75 55

## **Online Services**

### **Bulletin Board (BBS)**

In the United States:

Technical Support BBS (510) 651-6837  
14400 baud rate, Parity=N, Data Bits=8, Stop Bits=1,  
YMODEM and ZMODEM (recommended file transfer protocols)

In Europe:

UK Technical Support BBS +44 (0) 1256 63373  
Germany Technical Support BBS +49 (0) 89 68 81 686  
France Technical Support BBS +33 (1) 48 10 75 95

### **World Wide Web**

Micronics is on the Internet with a WWW (World Wide Web) site. Our Web site contains product support, press releases, contact information and other relevant material. Our address for Micronics Computers Inc. is:

<http://www.micronics.com>

***Appendix A: Technical Information***

---

**Appendix** ***POST Messages***

**B**

The following table lists the Power On Self Test (POST) messages, possible causes and solutions.

<b>Message</b>	<b>Possible Cause</b>	<b>Solution</b>
DISKETTE DRIVE A FAILURE	Drive A failed or is missing.	Check Setup and cable connections.
DISKETTE DRIVE B FAILURE	Drive B failed or is missing.	Check Setup and cable connections.
EXTENDED RAM FAILED AT OFFSET: nnnn	Extended memory not working or configured properly.	Replace defective memory.
FAILING BITS: nnnn	Memory failure in System, Extended, or Shadow memory.	Replace defective memory.
FIXED DISK X FAILURE (where X =0 or 1)	The hard disk is not configured or working properly.	Rerun SETUP and check connections, or replace hard disk.
FIXED DISK CONTROLLER FAILURE	The controller card has failed.	Check configuration and connections, or replace controller card.
INCORRECT DRIVE A TYPE	Floppy drive A: not set correctly in Setup.	Run Setup.
INCORRECT DRIVE B TYPE	Floppy drive A: not set correctly in Setup.	Run Setup.
INVALID NVRAM MEDIA TYPE	NVRAM chip is bad.	Requires repair of system board.
KEYBOARD ERROR, or KEYBOARD CONTROLLER ERROR	The keyboard or keyboard controller failed.	Check connections. You may have to replace the keyboard or controller.
KEYBOARD ERROR nn	A key is jammed or was held down during boot.	Make sure the keys are not jammed or dirty.
KEYBOARD LOCKED	Keyswitch on the front of the case is locked.	Unlock the keyswitch.

## Appendix B: POST Messages

---

Message	Possible Cause	Solution
MONITOR TYPE DOES NOT MATCH CMOS	Monitor type not correctly identified in Setup.	Run Setup and enter correct monitor type.
OPERATING SYSTEM NOT FOUND	Operating system cannot be located on Drive C: or Drive A:	Check Setup to see if Drive A: and C: are properly configured, or put a bootable disk in Drive A:
PARITY CHECK 1 nnnn	Parity error found in the system bus.	Check Setup. Board repair may be required.
PARITY CHECK 2 nnnn	Parity error found in the I/O bus.	Check Setup. Board repair may be required.
PREVIOUS BOOT INCOMPLETE - DEFAULT CONFIGURATION USED	Previous POST did not complete successfully.	Run Setup, load default BIOS settings, make any necessary adjustments, and save the changes
REAL TIME CLOCK ERROR	Real-time clock failed BIOS test.	May require battery replacement or board repair.
SHADOW RAM FAILED AT OFFSET	Shadow RAM failed.	May require repair of system board.
SYSTEM BATTERY IS DEAD	System battery died.	Replace the system battery and run Setup to reconfigure the system.
SYSTEM CACHE ERROR - CACHE DISABLED	External (L2) cache failed BIOS test.	System will still run, but slower. Replace cache at convenience.
SYSTEM CMOS CHECKSUM BAD - RUN SETUP	System CMOS has been corrupted or modified incorrectly.	Run Setup and reconfigure the system.
SYSTEM RAM FAILED AT OFFSET: nnnn	System RAM failed.	Replace defective RAM.
SYSTEM TIMER ERROR	Timer test failed.	Requires repair of system board.

Appendix

***Beep and POST Codes***

**C**

Beep codes are a series of beeps sent through the speaker which indicate a problem during the Power On Self Test (POST). If text appears on the video screen, the D6-IN has completed POST; any other tone from the speaker indicates something other than a POST error. These tones *are not* described in the tables on the following pages.

The beep error codes are a series of beeps. The duration of the beep tones are constant, but the length of the pauses between the beeps varies. For example: a 1-3-3 beep code will sound like one beep, a pause; three beeps consecutively, another pause and then three more beeps.

One beep code is often misunderstood. If a video card is not installed or is failing, the system board will generate a long-short-long-short beep code. This is often interpreted as a 1-2-1 beep code. But POST errors always vary in the length of the pause and not the duration of the beep tone.

Another way of identifying a POST error is to use a device called a POST card. This peripheral card is inserted into one of the ISA slots and has an LED (or LCD) read out showing the contents of port 80h.

The following tables list all beep codes and POST routines.

### Appendix C: Beep and POST Codes

---

Code	Beeps	POST Routine Description
02		Verify Real Mode.
04		Get CPU type.
06		Initialize system hardware.
08		Initialize chipset registers with initial POST values.
09		Get in POST Reg.
0A		Initialize CPU registers.
0C		Initialize cache initial POST values.
0E		Initialize I/O.
0F		Initialize the localbus IDE.
10		Initialize Power Management.
11		Load alternate registers with initial POST values.
12		Jump to UserPatch0.
14		Initialize keyboard controller.
16	2-2-3	BIOS ROM checksum.
18		8254 timer initialization.
1A		8237 DMA controller initialization.
1C		Reset Programmable Interrupt Controller.
20	3-1-1	Test DRAM refresh.
22	3-1-3	Test 8742 Keyboard Controller.
24		Set ES segment register to 4 GB.
28		Autosize DRAM.
2A		Clear 512K base RAM.
2C	3-4-1	Test 512K base address lines.
2E	3-4-3	Test 512K base memory.
32		Test CPU bus-clock frequency.
34		Test CMOS RAM.
35		Initialize alternate chipset registers.
37		Reinitialize the chipset (MB only).
38		Shadow system BIOS ROM.
39		Reinitialize the cache (MB only).
3A		Autosize cache.
3C		Configure advanced chipset registers.
3D		Load alternate registers with CMOS values.
40		Set initial CPU speed.
42		Initialize interrupt vectors.
44		Initialize BIOS interrupts.
46	2-1-2-3	Check ROM copyright notice.
47		Initialize manager for PCI Option ROMs.
48		Check video configuration against CMOS.
49		Initialize PCI bus and devices.

---

### ***Appendix C: Beep and POST Codes***

---

Code	Beeps	POST Routine Description
4A		Initialize all video adapters in system.
4C		Shadow video BIOS ROM.
4E		Display copyright notice.
50		Display CPU type and speed.
51		Initialize EISA board.
52		Test keyboard.
54		Set key click if enabled.
56		Enable keyboard.
58	2-2-3-1	Test for unexpected interrupts.
5A		Display prompt "Press F2 to enter SETUP".
5C		Test RAM between 512 and 640k.
60		Test extended memory.
62		Test extended memory address lines.
64		Jump to UserPatch1.
66		Configure advanced cache registers.
68		Enable external and CPU caches.
6A		Display external cache size.
6C		Display shadow message.
6E		Display non-disposable segments.
70		Display error messages.
72		Check for configuration errors.
74		Test real-time clock.
76		Check for keyboard errors.
7C		Set up hardware interrupt vectors.
7E		Test coprocessor if present.
80		Disable onboard I/O ports.
82		Detect and install external RS232 ports.
84		Detect and install external parallel ports.
86		Re-initialize on-board I/O ports.
88		Initialize BIOSData Area.
8A		Initialize Extended BIOS Data Area.
8C		Initialize floppy controller.
90		Initialize hard-disk controller.
91		Initialize localbus hard-disk controller.
92		Jump to UserPatch2.
93		Build MPTABLE for multi-processor boards.
94		Disable A20 address line.
96		Clear huge ES segment register.
98		Search for option ROMs.
9A		Shadow option ROMs.

### ***Appendix C: Beep and POST Codes***

---

Code	Beeps	POST Routine Description
9C		Set up Power Management.
9E		Enable hardware interrupts.
A0		Set time of day.
A2		Check key lock.
A4		Initialize typematic rate.
A8		Erase F2 prompt.
AA		Scan for F2 keystroke.
AC		Enter SETUP.
AE		Clear in-POST flag.
B0		Check for errors.
B2		POST done - prepare to boot operating system.
B4		One beep.
B6		Check password (optional).
B8		Clear global descriptor table.
BC		Clear parity checkers.
BE		Clear screen (optional).
BF		Check virus and backup reminders.
C0		Try to boot with INT 19.
D0		Interrupt handler error.
D2		Unknown interrupt error.
D4		Pending Interrupt.
D6		Initialize option ROM error.
D8		Shutdown error.
DA		Extended Block Move.
DC		Shutdown 10 error.
		The following are for boot block in Flash ROM:
E2		Initialize the chipset.
E3		Initialize refresh counter.
E4		Check for Forced Flash.
E5		Check HW status of ROM.
E6		BIOS ROM is OK.
E7		Do a complete RAM test.
E8		Do OEM initialization.
E9		Initialize interrupt controller.
EA		Read in the bootstrap code.
EB		Initialize all vectors.
EC		Boot the Flash program.
ED		Initialize the boot device.
EE		Boot code was read OK.

Appendix ***Hard Disk Drive Types***

**D**

The following table lists the hard disk types supported by the D6-IN.

Type	Cylinders	Heads	Write Precomp	Sectors	Size
1	306	4	128	17	10
2	615	4	300	17	21
3	615	6	300	17	32
4	940	8	512	17	65
5	940	6	512	17	99
6	615	4	none	17	21
7	462	8	256	17	32
8	733	5	none	17	31
9	900	15	none	17	117
10	820	3	none	17	21
11	855	5	none	17	37
12	855	7	none	17	52
13	306	8	128	17	21
14	733	7	none	17	44
15	N/A	N/A	N/A	N/A	N/A
16	612	4	0	17	21
17	977	5	300	17	42
18	977	7	none	17	59
19	1024	7	512	17	62
20	733	5	300	17	31
21	733	7	300	17	94
22	733	5	300	17	31
23	306	4	0	17	10
24	612	4	305	17	21
25	612	2	300	17	10
26	614	4	none	17	21
27	820	6	none	17	42
28	977	5	none	17	42
29	1218	15	none	36	336
30	1224	15	none	17	159

**Appendix D: Hard Disk Drive Types**

---

Type	Cylinders	Heads	Write Precomp	Sectors	Size
31	823	10	512	17	71
32	809	6	128	17	42
33	830	7	none	17	50
34	830	10	none	17	72
35	1024	5	none	17	44
36	1024	8	none	17	71
37	615	8	128	17	42
38	1024	8	none	26	109
39	925	9	none	17	72

Appendix ***Updating the System BIOS***

# E

The Micronics system boards are designed so that the BIOS can be reprogrammed using a BIOS file. You can easily FLASH a BIOS by following the steps below:

- 1) After downloading the appropriate BIOS file from our BBS or Website, extract it to a bootable MS-DOS 6.X diskette.
- 2) Reboot your system with the MS-DOS 6.X diskette in the A: drive. To make sure a clean DOS environment is loaded, press the F5 key while "Starting MS-DOS" is displayed. After the system has rebooted, the cursor will appear at the A:> prompt.
- 3) Now you can run the FLASH utility. The filename will be either "FSH" (or FSH20, FSH20G, etc.) or "PHLASH." Type this filename at the A:> prompt (but don't include its extension), followed by a space and the BIOS ROM image's filename. This file will be included in the download and has a file length of about 131K. For example, to update the D6-IN to BIOS version 01, you would type:

```
PHLASH D6-IN_01.ROM [ENTER]
```

- 4) Once the FLASH process has begun, select [Y]es, if prompted, to allow auto-sensing of the part (the FLASH chip itself).
- 5) After the update process has completed and the system reboots, verify that the new BIOS version appears on-screen. If you have problems during this process, or if you have questions about the procedure, please call Technical Support.

NOTE: If the BIOS is somehow erased or doesn't seem to accept the upgrade, you can have your original BIOS chip reprogrammed manually by Technical Support. There is a \$29.95 fee for this service, which includes shipping charges to send your FLASH EPROM chip



*If you encounter any problems during this process, or if you have questions about the procedure, please call Technical Support.*

## ***Appendix E: Updating the System BIOS***

---

back to you. Also, a preprogrammed FLASH EPROM chip can be purchased from Technical Support for \$50.00. Overnight shipping costs an additional \$10.00. (Price and availability subject to change.)

If you prefer to send your system board in for the upgrade, the RMA department offers this service free of charge if your system board is under warranty.

**Appendix Limited Warranty**

**F**

Except as described below, Micronics warrants the products to be free from defects in material and workmanship in normal use for a period of one (1) year from date of purchase. Should any product fail to perform according to this warranty at any time during the warranty period, except as provided below, Micronics or its authorized service centers will, at Micronics' option, repair or replace the product at no additional charge.

The warranty does not cover loss or damage which occurs in shipment or which is due to: (1) improper installation or maintenance, misuse, neglect or any cause other than ordinary commercial application, including without limitation, accidents or acts of God; (2) adjustment, repair, or modification by other than a Micronics authorized service center; (3) improper environment, excessive or inadequate heating or air conditioning, or electrical power failures, surges or other irregularities; (4) any statement about the product other than those set forth in this warranty; or (5) nonconformity to models or samples shown to the purchaser. Any models or samples were for the sole purpose of suggesting the character of the product and are not intended to form the basis of the bargain.

A receipt or copy of the invoice with the date of purchase from a Micronics reseller is required before any warranty service can be rendered. Service can be obtained by calling Micronics for a Return Merchandise Authorization (RMA) Number.

The RMA Number should be prominently displayed on the outside of the shipping carton of the returned product. Returned product should be shipped prepaid or hand carried to Micronics. The purchaser assumes risk of loss or damage in transit, and unless otherwise agreed to in writing by Micronics, will pay inbound shipping charges.

The exclusive remedy of the purchaser under this warranty above will be repair or replace at Micronics' option,

## ***Appendix F: Warranties and Notices***

---

but if for any reason that remedy should fail of its essential purpose, the exclusive remedy of the purchaser shall then be actual damages up to amounts paid for the defective product by the purchaser. This limited warranty shall be deemed to "fail of its essential purpose" if, after repeated efforts, Micronics is unable to make the product operate as warranted. Micronics' liability for damages to the purchaser for any cause whatsoever; regardless of the form of action and whether in contract or in tort, shall be limited to the purchase price in effect when the cause of action arose for the product that is the basis of the claim.

Micronics will not be liable for any lost profits or any indirect, special incidental or consequential damages in connection with the product, even if Micronics has been advised of the possibility of such damages.

Micronics makes no warranties or representations as to performance of products or as to service to distributor or to any person, except as set forth in Micronics' limited warranty accompanying delivery of product.

Micronics disclaims all other warranties whether oral, written, expressed, or implied, including without limitation, the warranties of design, merchantability, or fitness for a particular purpose, if applicable, or arising from a course of dealing, usage or trade practice.

### **Non-Warranty Service**

After the one year warranty service is no longer in effect, repair service is still available for Micronics products. For more information, contact Micronics' RMA department at (510) 683-0428. The RMA department is open between 8:30 A.M. and 5 P.M. Pacific Standard Time.

## **FCC Statement**

This equipment has been tested and found to comply within the limits for a Class B digital device, pursuant to Part 15 of the FCC Rules. These limits are designed to provide reasonable protection against harmful interference in a residential installation. This equipment generates, uses and can radiate radio frequency energy and, if not used in accordance with the instructions, may cause harmful interference to radio communications. Interference to radio or television reception can be determined by turning the equipment off and on. You are encouraged to try to correct the interference by one or more of the following measures:

- ④ Reorient the receiving antenna.
- ④ Increase the separation between the equipment and the receiver.
- ④ Connect the equipment into an outlet on a circuit different from that to which the receiver is connected.
- ④ Consult your dealer or an experienced radio/TV technician for help.

To meet FCC requirements, shielded cables are required.

*NOTE: Changes or modifications not expressly approved by Micronics could void your authority to operate the equipment.*

## **Declaration of Conformity**

Application of Council Directives 89/336/EEC. Standards to which the conformity is declared:

EN55022 EN50082-1

Manufacturer's Name: Micronics Computers, Inc.

Manufacturers Address: 221 Warren Avenue  
Fremont, California 94539 USA  
Telephone: (510) 651-2300  
Fax: (510) 651-9450

Type of Equipment: Pentium Pro 150/166/180/200MHz  
AT Form Factor Motherboard

Model Name: D6-IN

Tested by: Micronics Computers  
221 Warren Avenue  
Fremont, California 94539 USA  
Telephone: (510) 651-2300  
Fax: (510) 651-9450

Rockford Engineering Services, Inc.  
9959 Calaveras Road  
Sunol, CA. 94586-0543 USA  
Telephone: (510) 862-2944  
Fax: (510) 862-9013

Test Engineers John Y. Chan/Micronics (EN55022)  
Paramjeet Singh/RES (EN50082-1)

I, the undersigned, hereby declare that the specified equipment conforms to the directives and standards listed above.



Thomas Lui  
Compliance Engineering Manager  
September 10, 1996

## **Glossary**

**16550 UART** - A high speed chip for controlling serial ports. Although unnecessary for a mouse, it is required for modems that are 14,400 baud or faster.

**Asynchronous** - Operations that do not require the clocks of communicating devices to be coordinated. See Synchronous.

**Baby AT** - A standard system board size measuring approximately 13.25" x 8.5".

**Bidirectional Parallel Port** - A type of parallel port that can send and receive information.

**BIOS** - An Acronym for Basic Input/Output System. Configures the system board and provides hardware information to the operating system.

**Bit** - A contraction of Binary digit. The smallest unit of information in a binary number system. A bit represents a choice between either zero or one.

**Boot** - To start up the computer and load the operating system software. See cold boot and warm boot.

**Bus** - A group of electronic paths used to send data between parts of the system. On a system board, the bus connects the peripheral cards with the microprocessor via the expansion slots.

**Bus Mastering** - The ability of an peripheral card to control the bus without requiring intervention of the CPU.

**Byte** - A group of adjacent bits treated as a unit. Eight bits are typically considered one byte. Also called a character.

**Cache** - A process where information is copied from the slower memory (DRAM) to the faster memory (SRAM). Information that is likely to be read or edited is stored in the cache providing significant performance increases.

**Cache Hit** - The percentage of request for data from memory that can be served from the cache.

**Cache Miss** - A memory access which cannot be supplied from cache.

**Cold Boot** - Starting the computer by turning on the power or pressing the RESET button. A cold boot makes the processor execute all of the diagnostics. See boot and warm boot.

**CPU** - An acronym for Central Processing Unit. A CPU performs arithmetic calculations, makes logical decisions, and directs the operation of the computer in conjunction with the operating system.

**Disk Drive** - A hardware device which provides for the storage of data on diskettes or hard metal disks that have a magnetic coating. A disk drive

## ***Glossary***

---

functions by spinning at high speed while moving a device called the read/write head across the disk's surface in order to read or write data in magnetic code.

**DRAM** - An acronym for Dynamic Random Access Memory. A type of memory chip that only keeps its memory if supplied with regular clock pulses and a chance to regularly refresh its data. It is slower and more cost effective than SRAM. See SRAM.

**ECC** - An acronym for Error Checking and Correction. ECC enables parity checking and can detect and correct memory errors on the system board.

**ECP** - An acronym for Extended Capabilities Port. A standard set by Hewlett Packard and Microsoft Corporation to expand the capabilities of the parallel port.

**EDO Memory** - An acronym for Extended Data Out. A type of DRAM with built-in cache for enhanced performance.

**EISA** - An acronym for Extended Industry Standard Architecture. EISA is a bus design standard which is fully backward compatible with the ISA bus. Although it is a 32-bit bus, it only runs at 8MHz. See *PCI, VESA Local Bus and ISA*.

**EPP** - An acronym for Enhanced Parallel Port. A standard which increases the capabilities of the parallel port.

**EPROM** - Acronym for Erasable Programmable Read Only Memory. A type of ROM chip that can be programmed with relatively simple tools that will retain its data until erased. It can only be erased by exposing the circuitry in the chip to ultraviolet light. See also Flash ROM.

**Flash ROM** - A type of ROM chip that will retain its data until erased. It can be erased or reprogrammed by supplying it with +12V of voltage. See ROM and EPROM.

**Gigabyte** - A disk storage capacity measurement. Approximately one thousand megabytes or 1,073,741,824 bytes.

**IDE** - An acronym for Integrated Device Electronics. A standard for communicating between a hard drive and a computer.

**Internal Cache** - Cache which is built into the CPU. See Cache.

**ISA** - An acronym for Industry Standard Architecture. A well-established bus standard that originated with the IBM AT. See *PCI, VESA Local Bus and EISA*.

**Parallel** - A form of data transmission in which the data is sent one byte at a time over several wires that each carry one byte. In parallel transmission, all the bytes arrive simultaneously, as opposed to serial transmission in which bits arrive one by one.

**Parallel Port** - A connection for a printer or similar peripheral. Generally, parallel ports are output only. See Bidirectional Parallel Port and ECP.

**PCI** - An acronym for Peripheral Component Interconnect. A high performance 32-bit or 64-bit bus developed by Intel Corporation. PCI is designed to be independent of the hardware architecture to ensure compatibility with future computer systems. See *EISA, VESA Local Bus and ISA*.

**Pentium** - A high performance 64-bit CISC processor designed and manufactured by Intel Corporation.

**Plug and Play** - A standard developed to ensure easy installation of peripherals. Theoretically, a newly installed card will automatically configure itself and work properly without requiring jumper configuration or device drivers.

**POST** - An acronym for Power On Self Test. A diagnostic program that is run whenever the system is cold booted.

**RAM** - An acronym for Random Access Memory. A type of memory that is used as the "working memory" of a computer system. See DRAM and SRAM.

**ROM** - An acronym for Read Only Memory. A type of memory that retains its data without requiring power. Once written, it cannot be modified. See EPROM and Flash ROM.

**Serial** - A type of data transmission in which the data is sent one bit at a time over a single wire. See Parallel.

**Serial Port** - A communications port used to connect peripherals such as modems and mice.

**Setup** - A program that allows you to make changes to the system configuration.

**Shadow RAM** - A technique used to load a duplicate copy of BIOS from slower ROM into faster RAM. This enhances system performance because it provides higher access speed to the BIOS.

**SIMM** - An acronym for Standard Inline Memory Module. A small printed circuit board containing memory chips.

**SRAM** - An acronym for Static Random Access Memory. A type of memory that can retain data without requiring a regular clock signal. Although they are faster than DRAM, they hold less data and are more expensive.

**Synchronous** - Protocols that require the clocks of communicating machines or devices to be coordinated.

**Synchronous Cache** - A type of cache that uses a clock signal to latch the inputs and the data output. This structure spreads the cache access across two or three cycles while maintaining a bandwidth of one access per cycle. Improves performance by 5-10%.

## ***Glossary***

---

**Terabyte** - A measurement for very large storage capacity. One Terabyte is equivalent one-thousand gigabytes, one-million megabytes, or 1,099,511,627,766 bytes.

**VESA** - An acronym for Video Electronics and Standards Association.

**VESA Local Bus (VL-Bus)** - A high performance bus designed by VESA. A 32-bit version of the ISA bus which operates at the speed of the computer's CPU. See *PCI, EISA and ISA*.

**VGA** - An acronym for Video Graphics Array. A standard for monitor displays.

**VRM** - An acronym for Voltage Regulator Module. A power module that regulates voltage to the CPU.

**Warm Boot** - Restarting the system by simultaneously pressing the <Ctrl>, <Alt> and <Delete> keys.

**Write-Back Cache** - Upon a cache hit, the cache is updated and the main memory is not affected. Upon a cache miss, only the main memory is updated.

**Write-Through Cache** - Upon a cache hit, the cache and the main memory are updated. Upon a cache miss, only the main memory is updated.

## **Index**

---

---

### **B**

- Battery Disposal - 45
- Beep and POST Codes - 51
- BIOS
  - Configuration - 25
  - Setup - 25
- Bulletin Board System (BBS) - 47

---

---

### **C**

- Chassis - 16
- Configuring the D6-IN - 11

---

---

### **D**

- Diagram (D6-IN) - 12

---

---

### **E**

- Extended Data Out (EDO) Memory - 15, 17
- Environmental Specifications - 44
- Error Checking (ECC) - 15

---

---

### **F**

- Fast Page Mode (FPM) Memory - 15, 17

## ***Index***

---

---

---

### **H**

- Hard Disk Drive Types - 55
- Help
  - Bulletin Board System (BBS) - 47
  - Telephone Numbers - 46, 47
  - Troubleshooting - 49, 51

---

---

### **I**

- Installation
  - CPU - 22
  - Installing your D6-IN - 16
  - ISA Peripheral Card - 24
  - PCI Peripheral Card - 23
  - Quick Installation - 9

---

---

### **J**

- Jumper Settings - 13

---

---

### **M**

- D6-IN System Board Diagram - 12
- Memory
  - Configurations - 19
  - Installing - 21
  - Mixing - 18
  - Removing - 21
  - Supported - 17

---

---

### **O**

- Online Services - 47

---

---

**P**

- POST Messages - 49
- Power Supply - 16

---

---

**S**

- Specifications - 43
- System BIOS - 57

---

---

**T**

- Technical Specifications - 43
- Technical Support - 46
- Troubleshooting - 49, 51

---

---

**U**

- Updating the System BIOS - 57
- Utility Programs
  - Advanced Screen - 32
  - BIOS Setup - 25
  - Boot Screen - 41
  - Exit Screen - 42
  - IDE Device Submenu - 36
  - Main Screen - 27
  - Power Screen - 38
  - Security Screen - 35

---

---

**W**

- World Wide Web - 47