

MP-6VIP-C2

Motherboard

User's Manual

Product Name: MP-6VIP-C2
Manual Revision: English, 1.00
Release Date: June, 2000

Federal Communications Commission Statement

This device complies with FCC Rules Part 15. Operation is subject to the following two conditions:

- ♦ This device may not cause harmful interference
- ♦ This device must accept any interference received, including interference that may cause undesired operation.

This equipment has been tested and found to comply with the limits for a Class B digital device, pursuant to Part 15 of the FCC Rules. These limits are designed to provide reasonable protection against harmful interference in a residential installation. This equipment generates, uses and can radiate radio frequency energy. If this equipment is not installed and used in accordance with the manufacturer's instructions, it may cause harmful interference to radio communications. However, there is no guarantee that interference will not occur in a particular installation. If this equipment does cause harmful interference to radio or television reception, which can be determined by turning the equipment off and on, the user is encouraged to try to correct the interference by one or more of the following measures:

- ♦ Reorient or relocate the receiving antenna.
- ♦ Increase the separation between the equipment and receiver.
- ♦ Connect the equipment to an outlet on a circuit different from that to which the receiver is connected.
- ♦ Consult the dealer or an experienced radio/TV technician for help.

The use of shielded cables for connection of the monitor to the graphics card is required to assure compliance with FCC regulations. Changes or modifications to this unit not expressly approved by the party responsible for compliance could void the user's authority to operate this equipment.

Canadian Department of Communications Statement

This digital apparatus does not exceed the Class B limits for audio noise emissions from digital apparatuses set out in the Radio Interference Regulations of the Canadian Department of Communications.

Manufacturer's Disclaimer Statement

The information in this document is subject to change without notice and does not represent a commitment on the part of the vendor. No warranty or representation, either expressed or implied, is made with respect to the quality, accuracy or fitness for any particular purpose of this document. The manufacturer reserves the right to make changes to the content of this document and/or the products associated with it at any time without obligation to notify any person or organization of such changes. In no event will the manufacturer be liable for direct, indirect, special, incidental or consequential damages arising out of the use or inability to use this product or documentation, even if advised of the possibility of such damages. This document contains materials protected by copyright. All rights are reserved. No part of this manual may be reproduced or transmitted in any form, by any means or for any purpose without expressed written consent of its authors. Product names appearing in this document are mentioned for identification purposes only. All **trademarks**, product names or brand names appearing in this document are registered property of their respective owners.

Copyright © Magic-Pro Computer Co., LTD.

All rights reserved

Author : Raymond

Printed in Taiwan

June 2000

100% POST-CONSUMER
RECYCLED PAPER 

C O N T E N T

Chapter 1: Introduction	4
1-1 CPU	4
1-2 CHIPSET	4
1-3 L2 CACHE	4
1-4 MAIN MEMORY	4
1-5 BIOS	4
1-6 SUPER I/O FUNCTON	4
1-7 OTHER FEATURES	5
1-8.1 MOTHERBOARD LAYOUT --- MP-6VIP-C2	6
1-8.2 MOTHERBOARD LAYOUT --- MP-6VIP-C2X.....	7
Chapter 2: Hardware Setup	8
2-1 CPU INSTALLATION	8
2-2 CPU TYPE CONFIGURATION	10
2-3 SYSTEM MEMORY CONFIGURATION	12
2-4 JUMPER definitions	12
2-5 CONNECTORS	15
2-5.1 J1 SWITCH SIGNAL SUMMARY	16
2-5.2 J2 SWITCH SIGNAL SUMMARY	18
2-5.3 ATX POWER SUPPLY CONNECTOR	20
2-5.4 PS/2 MOUSE AND PS/2 KEYBOARD	20
2-5.5 IRQ DESCRIPTION	21
2-6 VOICE DIAGNOSTIC FUNCTION --- MP-6VIP-C2X.....	22
Chapter 3: BIOS Setup	23
3-1 STANDARD CMOS SETUP	24
3-2 BIOS FEATURES SETUP	26
3-3 CHIPSET FEATURES SETUP	30
3-4 POWER MANAGEMENT SETUP	33
3-5 PNP / PCI CONFIGURATION SETUP	37
3-6 LOAD SETUP DEFAULTS	39

3-7 CPU SPEED SETTING 40
3-8 INTEGRATED PERIPHERALS 42
3-9 SUPERVISOR / USER PASSWORD 46
3-10 HDD AUTO DETECTION 47
3-11 SAVE & EXIT SETUP 47
3-12 EXIT WITHOUT SAVING 47

Chapter 1: Introduction

1-1 CPU

- Supports Intel FC-PGA 370 Celeron / Pentium III (Coppermine) CPU at 300MHz up to 750MHz or higher.
- Supports VIA Cyrix III (Joshua) CPUs.
- Supports CPU voltage auto-detect circuit.
- Supports 66 / 75* / 83* / 100 / 103* / 112* / 124* / 133* / 140* / 150* MHz system bus speed.
- Clock multipliers up to 8x or higher.

1-2 CHIPSET

- VIA VT82C693A + VT82C596B chipset with 133MHz FSB.
- PCI Rev 2.1, 5V, 33MHz interface compliant.
- Supports 66 / 100 / 133MHz, 3.3V AGP (Accelerated Graphics Port) slot.

1-3 L2 CACHE

- Pentium II / Pentium III supports 512K write back cache with Pipelined Burst SRAMs.

1-4 MAIN MEMORY

- Memory range from 8MB up to 768MB (SDRAM) with DRAM Table Free configuration.
- Supports SDRAM with 12 / 10 / 8 / 6 ns speed.
- Supports 3pcs 168pin DIMM sockets. (3.3V Unbuffered and 4 clock type)
- DRAM supports ECC or Parity function.

1-5 BIOS

- Award Plug and Play BIOS.
- Supports ACPI and legacy APM.
- Flash Memory for easy upgrade.

1-6 SUPER I/O FUNCTION

- Integrated USB (Universal Serial Bus) controller with 2 USB ports.
- Supports 2 IDE channels with 4 IDE devices. (including ZIP / LS-120 devices)
- Provides PCI IDE Bus Master function and supports Ultra DMA33 / 66 function.

- Provides 1 floppy port.
- 2 high speed 16550A FIFO UART ports.
- 1 parallel port with EPP / ECP / SPP capabilities.
- PS/2 mouse connector and PS/2 keyboard connector.
- Built-In RTC, CMOS, keyboard controller on single I/O chip.
- Peripherals boot function. (with ATX power)

1-7 OTHER FEATURES

- ATX size 17.0cm x 30.5cm.
- 5x PCI Master slots, 1x ISA slot, 3x DIMM sockets, and 1x AGP slot.
- Provides DIP switch setting.
- Supports 66 / 100 / 133MHz Bus Clock.
- Supports WOL (Wake On LAN) function.
- Supports Keyboard Power On function.
- BIOS supports 103 / 112 / 133 / 150MHz Bus Clock.
- Provides Voice Diagnostic function for easy debug. (**MP-6VIP-C2X** only)

MAGIC-PRO MP-6VIP-C2

1-8.1 MOTHERBOARD LAYOUT --- MP-6VIP-C2

- DEFAULT SETTING: Celeron 300/66MHz, Pentium II / Pentium III! 450/100MHz.

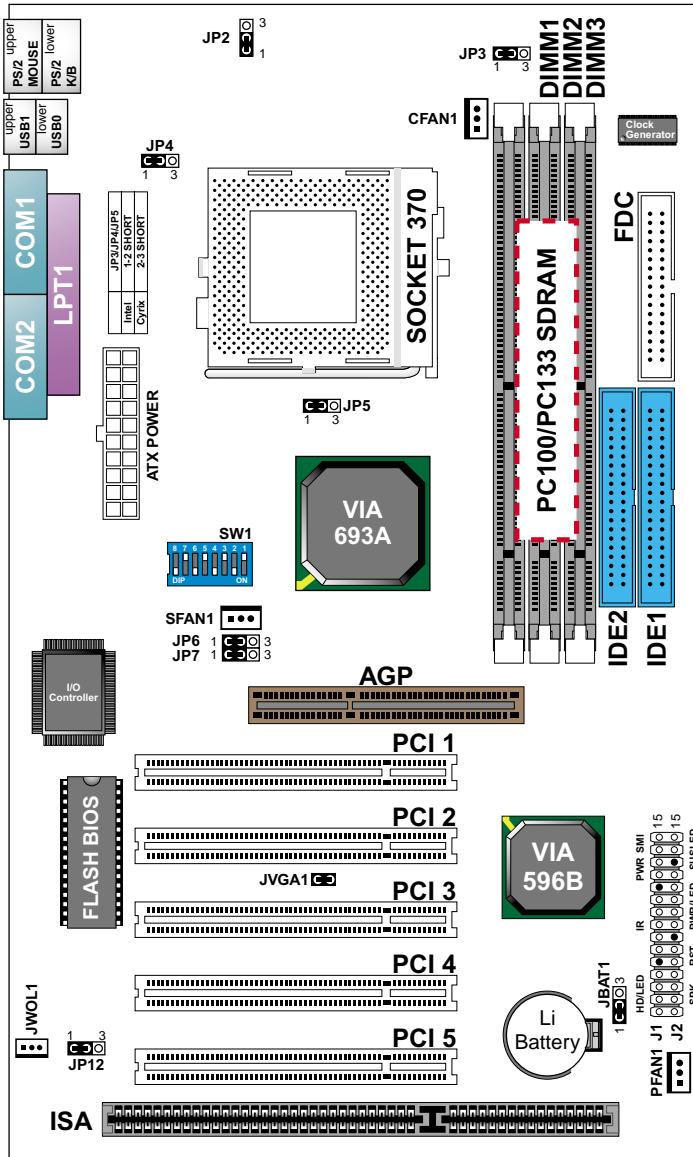

NOTE: FOR 100 / 133MHz CPU ENVIRONMENT, THE SDRAM MUST COMPLY WITH PC-100 / PC-133 SPEC.

1-8.2 MOTHERBOARD LAYOUT --- MP-6VIP-C2X

- DEFAULT SETTING: Celeron 300/66MHz, Pentium II / Pentium III! 450/100MHz.

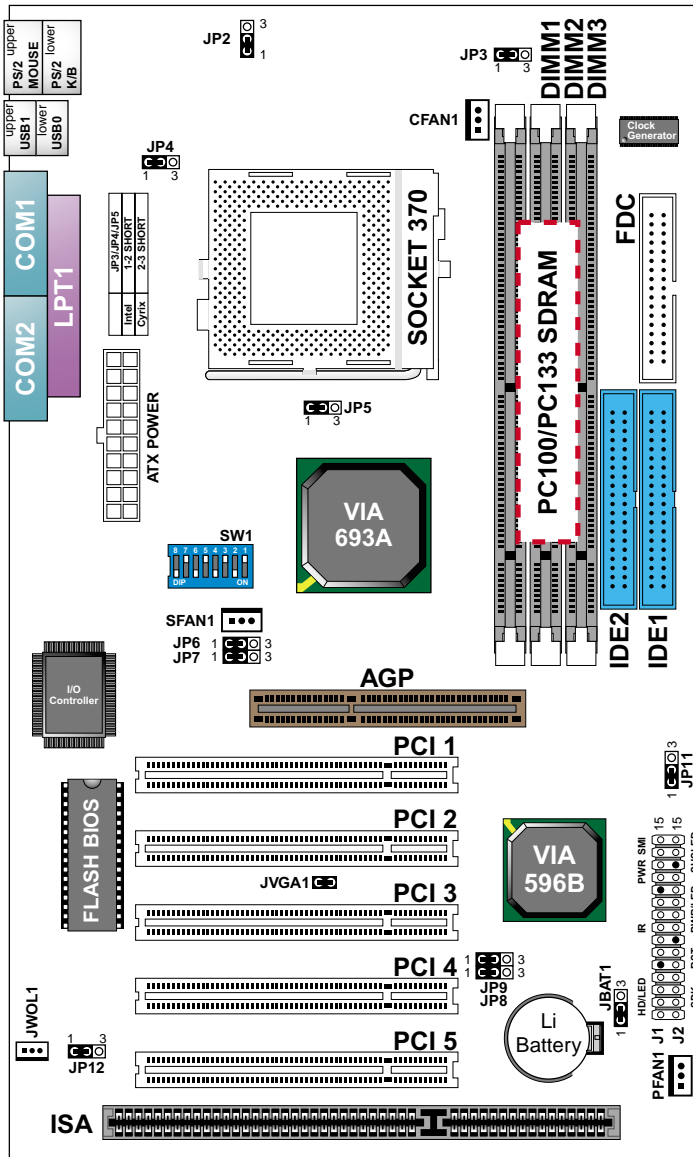

NOTE: FOR 100 / 133MHz CPU ENVIRONMENT, THE SDRAM MUST COMPLY WITH PC-100 / PC-133 SPEC.

Chapter 2: Hardware Setup

2-1 CPU INSTALLATION

1. Pull the lever sideways away from the socket, and then raise the lever up to a 90-degree angle.

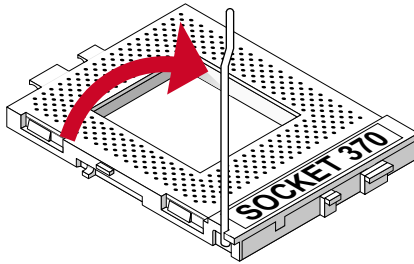

2. Take note of the red circle as below picture. When insert the CPU into socket, you can find out there is a definite pin orientation for CPU and socket.

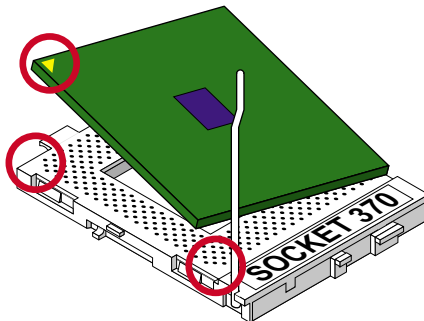

- 3. Make sure that the CPU positions in the socket tightly, and then put the lever down to complete the CPU installation.

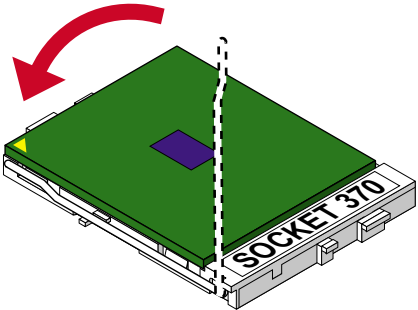





2-2 CPU TYPE CONFIGURATION

BUS RATIO SELECT

SW1 DIP1 ~ DIP4 SETTING	
<p>3.0x</p> <p>8 7 6 5 4 3 2 1</p>	<p>3.5x</p> <p>8 7 6 5 4 3 2 1</p>
<p>4.0x</p> <p>8 7 6 5 4 3 2 1</p>	<p>4.5x</p> <p>8 7 6 5 4 3 2 1</p>
<p>5.0x</p> <p>8 7 6 5 4 3 2 1</p>	<p>5.5x</p> <p>8 7 6 5 4 3 2 1</p>
<p>6.0x</p> <p>8 7 6 5 4 3 2 1</p>	<p>6.5x</p> <p>8 7 6 5 4 3 2 1</p>
<p>7.0x</p> <p>8 7 6 5 4 3 2 1</p>	<p>7.5x</p> <p>8 7 6 5 4 3 2 1</p>
<p>8.0x</p> <p>8 7 6 5 4 3 2 1</p>	

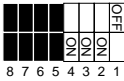
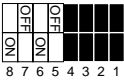
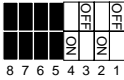
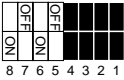
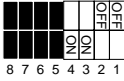
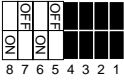
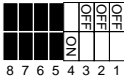
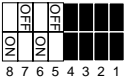
BUS CLOCK SELECT

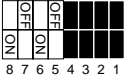
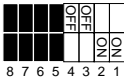
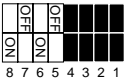
SW1 DIP5 ~ DIP8 SETTING	
<p>8 7 6 5 4 3 2 1</p>	<p>Auto Select 66/100/133 MHz (default)</p>
<p>8 7 6 5 4 3 2 1</p>	<p>66MHz</p>
<p>8 7 6 5 4 3 2 1</p>	<p>100MHz</p>
<p>8 7 6 5 4 3 2 1</p>	<p>133MHz</p>

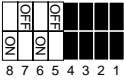
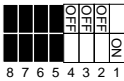
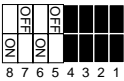
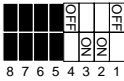
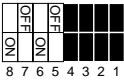
CPU MODEL	BUS RATIO	BUS CLOCK
Pentium III 533EB/133# (133MHz * 4.0x)	 ON	 ON
Celeron 300/66 (66MHz * 4.5x) Pentium III 600EB/133# (133MHz * 4.5x)	 ON	 ON
Celeron 333/66 (66MHz * 5.0x) Pentium III 500E/100# (100MHz * 5.0x) Pentium III 667B/133# (133MHz * 5.0x)	 ON	 ON
Celeron 366/66 (66MHz * 5.5x) Pentium III 550E/100# (100MHz * 5.5x) Pentium III 733B/133# (133MHz * 5.5x)	 ON	 ON
Celeron 400/66 (66MHz * 6.0x) Pentium III 600E/100# (100MHz * 6.0x)	 ON	 ON
Celeron 433/66 (66MHz * 6.5x) Pentium III 650/100# (100MHz * 6.5x)	 ON	 ON
Celeron 466/66 (66MHz * 7.0x) Pentium III 700/100# (100MHz * 7.0x)	 ON	 ON
Celeron 500/66 (66MHz * 7.5x) Pentium III 750/100# (100MHz * 7.5x)	 ON	 ON
Celeron 533/66 (66MHz * 8.0x)	 ON	 ON
Over 8.0x	Using these CPUs which bus ratio exceed 8.0x, user can not change all values from the DIP switch but detection by BIOS automatically.	

NOTE: (#) Pentium III Coppermin FC-PGA CPUs.

2-3 SYSTEM MEMORY CONFIGURATION



- This VIA 693 Apollo Pro Plus motherboard supports 168pin DIMM of 4MB, 8MB, 16MB, 32MB, 64MB, 128MB, and 256MB to form a memory size between 8MB up to 768MB (SDRAM). VIA 693 Apollo Pro Plus chipset provides “Table-Free” function. It means that users can install DRAM with any configuration and in any bank, and that is why the DRAM table is not needed but do remember that the DRAM must be 3.3V type. **For 100 / 133MHz CPU environment, the SDRAM specification must comply with PC-100 / PC-133 spec.**

2-4 JUMPER DEFINITIONS

- The figure below shows the location of the motherboard's jumper blocks.

CAUTION

- *Do not move the jumper with the power on. Always turn off the power and unplug the power cord from the computer before changing the jumper. Otherwise, the motherboard could be damaged.*

CFAN1/SFAN1/PFAN1: ONBOARD FAN (12V)	
CPU FAN	CFAN1 
SYSTEM FAN	SFAN1 
CHASSIS FAN	PFAN1 



Those connectors support processor/system/chassis cooling fan with +12V. Those support three pin head connector. When connecting the wire to FAN connectors, user should give attention that the red wire is the positive and should be connected to the +12V, the black wire is Ground and should be connected to GND. If your motherboard has Hardware Monitor chipset on-board, you must use a specially designed fan with speed sensor to take advantage of this function.

For fans with fan speed sensor, every rotation of the fan will send out 2 pulses. System Hardware Monitor will count and report the fan rotation speed.

















NOTE 1: Always consult vendor for proper CPU cooling fan.

NOTE 2: CPU FAN supports the FAN control. You can install PC Alert utility. This will automatically control the CPU FAN speed according to the actual CPU temperature.





JP2: KEYBOARD POWER ON	
Disabled (default)	JP2 
Enabled	JP2 



NOTE: When the keyboard power on function shows any compatible problem, choose Disabled and report to the keyboard vendor/manufacturer,

JP3/JP4/JP5: CPU SELECT			
Intel CPU (default)	JP3 	JP4 	JP5 
VIA Cyrix III (Joshua) CPU	JP3 	JP4 	JP5 



JP8/JP9: VOICE DIAGNOSTIC LANGUAGE SELECT	
Chinese Language	JP9  JP8 
English Language (default)	JP9  JP8 
Japanese Language	JP9  JP8 
Spanish Language	JP9  JP8 

NOTE: JP8, JP9 and JP11 are supported by **MP-6VIP-C2X** only.



JP6/JP7: USB PORT SELECT	
Redirect USB port to USB 1 connector (default)	JP6  JP7 
Redirect USB port to AGP	JP6  JP7 

JP11: VOICE CONTROLLER CHIP	
Enabled (default)	JP11 
Disabled	JP11 

MAGIC-PRO MP-6VIP-C2

JP12: POWER LOST RESUME	
Enabled	JP12 
Normal (default)	JP12 

NOTE: This jumper allows user to use the switch of ATX power supply to control ON/OFF switch directly instead of using the power switch on the motherboard.

JBAT1: CLEAR CMOS DATA	
Clear CMOS Data	JBAT1 
Retain Data (default)	JBAT1 

NOTE: We recommend user to unplug the power cord from ATX power supply to take precautions. Clear CMOS memory by shorting this jumper pin 2 & pin3 momentarily, and then remove the cap back to pin 1 & pin2 to retain original CMOS setting.

JWOL1 : WAKE ON LAN (WOL) FUNCTION	
Connect the Wake On LAN signal from LAN card to JWOL1	JWOL1 

NOTE: For support WOL function, the ATX power supply must provide at least 5V / 720mA standby current.

2-5 CONNECTORS

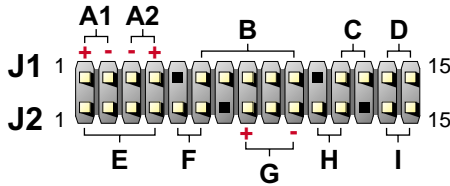

- A1 : 1st HDD LED
- A2 : 2nd HDD LED
- B : INFRARED (IR)
- C : POWER SWITCH
- D : SMI
- E : SPEAKER
- F : RESET SWITCH
- G : POWER LED
- H : KEYLOCK
- I : SUSPEND LED

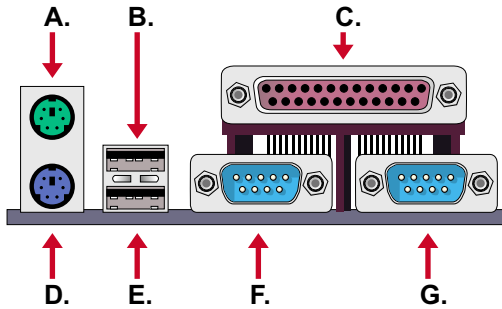

- A : PS/2 MOUSE
- B : USB O
- C : LPT 1
- D : PS/2 KEYBOARD
- E : USB 1
- F : COM 1
- G : COM 2

2-5.1 J1 SWITCH SIGNAL SUMMARY

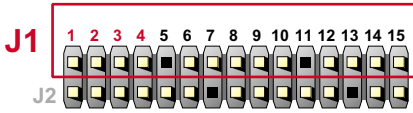

HDD LED CONNECTOR	
PIN 1	+5V
PIN 2	HDD LED SIGNAL
PIN 3	HDD LED SIGNAL
PIN 4	+5V
DESCRIPTION	This connector supplies power to the cabinet's IDE activity LED. Read and write activity by devices connected to the Primary or Secondary IDE connector will cause the LED to light up.



INFRARED CONNECTOR	
PIN 6	INFRARED TRANSMIT SIGNAL
PIN 7	GND
PIN 8	INFRARED RECEIVE SIGNAL
PIN 9	NONE
PIN 10	+5V
DESCRIPTION	This connector supports an optional wireless transmitting and receiving infrared module. This module mounts to a small opening on system cases that support this feature. User must also configure the setting through BIOS program "Peripheral Setup" to select whether UART2 is directed for use with COM2 or IrDA. Use the five pins and connect a ribbon cable from the module to the motherboard's IR connector according to the pin definitions.

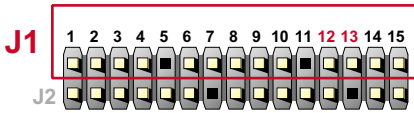

ATX POWER SWITCH	
PIN 12	ATX POWER SWITCH
PIN 13	GND
DESCRIPTION	<p>The system power is controlled by a momentary switch connected to this lead.</p> <p>Pressing the button once will switch the system between ON and SOFT OFF.</p> <p>Pushing the switch while in the ON mode for more 4 seconds will turn the system off.</p> <p>The system power LED shows the status of the system's power.</p>

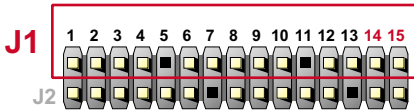

SMI CONNECTOR	
PIN 14	SMI(System Management Interrupt) SIGNAL
PIN 15	GND
DESCRIPTION	<p>This allows user to manually place the system into a suspend mode or "Green" mode, where system activity is decreased to save electricity and prolong the life of certain components when the system is not in use. This 2-pin connector connects to the case-mounted suspend switch. If you do not have a switch for the connector, you may use the "Turbo Switch".</p> <p>SMI is activated when it detects a short to open moment and therefore leaving it shorted will not cause any problems. This may require one or two presses depending on the position of the switch.</p> <p>Wake-Up can be controlled by settings in the BIOS but the keyboard will always allow wake-up(the SMI lead cannot wake up the system).</p>

2-5.2 J2 SWITCH SIGNAL SUMMARY



SPEAKER CONNECTOR	
PIN 1	SPEAKER SIGNAL
PIN 2	NONE
PIN 3	GND
PIN 4	+5V
DESCRIPTION	This SPEAKER connector connects to the case-mounted speaker. Two sources (LINE OUT and SPEAKER) allow you to hear system beeps and warnings. Only SPEAKER allows you to hear system beeps before the integrated audio has been properly initialized.



RESET SWITCH CONNECTOR	
PIN 5	RESET SIGNAL
PIN 6	GND
DESCRIPTION	RESET SWITCH connector connects to the case-mounted reset switch for rebooting your system without having to turn off your power switch. This is a preferred method of reboot to prolong the life of the system's power supply.



POWER LED CONNECTOR	
PIN 8	+5V
PIN 9	NONE
PIN 10	GND
DESCRIPTION	This Power LED connector connects the system power LED, which lights when the system is powered on and blinks when it is in sleep mode.



SUSPEND LED	
PIN 14	SUSPEND LED SIGNAL
PIN 15	GND
DESCRIPTION	Connect to Suspend indicator light.

2-5.3 ATX POWER SUPPLY CONNECTOR

- This connector connects to an ATX power supply. The plug from the power supply only inserts in an orientation because of the different hole sizes. Find the proper orientation and push down firmly making sure that all pins are aligned.
- Reminding that your power supply should support at least 10mA on the 5V standby voltage. It may cause a difficulty to power on the system if the power supply cant support the load.
- **For Wake On LAN function, the power supply should support at least 720mA current.**

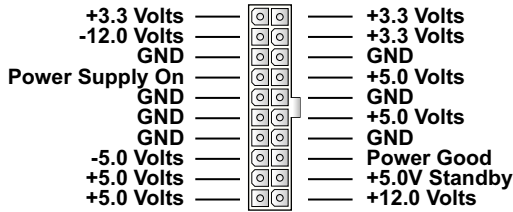

2-5.4 PS/2 MOUSE AND PS/2 KEYBOARD

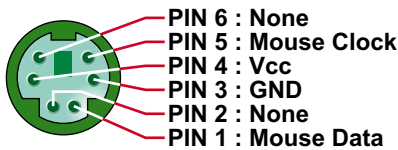

PS/2 MOUSE

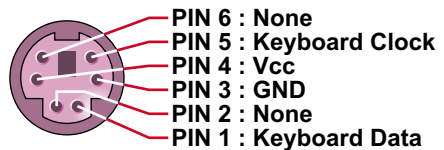

PS/2 KEYBOARD

2-5.5 IRQ DESCRIPTION

IRQ	Function Description	Priority
IRQ 0	System Timer	1
IRQ 1	Keyboard Controller	2
IRQ 2	Programmable Interrupt	N/A
IRQ 3	Serial Port (COM 2)	11
IRQ 4	Serial Port (COM 1)	12
IRQ 5		13
IRQ 6	Floppy Disk Controller	14
IRQ 7	Parallel Port (LPT1)	15
IRQ 8	Real Time Clock (RTC)	3
IRQ 9		4
IRQ 10		5
IRQ 11		6
IRQ 12	PS/2 Mouse Port	7
IRQ 13	Coprocessor	8
IRQ 14	Primary IDE Channel	9
IRQ 15	Secondary IDE Channel	10

- Both ISA and PCI expansion cards may require IRQs. System IRQs are available to cards installed in the ISA expansion bus first, then any remaining IRQs are available to PCI cards. Currently, there are two types of ISA cards.
- The original ISA expansion card design, now referred to as “Legacy” ISA card, requires that you configure the card’s jumpers manually and then install it in any available slot on the ISA bus. To see a map of your used and free IRQs in Windows 98, the *Control Panel* in *My Computer*, contains a *System* icon, which gives you a *Device Manager* tab. Double-Clicking on a specific hardware device gives you a *Resources* tab which shows the Interrupt number and address. Double-Clicking *Computers* to see all the interrupts and addresses for your system. Make sure that no two devices use the same IRQ or your computer will experience problems when those two devices are in use at the same time.

2-6 VOICE DIAGNOSTIC FUNCTION --- MP-6VIP-C2

- The Voice Diagnostic Function user with indispensable assist on troubleshooting while assembling your computer components. If there is any conflict or other potential problem triggers a boot-up failure, this voice controller chip will voice you realistically where the conflict/problem is, then user can remove the malfunction quickly.
- This function mainly provides 4 languages and their contents as following table:

English Voice Content
<ol style="list-style-type: none">1. No memory module2. Please check memory module3. Please clear CMOS setting4. Please check the Video adapter5. Please check hard disk cable or setting
國語語音內容
<ol style="list-style-type: none">1. 未安裝記憶體2. 請檢查記憶體3. 請清除 CMOS 設定4. 請檢查顯示卡5. 請檢查硬碟接線及設定
El Contenido Español de la Voz
<ol style="list-style-type: none">1. No hay modulo de memoria2. Por favor, chequea el modulo de memoria3. Por favor, borra CMOS setting4. Por favor, chequea la tarjeta de video5. Por favor, chequea el cable o la instalacion del disco duro
日本語音內容
<ol style="list-style-type: none">1. メモリーないじゃん (メモリーがありません)2. メモリーだめだめ (メモリーをチェックして下さい)3. CMOS だめっす? (CMOSの内容をクリアして下さい)4. VGA どう? (ビデオカードをチェックして下さい)5. ハードディスクつながってる? (HDDケーブル又は設定をチェックして下さい)

Chapter 3: BIOS Setup

- This 693 Apollo Pro Plus motherboard comes with the AWARD BIOS from AWARD Software Inc. Enter the Award BIOS program Main Menu by:

1. Turn on or reboot your system. After a series of diagnostic checks, the following message will appear:

PRESS TO ENTER SETUP

2. Press the key and the main program screen will appear as follows.

ROM PCI / ISA BIOS (2A6LGSNC)
CMOS SETUP UTILITY
AWARD SOFTWARE, INC.

STANDARD CMOS SETUP	CPU SPEED SETTING
BIOS FEATURES SETUP	INTEGRATED PERIPHERALS
CHIPSET FEATURES SETUP	SUPERVISOR PASSWORD
POWER MANAGEMENT SETUP	USER PASSWORD
PNP/PCI CONFIGURATION	IDE HDD AUTO DETECTION
LOAD SETUP DEFAULTS	SAVE & EXIT SETUP
	EXIT WITHOUT SAVING
Esc : Quit	↑ ↓ → ← : Select Item
F10 : Save & Exit Setup	(Shift) F2 : Change Color
Time, Date, Hard Disk Type...	

3. Using the arrows on your keyboard, select an option, and press <Enter>. Modify the system parameters to reflect the options installed in your system.
4. You may return to the Main Menu anytime by pressing <ESC>.
5. In the Main Menu, "SAVE AND EXIT SETUP" saves your changes and reboots the system, and "EXIT WITHOUT SAVING" ignores your changes and exits the program.

3-1 STANDARD CMOS SETUP

- Standard CMOS Setup allows you to record some basic system hardware configuration and set the system clock and error handling. You only need to modify the configuration values of this option when you change your system hardware configuration or the configuration stored in the CMOS memory gets lost or damaged.

Run the STANDARD CMOS SETUP as following:

1. Choose "STAND CMOS SETUP" from the Main Menu and a screen with a list of option will appear:

ROM PCI / ISA BIOS
STANDARD CMOS SETUP
AWARD SOFTWARE, INC.

Date (mm:dd:yy) : Tue, Oct 19 1999																	
Time (hh:mm:ss) : 15: 15: 20																	
HARD DISKS	TYPE	SIZE	CYLS	HEAD	PRECOMP	LANDZ	SECTOR MODE										
Primary Master	: Auto	0M	0	0	0	0	0 AUTO										
Primary Slave	: Auto	0M	0	0	0	0	0 AUTO										
Secondary Master	: Auto	0M	0	0	0	0	0 AUTO										
Secondary Slave	: Auto	0M	0	0	0	0	0 AUTO										
Drive A : 1.44, 3.5 in				<table border="1"> <tr> <td>Base Memory :</td> <td>640K</td> </tr> <tr> <td>Extended Memory :</td> <td>64512K</td> </tr> <tr> <td>Other Memory :</td> <td>384K</td> </tr> <tr> <td colspan="2"><hr/></td> </tr> <tr> <td>Total Memory :</td> <td>65536K</td> </tr> </table>				Base Memory :	640K	Extended Memory :	64512K	Other Memory :	384K	<hr/>		Total Memory :	65536K
Base Memory :	640K																
Extended Memory :	64512K																
Other Memory :	384K																
<hr/>																	
Total Memory :	65536K																
Drive B : None																	
Video : EGA / VGA																	
Halt On : All Errors																	
Esx : Quit		↑ ↓ → ← : Select Item		PU/PD/+/- : Modify													
F10 : Save & Exit Setup		(Shift) F2 : Change Color															

2. Use one of the arrow keys to move between options and modify the selected options by using PgUp / PgDn / + / - keys.

Date (mm:dd:yy) Set the current date and time.
Time (hh:mm:ss)

Primary / Secondary Master / Slave This field records the specifications for all non-SCSI hard disk drives installed in your system. Refer to the respective documentation on how to install the drives.

Drive A / Drive B Set this field to the type(s) of floppy disk drive(s) installed in your system. The choices are:
360KB, 5.25in.,
1.2MB, 5.25in.,
720KB, 3.5in.,
1.44MB, 3.5in., (default)
2.88MB, 3.5in.,
None.

Video Set this field to the type of video display card installed in the system. The choices are:
Monochrome,
Color 40x25,
VGA / EGA, (default)
Color 80x25.

Halt On Set this warning feature for the type of errors that will cause the system to halt. The choices are:
No Errors,
All, But Keyboard,
All, But Diskette,
All, But Disk / Key.

3. Press <ESC> to return to the Main Menu when you finish setting up all items.

3-2 BIOS FEATURES SETUP

- BIOS FEATURES SETUP allows you to improve your system performance or set up system features according to your preference.

Run the BIOS FEATURES SETUP as following:

1. Choose “BIOS FEATURES SETUP” from the Main Menu and a screen with a list of option will appear:

ROM PCI/ISA BIOS
BIOS FEATURES SETUP
AWARD SOFTWARE, INC.

Virus Warning	: Disabled	Video BIOS Shadow	: Enabled
CPU Internal Cache	: Enabled	C8000-CBFFF Shadow	: Disabled
External Cache	: Enabled	CC000-CFFFF Shadow	: Disabled
CPU L2 Cache ECC Checking	: Enabled	D0000-D3FFF Shadow	: Disabled
Quick Power On Self Test	: Enabled	D4000-D7FFF Shadow	: Disabled
BOot Sequence	: A, C, SCSI	D8000-DBFFF Shadow	: Disabled
Swap Floppy Drive	: Disabled	DC000-DFFFF Shadow	: Disabled
Boot Up Floppy Seek	: Disabled		
Boot Up NumLock Status	: On		
IDE HDD Block Mode	: Enabled		
Gate A20 Option	: Fast		
Memory Parity / ECC Check	: Disabled		
Typematic Rate Setting	: Disabled		
Typematic Rate (Chars / Sec)	: 6		
Typematic Delay (Msec)	: 250		
Security Option	: Setup	Esc : Quit	↑ ↓ → ← : Select Item
PCI / VGA Palette Snoop	: Disabled	F1 : Help	PU/PD/+/- : Modify
OS Select for DRAMs > 64MB	: Non-OS/2	F5 : Old Value	(Shift) F2 : Color
Report No FDD For WIN95	: No	F7 : Load Setup Defaults	

2. Use one of the arrow keys to move between options and modify the selected options by using PgUp / PgDn / + / - keys. An explanation of the <F> keys follows:

<F1>: “Help” gives options available for each item.

<Shift> + <F2>: Change color.

<F5>: Get the previous values. These values are the values with which the user started in the current session.

<F6>: Load all options with the BIOS default values.

<F7>: Load all options with the Setup default values.

- Virus Warning** Enabled: Activates automatically when the system boots up causing a warning message to appear if there is anything attempting to access the boot sector or hard disk partition table.
- Disabled: No warning message will appear when there is something attempting to access the boot sector or hard disk partition table.

NOTE: *Many diagnostic (or boot manager) programs which attempt to access the boot sector table can cause the above warning message. If you will be running such a program, we recommend that you disable the virus protection first.*

- CPU Internal Cache** Choose Enabled (default) or Disabled. This option allows you to enable or disable the CPU's internal cache.
- External Cache** Choose Enabled (default) or Disabled. This option allows you to enable or disable the external cache.
- Quick Power On Self Test** Choose Enabled (default) or Disabled. This option allows you to speed up the Power-On Self-Test routine.
- Boot Sequence** Default is "A, C, SCSI". This option determines which drive to boot at first for an operating system.
- Swap Floppy Drive** Choose Enabled or Disabled (default). This option swaps floppy drive assignments when it is enabled.
- Boot Up Floppy Seek** Enabled (default): During POST, BIOS checks the track number of the floppy disk drive to see whether it is 40 or 80 tracks.
- Disabled: During POST, BIOS will not check the track number of the floppy disk drive.
- Boot Up NumLock Status** Choose ON (default) or OFF. This option lets user activates the NumLock function at boot-up.

MAGIC-PRO MP-6VIP-C2

IDE HDD Block Mode Choose Enabled (default) or Disabled. If your hard disk size is larger than 540MB, then choose Enabled. If you are using the IDE HDD AUTO DETECTION option, the BIOS will choose this option automatically.

NOTE: *Some older model HDDs do not provide this feature.*

Gate A20 Option Choose Normal or Fast (default). This option allows the RAM to access the memory above 1MB by using the fast gate A20 line.

**Memory Parity /
ECC Check** Choose Enabled or Disabled.

Typematic Rate Setting Choose Enabled or Disabled (default). Enable this option to adjust the keystroke repeat rate.

**Typematic Rate (Chars
/ Sec)** Range between 6 (default) and 30 characters per second. This option controls the speed of repeating keystrokes.

**Typematic Delay
(Msec)** Choose 250 (default), 500, 750 and 1000. This option sets the time interval for displaying the first and the second characters.

Security Option Choose System or Setup (default). This option prevents unauthorized system boot-up or use of BIOS setup.

**PCI / VGA Palette
Snoop** Choose Enabled or Disabled (default). It determines whether or not the MPEG ISA cards can work with PCI / VGA.

**OS Select For DRAM >
64MB** Non-OS/2 (default): For Non-OS/2 system.
OS: For OS/2 operating system.

Report No FDD For Yes : BIOS reports "NO FDD" to Win95.
WIN95 No (default): BIOS will not report "NO FDD" to Win95.

Video BIOS Shadow Enabled copies Video BIOS to shadow RAM for improving performance.
The choice: Enabled (default), Disabled.

C8000-CBFFF to These options are used to shadow other expansion
DC000-DFFFF Shadow card ROMs.

3. Press <ESC> to return to the Main Menu when you finish setting up all items.

3-3 CHIPSET FEATURES SETUP

- CHIPSET FEATURES SETUP allows you to change the values of chipset registers. These registers control the system options.

Run the CHIPSET FEATURES SETUP as following:

1. Choose “CHIPSET FEATURES SETUP” from the Main Menu and a screen with a list of option will appear:

ROM PCI/ISA BIOS
CHIPSET FEATURES SETUP
AWARD SOFTWARE, INC.

Bank 0/1 DRAM Timing : SDRAM 10ns Bank 2/3 DRAM Timing : SDRAM 10ns Bank 4/5 DRAM Timing : SDRAM 10ns SDRAM Cycle Length : 3 DRAM Clock : Host CLK Memory Hole : Disabled Read Around Write : Enabled Concurrent PCI/Host : Disabled System BIOS Cacheable : Disabled Video RAM Cacheable : Disabled AGP Aperture Size : 64M AGP-2X Mode : Disabled OnChip USB : Enabled USB Keyboard Support : Disabled	Esc : Quit ↑ ↓ → ← : Select Item F1 : Help PU/PD/+/- : Modify F5 : Old Value (Shift) F2 : Color F7 : Load Setup Defaults
---	--

2. Use one of the arrow keys to move between options and modify the selected options by using PgUp / PgDn / + / - keys. An explanation of the <F> keys follows:

<F1>: “Help” gives options available for each item.

<Shift> + <F2>: Change color.

<F5>: Get the previous values. These values are the values with which the user started in the current session.

<F6>: Load all options with the BIOS default values.

<F7>: Load all options with the Setup default values.

- Bank 0/1 2/3 4/5 DRAM Timing** This item allows you to select the value in this field, depending on whether the board has paged DRAMs or EDO (Extended Data Output) DRAMs.
The choice: EDO 50ns,
EDO 60ns,
Slow,
Medium,
Fast,
Turbo.
- SDRAM Cycle Length Time** You can select CAS latency time in HCLKs of 2/2 or 3/3. The system board designer should have set the values in this field, depending on the DRAM installed. Do not change the values in this field unless you change specifications of the installed DRAM or the installed CPU.
- Read Around Write** DRAM optimization feature: If a memory read is addressed to a location whose latest write is being held in a buffer before being written to memory, the read is satisfied through the buffer contents, and the read is not sent to the DRAM.
The choice: Enabled, Disabled.
- Concurrent PCI / HOST** When disabled, CPU bus will be occupied during the entire PCI operation period.
The choice: Enabled, Disabled.
- System BIOS Cacheable** Choose Enabled or Disabled (default). When enabled, the access to the system BIOS ROM addressed at F0000H - FFFFFH is cached.
- Video RAM Cacheable** Choose Enabled or Disabled (default). When enabled, the access to the VGA RAM addressed is cached.
- AGP Aperture Size (MB)** Choose 4, 8, 16, 32, 64 (default), 128 or 256 MB. Memory mapped and graphics data structures can reside in a Graphics Aperture. This area is like a linear buffer. BIOS will automatically report the starting address of this buffer to the O.S.

MAGIC-PRO MP-6VIP-C2

AGP-2X Mode This item allows you to enable / disable the AGP-2X (Clock 133MHz) mode.

OnChip USB This should be enabled if our system has a USB installed on the system board and you wish to use it. Even when so wquipped, if you add a higher performance controller, you will need to disable this feature. The choice: Enabled, Disabled.

USB Keyboard Support Enabled: Enable function when the USB keyboard is being used.
Disabled (default): When the AT keyboard is being used, choose disabled.

3. Press <ESC> to return to the Main Menu when you finish setting up all items.

3-4 POWER MANAGEMENT SETUP

- POWER MANAGEMENT SETUP allows you to set the system's power saving functions.

Run the POWER MANAGEMENT SETUP as following:

1. Choose "POWER MANAGEMENT SETUP" from the Main Menu and a screen with a list of option will appear:

ROM PCI/ISA BIOS
POWER MANAGEMENT SETUP
AWARD SOFTWARE, INC.

ACPI function	: Disabled	Primary INTR	: ON
Power Management	: User Define	IRQ3 (COM 2)	: Primary
PM Control by APM	: Yes	IRQ4 (COM 1)	: Primary
Video Off After	: Suspend	IRQ5 (LPT 2)	: Primary
Video Off Method	: V/H SYNC+Blank	IRQ6 (Floppy Disk)	: Primary
MODEM Use IRQ	: 3	IRQ7 (LTP 1)	: Primary
Soft-Off by PWRBTN	: Instant-Off	IRQ8 (RTC Alarm)	: Disabled
HDD Power Down	: Disabled	IRQ9 (IRQ2 Redir)	: Secondary
Doze Mode	: Disabled	IRQ10 (Reserved)	: Secondary
Suspend Mode	: Disabled	IRQ11 (Reserved)	: Secondary
** PM Events **		IRQ12 (PS/2 Mouse)	: Primary
VGA	: OFF	IRQ13 (Coprprocessor)	: Primary
LPT & COM	: LPT/COM	IRQ14 (Hard Disk)	: Primary
HDD & FDD	: ON	IRQ15 (Reserved)	: Disabled
DMA/Master	: OFF		
Modem Ring Resume	: Disabled	Esc : Quit	↑ ↓ → ← : Select Item
RTC Alarm Resume	: Enabled	F1 : Help	PU/PD/+/- : Modify
Date (of Month)	: 0	F5 : Old Value	(Shift) F2 : Color
Timer (hh:mm:ss)	: 0: 0: 0	F7 : Load Setup Defaults	

2. Use one of the arrow keys to move between options and modify the selected options by using PgUp / PgDn / + / - keys. An explanation of the <F> keys follows:

<F1>: "Help" gives oions available for each item.

<Shift> + <F2>: Change color.

<F5>: Get the previous values. These values are the values with which the user started in the current session.

<F6>: Load all options with the BIOS default values.

<F7>: Load all options with the Setup default values.

MAGIC-PRO MP-6VIP-C2

ACPI Function Enabled: Turn on ACPI function.
Disabled (default): Turn off ACPI function.

Power Management Choose Max. Saving, User Define (default), Disabled or Min. Saving.

PM Control by APM When enabled, an Advanced Power Management device will be activated to enhance the Max. Power Saving mode and stop the CPU internal clock, If Advanced Power Management (APM) is installed on your system, selecting Yes gives better power savings. If the Max. Saving is not enabled, this will be present to No.

Video Off Method This determines the manner in which the monitor is blanked.

V/H SYNC + Blank	This selection will cause the system to turn off the vertical and horizontal synchronization ports and write blanks to the video buffer.
Blank Screen	This option only writes blanks to the video buffer.
DPMS	Select this option if your monitor supports the Display Power Management Signaling (DPMS) standard of the Video Electronics Standards to select video power management values.

Video Off After Choose NA, Suspend, Standby (default), or Doze.

MODEM Use IRQ This determines the IRQ in which the MODEM can use.
The choice: 3, 4, 5, 7, 9, 10, 11, NA.

Soft-Off by PWR-BTTN Instant-Off (default): Turn off the system poer at once after pushing the power button.
Delay 4 Sec: Turn off the system power 4 seconds after pushing the power button. (to meet PC97/98 spec)

Doze Mode This mode sets the CPU speed down to 33MHz.

Standby Mode / Suspend Mode These two options allow you to choose the mode for the different timers. The Standby Mode turns off the VGA monitor, and the Suspend Mode turns off the CPU and saves the energy of the system.

HDD Power Down Time is adjustable from 1 to 15 minutes. When the set time has elapsed, the BIOS sends a command to the HDD to power down, which turns off the motor.

Modem Ring Resume An input signal on the serial Ring Indicator (RI) Line (in other words, an incoming call on the modem) Awakens the system from a soft off state.

RTC Alarm Resume When Enabled, you can set the data and time at the which the RTC (Real Time Clock) alarm awakens the system from suspend mode.
The choice: Disabled (default), Enabled.

Date (of Month) Set a certain date when RTC Alarm Resume option is Enabled to awaken the system. This option is concurrent with Resume Time option.

Time (hh:mm:ss) Set a certain time when RTC Alarm Resume option is Enabled to awaken the system. This option is concurrent with Date option.

Primary INTR When set to On, any event occurring at will awaken a system which has been powered down.
On (default): The system can not enter the power saving mode when I/O ports or IRQ# is activated.
Off: The system can enter the power saving mode when I/O ports or IRQ# is activated.

MAGIC-PRO MP-6VIP-C2

The following is a list of IRQ's (Interrupt ReQuests), which can be exempted much as the COM ports and LPT ports above can. When an I/O device wants to gain the attention of the operating system, it signals this by causing an IRQ to occur. When the operating system is ready to respond to the request, it interrupts itself and performs the service. When set On, activity will neither prevent the system from going into a power management mode nor awaken it.

- IRQ 3 (COM 2)***
- IRQ 4 (COM 1)***
- IRQ 5 (LPT 2)***
- IRQ 6 (Floppy Disk)***
- IRQ 7 (LPT 1)***
- IRQ 8 (RTC Alarm)***

3. Press <ESC> to return to the Main Menu when you finish setting up all items.

3-5 PNP / PCI CONFIGURATION SETUP

- PNP/PCI CONFIGURATION SETUP allows you to set the system's power saving functions.

Run the PNP/PCI CONFIGURATION SETUP as following:

1. Choose "PNP/PCI CONFIGURATION SETUP" from the Main Menu and a screen with a list of option will appear:

ROM PCI/ISA BIOS
PNP/PCI CONFIGURATION
AWARD SOFTWARE, INC.

PNP OS Installed : No	CPU to PCI Write Buffer : Enabled
Resources Controlled By : Auto	PCI Dynamic Bursting : Enabled
Reset Configuration Data : Disabled	PCI Master 0 WS Write : Enabled
IRQ-3 assigned to : PCI/ISA PnP	PCI Delay Transaction : Enabled
IRQ-4 assigned to : PCI/ISA PnP	PCI#2 Access #1 Retry : Disabled
IRQ-5 assigned to : PCI/ISA PnP	AGP Master 1 WS Write : Disabled
IRQ-7 assigned to : PCI/ISA PnP	AGP Master 1 WS Read : Disabled
IRQ-9 assigned to : PCI/ISA PnP	PCI IRQ Activated By : Level
IRQ-10 assigned to : PCI/ISA PnP	Assign IRQ For USB : Enabled
IRQ-11 assigned to : PCI/ISA PnP	Assign IRQ For VGA : Enabled
IRQ-12 assigned to : PCI/ISA PnP	
IRQ-14 assigned to : PCI/ISA PnP	
IRQ-15 assigned to : PCI/ISA PnP	
DMA-0 assigned to : PCI/ISA PnP	
DMA-1 assigned to : PCI/ISA PnP	Esc : Quit ↑ ↓ → ← : Select Item
DMA-3 assigned to : PCI/ISA PnP	F1 : Help PU/PD/+/- : Modify
DMA-5 assigned to : PCI/ISA PnP	F5 : Old Value (Shift) F2 : Color
DMA-6 assigned to : PCI/ISA PnP	F7 : Load Setup Defaults
DMA-7 assigned to : PCI/ISA PnP	

2. Use one of the arrow keys to move between options and modify the selected options by using PgUp / PgDn / + / - keys. An explanation of the <F> keys follows:

<F1>: "Help" gives oions available for each item.

<Shift> + <F2>: Change color.

<F5>: Get the previous values. These values are the values with which the user started in the current session.

<F6>: Load all options with the BIOS default values.

<F7>: Load all options with the Setup default values.

MAGIC-PRO MP-6VIP-C2

PNP OS Installed Yes: OS supports Plug and Play function.
No (default): OS doesn't support Plug and Play function.

NOTE: *BIOS will automatically disable all PnP resources except the boot device card when you select Yes on Non-PnP operating system.*

Resource Controlled Choose Manual (default) or Auto. The BIOS checks
By the IRQ / DMA channel number on the ISA and PCI card manually if you choose Manual and the IRQ / DMA channel number will be checked automatically if you choose Auto.

Reset Configuration Choose Enabled or Disabled (default). Disabled re-
Data **tains** PnP configuration data in BIOS and Enabled **resets** the PnP configuration data in BIOS.

IRQ-x assigned to / Legacy ISA: Manually assigns IRQ / DMA to device.
DMA-x assigned to PCI / ISA PnP: BIOS automatically assigns IRQ / DMA to device.

Assign IRQ for USB Enabled (default): Add one IRQ to USB controller.
Disabled: Remove IRQ from USB controller. The system will have extra IRQ for other devices but the USB controller will still not be disabled. (only IRQ was removed)

Assign IRQ for VGA Enabled (default): Add one IRQ to VGA controller.
Disabled: Remove IRQ from USB controller. The system will have extra IRQ for other devices but the VGA controller will still not be disabled. (only IRQ was removed)

3. Press <ESC> to return to the Main Menu when you finish setting up all items.

3-6 LOAD SETUP DEFAULTS

- LOAD SETUP DEFAULTS option loads the default system values to the system configuration fields. If the CMOS is corrupted, the defaults are loaded automatically.

Choose "LOAD SETUP DEFAULTS" and the following message will appear:

```
  ` Load Setup Defaults  (Y / N) ?   N  `
```

To use the setup defaults, change the prompt to "Y" and press <Enter> key.

3-7 CPU SPEED SETTING

- CPU SPEED SETTING option allows you to get some informations inside your system when it is working.

Run the CPU SPEED SETTING as following:

1. Choose "CPU SPEED SETTING" from the Main Menu and a screen with a list of option will appear:

ROM PCI/ISA BIOS
CPU SPEED SETUP
AWARD SOFTWARE, INC.

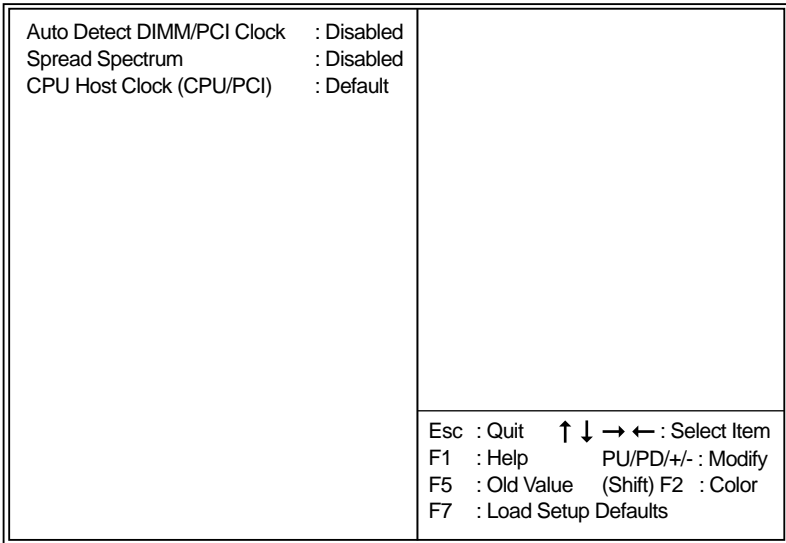

2. Use one of the arrow keys to move between options and modify the selected options by using PgUp / PgDn / + / - keys. An explanation of the <F> keys follows:

<F1>: "Help" gives oions available for each item.

<Shift> + <F2>: Change color.

<F5>: Get the previous values. These values are the values with which the user started in the current session.

<F6>: Load all options with the BIOS default values.

<F7>: Load all options with the Setup default values.

Auto Detect DIMM / PCI Clock Choose Disabled (default) or Enabled. The clock generator will turn off the DIMM clock if this slot is empty.

Spread Spectrum Choose Disabled (default) or Enabled. This function is designed to EMI test only.

CPU Host Clock (CPU / PCI) Select the CPU Host Clock.
The choice: default, 66/33MHz, 75/37MHz, 83/41MHz, 124/31MHz, 133/33MHz, 140/35MHz, and 150/37MHz.

3. Press <ESC> to return to the Main Menu when you finish setting up all items.

3-8 INTEGRATED PERIPHERALS

- INTEGRATED PERIPHERALS option allows you to get some informations inside your system when it is working.

Run the INTEGRATED PERIPHERALS as following:

1. Choose “INTEGRATED PERIPHERALS” from the Main Menu and a screen with a list of option will appear:

ROM PCI/ISA BIOS
INTEGRATED PERIPHERALS
AWARD SOFTWARE, INC.

OnChip IDE Channel0 : Enabled	Onboard Parallel Port : 378/IRQ7
OnChip IDE Channel1 : Enabled	Parallel Port Mode : ECP/EPP
IDE Prefetch Mode : Enabled	ECP Mode Use DMA : 3
Primary Master PIO : Auto	EPP Mode Select : EPP1.7
Primary Slave PIO : Auto	POWER ON Function :
Secondary Master PIO : Auto	KB Power ON Password : Enter
Secondary Slave PIO : Auto	Hot Key Power On : Ctrl - F1
Primary Master UDMA : Auto	
Primary Slave UDMA : Auto	
Secondary MasterUDMA : Auto	
Secondary Slave UDMA : Auto	
Init Display First : PCI Slot	
KBC input clock : 8 MHz	
Onboard FDC Controller : Enabled	
Onboard Serial Port 1 : 3F8/IRQ4	
Onboard Serial Port 2 : 2F8/IRQ3	
UART Mode Select :	Esc : Quit ↑ ↓ → ← : Select Item
UART2 Duplex Mode : Half	F1 : Help PU/PD/+/- : Modify
RxD, TxD Active : Lo, Lo	F5 : Old Value (Shift) F2 : Color
IR Transmission delay : Disabled	F7 : Load Setup Defaults

2. Use one of the arrow keys to move between options and modify the selected options by using PgUp / PgDn / + / - keys. An explanation of the <F> keys follows:

<F1>: “Help” gives oions available for each item.

<Shift> + <F2>: Change color.

<F5>: Get the previous values. These values are the values with which the user started in the current session.

<F6>: Load all options with the BIOS default values.

<F7>: Load all options with the Setup default values.

- OnChip IDE Channel 0 / 1** The chipset contains a PCI IDE interface with support from two IDE channels. Select Enabled to activate the first and/or the second IDE interface. Select Disabled to deactivate an interface if you install a primary and/or second add-on IDE interface.
The choice: Enabled (default), Disabled.
- Primary Master / Slave PIO** Choose Auto (default) or Mode 0~4. The BIOS will detect the HDD mode type automatically when you choose Auto. You need to set to a lower mode than Auto when your hard disk becomes unstable.
Secondary Master / Slave PIO
The choice: Auto, Mode 0, Mode 1, Mode 2, Mode 3, Mode 4.
- Primary Master / Slave UDMA** Ultra DMA/66 implementation is possible only if your IDE hard drive supports it and the operating environment includes a DMA drive and your system software both support Ultra DMA/66, select Auto to enable BIOS support.
Secondary Master / Slave UDMA
The choice: Auto, Disabled.
- IDE Prefetch Mode** The onboard IDE drive interfaces supports IDE prefetching for faster drive accesses. If you install a primary and/or secondary add-in IDE interfaces, set this field to Disabled if the interface does not support prefetching.
The choice: Enabled, Disabled.
- Init Display First** This option allows you to decide to activate PCI Slot or AGP first.
The choice: PCI Slot (default), AGP.
- KBC input clock** This item allows you to set up the I/O keyboard controller for the clock frequency.
The choice: 6MHz, 8MHz, 12MHz, 16MHz.
- Onboard FDC Controller** Select Enabled if your system has a floppy drive controller (FDC) installed on the system board and you want to use it. If you install add-in FDC or the system has no floppy drive, select Disabled in this field.
The choice: Enabled, Disabled.

MAGIC-PRO MP-6VIP-C2

- Onboard Serial Port 1 / Port2** Select an address and corresponding interrupt for the first and second serial ports.
The choice: 3F8/IRQ4, 2E8/IRQ3, 3E8/IRQ4, 2F8/IRQ3, Disabled, Auto.
- UART Mode Select** This item allows you to select UART mode.
The choice: Enabled, Disabled.
- UART2 Duplex Mode** This item allows you to select the IR half / full duplex function.
The choice: Half, Full.
- RxD, TxD Active** This item allows you to determine the active of RxD, TxD.
The choice: "Hi, Hi", "Hi, Lo", "Lo, Lo", "Lo, Hi".
- IR Transmission delay** This item allows you to enable / disable IR transmission delay.
The choice: Enabled, Disabled.
- Onboard Parallel Port** This item allows you to determine onboard parallel port controller I/O address setting.
The choice: 378H/IRQ7, 278H/IRQ5, 3BC/IRQ7, Disabled.
- Parallel Port Mode** Select an operating mode for the onboard parallel (printer) port. Select Normal, Compatible, or SPP unless you are certain your hardware and software both support one of the other available modes.
The choice: SPP, EPP, ECP, ECP + EPP.
- ECP Mode Use DMA** Select a DMA channel for the parallel port for use during ECP mode.
The choice: 3, 1.
- EPP Mode Select** Select EPP port type 1.7 or 1.9
The choice: EPP1.7, 1.9.

KB Power ON Password When user sets a password for keyboard, the password that user set returns the system to Full On state.

Hot Key Power On Boot up the system via predetermined keyboard hot key.
The choice: <Ctrl> + <F1>...<F12>.

3. Press <ESC> to return to the Main Menu when you finish setting up all items.

3-9 SUPERVISOR / USER PASSWORD

- These two options allow you to set your system passwords. Normally, the supervisor has a higher ability to change the CMOS setup option than the user. The way to set up the passwords for both Supervisor and User are as follows:

1. Choose "Change Password" in the Main Menu and press <Enter>. The following message appears:

"Enter Password : "

2. The first time you run this option, enter your password up to 8 characters and press <Enter>. The screen does not display the entered characters.
3. After you enter the password, the following message appears prompting you to confirm the password:

"Confirm Password : "

4. Enter the same password "exactly" as you just typed again to confirm the password and press <Enter>.
5. Move the cursor to Save & Exit Setup to save the password.
6. If you need to delete the password you entered before, choose the Supervisor Password and press <Enter>. It will delete the password that you had before.
7. Move the cursor to Save & Exit Setup to save the option you did, otherwise the old password will still be there the next time you turn your system on.
8. Press <Enter> to exit to the Main Menu.

NOTE: If you forget or lose the password, the only way to access the system is to clear the CMOS RAM. All setup information will be lost and you need to run the BIOS setup program again.

3-10 HDD AUTO DETECTION

- IDE HDD AUTO DETECTION option can automatically detect and find the parameters of IDE Hard Drive. Meanwhile, the informations that BIOS detected will record to the STANDARD CMOS SETUP screen.
- The screen will request you to select a specific Hard Drive for Primary Master after you select this option. If you accept a Hard Drive detected by the BIOS, you can press "Y" to confirm and then press <Enter> to check next Hard Drive. This function allows you to check four Hard Drives and you may press <ESC> after the <Enter> to skip this function and go back to the Main Menu.

3-11 SAVE & EXIT SETUP

- SAVE & EXIT SETUP allows you to save all modifications you have specified into the CMOS memory. Highlight this option on the Main Menu and the following message appears:

"SAVE to CMOS and EXIT (Y/N) ? Y "

Press <Enter> key to save the configuration changes.

3-12 EXIT WITHOUT SAVING

- EXIT WITHOUT SAVING option allows you to exit the Setup Utility without saving the modifications that you have specified. Highlight this option on the Main Menu and the following message appears:

"Quit Without Saving (Y/N) ? N "

You may change the prompt to "Y" and press <Enter> key to leave this option .