

MODEL : MAGIC-PRO MP-586VIP-3

EDITION : May, 1998

VERSION : 2.0

Federal Communications Commission Statement

This device complies with FCC Rules Part 15. Operation is subject to the following two conditions:

- ♦ This device may not cause harmful interference
- ♦ This device must accept any interference received, including interference that may cause undesired operation.

This equipment has been tested and found to comply with the limits for a Class B digital device, pursuant to Part 15 of the FCC Rules. These limits are designed to provide reasonable protection against harmful interference in a residential installation. This equipment generates, uses and can radiate radio frequency energy. If this equipment is not installed and used in accordance with the manufacturer's instructions, it may cause harmful interference to radio communications. However, there is no guarantee that interference will not occur in a particular installation. If this equipment does cause harmful interference to radio or television reception, which can be determined by turning the equipment off and on, the user is encouraged to try to correct the interference by one or more of the following measures:

- ♦ Reorient or relocate the receiving antenna.
- ♦ Increase the separation between the equipment and receiver.
- ♦ Connect the equipment to an outlet on a circuit different from that to which the receiver is connected.
- ♦ Consult the dealer or an experienced radio/TV technician for help.

The use of shielded cables for connection of the monitor to the graphics card is required to assure compliance with FCC regulations. Changes or modifications to this unit not expressly approved by the party responsible for compliance could void the user's authority to operate this equipment.

Canadian Department of Communications Statement

This digital apparatus does not exceed the Class B limits for audio noise emissions from digital apparatuses set out in the Radio Interference Regulations of the Canadian Department of Communications.

Manufacturer's Disclaimer Statement

The information in this document is subject to change without notice and does not represent a commitment on the part of the vendor. No warranty or representation, either expressed or implied, is made with respect to the quality, accuracy or fitness for any particular purpose of this document. The manufacturer reserves the right to make changes to the content of this document and/or the products associated with it at any time without obligation to notify any person or organization of such changes. In no event will the manufacturer be liable for direct, indirect, special, incidental or consequential damages arising out of the use or inability to use this product or documentation, even if advised of the possibility of such damages. This document contains materials protected by copyright. All rights are reserved. No part of this manual may be reproduced or transmitted in any form, by any means or for any purpose without expressed written consent of its authors. Product names appearing in this document are mentioned for identification purposes only. All **trademarks**, product names or brand names appearing in this document are registered property of their respective owners.

Copyright © Magic-Pro Computer Co., LTD.

All rights reserved

Author : Raymond

Printed in Taiwan

May 1998

100% POST-CONSUMER
RECYCLED PAPER 

Table of Contents

Chapter 1: Introduction	1
Key Features	1
Unpacking the Mainboard	2
Electrostatic Discharge Precautions	2
Mainboard Layout w/ Default Settings	3
Chapter 2: Hardware Setup	5
Jumpers	5
JP5: CMOS Clear Jumper	5
JP22: CPU Burst Mode Jumper	6
JP1: Smart Detect CPU Voltage Auto/Manual Jumper	6
JP37: DIMM Voltage Jumper	7
CPU Type Configuration	8
P54C/P55C Series CPUs Settings	8
P54C/P55C Series CPUs Settings (Continued)	9
AMD K5/K6 Series CPUs Setting	10
Cyrix 6x86/L/MX Series CPUs Setting	11
Memory Configuration	12
Memory Configuration Table	12
RAM Bank Installation Notice	12
Cache Configuration	13
Cache Size and RAM Locations	13
Multi I/O Port Addresses	13
Connectors	14
Front Panel Connectors	14
Back Panel Connectors	15
Other Connectors	15
Chapter 3: BIOS Setup	18
Standard CMOS Setup	19
BIOS Features Setup	21
Chipset Features Setup	24
Power Management Setup	26
PNP/PCI Configuration Setup	29
Load Setup Defaults	31
Load BIOS Defaults	31
Integrated Peripherals	32
Supervisor Password	34
User Password	35
IDE HDD Auto Detection	36

Quick Instalation Guide.....	38
Motherboard Layout.....	38
CPU Voltage and Frequency Jumper Settings.....	38
Voltage Settings : JP30.....	38
CPU Frequency Settings : SW1.....	38
Memory Configuration.....	38
Additional Jumper Settings.....	39
Setting for Various Processors : SW1 & JP30.....	39
BIOS Update.....	40

1 Introduction

The **MP-586-VIP3** mainboard is a high-performance ATX system board that supports P54C/P55C family CPUs. This mainboard is fully compatible with industry standards and adds many technical enhancements.

Key Features

- CPU
 - Supports P54C/P55C family CPUs running at 75~233 MHz speeds; Cyrix 6x86/6x86L/6x86MX CPUs running at PR150~PR266 speeds; and AMD K5/K6 CPUs running at P75~PR300 speeds
 - Supports Socket 7 for upgrade
 - Supports P54C/P55C series SMM Mode and CPU Stop Clock
 - Supports **MMX** technology and Smart Detect CPU Voltage function
- L2 Cache Controller
 - On-board **512K/1M** Pipeline Burst SRAMs Cache
- DRAM Controller
 - Supports 2 strips of 72-pin FPM/EDO SIMM (symmetrical/asymmetrical addressing)
 - Supports **3 strips** of 168-pin EDO/SDRM **Unbuffered DIMM**
 - **Comes with three DIMM banks, supports 8/16/32/64/128 MB unbuffered DIMMs**
 - Memory configuration for DIMM is from 8MB to 384 MB; for SIMM is from 8MB to 64MB
- BUS Controller
 - Compliant to PCI specifications v2.1
 - Five 32-bit PCI slots, two ISA slots, and **one AGP slot**
 - **Onboard USB (Universal Serial Bus) port**
- Peripheral Controller
 - System BIOS include NCR 810 SCSI BIOS and Plug&Play func.
 - Onboard PCI Master IDE controller and floppy controller
 - Onboard supports two high speed UARTS (w/i 16550 FIFO), one ECP/EPP/SPP multi-mode parallel port, and one PS/2 mouse port
 - **Onboard FLASH Memory for easy upgrade BIOS**
 - Easy installation of ETEQ E-IDE/ATAPI CD-ROM Bus Master Drivers included
 - Onboard support IR connector

Unpacking the Mainboard

The mainboard package contains:

- The Mainboard
- One CD (Including Manuals/Drivers/Utilities)
- One page of One Sheet Manual

Note: Do not unpack the mainboard until you are ready to install it.

Follow the precautions below while unpacking the mainboard.

1. Before handling the mainboard, ground yourself by grasping an unpainted portion of the system's metal chassis.
2. Remove the mainboard from its anti-static packaging and place it on a grounded surface, component side up.
3. Check the mainboard for damage. If any chip appears loose, press carefully to seat it firmly in its socket.

Do not apply power if the mainboard appears damaged. If there is damage to the board contact your dealer immediately.

Electrostatic Discharge Precautions

Make sure you ground yourself before handling the mainboard or other system components. Electrostatic discharge can easily damage the components. Note that you must take special precaution when handling the mainboard in dry or air-conditioned environments.

Take these precautions to protect your equipment from electrostatic discharge:

- Do not remove the anti-static packaging until you are ready to install the mainboard and other system components.
- Ground yourself before removing any system component from its protective anti-static packaging. To ground yourself grasp the expansion slot covers or other unpainted portions of the computer chassis.
- Frequently ground yourself while working, or use a grounding strap.
- Handle the mainboard by the edges and avoid touching its components.

Mainboard Layout w/ Default Settings

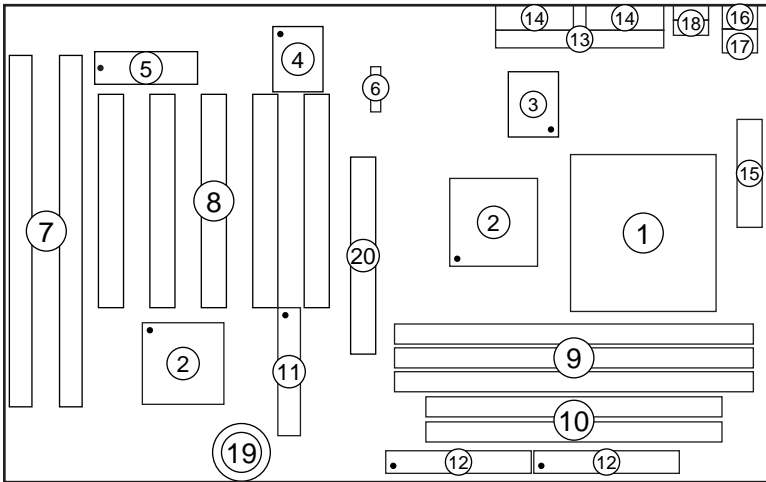

Figure 1-1. Mainboard Layout

- | | |
|----------------------------|-----------------------------|
| 1. ZIF socket 7 | 11. Floppy Connector |
| 2. VIA VP3 Chipset | 12. IDE1/IDE2 Connector |
| 3. Pipelined Burst SRAM | 13. Parallel Port Connector |
| 4. Super I/O Chip | 14. COM1/COM2 Connector |
| 5. PnP FLASH BIOS | 15. ATX Power Connector |
| 6. 1 TAG SRAM (or 2 SRAMs) | 16. PS/2 KB Connector |
| 7. ISA Slots | 17. PS/2 Mouse Connector |
| 8. PCI Slots | 18. USB Connectors |
| 9. Unbuffered DIMM Bank | 19. 3 Volt. Lithium Battery |
| 10. SIMM Bank | 20. AGP Port |

Default settings are as follows: Pentium 133MHz (P54C/P55C) CPU, 512K Pipelined Burst cache, On - board PCI E - IDE Enabled, 2 high speed UARTS Enabled (w / 16550 FIFO), 1 EPP/ECP port (ECP + EPP mode), 5V DRAM/3.3V DIMM, and ATX power supply.

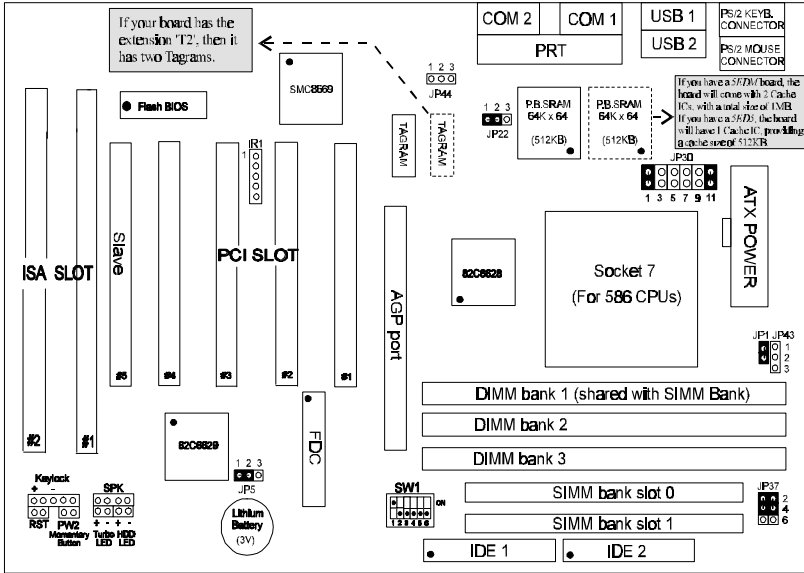

Figure 1-2. Mainboard Default Setting

Important: Make sure the system is well ventilated to prevent overheating and ensure system stability.

2 Hardware Setup

This chapter is designed for Normal edition mainboard use only and it explains how to configure the mainboard's hardware. After you install the mainboard, you can set jumpers, install memory on the mainboard, and make case connections. Refer to this chapter whenever you upgrade or reconfigure your system.

CAUTION: *Turn off power to the mainboard, system chassis, and peripheral devices before performing any work on the mainboard or system.*



















Jumpers

This mainboard uses different colors of jumper caps to identify different functions of the jumpers:

Jumper Cap Color	White	Black	Blue	Red	Green
Function	clear CMOS	CPU burst mode	Smart Detect CPU voltage	DIMM voltage	CPU Voltage



JP5: CMOS Clear Jumper

Clear the CMOS memory by momentarily shorting pin 2–3; then shorting pin 1–2 to retain new settings.

CMOS Setting	JP5						
Retain CMOS data (default)	<table><tr><td>1</td><td>2</td><td>3</td></tr><tr><td></td><td></td><td></td></tr></table>	1	2	3			
1	2	3					
							
Clear CMOS data	<table><tr><td>1</td><td>2</td><td>3</td></tr><tr><td></td><td></td><td></td></tr></table>	1	2	3			
1	2	3					
							

JP22: CPU Burst Mode Jumper

Due to different designs, there are two kinds of CPU burst modes: Interleave Burst and Linear Burst. Select the correct mode according to the CPU you are using.

CPU Burst Mode	JP22
Interleave (for P54C/P55C and AMD K5/K6 CPU)	1 2 3 
Linear (for Cyrix 6x86/L/MX CPU)	1 2 3 

When using a Cyrix series of CPUs, follow the below procedures after select the burst mode:

1. Press <Delete> key to enter the BIOS setup menu during the boot-up,
2. Select “Chipset Features Setup”,
3. Set the “Linear Burst” to “Enabled”,
4. Press <Esc> to go back to the main menu and choose “Save & Exit Setup” to reboot your computer.

JP1: Smart Detect CPU Voltage Auto/Manual Jumper

For P54C/P55C and Cyrix 6x86/L CPUs, this board automatically detects and adjusts the CPU voltage to the proper voltage. JP1 is reserved for a few older non-Intel CPUs which can not be detect correctly. If you run into problems while detecting the voltage of older CPUs, remove the jumper cap to correct it.

JP37: DIMM Voltage Jumper

There are two kinds of DIMM voltages in the market—3.3V and 5V—and most of SDRAM DIMMS are 3.3V. Choose the correct voltage according to the DIMM that you are using.

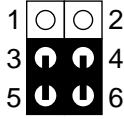
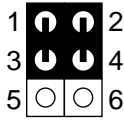
DIMM Voltage	JP37 Setting
5V	
3.3V (Default)	

Caution: *Do not change this jumper to 5V setting unless you are sure that your DIMMs are 5V. The wrong setting may cause the system malfunction.*

CPU Type Configuration

SW1 and JP30 are the only switches/jumpers that you need to set for your CPU on this mainboard. Make sure that you know the type of CPU that you are installing and refer to the proper settings which are listed below. If you have a higher frequency CPU then the one listed below, see the “Quick Installation Guide” for more SW1 information.

- SW1: Frequency Setting.** Some newer CPUs may not be included in this section, please refer to the Appendix for more information.
- JP30: Voltage Setting.** There are two kinds of CPU voltages currently on the market—Single and Dual. The CPUs which fall under the single voltage category are: P54C, AMD-K5, and Cyrix 6x86. The CPUs which fall under the dual voltage category are: P55C, AMD-K6, and Cyrix 6x86L/MX. This board is designed to detect the CPU voltage automatically for P54C and P55C CPUs due to the Smart Detect CPU Voltage function, and therefore, there is no need to move any jumpers to set the voltage for P54C/P55C CPUs.

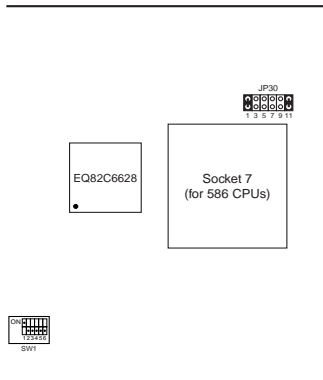













Figure 2–1. Location of JP30 and SW1

P54C/P55C Series CPUs Settings

CPU	Frequency Setting (SW1)	Voltage Setting (JP30)
P54C–75MHz	External : 50MHz Ratio : 1.5x	Single Voltage 3.52V (default)
P54C–90MHz	External : 60MHz Ratio : 1.5x	
P54C–100MHz	External : 66MHz Ratio : 1.5x	

P54C/P55C Series CPUs Settings (Continued)

CPU	Frequency Setting (SW1)	Voltage Setting (JP30)
P54C-120MHz	 External : 60MHz Ratio : 2.0x	 JP30 Single Voltage 3.52V (default)
P54C-133MHz (default)	 External : 66MHz Ratio : 2.0x	
P54C-150MHz	 External : 60MHz Ratio : 2.5x	
P54C-166MHz	 External : 66MHz Ratio : 2.5x	
P54C-180MHz	 External : 60MHz Ratio : 3.0x	
P54C-200MHz	 External : 66MHz Ratio : 3.0x	
P55C-166MHz (MMX)	 External : 66MHz Ratio : 2.5x	 JP30 DualVoltage 2.8V (default)
P55C-180MHz (MMX)	 External : 60MHz Ratio : 3.0x	
P55C-200MHz (MMX)	 External : 66MHz Ratio : 3.0x	
P55C-233MHz (MMX)	 External : 66MHz Ratio : 3.5x	





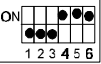
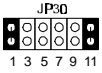
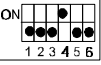
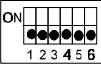
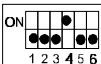
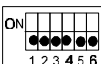
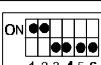
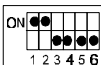
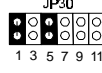
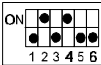
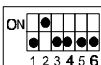
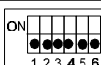
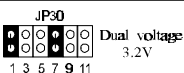
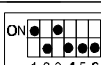
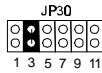
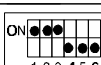





Note: The voltage setting for 3.52V and 2.8V are the same due to the Smart Detect CPU Voltage technology.

AMD K5/K6 series CPUs setting

CPU	Frequency setting (SW1)	Voltage setting (JP30)
AMD-K5 PR75	 External : 50MHz Ratio : 1.5x	 Single voltage 3.52V (default)
AMD-K5 PR90	 External : 60MHz Ratio : 1.5x	
AMD-K5 PR100	 External : 66MHz Ratio : 1.5x	
AMD-K5 PR120	 External : 60MHz Ratio : 1.5x	
AMD-K5 PR133	 External : 66MHz Ratio : 1.5x	
AMD-K5 PR166	 External : 66MHz Ratio : 2.5x	
AMD-K6 PR166	 External : 66MHz Ratio : 2.5x	 Dual voltage 2.9V
AMD-K6 PR180	 External : 60MHz Ratio : 3.0x	
AMD-K6 PR200	 External : 66MHz Ratio : 3.0x	
AMD-K6 PR233	 External : 66MHz Ratio : 3.5x	 Dual voltage 3.2V
AMD-K6 PR266	 External : 66MHz Ratio : 4.0x	 Dual voltage 2.2V
AMD-K6 PR300	 External : 66MHz Ratio : 4.5x	

Note : The voltage of AMD may vary from market to market. Please ask your CPU provider for detail. We follow the specification of AMD. AMD has the right to change the specification without notice.

Cyrrix 6x86/L/MX Series CPUs Setting

CPU	Frequency Setting (SW1)	Voltage Setting (JP30)
Cyrrix 6x86/6x86L -PR150	 External : 60MHz Ratio : 2.0x	JP30  JP30 1 3 5 7 9 11
Cyrrix 6x86/6x86L -PR166	 External : 66MHz Ratio : 2.0x	Single Voltage : 3.52V (default) Dual Voltage : 2.8V (default)
Cyrrix 6x86/6x86L -PR200	 External : 75MHz Ratio : 2.0x	
Cyrrix 6x86MX -PR166	 External : 60MHz Ratio : 2.5x	
Cyrrix 6x86MX -PR200	 External : 66MHz Ratio : 2.5x	JP30  JP30 1 3 5 7 9 11 Dual Voltage : 2.9V
Cyrrix 6x86MX -PR233	 External : 75MHz Ratio : 2.5x	
Cyrrix 6x86MX -PR233	 External : 66MHz Ratio : 3.0x	
Cyrrix 6x86MX -PR266	 External : 75MHz Ratio : 3.0x	
Cyrrix 6x86MX -PR266	 External : 66MHz Ratio : 3.5x	

- Note: 1. There are two kinds of Cyrrix MX-PR233/266 CPUs as you could see on the above list. Make sure the type of your CPU first from your CPU provider and then set the SW1 and JP30.
2. The voltage setting for 3.52V and 2.8V are the same due to the Smart Detect CPU Voltage technology.

Memory Configuration

The mainboard supports one bank of **72-pin 5V FPM/EDO/Burst EDO DRAM (SIMM)**, and **three strips of 168-pin 3.3V/5V Unbuffered DIMM modules**. The mainboard requires SIMM of at least 70ns access time.

The mainboard supports SIMM bank and DIMM banks from 4 to 128 MB with no other restrictions on memory configurations. You can install memory in any combination without having to rely on a memory configuration table. Memory configuration is thus “**Table-Free**” in any memory bank. You must install two SIMM modules to complete a bank.

Memory Configuration Table

	SIMM Bank	DIMM Bank		
	Bank 0	DIMM 1	DIMM 2	DIMM 3
RAM Type	FPM/EDO	FPM/BEDO /SDRAM	FPM/EDO/ SDRAM	FPM/EDO/ SDRAM
Single RAM Module Size (MB)	4/8/16/32/64	4/8/16/32/64 /128	4/8/16/32/64 /128	4/8/16/32/64 /128

Note: Do not install FPM or EDO SIMM/DIMM when you already installed SDRAM type of DIMM.

RAM Bank Installation Notice

Due to the RAS line share architecture of ETEQ chipset, do not install SIMM bank with DIMM1. All other combinations are acceptable.

Cache Configuration

The mainboard has a write-back caching scheme with built-in 512KB or 1MB Level 2 Pipelined Burst cache onboard to improve the system performance.

L2 Cache Size and RAM Locations

Cache Size	Cache RAM	TAG RAM	Cacheable Range
512KB	64k x 64 on U4	16K x 8 on U11 (1 tag)	64 MB (1 dirty bit) 128 MB (0 dirty bit) *
		16K x 8 on U11,U10 (2 tags)	256 MB (1 dirty bit) * 512 MB (0 dirty bit) *
1MB	64k x 64 U4, U8	16K x 8 on U11 (1 tag)	128 MB (1 dirty bit) * 256 MB (0 dirty bit) *
		16K x 8 on U11,U10 (2 tags)	512 MB (1 dirty bit) * 512 MB (0 dirty bit) *

* :1. The performance of 1MB cache is better than 512KB cache even the cacheable range is the same.

2. You could change the dirty bit from item "Sustained 3T Write" or "Dirty bit" in "Chipset Feature Setup" sub-menu of BIOS setup and "Enabled" means dirty bit set to 0, "Disabled" means dirty bit set to 1.

Multi I/O Port Addresses

Default settings for multi-I/O port addresses are shown in the table below.

Port	I/O Address	IRQ	Mode
LPT1*	378H	7	ECP + EPP
COM1	3F8H	4	
COM2	2F8H	3	

If default I/O port addresses conflict with other I/O cards (e.g. sound cards or I/O cards), you must adjust one of the I/O addresses to avoid address conflict. (You can adjust these I/O addresses from the BIOS setup.)

Note: Some sound cards have a default IRQ setting for IRQ7, which may conflict with printing functions. If this occurs do not use sound card functions at the same time you print.

Connectors

Attach the mainboard to case devices via connectors on the mainboard. Refer to Figure 1-1 for connector locations and connector pin positions.

Front Panel Connectors

Connector's Name	Description
HD LED	IDE device LED connector: Attach a 2-pin IDE drive LED cable to this connector. The LED lights when an IDE device is active.
KB_LOCK	Keylock & Power LED connector: It is a 5-pin connector for a lock that may be installed on the system case for enabling or disabling the keyboard. It also attaches to the case's Power LED. Pin 1, 3 are for power LED and pin 4, 5 are for keylock.
PW2	ATX power on/off switch connector: Attach a 2-pin momentary type switch to this connector for turning on or off your ATX power supply.
RESET	Hardware reset switch connector: Attach 2-pin hardware reset switch to it. Closing the reset switch restarts the system.
SPEAK	PC speaker connector: Attach a 4-pin PC speaker cable from the case to this connector.
TB LED	Turbo LED connector: Attach a 2-pin turbo LED cable to it. The LED lights when the system is in turbo mode. Manufacture default has set the board in turbo mode due to most of hardware and software are compliance to turbo mode.

Back Panel Connectors

Connector's Name	Description
COM1/ COM2	COM1/COM2 serial port connectors: Attach COM1/COM2 device cables to these connectors.
PS/2 Keyboard Connector	PS/2 keyboard port connector: A 6-pin female PS/2 keyboard connector is located at the rear of the board. Plug the PS/2 keyboard jack into this connector.
PRT	Parallel port connector: A 26-pin female connector is located at the rear of the board. Plug the parallel port device cable into this connector.
USB1/2	USB ports connectors: Two female connector is located at the rear of the board. Plug the USB devices jack into this connector.

Other Connectors

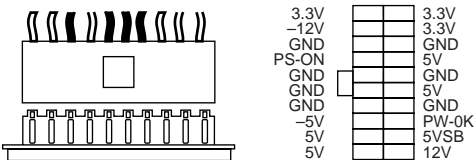
Connector's Name	Description																				
ATX PW	<p>ATX power supply connector: It is a twenty-pin male header connector. Plug the connector from the power directly onto the board connector while making sure the pin1 is in its position. The mainboard requires a power supply with at least 200 watts and a “power good” signal.</p>  <p>The diagram shows a 20-pin male header connector with a notch on the left side. To its right is a 20-pin female header with the following pinout:</p> <table border="1"> <tr><td>3.3V</td><td>3.3V</td></tr> <tr><td>-12V</td><td>3.3V</td></tr> <tr><td>GND</td><td>GND</td></tr> <tr><td>PS-ON</td><td>5V</td></tr> <tr><td>GND</td><td>GND</td></tr> <tr><td>GND</td><td>5V</td></tr> <tr><td>GND</td><td>GND</td></tr> <tr><td>-5V</td><td>PW-0K</td></tr> <tr><td>5V</td><td>5VSB</td></tr> <tr><td>5V</td><td>12V</td></tr> </table>	3.3V	3.3V	-12V	3.3V	GND	GND	PS-ON	5V	GND	GND	GND	5V	GND	GND	-5V	PW-0K	5V	5VSB	5V	12V
3.3V	3.3V																				
-12V	3.3V																				
GND	GND																				
PS-ON	5V																				
GND	GND																				
GND	5V																				
GND	GND																				
-5V	PW-0K																				
5V	5VSB																				
5V	12V																				
	<p><i>Note:</i> Make sure that the ATX power supply can take at least 10mAmp load on the 5V StandBy lead (5VSB) to meet the standard ATX specification.</p>																				

Fan (JP43)	<p>CPU cooling fan connector: Attach a 3-pin CPU cooling fan cable to this connector. Make sure the pin assignment of the fan matches this connector or you may damage the system. This fan will stop when the system is into the suspend mode, if you enable the Suspend Mode in the BIOS setup.</p> <div data-bbox="558 341 742 579" style="border: 1px solid black; padding: 5px; margin: 10px auto; width: fit-content;"> <p style="text-align: center;">CPU Cooling Fan Pin Assignment</p> <table style="width: 100%; border-collapse: collapse;"> <tr> <td style="text-align: center; width: 20px;">1</td> <td style="text-align: center; width: 20px;">⊖</td> <td style="border-left: 1px solid black; width: 10px;"></td> <td style="text-align: center;">GND</td> </tr> <tr> <td style="text-align: center;">2</td> <td style="text-align: center;">⊖</td> <td style="border-left: 1px solid black;"></td> <td style="text-align: center;">12V</td> </tr> <tr> <td style="text-align: center;">3</td> <td style="text-align: center;">⊖</td> <td style="border-left: 1px solid black;"></td> <td style="text-align: center;">Empty</td> </tr> </table> </div>	1	⊖		GND	2	⊖		12V	3	⊖		Empty								
1	⊖		GND																		
2	⊖		12V																		
3	⊖		Empty																		
IDE1/IDE2	<p>Primary/Secondary IDE device connectors: Attach the IDE device cables to these connectors.</p>																				
IR	<p>Infrared device connector: Attach a 5-pin infrared device cable to this connector for enabling the infrared transfer function. This mainboard meets the specification of ASKIAR and HPSIR.</p> <div data-bbox="558 794 742 1067" style="border: 1px solid black; padding: 5px; margin: 10px auto; width: fit-content;"> <p style="text-align: center;">IR Connector Pin Assignment</p> <table style="width: 100%; border-collapse: collapse;"> <tr> <td style="text-align: center; width: 20px;">1</td> <td style="text-align: center; width: 20px;">⊖</td> <td style="border-left: 1px solid black; width: 10px;"></td> <td style="text-align: center;">VCC</td> </tr> <tr> <td style="text-align: center;">2</td> <td style="text-align: center;">⊖</td> <td style="border-left: 1px solid black;"></td> <td style="text-align: center;">Empty</td> </tr> <tr> <td style="text-align: center;">3</td> <td style="text-align: center;">⊖</td> <td style="border-left: 1px solid black;"></td> <td style="text-align: center;">IRRX</td> </tr> <tr> <td style="text-align: center;">4</td> <td style="text-align: center;">⊖</td> <td style="border-left: 1px solid black;"></td> <td style="text-align: center;">GND</td> </tr> <tr> <td style="text-align: center;">5</td> <td style="text-align: center;">⊖</td> <td style="border-left: 1px solid black;"></td> <td style="text-align: center;">IRTX</td> </tr> </table> </div>	1	⊖		VCC	2	⊖		Empty	3	⊖		IRRX	4	⊖		GND	5	⊖		IRTX
1	⊖		VCC																		
2	⊖		Empty																		
3	⊖		IRRX																		
4	⊖		GND																		
5	⊖		IRTX																		

JP44	<p>Wake-on-LAN connector: Attach a 3-pin connector from the LAN card which supports the Wake-On-LAN (WOL) function. This function lets users wake up the connected computer through the LAN card. (The cable should be included with the LAN card.)</p> <div data-bbox="558 312 742 587" style="border: 1px solid black; padding: 5px; margin: 10px auto; width: fit-content;"><p style="text-align: center;">Wake-on-LAN Pin Assignment</p><table style="margin: auto;"><tr><td style="text-align: center;">5V</td><td style="text-align: center;">GND</td><td style="text-align: center;">SENSOR</td></tr><tr><td style="text-align: center;">⊖</td><td style="text-align: center;">⊖</td><td style="text-align: center;">⊖</td></tr><tr><td style="text-align: center;">1</td><td style="text-align: center;">2</td><td style="text-align: center;">3</td></tr></table></div>	5V	GND	SENSOR	⊖	⊖	⊖	1	2	3
5V	GND	SENSOR								
⊖	⊖	⊖								
1	2	3								

3 BIOS Setup

The mainboard's BIOS setup program is the ROM PCI/ISA BIOS from Award Software Inc. Enter the Award BIOS program's Main Menu as follows:

1. Turn on or reboot the system. After a series of diagnostic checks, you are asked to press DEL to enter Setup.
2. Press the key to enter the Award BIOS program and the main screen appears:

ROM PCI/ISA BIOS
CMOS SETUP UTILITY
AWARD SOFTWARE, INC.

STANDARD CMOS SETUP	INTEGRATED PERIPHERALS
BIOS FEATURES SETUP	SUPERVISOR PASSWORD
CHIPSET FEATURES SETUP	USER PASSWORD
POWER MANAGEMENT SETUP	IDE HDD AUTO DETECTION
PNP/PCI CONFIGURATION	SAVE & EXIT SETUP
LOAD SETUP DEFAULTS	EXIT WITHOUT SAVING
LOAD BIOS DEFAULTS	
Esc : Quit	↑ ↓ → ← : Select Item
F10 : Save & Exit Setup	(Shift) F2 : Change Color
Time, Date, Hard Disk Type...	

3. Choose an option and press <Enter>. Modify the system parameters to reflect the options installed in the system. (See the following sections.)
4. Press <ESC> at anytime to return to the Main Menu.
5. In the Main Menu, choose "SAVE AND EXIT SETUP" to save your changes and reboot the system. Choosing "EXIT WITHOUT SAVING" ignores your changes and exits the program.

The Main Menu options of the Award BIOS are described in the sections that follow.

Standard CMOS Setup

Run the Standard CMOS Setup as follows.

1. Choose "STANDARD CMOS SETUP" from the Main Menu. A screen appears.

ROM PCI/ISA BIOS
STANDARD CMOS SETUP
AWARD SOFTWARE, INC.

Date (mm:dd:yy) : Fri, Feb 1 1995																	
Time (hh:mm:ss) : 7 : 30 : 33																	
HARD DISKS	TYPE	SIZE	CYLS	HEAD	PRECOMP	LANDZ	SECTOR	MODE									
Primary Master	: AUTO	0	0	0	0	0	0	AUTO									
Primary Slave	: None	0	0	0	0	0	0	----									
Secondary Master	: None	0	0	0	0	0	0	----									
Secondary Slave	: None	0	0	0	0	0	0	----									
Drive A : 1.44M, 3.5 in.					<table border="1"> <tr> <td>Base Memory:</td> <td>640K</td> </tr> <tr> <td>Extended Memory:</td> <td>3328K</td> </tr> <tr> <td>Other Memory:</td> <td>128K</td> </tr> <tr> <td colspan="2">Total Memory: 4096K</td> </tr> </table>					Base Memory:	640K	Extended Memory:	3328K	Other Memory:	128K	Total Memory: 4096K	
Base Memory:	640K																
Extended Memory:	3328K																
Other Memory:	128K																
Total Memory: 4096K																	
Drive B : None																	
Floppy 3 Mode Support : Disabled																	
Video : EGA/VGA																	
Halt On : All Errors																	
Esc : Quit			↑ ↓ → ← : Select Item			PU/PD/+/- : Modify											
F11 : Help			(Shift) F2 : Change Color			F3 : Toggle Calendar											

2. Use arrow keys to move between items and select values. Modify selected fields using PgUp/PgDn/+/- keys. Some fields let you enter values directly.

Date (mm/dd/yy) Type the current date.

Time (hh:mm:ss) Type the current time.

Primary (Secondary) First, choose the type of hard disk that you already installed:

Master & Slave

- Auto – BIOS detects hard disk type automatically (default)
- 1 ~ 46 – Selects standard hard disk type
- User – User defines the type of hard disk.

Next, choose hard disk mode:

- Auto – BIOS detects hard disk mode automatically (default)
- Normal – Normal IDE hard disk (smaller than 528MB)
- LBA – Enhanced-IDE hard disk (larger than 528MB)

Primary (Secondary) Master & Slave (Continued)	Large – Large IDE hard disk (for certain hard disk) <i>Note: If you have any questions on your hard disk type or mode, ask your hard disk provider or previous user for details.</i>
Drive A & B	Choose 360KB , 5 1/4 in., 1.2MB , 5 1/4 in., 720KB , 3 1/2 in., 1.44M , 3 1/2 in.(default), 2.88 MB, 3 1/2 in. or Not installed
Floppy 3 Mode Support	Choose Disabled (default) or Enabled. When enables this function, the system will support 720KB/1.25MB/1.44MB 3 different modes floppy diskette. <i>Note: This function is for a special disk drive which happens to be popular in Japan.</i>
Video	Choose Monochrome, Color 40x25, VGA/EGA (default), Color 80x25
Halt On	When BIOS detects system errors, this function will stop the system. Choose one of the following options to make system halt. All Errors (default) All, But Diskette No Errors All, But Keyboard All, But Disk/Key

3. When you finish, press the <ESC> key to return to the Main Menu.

BIOS Features Setup

Run the BIOS Features Setup as follows.

1. Choose “BIOS FEATURES SETUP” from the Main Menu and a screen with a list of items appears. (The screen below shows the BIOS default settings.)

ROM PCI/ISA BIOS
BIOS FEATURES SETUP
AWARD SOFTWARE, INC.

CPU Internal Cache	: Enabled	Video BIOS Shadow	: Enabled
External Cache	: Enabled	C8000-CBFFF Shadow	: Disabled
Quick Power on Self Test	: Enabled	CC000-CFFFF Shadow	: Disabled
Boot Sequence	: A,C,SCSI	D0000-D3FFF Shadow	: Disabled
Swap Floppy Drive	: Disabled	D4000-D7FFF Shadow	: Disabled
Boot Up NumLock Status	: On	D8000-DBFFF Shadow	: Disabled
Typematic Rate Setting	: Disabled	DC000-DFFFF Shadow	: Disabled
Typematic Rate (Chars/Sec)	: 6		
Typematic Delay (Msec)	: 250		
Security Option	: Setup	ESC : Quit	↑ ↓ → ← : Select Item
IDE Second Channel Control	: Enabled	F1 : Help	PU/PD/+/- : Modify
PS/2 Mouse Function Control	: Disabled	F5 : Old Values (Shift)	F2 : Color
PCI/VGA Palette Snoop	: Disabled	F6 : Load BIOS Defaults	
OS Select for DRAM >64MB	: Non-OS2	F7 : Load Setup Defaults	

2. Use the arrow keys to move between items and to select values. Modify the selected fields using the PgUp/PgDn/+/- keys. <F> keys are explained below:
 - <F1>: “Help” gives options available for each item.
 - Shift <F2>: Change color.
 - <F5>: Get the old values. These values are the values with which the user started the current session.
 - <F6>: Load all options with the BIOS Setup default values.
 - <F7>: Load all options with the Power-On default values.

A short description of screen items follows:

CPU Internal Cache This option enables/disables the CPU’s internal cache. (The Default setting is Enabled.)

External Cache This option enables/disables the external cache memory. (The Default setting is Enabled.)

Quick Power On Self Test Enabled provides a fast POST at boot-up .

- Boot Sequence** Choose the boot device sequence as your need. For example, “A, C, SCSI” means BIOS will look for an operating system first from drive A, drive C, then SCSI device. Options of this function are:
 A, C, SCSI
 C, A, SCSI
 C, CD-ROM, A
 CD-ROM, C, A
 D, A, SCSI
 E, A, SCSI
 F, A, SCSI
 SCSI, A, C
 SCSI, C, A
 C only.
- Swap Floppy Drive** Enabled changes the sequence of the A: and B: drives. (The Default setting is Disabled.)
- Boot Up Num Lock Status** Choose **On** or **Off**. On puts numeric keypad in Num Lock mode at boot-up. Off puts this keypad in arrow key mode at boot-up.
- Typematic Rate Setting** Enable this option to adjust the keystroke repeat rate.
- Typematic Rate (Chars/Sec)** Choose the rate a character keeps repeating.
- Typematic Delay (Msec)** Choose how long after you press a key that a character begins repeating.
- Security Option** Choose **Setup** or **System**. Use this feature to prevent unauthorized system boot-up or use of BIOS Setup.
- “System” – Each time the system is booted the password prompt appears.
- “Setup” – If a password is set, the password prompt only appears if you attempt to enter the Setup program.

IDE Second Channel Control	Default setting is Enabled. Choose Disabled when you need to turn off the onboard IDE second channel.
PS/2 Mouse Function Control	Default setting is Disabled. You need to enable this function when the PS/2 mouse is attached.
PCI/VGA Palette Snoop	Enabled: The color of the monitor may be incorrect if uses with MPEG card. Enable this option to make the monitor normal. Disabled: Default setting.
OS Select for DRAM >64MB	OS2 – Choosing this when you are using OS/2 operation system. Non-OS/2 – Choosing this when you are using no-OS/2 operation system.
Video or Adapter BIOS Shadow	BIOS shadow copies BIOS code from slower ROM to faster RAM. BIOS can then execute from RAM. These 16K segments can be shadowed from ROM to RAM. BIOS is shadowed in a 16K segment if it is enabled and it has BIOS present.

3. After you have finished with the BIOS Features Setup program, press the <ESC> key and follow the screen instructions to save or disregard your settings.

Chipset Features Setup

The Chipset Features Setup option changes the values of the chipset registers. These registers control system options in the computer.

Note: Change these settings only if you are familiar with the Chipset.

Run the Chipset Features Setup as follows.

1. Choose “CHIPSET FEATURES SETUP” from the Main Menu and the following screen appears. (The screen below shows default settings.)

ROM PCI/ISA BIOS CHIPSET FEATURES SETUP AWARD SOFTWARE, INC.	
Bank 0/1 DRAM Timing	: 60ns
Read Pipeline	: Disabled
Write Pipeline	: Enabled
Video BIOS Cacheable	: Disabled
System BIOS Cacheable	: Disabled
Memory hole At 15Mb Addr.	: Disabled
OnChip USB	: Disabled
ESC : Quit ↑ ↓ → ← : Select Item F1 : Help PU/PD/+/- : Modify F5 : Old Values (Shift) F2 : Color F6 : Load BIOS Defaults F7 : Load Setup Defaults	

2. Use the arrow keys to move between items and select values. Modify selected fields using the PgUp/PgDn/+/- keys.

A short description of screen items follows:

Bank 0/1 DRAM Timing Choose 60ns, 70ns, Normal, Medium, Fast, or Turbo. Normal is the slowest and you must check the system stability before you change to the Fast or Turbo setting. Choose 60ns or 70ns only when you know the exact timing of the DRAM.

DRAM Read Pipeline Use the default setting.

Cache Rd + CPU Wt Pipeline Use the default setting.

Read Around Write Use the default setting.

Linear Burst	Choose Enabled when you installed a Cyrix CPU and set JP22 to Linear mode.
Video BIOS Cacheable	Disabled – The ROM area F0000H-FFFFFH is not cached. Enabled – The ROM area F0000H-FFFFFH is cacheable if cache controller is enabled.
System BIOS Cacheable	Disabled – The video BIOS C0000H-C7FFFH is not cached. Enabled – The video BIOS C0000H-C7FFFH is cacheable if cache controller is enabled.
Memory Hole At 15Mb Addr	Choose Enabled or Disabled (default). Some interface cards will map their ROM address to this area. If this occurs, you should select Enabled, otherwise use Disabled.
AGP	Choose Enabled when you wish to use DRAM to extend the size of your AGP VGA card's VRAM.
AGP Aperture Size	AGP could use the DRAM as its video RAM. Choose the DRAM size that you want it to be used as video RAM. The range is from 4MB to 256MB.
OnChip USB	Default is Disabled. Enable this function when you use the USB device.
USB Keyboard Support	Enable this function when you use the USB keyboard, but notice that you need to use the regular keyboard first before getting in the BIOS setup.

**Spread Spectrum
Modulated**

Choose **Disabled** (default) or Enabled.
Select Enabled when uses Spread
Spectrum Modulated 1.5% or 6% for FCC
or DOC testing.

3. After you have finished with the Chipset Features Setup, press the <ESC> key and follow the screen instructions to save or disregard your settings.

Power Management Setup

The Power Management Setup option sets the system's power saving functions.

Run the Power Management Setup as follows.

1. Choose "POWER MANAGEMENT SETUP" from the Main Menu and a screen with a list of items appears.

ROM PCI/ISA BIOS CMOS SETUP UTILITY POWER MANAGEMENT SETUP	
Power Management : Disabled	** Power Down & Resume Events **
PM Control by APM : Yes	IRQ 5 (LPT 2) : Primary
Video Off Option : Suspend -> Off	IRQ 6 (Floppy Disk) : Primary
Video Off Method : V/H SYNC+Blank	IRQ 7 (LPT 1) : Primary
Conserve Mode : Disabled	IRQ 8 (RTC Alarm) : Disabled
	IRQ 9 (IRQ2 Redir) : Secondary
	IRQ 10 (Reserved) : Secondary
** PM Timers **	IRQ 11 (Reserved) : Secondary
HDD Power Down : Disabled	IRQ 12 (PS/2 mouse) : Primary
Doze Mode : Disabled	IRQ 13 (Coprocessor) : Primary
Suspend Mode : Disabled	IRQ 14 (Hard Disk) : Primary
	IRQ 15 (Reserved) : Disabled
** PM Events **	
VGA : OFF	ESC : Quit ↑↓ → ← : Select Item
LPT & COM : LPT/COM	F1 : Help PU/PD/+/- : Modify
HDD & FDD : ON	F5 : Old Values (Shift) F2 : Color
DMA/master : OFF	F6 : Load BIOS Defaults
Primary INTR : ON	F7 : Load Setup Defaults
IRQ 3 (COM 2) : Primary	
IRQ 4 (COM 1) : Primary	

2. Use the arrow keys to move between items and to select values. Modify the selected fields using the PgUp/PgDn/+/- keys.

A short description of selected screen items follows:

Power Management	Options are as follows:
User Define –	Let's you define the HDD and system power down times.
Disabled –	Disables the Green PC Features.
Min Saving –	Doze timer = 1 Hour Suspend timer = 1 Hour HDD Power Down = 15 Min
Max Saving –	Doze timer = 10 Sec Suspend timer = 10 Sec HDD Power Down = 1 Min

PM Control by APM	Choose Yes (default) or No . APM stands for Advanced Power Management. To use APM, you must run "power.exe" under DOS v6.0 or later version.
Video Off Option	<p>Susp, Stby→off: Video off when the system runs into Suspend or Standby mode.</p> <p>All Modes→off: Video off in all modes.</p> <p>Always On: Video never off.</p> <p>Suspend→off: Video off when system runs into the suspend mode.</p>
Video Off Method	Choose V/H Sync+Blank (default), Blank screen , or DPMS for the selected PM mode.
Conserve Mode	Use the default setting.
HDD Power Down	When the set time has elapsed, the BIOS sends a command to the HDD to power down, which turns off the motor. Time is adjustable from 1 to 15 minutes. The default setting is Disabled. Some older model HDDs may not support this advanced function.
Doze Mode	When the set time has elapsed, the BIOS sends a command to the system to enter doze mode (system clock drops to 33MHz). Time is adjustable from 10 seconds to 1 Hour.
Suspend Mode	The default is Disabled. Only an SL-Enhanced (or SMI) CPU can enter this mode. Time is adjustable from 10 seconds to 1 Hour. Under Suspend mode, the CPU stops completely (no instructions are executed.)
VGA	Choose Off (default) or On to disable or enable the power management.

LPT & COM	Choose LPT/COM (default) or LPT (COM) to enable the power management timer. Choose NONE to disable the power management timer.
HDD & FDD	Choose On (default) to enable the power management timer, or Off to disable the power management timer.
DMA/master	Choose Off (default) or On . If you choose the system “Off”, will not monitor the signal of DMA/master; and when you choose “On”, the system will not have SMI signal until the master is finished while the master is working.
Primary INTR	When On (default) is chosen, you can choose any IRQ #.
IRQ#	When set at “Primary” the processor will power down only after the BIOS detects a “no IRQ activity” during the time specified by the Suspend time. If set at “Secondary event” the system will distinguish whether an interrupt accesses and I/O address or not. If it does, the system enters the standby mode. If not, the system enters the dreaming mode; that is the system goes back full-on status but leaves the monitor blank. For instance, if the system connects to a LAN and receives an interrupt from its file server, the system will enter the dreaming mode to execute the corresponding calling routine.

3. After you have finished with the Power Management Setup, press the <ESC> key to return to the Main Menu.

PNP/PCI Configuration Setup

This option sets the mainboard's PCI Slots. Run this option as follows:

1. Choose "PNP/PCI CONFIGURATION SETUP" from the Main Menu and the following screen appears. (The screen below shows default settings.)

ROM PCI/ISA BIOS PNP/PCI CONFIGURATION AWARD SOFTWARE, INC.	
Resources Controlled By : Manual Reset Configuration Data : Disabled	PCI IRQ Activated By : Level PCI IDE IRQ Map To : PCI-AUTO Primary IDE INT# : A Secondary IDE INT# : B
IRQ-3 assigned to : Legacy ISA* IRQ-4 assigned to : Legacy ISA* IRQ-5 assigned to : PCI/ISA PnP* IRQ-7 assigned to : PCI/ISA PnP* IRQ-9 assigned to : PCI/ISA PnP* IRQ-10 assigned to : PCI/ISA PnP* IRQ-11 assigned to : PCI/ISA PnP* IRQ-12 assigned to : PCI/ISA PnP* IRQ-14 assigned to : PCI/ISA PnP* IRQ-15 assigned to : PCI/ISA PnP* DMA-0 assigned to : PCI/ISA PnP* DMA-1 assigned to : PCI/ISA PnP* DMA-3 assigned to : PCI/ISA PnP* DMA-5 assigned to : PCI/ISA PnP* DMA-6 assigned to : PCI/ISA PnP* DMA-7 assigned to : PCI/ISA PnP*	ESC : Quit ↑↓→←: Select Item F1 : Help PU/PD/+/- : Modify F5 : Old Values (Shift)F2 : Color F6 : Load BIOS Defaults F7 : Load Setup Defaults

*: These items will disappear when Resource Controlled. is Auto.

2. Use the arrow keys to move between items and select values. Modify selected fields using the PgUp/PgDn/+/- keys.

A short description of screen items follows:

Resources Controlled By	Manual – BIOS doesn't manage PCI/ISA PnP card (i.e., IRQ) automatically.
	Auto – BIOS auto manage PCI and ISA PnP card (recommended).
Reset Configuration Data	Disabled – Retain PnP configuration data in BIOS.
	Enabled – Reset PnP configuration data in BIOS.

- IRQX and DMA assigned to** Choose **PCI/ISA PnP** or **Legacy ISA**. If the first item is set to Manual, you could choose IRQX and DMA assigned to PCI/ISA PnP card or ISA card.
- PCI IRQ Activated By** Choose **Edge** or **Level**. Most PCI trigger signals are Level. This setting must match the PCI card.
- PCI IDE IRQ Map To** Select **PCI-AUTO**, **ISA**, or **assign a PCI SLOT number** (depending on which slot the PCI IDE is inserted). The default setting is PCI-AUTO. If PCI-AUTO does not work, then assign an individual PCI SLOT number.
- Primary IDE INT#** Choose INTA#, INTB#, INTC#, or INTD#. The default setting is INTA#.
- Secondary IDE INT#** Choose INTA#, INTB#, INTC#, or INTD#. The default setting is INTB#.
3. After you have finished with the PCI Slot Configuration, press the <ESC> key and follow the screen instructions to save or disregard your settings.

Load Setup Defaults

This item loads the system values you have previously saved. Choose this item and the following message appears:

“Load SETUP Defaults (Y/N)? N”

To use the SETUP defaults, change the prompt to “Y” and press <Enter>. This item is recommended if you need to reset the system setup.

Note: The SETUP Defaults are optimized for the most stabilized performance.

Load BIOS Defaults

Choose this item and the following message appears:

“Load BIOS Defaults (Y/N)?N”

To use the BIOS defaults, change the prompt to “Y” and press <Enter>.

Note: BIOS DEFAULTS values are adjusted for high performance. If you run into any problems after loading BIOS DEFAULTS, please load the SETUP DEFAULTS for the stable performance.

IDE Primary Master PIO/ IDE Primary Slave PIO/ IDE Secondary Master PIO/ IDE Secondary Slave PIO	Choose Auto (default) or mode 0~4 . Mode 0 is the slowest speed, and HDD mode 4 is the fastest speed. For better performance and stability, we suggest you use the Auto setting to set the HDD control timing.
IDE Secondary Master UDMA IDE Secondary Slave UDMA	Choose Auto (default) or Disabled . When Auto is selected, it supports Ultra DMA Mode.
Onboard FDC Controller	Enabled – Use the on-board floppy controller (default). Disabled – Turn off the on-board floppy controller.
Onboard UART 1/ Onboard UART 2	Choose serial port 1 & 2's I/O address. Do not set port 1 & 2 to the same value except for Disabled. COM 1/3F8H COM3/3E8H COM 2/2F8H COM4/2E8H (default)
Onboard UART 2 Mode	Standard – (default) supports a serial infrared IrDA. HPSIR – supports HP serial infrared interface format ASKIR – supports a Sharp serial interface format.
IR Duplex Mode	Use the default setting (Half). This function shows up only when either HPSIR or ASKIR is chosen in the previous function (Onboard UART 2 Mode).
Onboard Parallel Port	Choose the printer I/O address: 378H/IRQ7 (default), 3BCH/IRQ7, 278H/IRQ5

Parallel Port Mode	Choose ECP + EPP (default), Normal or EPP , ECP mode. The mode depends on your external device that connects to this port.
ECP Mode Use DMA	Choose DMA3 (default) or DMA1 . This setting only works when the Onboard Printer Mode is set at the ECP mode.
Parallel Port EPP Type	Choose EPP specification Ver. 1.7 or 1.9 (default).

Supervisor Password

Based on the setting you made in the “Security Option” of the “BIOS FEATURES SETUP”, this Main Menu item lets you configure the system so that a password is required every time the system boots or an attempt is made to enter the Setup program. Change the password as follows:

1. Choose “SUPERVISOR PASSWORD” in the Main Menu and press <Enter>. The following message appears:

“Enter Password:”

2. Enter a password and press <Enter>. (If you do not wish to use the password function, you can just press <Enter> and a “Password disabled” message appears.)
3. After you enter your password, the following message appears prompting you to confirm the new password:

“Confirm Password:”

4. Re-enter your password and then Press <ESC> to exit to the Main Menu.

Important: *If you forget or lose the password, the only way to access the system is to set jumper JP5 to clear the CMOS RAM. All setup information is lost and you must run the BIOS setup program again.*

User Password

Based on the setting you made in the “Security Option” of the “BIOS FEATURES SETUP”, this Main Menu item lets you configure the system so that a password is required every time the system boots or an attempt is made to enter the Setup program. Change the password as follows:

1. Choose “USER PASSWORD” in the Main Menu and press <Enter>. The following message appears:

“Enter Password:”

2. Enter a password and press <Enter>. (If you do not wish to use the password function, you can just press <Enter> and a “Password disabled” message appears.)
3. After you enter your password, the following message appears prompting you to confirm the new password:

“Confirm Password:”

4. Re-enter your password and then Press <ESC> to exit to the Main Menu.
5. You are not allowed to change any setting in “CMOS SETUP UTILITY” except change user’s password.

Important: If you forget or lose the password, the only way to access the system is to set jumper JP5 to clear the CMOS RAM. All setup information is lost and you must run the BIOS setup program again.

IDE HDD Auto Detection

This Main Menu item automatically detects the hard disk type and configures the STANDARD CMOS SETUP accordingly.

Note: This function is only valid for IDE hard disks.

ROM PCI/ISA BIOS
CMOS SETUP UTILITY
AWARD SOFTWARE, INC.

HARD DISKS	TYPE	SIZE	CYLS	HEAD	PRECOMP	LANDZ	SECTOR	MODE
Primary Master	: None	0	0	0	0	0	0	----
Primary Slave	: None	0	0	0	0	0	0	----
Secondary Master	: None	0	0	0	0	0	0	----
Secondary Slave	: None	0	0	0	0	0	0	----

Do you accept this drive C (Y/N)? N

ESC : Skip

Quick Installation Guide

This Quick Installation Guide leaflet is designed for those people who are familiar with motherboard settings to set up this new motherboard in order to boot up the system. Refer back to the proper chapters if you have run in to any problems.

Motherboard Layout

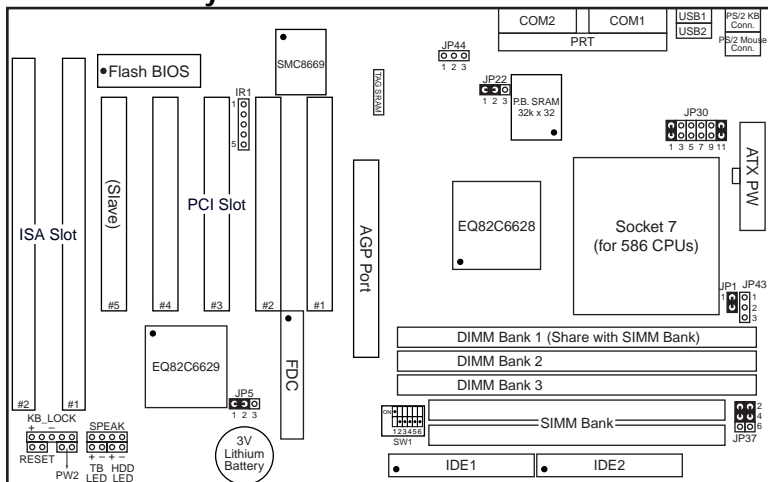

CPU Voltage and Frequency Jumper Settings

Voltage Settings: JP30

CPU Frequency Settings: SW1

	1-2	3-4	5-6	7-8	9-10	11-12	Multiplier	1	2	3	Frequency	4	5	6
Single 3.52V	close	open	open	open	open	close	1.5x/3.5x	off	off	off	50MHz	on	on	off
Single 3.3V	close	open	open	open	close	open	2.0x	on	off	off	60MHz	off	off	off
Dual 3.2V	close	open	open	close	open	open	2.5x	on	on	off	66MHz	on	off	off
Dual 2.9V	close	open	close	open	open	open	3.0x	off	on	off	75MHz	off	on	off
Dual 2.8V	close	open	open	open	open	close	4.0x	on	off	on				
							4.5x	on	on	on				
							5.0x	off	on	on				

Memory Configuration

	SIMM Bank	DIMM Bank			
	Bank 0	DIMM 1	DIMM 2	DIMM 3	
RAM Type	FPM/EDO	FPM/EDO/SDRAM	FPM/EDO/SDRAM	FPM/EDO/SDRAM	
Size (MB)	4/8/16/32/64	4/8/16/32/64/128	4/8/16/32/64/128	4/8/16/32/64/128	

Note: Do not use FPM or EDO SIMM/DIMM if you already use SDRAM. Do not use Bank0 and DIMM1 at the same time.

New item in CHIPSET FEATURES SETUP

New BIOS add a item in “CHIPSET FEATURES SETUP” and it’s “SUSTAINED 3T WRITE” (or “DIRTY BIT”).

Enabled : Set the L2 cache dirty bit to 0.

Disabled : Set the L2 cache dirty bit to 1.

Note : Please refer to page 13 for detail information about the relation between Dirty bit and Cacheable range.