



# Intel<sup>®</sup> Desktop Board D810EMO/MO810E Technical Product Specification



*February 2000*

*Order Number A00653-001*

# Revision History

---

Revision	Revision History	Date
-001	First release of the Intel® Desktop Board D810EMO/MO810E Technical Product Specification	February 2000

This product specification applies to only standard D810EMO/MO810E boards with BIOS identifier MO81010A.86A.

Changes to this specification will be published in the Intel Desktop Board D810EMO/MO810E Specification Update before being incorporated into a revision of this document.

Information in this document is provided in connection with Intel® products. No license, express or implied, by estoppel or otherwise, to any intellectual property rights is granted by this document. Except as provided in Intel's Terms and Conditions of Sale for such products, Intel assumes no liability whatsoever, and Intel disclaims any express or implied warranty, relating to sale and/or use of Intel products including liability or warranties relating to fitness for a particular purpose, merchantability, or infringement of any patent, copyright or other intellectual property right. Intel products are not intended for use in medical, life saving, or life sustaining applications.

Intel may make changes to specifications and product descriptions at any time, without notice.

The D810EMO/MO810E board may contain design defects or errors known as errata that may cause the product to deviate from published specifications. Current characterized errata are available on request.

Contact your local Intel sales office or your distributor to obtain the latest specifications before placing your product order.

Copies of documents which have an ordering number and are referenced in this document, or other Intel literature, may be obtained from:

Intel Corporation  
P.O. Box 5937  
Denver, CO 80217-9808

or call in North America 1-800-548-4725, Europe 44-0-1793-431-155, France 44-0-1793-421-777,  
Germany 44-0-1793-421-333, other Countries 708-296-9333.

† All other brands and names are the property of their respective owners.

Copyright © 2000, Intel Corporation. All rights reserved.

# Preface

---

This Technical Product Specification (TPS) specifies the board layout, components, connectors, power and environmental requirements, and the BIOS for the D810EMO/MO810E desktop board. It describes the standard product and available manufacturing options.

The D810EMO desktop board is known in some documentation and sales collateral as the MO810E. Both names refer to the same product.

## Intended Audience

The TPS is intended to provide detailed, technical information about the board and its components to the vendors, system integrators, and other engineers and technicians who need this level of information. It is specifically *not* intended for general audiences.

## What This Document Contains

Chapter	Description
1	A description of the hardware used on this board
2	A map of the resources of the board
3	The features supported by the BIOS Setup program
4	The contents of the BIOS Setup program's menus and submenus
5	A description of the BIOS error messages, beep codes, and POST codes

## Typographical Conventions

This section contains information about the conventions used in this specification. Not all of these symbols and abbreviations appear in all specifications of this type.

## Notes, Cautions, and Warnings

### ⇒ NOTE

*Notes call attention to important information.*



### CAUTION

*Cautions are included to help you avoid damaging hardware or losing data.*



### WARNING

*Warnings indicate conditions that, if not observed, can cause personal injury.*

## Other Common Notation

#	Used after a signal name to identify an active-low signal (such as USBP0#)
(NxnX)	When used in the description of a component, N indicates component type, xn are the relative coordinates of its location on the board, and X is the instance of the particular part at that general location. For example, J5J1 is a connector, located at 5J. It is the first connector in the 5J area.
KB	Kilobyte (1024 bytes)
Kbit	Kilobit (1024 bits)
MB	Megabyte (1,048,576 bytes)
Mbit	Megabit (1,048,576 bits)
GB	Gigabyte (1,073,741,824 bytes)
xxh	An address or data value ending with a lowercase h indicates a hexadecimal value.
x.x V	Volts. Voltages are DC unless otherwise specified.
†	This symbol is used to indicate third-party brands and names that are the property of their respective owners.

# Contents

---

## 1 Product Description

1.1	Overview .....	10
1.1.1	Feature Summary .....	10
1.1.2	Board Layout.....	11
1.1.3	Block Diagram.....	12
1.2	Online Support.....	13
1.3	Design Specifications .....	13
1.4	Processor .....	16
1.5	System Memory.....	17
1.6	Intel® 810E Chipset .....	18
1.6.1	Direct AGP .....	19
1.6.2	USB.....	19
1.6.3	IDE Support.....	20
1.6.4	Real-Time Clock, CMOS SRAM, and Battery.....	20
1.7	I/O Controller .....	21
1.8	Serial Debug Port .....	21
1.9	Graphics Subsystem .....	22
1.10	Audio Subsystem.....	23
1.10.1	Creative Sound Blaster AudioPCI 128V .....	23
1.10.2	Creative ES1373D Digital Audio Controller.....	23
1.10.3	Crystal Semiconductor CS4297A Analog Codec.....	23
1.10.4	Audio Connectors.....	24
1.11	Hardware Monitor Component.....	24
1.12	LAN Subsystem.....	25
1.12.1	Intel® 82559 PCI LAN Controller .....	25
1.12.2	LAN Subsystem Software.....	26
1.12.3	RJ-45 LAN Connector LEDs.....	26
1.13	Power Management Features.....	27
1.13.1	ACPI.....	27
1.13.2	Hardware Support .....	29

## 2 Technical Reference

2.1	Introduction.....	33
2.2	Memory Map .....	33
2.3	I/O Map .....	34
2.4	DMA Channels .....	35
2.5	PCI Configuration Space Map .....	36
2.6	Interrupts .....	36
2.7	PCI Interrupt Routing Map .....	37
2.8	Connectors .....	38
2.8.1	Back Panel I/O Connectors .....	39
2.8.2	Internal I/O Connectors .....	41
2.8.3	External I/O Connectors .....	46

2.9	Jumper Block.....	49
2.10	Mechanical Considerations.....	51
2.10.1	FlexATX Form Factor .....	51
2.10.2	I/O Shield .....	52
2.11	Electrical Considerations .....	53
2.11.1	Add-in Board Considerations.....	53
2.11.2	Power Consumption .....	53
2.11.3	Power Supply Considerations.....	54
2.11.4	Fan Power Requirements.....	54
2.12	Thermal Considerations.....	55
2.13	Reliability .....	56
2.14	Environmental.....	57
2.15	Regulatory Compliance .....	58
2.15.1	Safety Regulations .....	58
2.15.2	EMC Regulations .....	58
2.15.3	Certification Markings.....	59
<b>3</b>	<b>Overview of BIOS Features</b>	
3.1	Introduction.....	61
3.2	BIOS Flash Memory Organization .....	62
3.3	Resource Configuration .....	62
3.3.1	PCI Autoconfiguration .....	62
3.3.2	PCI IDE Support.....	63
3.4	System Management BIOS (SMBIOS) .....	64
3.5	BIOS Upgrades .....	65
3.5.1	Language Support.....	65
3.5.2	Custom Splash Screen.....	65
3.6	Recovering BIOS Data .....	66
3.7	Boot Options.....	67
3.7.1	CD-ROM and Network Boot .....	67
3.7.2	Booting Without Attached Devices .....	67
3.8	USB Legacy Support .....	68
3.9	BIOS Security Features .....	69
<b>4</b>	<b>BIOS Setup Program</b>	
4.1	Introduction.....	71
4.2	Maintenance Menu .....	72
4.2.1	Extended Configuration Submenu.....	73
4.3	Main Menu.....	74
4.4	Advanced Menu.....	75
4.4.1	Boot Configuration Submenu .....	76
4.4.2	Peripheral Configuration Submenu.....	77
4.4.3	IDE Configuration Submenu.....	78
4.4.4	Event Log Configuration.....	81
4.4.5	Video Configuration.....	82

4.5	Security Menu.....	83
4.6	Power Menu .....	84
4.7	Boot Menu .....	85
4.8	Exit Menu .....	87

## 5 Error Messages and Beep Codes

5.1	BIOS Error Messages.....	89
5.2	Port 80h POST Codes .....	91
5.3	Bus Initialization Checkpoints .....	95
5.4	Speaker .....	96
5.5	BIOS Beep Codes .....	97

## Figures

1.	Board Components.....	11
2.	Block Diagram .....	12
3.	Intel 810E Chipset Block Diagram .....	18
4.	Back Panel I/O Connectors .....	39
5.	Internal I/O Connectors .....	41
6.	External I/O Connectors .....	46
7.	Location of the Jumper Block .....	49
8.	Board Dimensions .....	51
9.	I/O Shield Dimensions .....	52
10.	High Temperature Zones.....	55
11.	Memory Map of the Flash Memory Device .....	62

## Tables

1.	Feature Summary.....	10
2.	Specifications .....	13
3.	Processors Supported by the Board .....	16
4.	System Memory Configuration.....	17
5.	Supported Graphics Refresh Rates .....	22
6.	LAN Connector LED States .....	26
7.	Effects of Pressing the Power Switch .....	27
8.	Power States and Targeted System Power .....	28
9.	Wake Up Devices and Events .....	29
10.	Fan Connector Descriptions .....	30
11.	System Memory Map.....	33
12.	I/O Map .....	34
13.	DMA Channels .....	35
14.	PCI Configuration Space Map .....	36
15.	Interrupts .....	36
16.	PCI Interrupt Routing Map.....	37
17.	USB Connectors.....	40
18.	VGA Port Connector.....	40
19.	LAN Connector .....	40
20.	Audio Line Out Connector .....	40

21.	Mic In Connector .....	40
22.	Chassis Fan Connector (J2J1) .....	42
23.	Processor Fan Connector (J7J1) .....	42
24.	Primary IDE Connector (J7E1) .....	42
25.	Slimline IDE Connector (J8E1) .....	43
26.	Serial Debug Port Connector (J7C1) .....	43
27.	Power Connector (J8B1) .....	44
28.	PCI Bus Connector (J4B1) .....	45
29.	ATAPI CD-ROM Connector (J2D1) .....	45
30.	USB Port Connector (J7A1).....	47
31.	Front Panel Connector (J8C1).....	47
32.	States for a Single-colored Power LED.....	48
33.	States for a Dual-colored Power LED .....	48
34.	BIOS Setup Configuration Jumper Settings (J8F1).....	50
35.	Power Usage .....	53
36.	Chassis Fan (J3A2) DC Power Requirements .....	54
37.	Thermal Considerations for Components .....	56
38.	Board Environmental Specifications .....	57
39.	Safety Regulations .....	58
40.	EMC Regulations.....	58
41.	Supervisor and User Password Functions .....	69
42.	BIOS Setup Program Menu Functions.....	71
43.	BIOS Setup Program Function Keys .....	72
44.	Maintenance Menu .....	72
45.	Extended Configuration Submenu .....	73
46.	Main Menu.....	74
47.	Advanced Menu.....	75
48.	Boot Configuration Submenu.....	76
49.	Peripheral Configuration Submenu .....	77
50.	IDE Configuration Submenu .....	78
51.	Primary/Secondary IDE Master/Slave Submenus.....	79
52.	Event Log Configuration Submenu .....	81
53.	Video Configuration Submenu .....	82
54.	Security Menu.....	83
55.	Power Menu .....	84
56.	Boot Menu .....	85
57.	Exit Menu .....	87
58.	BIOS Error Messages.....	89
59.	Uncompressed INIT Code Checkpoints .....	91
60.	Boot Block Recovery Code Checkpoints .....	91
61.	Runtime Code Uncompressed in F000 Shadow RAM .....	92
62.	Bus Initialization Checkpoints .....	95
63.	Upper Nibble High Byte Functions.....	95
64.	Lower Nibble High Byte Functions.....	96
65.	Beep Codes.....	97

# 1 Product Description

---

## What This Chapter Contains

1.1	Overview .....	10
1.2	Online Support.....	13
1.3	Design Specifications .....	13
1.4	Processor .....	16
1.5	System Memory.....	17
1.6	Intel® 810E Chipset .....	18
1.7	I/O Controller .....	21
1.8	Serial Debug Port .....	21
1.9	Graphics Subsystem .....	22
1.10	Audio Subsystem.....	23
1.11	Hardware Monitor Component.....	24
1.12	LAN Subsystem.....	25
1.13	Power Management Features.....	27

## 1.1 Overview

### 1.1.1 Feature Summary

Table 1 summarizes the D810EMO/MO810E board's major features.

**Table 1. Feature Summary**

<b>Form Factor</b>	FlexATX (9.0 inches by 7.5 inches)
<b>Processor</b>	Support for either an Intel® Pentium® III processor in a Flip Chip Pin Grid Array (FC-PGA) package or an Intel® Celeron™ processor in an FCPGA package or a PPGA package
<b>Memory</b>	<ul style="list-style-type: none"> <li>• One 168-pin dual inline memory module (DIMM) socket</li> <li>• Supports up to 256 MB of 100 MHz non-ECC synchronous DRAM (SDRAM)</li> <li>• Support for serial presence detect (SPD) and non-SPD DIMMs</li> </ul>
<b>Chipset</b>	Intel® 810E chipset, consisting of: <ul style="list-style-type: none"> <li>• Intel® 82810E DC-133 Graphics/Memory Controller Hub (GMCH)</li> <li>• Intel® 82801AA I/O Controller Hub (ICH)</li> <li>• Intel® 82802AB 4 Mbit Firmware Hub (FWH)</li> </ul>
<b>Direct AGP Video</b>	<ul style="list-style-type: none"> <li>• Intel 82810E DC-133 GMCH</li> <li>• 4 MB of display cache</li> <li>• VGA port connector on back panel</li> </ul>
<b>Audio</b>	Audio Codec '97 (AC '97) compatible audio subsystem, consisting of the following: <ul style="list-style-type: none"> <li>• Creative Sound Blaster† AudioPCI 128V digital audio controller (ES1373D)</li> <li>• Crystal Semiconductor CS4297A analog codec</li> </ul>
<b>I/O Controller</b>	SMSC LPC47M102 SIO low pin count (LPC) interface I/O controller
<b>Peripheral Interfaces</b>	<ul style="list-style-type: none"> <li>• Up to four universal serial bus (USB) ports</li> <li>• Two IDE interfaces with Ultra DMA support</li> </ul>
<b>Serial Debug Port</b>	One 9-pin stake-pin serial debug port connector
<b>Expansion capabilities</b>	One PCI bus connector at PCI slot 5 location
<b>Management Level 4 Support</b>	<ul style="list-style-type: none"> <li>• Intel® 82559 local area network (LAN) controller</li> <li>• Hardware monitor</li> </ul>
<b>Instantly Available PC</b>	<ul style="list-style-type: none"> <li>• Support for <i>PCI Local Bus Specification</i>, Revision 2.2</li> <li>• Suspend-to-RAM support</li> <li>• Wake on USB ports</li> </ul>
<b>BIOS</b>	<ul style="list-style-type: none"> <li>• Intel®/AMI BIOS stored in an Intel 82802AB 4 Mbit firmware hub (FWH)</li> <li>• Support for Advanced Configuration and Power Interface (ACPI), Plug and Play, and SMBIOS</li> </ul>

#### ⇒ NOTE

*The D810EMO/MO810E board is designed to support only USB-aware operating systems.*

**For information about**

The board's compliance level with ACPI, Plug and Play, and SMBIOS

**Refer to**

Table 2, page 13

## 1.1.2 Board Layout

Figure 1 shows the location of the major components on the board.

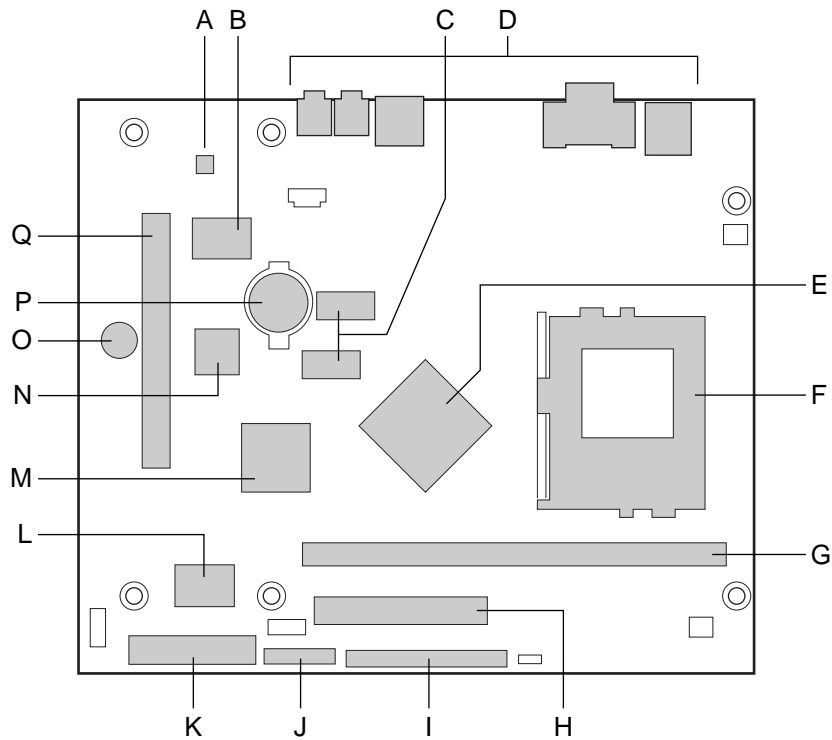

OM08923

A	Crystal Semiconductor CS4297A codec	J	Front panel connector
B	Creative ES1373D digital audio controller	K	Power connector
C	4 MB display cache	L	SMSC LPC47M102 I/O controller
D	Back panel I/O connectors	M	Intel 82801AA ICH
E	Intel 82810E DC-133 GMCH	N	Intel 82559 PCI LAN Controller
F	Processor socket	O	Speaker
G	DIMM socket	P	Battery
H	Primary IDE connector	Q	PCI bus connector
I	Slimline Secondary IDE connector		

**Figure 1. Board Components**

### 1.1.3 Block Diagram

Figure 2 is a block diagram of the major functional areas of the board.

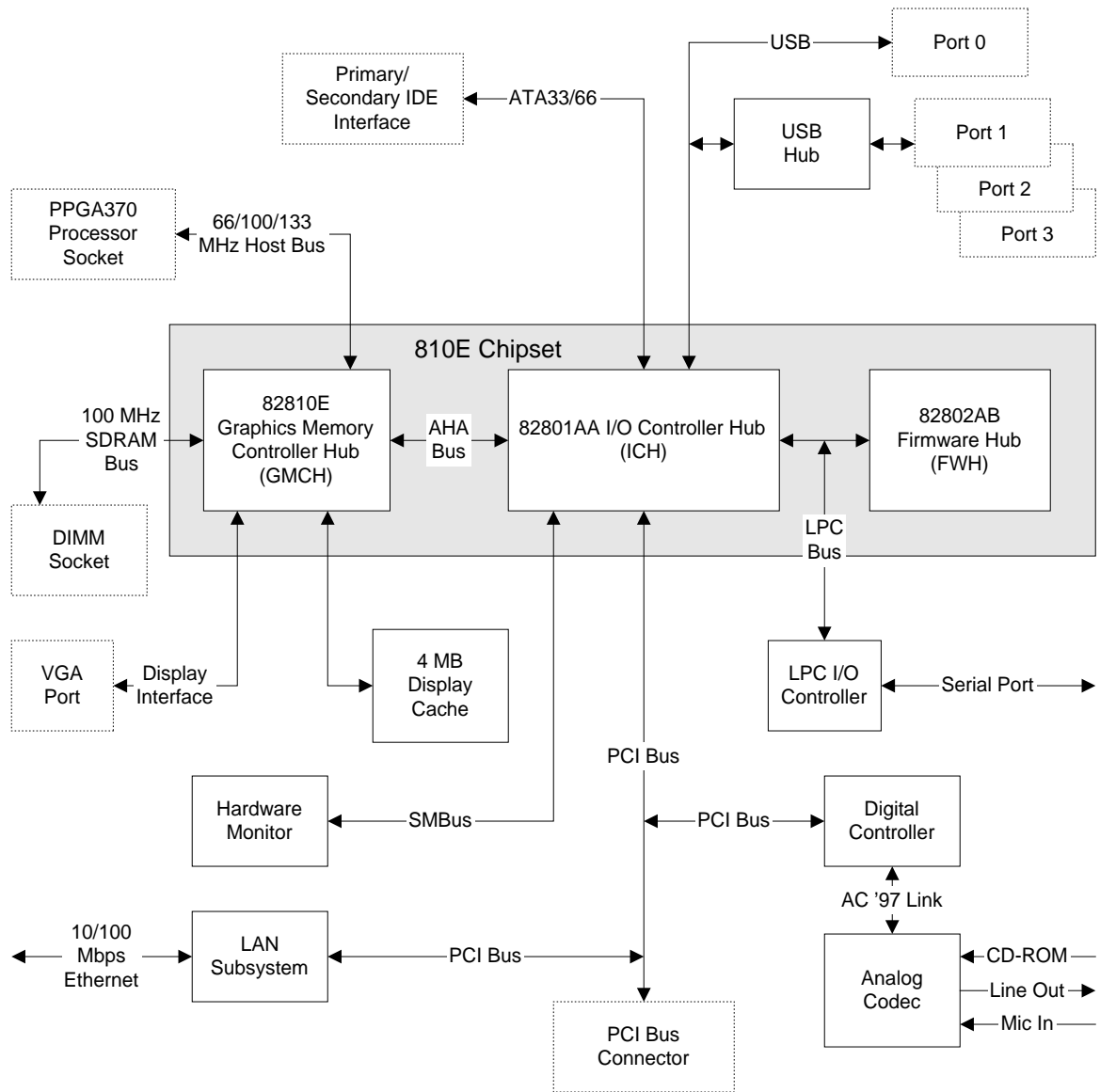

OM09093

Figure 2. Block Diagram

## 1.2 Online Support

Find information about Intel® desktop boards under “Product Info” or “Customer Support” at these World Wide Web sites:

<http://www.intel.com/design/motherbd>

<http://support.intel.com/support/motherboards/desktop>

## 1.3 Design Specifications

Table 2 lists the specifications applicable to the D810EMO/MO810E board.

**Table 2. Specifications**

Reference Name	Specification Title	Version, Revision Date, and Ownership	This specification is available at:
AC '97	<i>Audio Codec '97</i>	Version 2.1, May 1998, Intel Corporation.	<a href="ftp://download.intel.com/pc-supp/platform/ac97">ftp://download.intel.com/pc-supp/platform/ac97</a>
ACPI	<i>Advanced Configuration and Power Interface Specification (2X only)</i>	Version 1.0, July 1, 1998, Intel Corporation, Microsoft Corporation, and Toshiba Corporation.	<a href="http://www.teleport.com/~acpi/">http://www.teleport.com/~acpi/</a>
AGP	<i>Accelerated Graphics Port Interface Specification</i>	Version 2.0, May 4, 1998, Intel Corporation.	the Accelerated Graphics Implementers Forum at: <a href="http://www.agpforum.org/">http://www.agpforum.org/</a>
AMI BIOS	<i>American Megatrends BIOS Specification</i>	AMIBIOS 99, June 1999, American Megatrends, Inc.	<a href="http://www.ami.com/amibios/bios.platforms.desktop.html">http://www.ami.com/amibios/bios.platforms.desktop.html</a>
ATA-3	<i>Information Technology - AT Attachment-3 Interface, X3T10/2008D</i>	Version 6	ATA Anonymous FTP Site: <a href="ftp://fission.dt.wdc.com">ftp://fission.dt.wdc.com</a>
ATAPI	<i>Information Technology AT Attachment with Packet Interface Extensions T13/1153D</i>	Version 18 August 13, 1998, Contact: T13 Chair, Seagate Technology	T13 Anonymous FTP Site: <a href="ftp://fission.dt.wdc.com/x3t13/project/d1153r18.pdf">ftp://fission.dt.wdc.com/x3t13/project/d1153r18.pdf</a>
ATX	<i>ATX Specification</i>	Version 2.01, February 1997, Intel Corporation.	<a href="http://download.intel.com/design/motherbd/atx.htm">http://download.intel.com/design/motherbd/atx.htm</a>
EI Torito	Bootable CD-ROM format specification	Version 1.0, January 25, 1995, Phoenix Technologies Ltd., and IBM Corporation.	the Phoenix Technologies web site at: <a href="http://www.ptltd.com/techs/specs.html">http://www.ptltd.com/techs/specs.html</a>
FlexATX	FlexATX Addendum to the microATX Specification	Version 1.0	<a href="http://www.teleport.com/~ffsupprt/spec/FlexATXaddn1_01.pdf">http://www.teleport.com/~ffsupprt/spec/FlexATXaddn1_01.pdf</a>

continued

**Table 2. Specifications** (continued)

Reference Name	Specification Title	Version, Revision Date, and Ownership	This specification is available at:
IrDA†	Serial Infrared Physical Layer Link Specification	Version 1.1, October 17, 1995 Infrared Data Association Phone: (510) 943-6546 Fax: (510) 943-5600	E-mail: <a href="mailto:irda@netcom.com">irda@netcom.com</a>
LPC	<i>Low Pin Count Interface Specification</i>	Version 1.0, September 29, 1997, Intel Corporation.	<a href="http://www.intel.com/design/chipsets/industry/lpc.htm">http://www.intel.com/design/chipsets/industry/lpc.htm</a>
MicroATX	<i>microATX Motherboard Interface Specification</i>	Version 1.0, December 1997 Intel Corporation	<a href="http://www.teleport.com/~ffsupprt/spec/microatxspecs.htm">http://www.teleport.com/~ffsupprt/spec/microatxspecs.htm</a>
	SFX Power Supply Design Guide	Version 1.1, February 1998 Intel Corporation	<a href="http://www.teleport.com/~ffsupprt/spec/microatxspecs.htm">http://www.teleport.com/~ffsupprt/spec/microatxspecs.htm</a>
PCI	<i>PCI Local Bus Specification</i>	Version 2.2, December 18, 1998, PCI Special Interest Group.	<a href="http://www.pcisig.com/">http://www.pcisig.com/</a>
	<i>PCI Bus Power Management Interface Specification</i>	Version 1.1, December 18, 1998, PCI Special Interest Group.	<a href="http://www.pcisig.com/">http://www.pcisig.com/</a>
Plug and Play	<i>Plug and Play BIOS Specification</i>	Version 1.0a, May 5, 1994, Compaq Computer Corp., Phoenix Technologies Ltd., and Intel Corporation.	<a href="ftp://download.intel.com/ial/wfm/bio10a.pdf">ftp://download.intel.com/ial/wfm/bio10a.pdf</a>
SDRAM DIMMs (64-and 72-bit)	<i>PC SDRAM Unbuffered DIMM Specification</i>	Revision 1.0, February 1998, Intel Corporation.	<a href="http://www.intel.com/design/chipsets/memory/sdram.htm#S1">http://www.intel.com/design/chipsets/memory/sdram.htm#S1</a>
	<i>PC Serial Presence Detect (SPD) Specification</i>	Revision 1.2A, December 1997, Intel Corporation	<a href="http://www.intel.com/design/chipsets/memory/sdram.htm#S1">http://www.intel.com/design/chipsets/memory/sdram.htm#S1</a>
SMBIOS	<i>System Management BIOS</i>	Version 2.3, August 12, 1998, Award Software International Inc., Dell Computer Corporation, Hewlett-Packard Company, Intel Corporation, International Business Machines Corporation, Phoenix Technologies Limited, American Megatrends Inc., and SystemSoft Corporation.	<a href="http://developer.intel.com/ial/wfm/design/smbios">http://developer.intel.com/ial/wfm/design/smbios</a>

continued

**Table 2. Specifications** (continued)

<b>Reference Name</b>	<b>Specification Title</b>	<b>Version, Revision Date, and Ownership</b>	<b>This specification is available at:</b>
UHCI	<i>Universal Host Controller Interface Design Guide</i>	Version 1.1, March 1996, Intel Corporation.	This guide is available at: <a href="http://www.usb.org/developers">http://www.usb.org/developers</a>
USB	<i>Universal Serial Bus Specification</i>	Version 1.1, September 23, 1998, Compaq Computer Corporation, Intel Corporation, Microsoft Corporation, and NEC.	<a href="http://www.usb.org/developers/docs.html">http://www.usb.org/developers/docs.html</a>
WfM	<i>Wired for Management Baseline</i>	Version 2.0, December 18, 1998, Intel Corporation	<a href="http://developer.intel.com/ial/WfM/wfmspecs.htm">http://developer.intel.com/ial/WfM/wfmspecs.htm</a>

## 1.4 Processor



### CAUTION

*The board supports processors that draw a maximum of 22 amps. Using a processor that draws more than 22 amps can damage the processor, the board, and the power supply. See the processor's data sheet for current usage requirements.*

The board supports the processors listed in Table 3. The host bus frequency is automatically selected.

**Table 3. Processors Supported by the Board**

Processor Type	Processor Speed	Host Bus Frequency	L2 Cache Size
Pentium III processor	600EB MHz	133 MHz	256 KB
	600E MHz	100 MHz	256 KB
	550E MHz	100 MHz	256 KB
	500E MHz	100 MHz	256 KB
Celeron processor	533 MHz	66 MHz	128 KB
	500 MHz	66 MHz	128 KB
	466 MHz	66 MHz	128 KB
	433 MHz	66 MHz	128 KB
	400 MHz	66 MHz	128 KB
	366 MHz	66 MHz	128 KB

All supported onboard memory can be cached, up to the cachability limit of the processor.

For information about	Refer to
Processor support for the D810EMO/MO810E board	<a href="http://support.intel.com/support/motherboards/desktop">http://support.intel.com/support/motherboards/desktop</a>
Processor data sheets	<a href="http://www.intel.com/design/litcentr">http://www.intel.com/design/litcentr</a>

## 1.5 System Memory



### CAUTION

To be fully compliant with all applicable Intel® SDRAM memory specifications, the board should be populated with DIMMs that support the Serial Presence Detect (SPD) data structure. If your memory modules do not support SPD, you will see a notification to this effect on the screen at power up. The BIOS will attempt to configure the memory controller for normal operation; however, DIMMs may not function at the determined frequency.



### CAUTION

Because the main system memory is also used as video memory, the board requires a 100 MHz SDRAM DIMM even though the host bus frequency is 66 MHz. It is highly recommended that an SPD DIMM be used, since this allows the BIOS to read the SPD data and program the chipset to accurately configure memory settings for optimum performance. If non-SPD memory is installed, the BIOS will attempt to correctly configure the memory settings, but performance and reliability may be impacted.

The board has one DIMM socket. The minimum memory size is 32 MB and the maximum memory size is 256 MB. The BIOS automatically detects memory type, size, and frequency.

The board supports the following memory features:

- 3.3 V, 168-pin DIMM with gold-plated contacts
- 100 MHz SDRAM
- Serial Presence Detect (SPD) or non-SPD memory (BIOS recovery requires an SPD DIMM)
- Non-ECC (64-bit) memory
- Unbuffered single- or double-sided DIMM

The board is designed to support the DIMM configurations listed in Table 4 below.

**Table 4. System Memory Configuration**

DIMM Size	Non-ECC Configuration
32 MB	4 Mbit x 64
64 MB	8 Mbit x 64
128 MB	16 Mbit x 64
256 MB (Note)	32 Mbit x 64

Note: A 256 MB DIMM used with this board must be built with 128 Mbit device technology.

For information about	Refer to
The <i>PC Serial Presence Detect Specification</i>	Table 2, page 13
Obtaining copies of PC SDRAM specifications	<a href="http://www.intel.com/design/pcisets/memory">http://www.intel.com/design/pcisets/memory</a>

## 1.6 Intel® 810E Chipset

The Intel 810E chipset consists of the following devices:

- 82810E DC-133 Graphics Memory Controller Hub (GMCH) with accelerated hub architecture (AHA) bus
- 82801AA I/O Controller Hub (ICH) with AHA bus
- 82802AB Firmware Hub (FWH)

The chipset provides the host, memory, display, and I/O interfaces shown in Figure 3.

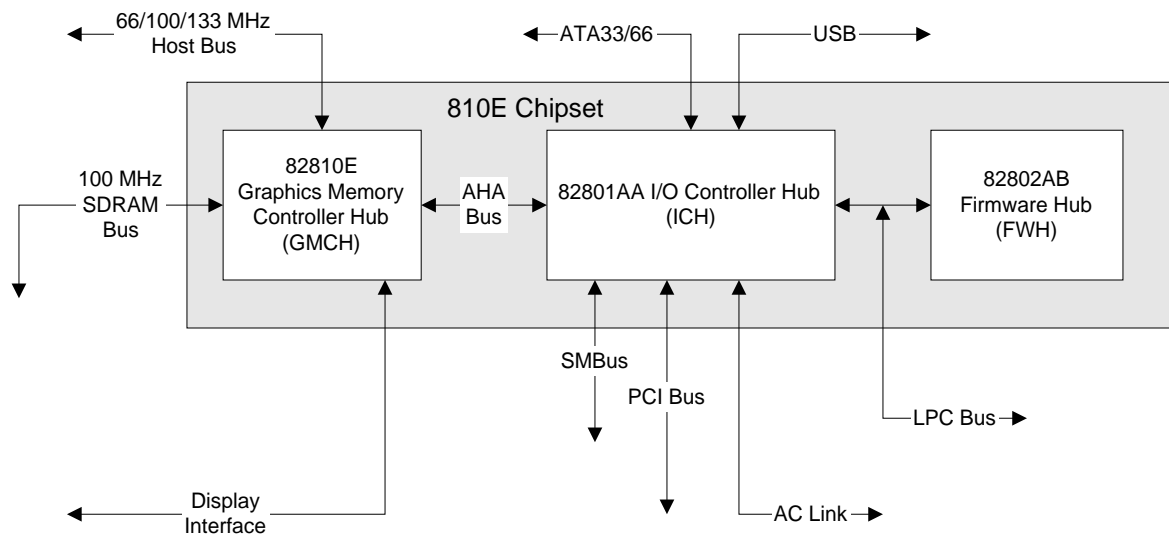

**Figure 3. Intel 810E Chipset Block Diagram**

For information about	Refer to
The Intel 810E chipset	<a href="http://developer.intel.com">http://developer.intel.com</a>
The resources used by the chipset	Chapter 2
The chipset's compliance with ACPI and AC '97	Table 2, page 13

## 1.6.1 Direct AGP

Direct (integrated) AGP is a high-performance bus (independent of the PCI bus) for graphics-intensive applications, such as 3-D applications. AGP overcomes certain limitations of the PCI bus related to handling large amount of graphics data with the following features:

- Pipelined memory read and write operations that hide memory access latency
- Demultiplexing of address and data on the bus for nearly 100 percent bus efficiency

For information about	Refer to
The location of the VGA port connector	Figure 4, page 39
Obtaining the <i>Accelerated Graphics Port Interface Specification</i>	Table 2, page 13

## 1.6.2 USB

The board supports up to four USB ports; one USB peripheral can be connected to each port. For more than four USB devices, an external hub can be connected to any of the ports. Two USB ports are implemented with stacked back panel connectors. The other two ports can be routed from the connector at location J7A1 via a cable to the front panel. The board fully supports UHCI and uses UHCI-compatible software drivers. USB features include:

- Support for self-identifying peripherals that can be connected or disconnected while the computer is running
- Automatic mapping of function to driver and configuration
- Support for isochronous and asynchronous transfer types over the same set of wires
- Support for up to 127 physical devices
- Guaranteed bandwidth and low latencies appropriate for telephony, audio, and other applications
- Error-handling and fault-recovery mechanisms built into the protocol

### ⇒ NOTE

*Computer systems that have an unshielded cable attached to a USB port may not meet FCC Class B requirements, even if no device or a low-speed USB device is attached to the cable. Use shielded cable that meets the requirements for full-speed devices.*

For information about	Refer to
The location of the USB connectors on the back panel	Figure 4, page 39
The signal names of the USB connectors	Table 17, page 40
The location of the USB port connector for the front panel	Figure 6, page 46
The signal names for the USB port connector for the front panel	Table 30, page 47
The USB and UHCI specifications	Table 2, page 13

### 1.6.3 IDE Support

The board has two independent bus-mastering IDE interfaces. These interfaces support:

- ATAPI devices (such as CD-ROM drives)
- ATA devices using the transfer modes listed in Table 51 on page 79

The BIOS supports logical block addressing (LBA) and extended cylinder head sector (ECHS) translation modes. The drive reports the transfer rate and translation mode to the BIOS.

The board supports laser servo (LS-120) diskette technology through its IDE interfaces. The LS-120 drive can be configured as a boot device by setting the BIOS Setup program's Boot menu to one of the following:

- ARMD-FDD (ATAPI removable media device – floppy disk drive)
- ARMD-HDD (ATAPI removable media device – hard disk drive)

The board has two IDE interface connectors. The primary IDE connector is a standard 40-pin IDE interface. The secondary IDE connector is a 50-pin Slimline IDE connector, intended for use with devices such as 2.5-inch hard disk drives and mobile CD-ROM drives. The Slimline IDE connector has the standard IDE interface pins but also includes audio and power signals.

For information about	Refer to
The location of the IDE connectors	Figure 5, page 41
The signal names of the primary IDE connector	Table 24, page 42
The signal names of the Slimline secondary IDE connector	Table 25, page 43
BIOS Setup program's Boot menu	Table 56, page 85

### 1.6.4 Real-Time Clock, CMOS SRAM, and Battery

The real-time clock is compatible with DS1287 and MC146818 components. The clock provides a time-of-day clock and a multicentury calendar with alarm features and century rollover. The real-time clock supports 256 bytes of battery-backed CMOS SRAM in two banks that are reserved for BIOS use.

A coin-cell battery powers the real-time clock and CMOS memory. When the computer is not plugged into a wall socket, the battery has an estimated life of three years. When the computer is plugged in, the 3.3 V standby current from the power supply extends the life of the battery. The clock is accurate to  $\pm 13$  minutes/year at 25 °C with 3.3 VSB applied.

The time, date, and CMOS values can be specified in the BIOS Setup program. The CMOS values can be returned to their defaults by using the BIOS Setup program.

#### ⇒ NOTE

*If the battery and AC power fail, standard defaults, not custom defaults, will be loaded into CMOS RAM at power on.*

**⇒ NOTE**

*The recommended method of accessing the date in systems with Intel desktop boards is indirectly from the Real-Time Clock (RTC) via the BIOS. The BIOS on Intel desktop boards contains a century checking and maintenance feature. This feature checks the two least significant digits of the year stored in the RTC during each BIOS request (INT 1Ah) to read the date and, if less than 80 (i.e., 1980 is the first year supported by the PC), updates the century byte to 20. This feature enables operating systems and applications using the BIOS date/time services to reliably manipulate the year as a four-digit value.*

For information about	Refer to
Proper date access in systems with Intel desktop boards	<a href="http://support.intel.com/support/year2000/">http://support.intel.com/support/year2000/</a>

## 1.7 I/O Controller

The SMSC LPC47M102 I/O controller provides the following features:

- Low pin count (LPC) interface
- One serial port
- Infrared (IrDA) interface
- Intelligent power management, including a programmable wake up event interface
- Fan control:
  - One pulse width modulation (PWM) fan speed control output
  - One fan tachometer input

The BIOS Setup program provides configuration options for the I/O controller.

For information about	Refer to
SMSC LPC47M102 I/O controller	<a href="http://www.smsc.com">http://www.smsc.com</a>
The IrDA interface	Section 2.8.3, page 46

## 1.8 Serial Debug Port

The board has one 9-pin serial debug port connector. The serial debug port's NS16C550-compatible UART supports data transfers at rates of up to 115.2 kbits/sec with BIOS support. The serial debug port can be assigned as COM1 (3F8h), COM2 (2F8h), COM3 (3E8h), or COM4 (2E8h).

For information about	Refer to
The location of the serial debug port connector	Figure 5, page 41
The signal names of the serial debug port connector	Table 26, page 43

## 1.9 Graphics Subsystem

The Intel 82810E DC-133 GMCH graphics memory controller hub component provides the following graphics support features:

- Integrated 2-D and 3-D graphics engines
- Integrated hardware motion compression engine
- Integrated 230 MHz DAC

Table 5 lists the refresh rates supported by graphics subsystem.

**Table 5. Supported Graphics Refresh Rates**

Resolution	Color Palette	Available Refresh Frequencies (Hz)
640 x 480	16 colors	60, 70, 72, 75, 85
	256 colors	60, 70, 72, 75, 85
	64 K colors	60, 70, 72, 75, 85
	16 M colors	60, 70, 72, 75, 85
720 x 480	256 colors	75, 85
	64 K colors	75, 85
	16 M colors	75, 85
720 x 576	256 colors	60, 75, 85
	64 K colors	60, 75, 85
	16 M colors	60, 75, 85
800 x 600	256 colors	60, 70, 72, 75, 85
	64 K colors	60, 70, 72, 75, 85
	16 M colors	60, 70, 72, 75, 85
1024 x 768	256 colors	60, 70, 72, 75, 85
	64 K colors	60, 70, 72, 75, 85
	16 M colors	60, 70, 72, 75, 85
1152 x 864	256 colors	60, 70, 72, 75, 85
	64 K colors	60, 70, 72, 75, 85
	16 M colors	60, 70, 72, 75, 85
1280 x 1024	256 colors	60, 70, 72, 75, 85
	64 K colors	60, 70, 72, 75, 85
	16 M colors	60, 70, 75, 85
1600 x 1200	256 colors	60, 70, 72, 75, 85

### For information about

Obtaining graphics software and utilities

### Refer to

<http://support.intel.com/support/motherboards/desktop>

## 1.10 Audio Subsystem

The Audio Codec '97 (AC '97) compatible audio subsystem includes these features:

- Split digital/analog architecture for improved signal-to-noise ratio ( $\geq 85$  dB) measured at line out, from any analog input, including line in, and CD-ROM
- 3-D stereo enhancement
- Power management support for ACPI 1.0a

The audio subsystem consists of these devices:

- Creative Sound Blaster AudioPCI 128V
- Crystal Semiconductor CS4297A stereo audio codec
- Audio connectors

For information about	Refer to
Obtaining audio software and utilities	Section 1.2, page 13

### 1.10.1 Creative Sound Blaster AudioPCI 128V

The Creative Sound Blaster AudioPCI 128V features:

- Creative ES1373D digital audio controller
- Interfaces to the PCI bus as a Plug and Play device
- 100% DOS legacy compatible
- Access to main memory (through the PCI bus) for wavetable synthesis support – does not require a separate wavetable ROM device
- Conforms to the PC 98 and PC 99 design guides

For information about	Refer to
Creative Sound Blaster AudioPCI 128V	<a href="http://www.soundblaster.com">http://www.soundblaster.com</a>

### 1.10.2 Creative ES1373D Digital Audio Controller

The Creative ES1373D digital audio controller's features include:

- PCI 2.1 compliant
- PCI bus master for PCI audio
- 128-voice wavetable synthesizer
- Aureal A3D<sup>†</sup> API, Sound Blaster Pro<sup>†</sup>, Roland MPU-401 MIDI, joystick compatible
- Ensoniq 3D positional audio and Microsoft DirectSound<sup>†</sup> 3D support

### 1.10.3 Crystal Semiconductor CS4297A Analog Codec

The Crystal Semiconductor CS4297A is a fully AC '97 compliant codec. The codec's features include:

- 18-bit stereo full-duplex operation
- Up to 48 kHz sampling rate
- Connects to ES1373D digital controller using a five-wire digital interface

## 1.10.4 Audio Connectors

The audio connectors include the following:

- Line out (back panel)
- Mic in (back panel)
- ATAPI CD-ROM (connects an internal ATAPI CD-ROM drive to the audio mixer)

<b>For information about</b>	<b>Refer to</b>
The back panel audio connectors	Section 2.8.1, page 39
The location of the ATAPI CD-ROM connector	Figure 5, page 41
The signal names of the ATAPI CD-ROM connector	Table 29, page 45

## 1.11 Hardware Monitor Component

The hardware monitor component provides low-cost instrumentation capabilities. The features of the component include:

- Internal ambient temperature sensing
- Remote thermal diode sensing for direct monitoring of processor temperature
- Power supply monitoring (+12, +5, +3.3, +2.5, VCCP) to detect levels above or below acceptable values
- SMBus interface
- The hardware monitor component enables the board to be compatible with the Wired for Management (WfM) specification.

<b>For information about</b>	<b>Refer to</b>
The board's compatibility with the WfM specification	Table 2, page 13

## 1.12 LAN Subsystem

The Intel 82559 Fast Ethernet Wired for Management (WfM) PCI LAN subsystem provides both 10Base-T and 100Base-TX connectivity. Features include:

- 32-bit, 33 MHz direct bus mastering on the PCI bus
- 10Base-T and 100Base-TX capability using a single RJ-45 connector with connection and activity status LEDs
- IEEE 802.3u Auto-Negotiation for the fastest available connection
- Jumperless configuration; the LAN subsystem is completely software-configurable

For information about	Refer to
The WfM specification	Table 2, page 13

### 1.12.1 Intel® 82559 PCI LAN Controller

The Intel 82559 PCI LAN controller's features include:

- CSMA/CD Protocol Engine
- PCI bus interface
- DMA engine for movement of commands, status, and network data across the PCI bus
- Integrated physical layer interface, including:
  - Complete functionality necessary for the 10Base-T and 100Base-TX network interfaces; when in 10 Mbit/sec mode, the interface drives the cable directly
  - A complete set of Media Independent Interface (MII) management registers for control and status reporting
  - IEEE 802.3u Auto-Negotiation for automatically establishing the best operating mode when connected to other 10Base-T or 100Base-TX devices, whether half- or full-duplex capable
- Integrated power management features, including support for wake on network event (from an ACPI S3 state using the PCI bus PME# signal)

For information about	Refer to
The LAN subsystem's PCI specification compliance	Table 2, page 13

### 1.12.2 LAN Subsystem Software

The Intel 82559 Fast Ethernet WfM PCI LAN software and drivers are available from Intel's World Wide Web site.

For information about	Refer to
Obtaining LAN software and drivers	Section 1.2, page 13

### 1.12.3 RJ-45 LAN Connector LEDs

Two LEDs are built into the RJ-45 LAN connector. Table 6 describes the LED states when the board is powered up and the LAN subsystem is operating.

**Table 6. LAN Connector LED States**

LED Color	LED State	Condition
Green	Off	10 Mbit/sec data rate is selected.
	On	100 Mbit/sec data rate is selected.
Yellow	Off	LAN link is not established.
	On (steady state)	LAN link is established.
	On (brighter and pulsing)	The computer is communicating with another computer on the LAN.

## 1.13 Power Management Features

Power management is implemented at several levels, including:

- Advanced Configuration and Power Interface (ACPI)
- Hardware support:
  - Power connector
  - Wake on network event
  - Instantly Available technology
  - Wake on Ring
  - Resume on Ring

### 1.13.1 ACPI

If the board is used with an ACPI-aware operating system, the BIOS can provide ACPI support. ACPI gives the operating system direct control over the power management and Plug and Play functions of a computer. The use of ACPI with this board requires the support of an operating system that provides full ACPI functionality. ACPI features include:

- Plug and Play (including bus and device enumeration)
- Power management control of individual devices, add-in boards (some add-in boards may require an ACPI-aware driver), video displays, and hard disk drives
- Methods for achieving less than 30-watt system operation in the Power On Suspend sleeping state, and less than 5-watt system operation in the Suspend to RAM sleeping state
- A Soft-off feature that enables the operating system to power off the computer
- Support for multiple wake up events (see Table 9 on page 29)
- Support for a front panel power and sleep mode switch. Table 7 lists the system states based on how long the power switch is pressed, depending on how ACPI is configured with an ACPI-aware operating system.

**Table 7. Effects of Pressing the Power Switch**

If the system is in this state...	...and the power switch is pressed for	...the system enters this state
Off (ACPI G2/S5 state)	Less than four seconds	Power on
On (ACPI G0 state)	Less than four seconds	Soft off/Suspend
On (ACPI G0 state)	More than four seconds	Fail safe power off
Sleep (ACPI G1 state)	Less than four seconds	Wake up
Sleep (ACPI G1 state)	More than four seconds	Power off

#### For information about

The board's compliance level with ACPI

#### Refer to

Section 1.3, page 13

### 1.13.1.1 System States and Power States

Under ACPI, the operating system directs all system and device power state transitions. The operating system puts devices in and out of low-power states based on user preferences and knowledge of how devices are being used by applications. Devices that are not being used can be turned off. The operating system uses information from applications and user settings to put the system as a whole into a low-power state.

Table 8 lists the power states supported by the board along with the associated system power targets. See the ACPI specification for a complete description of the various system and power states.

**Table 8. Power States and Targeted System Power**

Global States	Sleeping States	CPU States	Device States	Targeted System Power*
G0 – working state	S0 – working	C0 – working	D0 – working state	Full power > 30 W
G1 – sleeping state	S1 – CPU stopped	C1 – stop grant	D1, D2, D3 – device specification specific.	5 W < power < 30 W
G1 – sleeping state	S3 – Suspend-to-RAM. Context saved to RAM.	No power	D3 – no power except for wake up logic.	Power < 5 W **
G2/S5	S5 – Soft off. Context not saved. Cold boot is required.	No power	D3 – no power except for wake up logic.	Power < 5 W **
G3 – mechanical off. AC power is disconnected from the computer.	No power to the system.	No power	D3 – no power for wake up logic, except when provided by battery or external source.	No power to the system so that service can be performed.

\* Total system power is dependent on the system configuration, including add-in boards and peripherals powered by the system chassis' power supply.

\*\* Dependent on the standby power consumption of wake up devices used in the system.

### 1.13.1.2 Wake Up Devices and Events

Table 9 lists the devices or specific events that can wake the computer from specific states.

**Table 9. Wake Up Devices and Events**

These devices/events can wake up the computer...	...from this state
Power switch	S1, S3, S5
RTC alarm	S1, S3, S5
LAN	S1, S3
Modem	S1, S3
USB	S1, S3
PCI bus PME#	S3

### 1.13.1.3 Plug and Play

In addition to power management, ACPI provides controls and information so that the operating system can facilitate Plug and Play device enumeration and configuration. ACPI is used only to enumerate and configure devices that do not have other hardware standards for enumeration and configuration. PCI devices on a desktop board, for example, are not enumerated by ACPI.

## 1.13.2 Hardware Support



### CAUTION

*If Wake on network event and Instantly Available technology features are used, the power supply must be capable of providing adequate +5 V standby current. Failure to provide adequate standby current can damage the power supply. The total amount of standby current required depends on the wake devices supported and manufacturing options. Refer to Section 2.11.3 on page 54 for additional information.*

The board provides several hardware features that support power management, including:

- Power connector
- Wake on network event
- Instantly Available technology
- Wake on Ring
- Resume on Ring

Wake on network event and Instantly Available technology require power from the +5 V standby line. The sections discussing these features describe the incremental standby power requirements for each.

Wake on Ring and Resume on Ring enable telephony devices to access the computer when it is in a power-managed state. The method used depends on the type of telephony device (external or internal) and the power management mode being used (ACPI).

### ⇒ NOTE

*The use of Wake on Ring and Resume on Ring technologies from an ACPI state require the support of an operating system that provides full ACPI functionality.*

### 1.13.2.1 Power Connector

When used with an ATX-compliant power supply that supports remote power on/off, the board can turn off the system power through software control. To enable soft-off control in software, advanced power management must be enabled in the BIOS Setup program and in the operating system. When the system BIOS receives the correct power management command from the operating system, the BIOS turns off power to the computer.

With soft-off enabled, if power to the computer is interrupted by a power outage or a disconnected power cord, when power resumes, the computer returns to the power state it was in before power was interrupted (on or off).

For information about	Refer to
The location of the power connector	Figure 5, page 41
The signal names of the power connector	Table 27, page 44
The ATX specification	Section 1.3, page 13

### 1.13.2.2 Fan Connectors

The board has two fan connectors. The functions of these connectors are described in Table 10.

**Table 10. Fan Connector Descriptions**

Connector	Function
Chassis fan	Provides +12 V DC for a system or chassis fan.
Processor fan	Provides +12 V DC for a processor fan or active fan heatsink.

For information about	Refer to
The location of the fan connectors	Figure 5, page 41
The signal names of the chassis fan connector	Table 22, page 42
The signal names of the processor fan connector	Table 23, page 42

### 1.13.2.3 Wake on Network Event



#### CAUTION

*For Wake on network event, the +5 V standby line for the power supply must be capable of providing adequate +5 V standby current. Failure to provide adequate standby current when implementing Wake on network event can damage the power supply. Refer to Section 2.11.3 on page 54 for additional information.*

Wake on network event enables remote wakeup of the computer through a network. The LAN subsystem, whether onboard or as a PCI bus network adapter, monitors network traffic at the Media Independent Interface. Upon detecting a Magic Packet<sup>†</sup>, the LAN subsystem asserts a wakeup signal that powers up the computer. The board supports Wake on network event through the PCI bus PME# signal.

### 1.13.2.4 Instantly Available Technology



#### CAUTION

*For Instantly Available technology, the +5 V standby line for the power supply must be capable of providing adequate +5 V standby current. Failure to provide adequate standby current when using this feature can damage the power supply. Refer to Section 2.11.3 on page 54 for additional information.*

Instantly Available technology enables the board to enter the ACPI S3 (Suspend-to-RAM) sleep-state. While in the S3 sleep-state, the computer will appear to be off (the power supply is off, the fans are off, and the power LED is amber). When signaled by a wake up device or event, the system quickly returns to its last known wake state. Table 9 on page 29 lists the devices and events that can wake the computer from the S3 state.

The board supports the *PCI Bus Power Management Interface Specification*. For information on the versions of these specifications, see Section 1.3. Add-in boards that also support these specifications can participate in power management and can be used to wake the computer.

### 1.13.2.5 Wake on Ring



#### NOTE

*Wake on Ring requires the use of a modem (external USB or internal PCI) that supports the Wake on Ring feature.*

The operation of Wake on Ring can be summarized as follows:

- Wakes up the computer from the ACPI S5 state
- Requires two calls to access the computer:
  - First call restores the computer
  - Second call enables access (when the appropriate software is loaded)
- Detects incoming calls differently for external as opposed to internal modems:
  - For external USB modems, the USB bus is monitored for the RING\_DETECT signal
  - For internal PCI modems, incoming calls are detected through the PCI bus PME# signal

### 1.13.2.6 Resume on Ring

The operation of Resume on Ring can be summarized as follows:

- Resumes operation from the ACPI S1 state
- Requires only one call to access the computer
- Detects incoming call similarly for external and internal modems



## 2 Technical Reference

---

### What This Chapter Contains

2.1	Introduction.....	33
2.2	Memory Map .....	33
2.3	I/O Map .....	34
2.4	DMA Channels .....	35
2.5	PCI Configuration Space Map .....	36
2.6	Interrupts .....	36
2.7	PCI Interrupt Routing Map .....	37
2.8	Connectors .....	38
2.9	Jumper Block.....	49
2.10	Mechanical Considerations.....	51
2.11	Electrical Considerations .....	53
2.12	Thermal Considerations.....	55
2.13	Reliability .....	56
2.14	Environmental.....	57
2.15	Regulatory Compliance .....	58

### 2.1 Introduction

Sections 2.2 – 2.6 contain several standalone tables. Table 11 describes the system memory map, Table 12 shows the I/O map, Table 13 lists the DMA channels, Table 14 defines the PCI configuration space map, and Table 15 describes the interrupts. The remaining sections in this chapter are introduced by text found with their respective section headings.

### 2.2 Memory Map

**Table 11. System Memory Map**

Address Range (decimal)	Address Range (hex)	Size	Description
1024 K – 262144 K	100000 – FFFFFFFF	255 MB	Extended memory
960 K – 1024 K	F0000 – FFFFFF	64 KB	Runtime BIOS
896 K – 960 K	E0000 – EFFFFF	64 KB	Reserved
800 K – 896 K	C8000 – DFFFFF	96 KB	Available high DOS memory (open to PCI bus)
640 K – 800 K	A0000 – C7FFFF	160 KB	Video memory and BIOS
639 K – 640 K	9FC00 – 9FFFFF	1 KB	Extended BIOS data (movable by memory manager software)
512 K – 639 K	80000 – 9FBFFF	127 KB	Extended conventional memory
0 K – 512 K	00000 – 7FFFFF	512 K	Conventional memory

## 2.3 I/O Map

**Table 12. I/O Map**

Address (hex)	Size	Description
0000 – 000F	16 bytes	DMA Controller
0020 – 0021	2 bytes	Programmable Interrupt Control (PIC)
0040 – 0043	4 bytes	System Timer
0060	1 byte	Keyboard controller byte – reset IRQ
0061	1 byte	System Speaker
0064	1 byte	Keyboard controller, CMD/STAT byte
0070 – 0071	2 bytes	System CMOS / Real Time Clock
0072 – 0073	2 bytes	System CMOS
0080 – 008F	16 bytes	DMA Controller
0092	1 byte	Fast A20 and PIC
00A0 – 00A1	2 bytes	PIC
00C0 – 00DF	32 bytes	DMA
00F0	1 byte	Numeric data processor
0170 – 0177	8 bytes	Secondary IDE channel
01F0 – 01F7	8 bytes	Primary IDE channel
02E8 – 02EF <sup>1</sup>	8 bytes	COM4/video (8514A)
02F8 – 02FF <sup>1</sup>	8 bytes	COM2
0376	1 byte	Secondary IDE channel command port
0377, bits 6:0	7 bits	Secondary IDE channel status port
03B0 – 03BB	12 bytes	Intel 82810E – DC133 Graphics/Memory Controller Hub (GMCH)
03C0 – 03DF	32 byte	Intel 82810E – Graphics/Memory Controller Hub (GMCH)
03E8 – 03EF	8 bytes	COM3
03F6	1 byte	Primary IDE channel command port
03F8 – 03FF	8 bytes	COM1
04D0 – 04D1	2 bytes	Edge/level triggered PIC
0CF8 – 0CFB <sup>2</sup>	4 bytes	PCI configuration address register
0CF9 <sup>3</sup>	1 byte	Turbo and reset control register
0CFC – 0CFF	4 bytes	PCI configuration data register
FFA0 – FFA7	8 bytes	Primary bus master IDE registers
FFA8 – FFAF	8 bytes	Secondary bus master IDE registers

continued

**Table 12. I/O Map (continued)**

Address (hex)	Size	Description
96 contiguous bytes starting on a 128-byte divisible boundary		ICH (ACPI + TCO)
64 contiguous bytes starting on a 64-byte divisible boundary		Onboard resource
32 contiguous bytes starting on a 32-byte divisible boundary		ICH (USB)
16 contiguous bytes starting on a 16-byte divisible boundary		ICH (SMBus)
4096 contiguous bytes starting on a 4096-byte divisible boundary		Intel 82810EAA PCI Bridge
32 contiguous bytes starting on a 32-byte divisible boundary		Intel 82559 LAN Controller
96 contiguous bytes starting on a 128-byte divisible boundary		LPC47M102 PME Status
64 contiguous bytes starting on a 64-byte divisible boundary		Creative ES1373D Digital Audio Controller

Notes:

1. Default, but can be changed to another address range
2. Dword access only
3. Byte access only

⇒ **NOTE**

*Some additional I/O addresses are not available due to ICH addresses aliasing. For information about ICH addressing, refer to Intel web site at:*

<http://developer.intel.com/design/chipsets/datashts/>

## 2.4 DMA Channels

**Table 13. DMA Channels**

DMA Channel Number	Data Width	System Resource
0	8- or 16-bits	Audio
1	8- or 16-bits	Audio
2	8- or 16-bits	Open
3	8- or 16-bits	Open / Audio
4		Reserved - cascade channel
5	16-bits	Open
6	16-bits	Open
7	16-bits	Open

## 2.5 PCI Configuration Space Map

**Table 14. PCI Configuration Space Map**

Bus Number (hex)	Device Number (hex)	Function Number (hex)	Description
00	00	00	Memory controller of Intel 82810E component
00	01	00	Graphics controller of Intel 82810E component
00	1E	00	Link to PCI bridge
00	1F	00	PCI-to-LPC bridge
00	1F	01	IDE controller
00	1F	02	USB controller #1
00	1F	03	SMBus controller
00	1F	04	Reserved
00	1F	05	AC '97 audio controller
00	1F	06	AC '97 modem controller
01	01	00	Intel 82559 PCI LAN controller
01	07	00	PCI Audio Accelerator ES1373D
01	09	00	PCI bus connector

## 2.6 Interrupts

**Table 15. Interrupts**

IRQ	System Resource
NMI	I/O channel check
0	Reserved, interval timer
1	Reserved, keyboard buffer full
2	Reserved, cascade interrupt from slave PIC
3	COM2*
4	COM1*
5	User available
6	User available
7	Audio / User available *
8	Real-time Clock
9	Reserved for ICH system management bus
10	User available
11	User available
12	User available
13	Reserved, math coprocessor
14	Primary IDE (if present, else user available)
15	Secondary IDE (if present, else user available)

\* Default, but can be changed to another IRQ

## 2.7 PCI Interrupt Routing Map

This section describes interrupt sharing and how the interrupt signals are connected between the PCI bus connector and onboard PCI devices. The PCI specification specifies how interrupts can be shared between devices attached to the PCI bus. In most cases, the small amount of latency added by interrupt sharing does not affect the operation or throughput of the devices. In some special cases where maximum performance is needed from a device, a PCI device should not share an interrupt with other PCI devices. Use the following information to avoid sharing an interrupt with a PCI add-in card.

PCI devices are categorized as follows to specify their interrupt grouping:

- **INTA:** By default, all add-in cards that require only one interrupt are in this category. For almost all cards that require more than one interrupt, the first interrupt on the card is also classified as INTA.
- **INTB:** Generally, the second interrupt on add-in cards that require two or more interrupts is classified as INTB. (This is not an absolute requirement.)
- **INTC and INTD:** Generally, a third interrupt on add-in cards is classified as INTC and a fourth interrupt is classified as INTD.

The ICH PCI-to-LPC bridge has four programmable interrupt request (PIRQ) input signals. Any PCI interrupt source (either onboard or from a PCI add-in card) connects to one of these PIRQ signals. Because there are only four signals, some PCI interrupt sources are mechanically tied together on the board and therefore share the same interrupt. Table 16 lists the PIRQ signals and shows how the signals are connected to the PCI bus connectors and to onboard PCI interrupt sources.

**Table 16. PCI Interrupt Routing Map**

PCI Interrupt Source	ICH PIRQ Signal Name			
	PIRQA	PIRQB	PIRQC	PIRQD
AGP Controller	INTA			
ICH Audio Controller			INTC	
ICH USB Controller				INTD
Intel 82559 PCI LAN Controller			INTC	
PCI Bus Connector	INTA	INTB	INTC	INTD

### ⇒ NOTE

*The ICH can connect each PIRQ line internally to one of the IRQ signals (3, 4, 5, 6, 7, 10, 11, 14, and 15). Typically, a device that does not share a PIRQ line will have a unique interrupt. However, in certain interrupt-constrained situations, it is possible for two or more of the PIRQ lines to be connected to the same IRQ signal.*

## 2.8 Connectors



### CAUTION

*Only the back panel I/O connectors of the board have overcurrent protection. The internal board connectors are not overcurrent protected, and should connect only to devices inside the computer chassis, such as fans and internal peripherals. Do not use these connectors for powering devices external to the computer chassis. A fault in the load presented by the external devices could cause damage to the computer, the interconnecting cable, and the external devices themselves.*

This section describes the board's connectors. The connectors can be divided into the following groups:

- Back panel I/O connectors (see page 39)
  - USB (2)
  - VGA
  - LAN
  - Audio line out
  - Mic in
- Internal I/O connectors (see page 41)
  - Fans (2)
  - IDE (2)
  - Serial debug port
  - Power
  - PCI
  - ATAPI CD-ROM
- External I/O connectors (see page 46)
  - USB ports
  - Front panel (Power/Sleep/Message waiting LED, power switch, hard drive activity LED, reset switch, and infrared port)

## 2.8.1 Back Panel I/O Connectors

Figure 4 shows the location of the back panel I/O connectors.

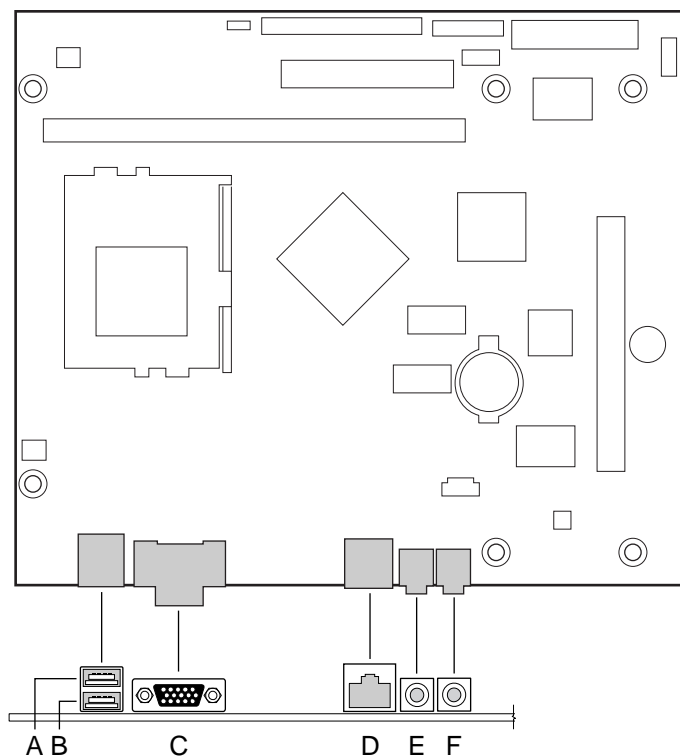

OM08925

Item	Description
A	USB port 0 (see Table 17, page 40)
B	USB port 1 (see Table 17, page 40)
C	VGA port (see Table 18, page 40)
D	LAN (see Table 19, page 40)
E	Audio line out (see Table 20, page 40)
F	Mic in (see Table 21, page 40)

**Figure 4. Back Panel I/O Connectors**

⇒ **NOTE**

*The back panel audio line out connector is designed to power headphones or amplified speakers only. Poor audio quality may occur if passive (non-amplified) speakers are connected to this output.*

**Table 17. USB Connectors**

Pin	Signal Name
1	+5 V (fused)
2	USBP0# / USBP1#
3	USBP0 / USBP1
4	Ground

**Table 18. VGA Port Connector**

Pin	Signal Name	Pin	Signal Name	Pin	Signal Name
1	Red	6	Ground	11	No connect
2	Green	7	Ground	12	MONID1
3	Blue	8	Ground	13	HSYNC
4	No connect	9	Fused VCC	14	VSYNC
5	Ground	10	Ground	15	MONID2

**Table 19. LAN Connector**

Pin	Signal Name
1	TX+
2	TX-
3	RX+
4	Ground
5	Ground
6	RX-
7	Ground
8	Ground

**Table 20. Audio Line Out Connector**

Pin	Signal Name
Tip	Audio left out
Ring	Audio right out
Sleeve	Ground

**Table 21. Mic In Connector**

Pin	Signal Name
Tip	Mono in
Ring	Mic bias voltage
Sleeve	Ground

## 2.8.2 Internal I/O Connectors

Figure 5 shows the location of the internal I/O connectors.

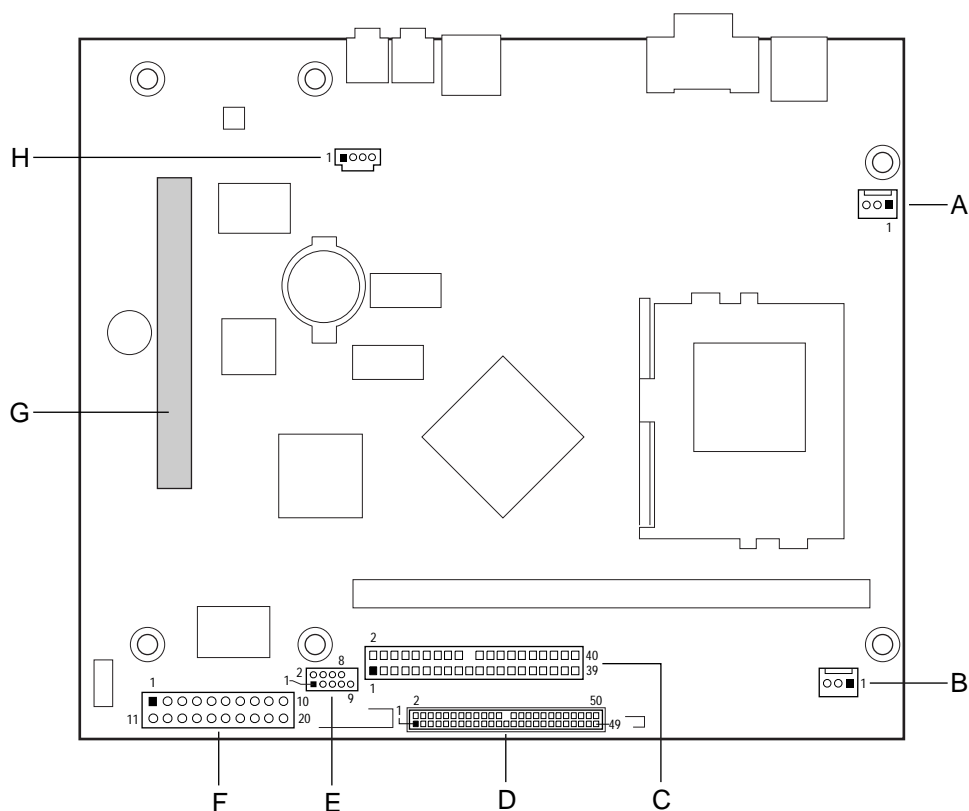

OM08926

Item	Description		Reference Designator
A	Fan 2 (chassis fan)	(see Table 22, page 42)	J2J1
B	Fan 1 (processor fan)	(see Table 23, page 42)	J7J1
C	Primary IDE	(see Table 24, page 42)	J7E1
D	Slimline IDE	(see Table 25, page 43)	J8E1
E	Serial debug port	(see Table 26, page 43)	J7C1
F	Power	(see Table 27, page 44)	J8B1
G	PCI	(see Table 28, page 45)	J4B1
H	ATAPI CD-ROM	(see Table 29, page 45)	J2D1

**Figure 5. Internal I/O Connectors**

For information about	Refer to
The power connector	Section 1.13.2.1, page 30
The functions of the fan connectors	Section 1.13.2.2, page 30

**Table 22. Chassis Fan Connector (J2J1)**

Pin	Signal Name
1	Ground
2	+12 V
3	Ground

**Table 23. Processor Fan Connector (J7J1)**

Pin	Signal Name
1	Ground
2	+12 V
3	FAN_TACH1

**Table 24. Primary IDE Connector (J7E1)**

Pin	Signal Name	Pin	Signal Name
1	Reset IDE	2	Ground
3	Data 7	4	Data 8
5	Data 6	6	Data 9
7	Data 5	8	Data 10
9	Data 4	10	Data 11
11	Data 3	12	Data 12
13	Data 2	14	Data 13
15	Data 1	16	Data 14
17	Data 0	18	Data 15
19	Ground	20	Key
21	DDRQ0	22	Ground
23	I/O Write#	24	Ground
25	I/O Read#	26	Ground
27	IOCHRDY	28	P_ALE (Cable Select pullup)
29	DDACK0#	30	Ground
31	IRQ 14	32	Reserved
33	DAG1 (Address 1)	34	ATA_66 Detect
35	DAG0 (Address 0)	36	DAG2 (Address 2)
37	Chip Select 1P#	38	Chip Select 3P#
39	Activity#	40	Ground

**Table 25. Slimline IDE Connector (J8E1)**

Pin	Signal Name	Pin	Signal Name
1	AUD_LCR_R	2	AUD_RCD_R
3	AUD_CDGND_R	4	AUD_CDGND_R
5	N/C	6	N/C
7	Reset IDE	8	Ground
9	Data 7	10	Data 8
11	Data 6	12	Data 9
13	Data 5	14	Data 10
15	Data 4	16	Data 11
17	Data 3	18	Data 12
19	Data 2	20	Data 13
21	Data 1	22	Data 14
23	Data 0	24	Data 15
25	Ground	26	Key
27	DDRQ1	28	Ground
29	I/O Write#	30	Ground
31	I/O Read#	32	Ground
33	IOCHRDY	34	P_ALE (Cable Select pullup)
35	DDACK1#	36	Ground
37	IRQ 15	38	Reserved
39	DAG1 (Address 1)	40	Reserved
41	DAG0 (Address 0)	42	DAG2 (Address 2)
43	Chip Select 1S#	44	Chip Select 3S#
45	Activity#	46	Ground
47	VCC	48	VCC
49	Ground	50	N/C

**Table 26. Serial Debug Port Connector (J7C1)**

Pin	Signal Name	Pin	Signal Name
1	DCD (Data Carrier Detect)	2	DSR (Data Set Ready)
3	SIN # (Serial Data In)	4	RTS (Request to Send)
5	SOUT # (Serial Data Out)	6	CTS (Clear to Send)
7	DTR (Data Terminal Ready)	8	RI (Ring Indicator)
9	Ground	10	Key

**Table 27. Power Connector (J8B1)**

Pin	Signal Name	Pin	Signal Name
1	+3.3 V	11	+3.3 V
2	+3.3 V	12	-12 V
3	Ground	13	Ground
4	+5 V	14	PS-ON# (power supply remote on/off)
5	Ground	15	Ground
6	+5 V	16	Ground
7	Ground	17	Ground
8	PWRGD (Power Good)	18	PS_FAN_EN
9	+5 VSB	19	+5 V
10	+12 V	20	+5 V

**Table 28. PCI Bus Connector (J4B1)**

Pin	Signal	Pin	Signal	Pin	Signal	Pin	Signal
A1	Ground (TRST#)*	B1	-12 V	A32	AD16	B32	AD17
A2	+12 V	B2	Ground (TCK)*	A33	+3.3 V	B33	C/BE2#
A3	+5 V (TMS)*	B3	Ground	A34	FRAME#	B34	Ground
A4	+5 V (TDI)*	B4	No connect (TDO)*	A35	Ground	B35	IRDY#
A5	+5 V	B5	+5 V	A36	TRDY#	B36	+3.3 V
A6	INTA#	B6	+5 V	A37	Ground	B37	DEVSEL#
A7	INTC#	B7	INTB#	A38	STOP#	B38	Ground
A8	+5 V	B8	INTD#	A39	+3.3 V	B39	LOCK#
A9	Reserved	B9	No connect (PRSNT1#)*	A40	Reserved	B40	PERR#
A10	+5 V (I/O)	B10	Reserved	A41	Reserved	B41	+3.3 V
A11	Reserved	B11	No connect (PRSNT2#)*	A42	Ground	B42	SERR#
A12	Ground	B12	Ground	A43	PAR	B43	+3.3 V
A13	Ground	B13	Ground	A44	AD15	B44	C/BE1#
A14	+3.3 V aux	B14	Reserved	A45	+3.3 V	B45	AD14
A15	RST#	B15	Ground	A46	AD13	B46	Ground
A16	+5 V (I/O)	B16	CLK	A47	AD11	B47	AD12
A17	GNT#	B17	Ground	A48	Ground	B48	AD10
A18	Ground	B18	REQ#	A49	AD09	B49	Ground
A19	PME#	B19	+5 V (I/O)	A50	Key	B50	Key
A20	AD30	B20	AD31	A51	Key	B51	Key
A21	+3.3 V	B21	AD29	A52	C/BE0#	B52	AD08
A22	AD28	B22	Ground	A53	+3.3 V	B53	AD07
A23	AD26	B23	AD27	A54	AD06	B54	+3.3 V
A24	Ground	B24	AD25	A55	AD04	B55	AD05
A25	AD24	B25	+3.3 V	A56	Ground	B56	AD03
A26	IDSEL	B26	C/BE3#	A57	AD02	B57	Ground
A27	+3.3 V	B27	AD23	A58	AD00	B58	AD01
A28	AD22	B28	Ground	A59	+5 V (I/O)	B59	+5 V (I/O)
A29	AD20	B29	AD21	A60	REQ64C#	B60	ACK64C#
A30	Ground	B30	AD19	A61	+5 V	B61	+5 V
A31	AD18	B31	+3.3 V	A62	+5 V	B62	+5 V

\* These signals (in parentheses) are optional in the PCI specification and are not currently implemented.

**Table 29. ATAPI CD-ROM Connector (J2D1)**

Pin	Signal Name
1	Left audio input from CD-ROM
2	CD audio differential ground
3	CD audio differential ground
4	Right audio input from CD-ROM

### 2.8.3 External I/O Connectors

Figure 6 shows the locations of the external I/O connectors.

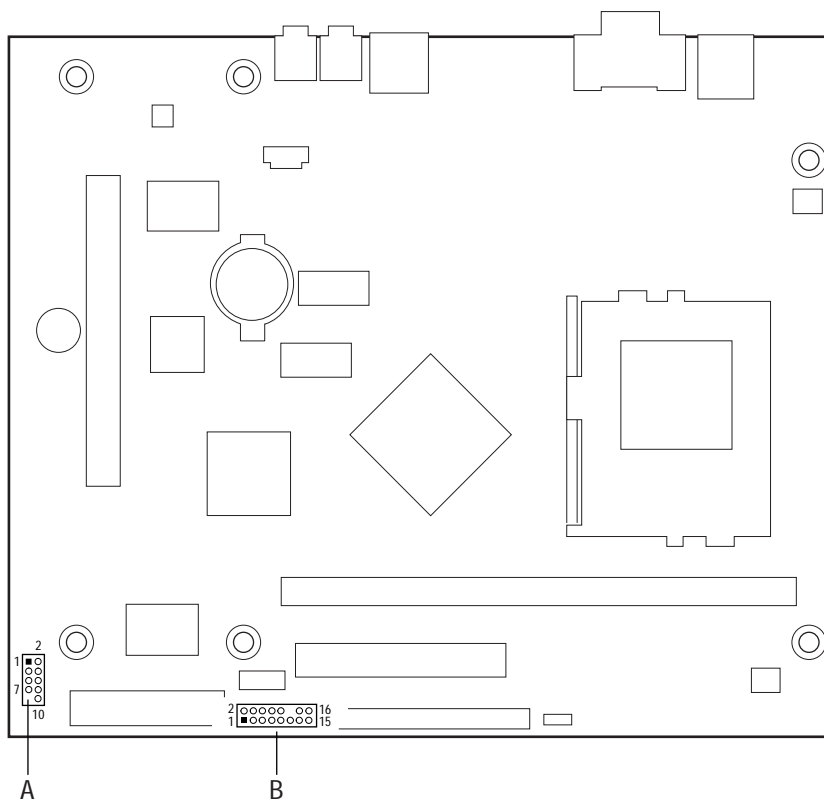

OM08927

Item	Description	Reference Designator
A	USB ports (see Table 30, page 47)	J7A1
B	Front panel (see Table 31, page 47)	J8C1

**Figure 6. External I/O Connectors**

### 2.8.3.1 USB Port Connector

Table 30 lists the signal names of the USB port connector.

**Table 30. USB Port Connector (J7A1)**

Pin	Signal Name	Pin	Signal Name
1	USB_PWR	2	USB_PWR
3	USB_P2RL#	4	USB_P3RL#
5	USB_P2RL	6	USB_P3RL
7	Ground	8	Ground
9	Key (no pin)	10	USB_FP_OC

### 2.8.3.2 Front Panel Connector

Table 31 lists the signal names of the front panel connector.

**Table 31. Front Panel Connector (J8C1)**

Pin	Signal	In/Out	Description	Pin	Signal	In/Out	Description
<b>Hard Drive Activity LED</b>				<b>Power /Sleep / Message Waiting LED</b>			
1	HD_PWR	Out	Hard disk LED pull-up (330 Ω) to +5 V	2	HDR_BLNK_GRN	Out	Front panel green LED
3	HD_LED#	Out	Hard disk active LED	4	HDR_BLNK_YEL	Out	Front panel yellow LED
<b>Reset Switch</b>				<b>Power Switch</b>			
5	GND		Ground	6	SW_ON#	In	Front panel power switch
7	FP_RESET#	In	Front panel Reset button	8	GND		Ground
<b>Infrared Port</b>				<b>Miscellaneous</b>			
9	+5 V	Out	IR Power	10	N/C	In	Not connected
11	IRRX	In	IrDA serial input	12	GND		Ground
13	GND		Ground	14	(Pin removed)		Not connected
15	IRTX	Out	IrDA serial output	16	+5 V	Out	Power

### 2.8.3.2.1 Power / Sleep / Message Waiting LED Connector

Pins 2 and 4 can be connected to a single- or dual-colored LED. Table 32 lists the possible states for a single-colored LED. Table 33 shows the possible states for a dual-colored LED.

**Table 32. States for a Single-colored Power LED**

LED State	Description	ACPI State
Off	Not running	S1, S3, S5
Steady Green	Running	S0
Blinking Green	Running/message waiting	S0

**Table 33. States for a Dual-colored Power LED**

LED State	Description	ACPI State
Off	Power off	S5
Steady Green	Running	S0
Blinking Green	Running/message waiting	S0
Steady Yellow	Sleeping	S1, S3
Blinking Yellow	Sleeping/message waiting	S1, S3

#### ⇒ NOTE

*To use the message waiting function, ACPI must be enabled in the operating system and a message-capturing application must be invoked.*

### 2.8.3.2.2 Power Switch Connector

Pins 6 and 8 can be connected to a front panel power switch. The switch must pull pin 6 to ground for at least 50 ms to signal the power supply to switch on or off. (The time requirement is due to internal debounce circuitry on the board.) At least two seconds must pass before the power supply will recognize another on/off signal.

### 2.8.3.2.3 Hard Drive Activity LED Connector

Pins 1 and 3 can be connected to an LED to provide a visual indicator that data is being read from or written to a hard drive. For the LED to function properly, an IDE drive must be connected to the onboard IDE interface.

### 2.8.3.2.4 Reset Switch Connector

Pins 5 and 7 can be connected to a momentary SPST type switch that is normally open. When the switch is closed, the board resets and runs the POST.

## 2.9 Jumper Block

**⚠ CAUTION**

*Do not move jumpers with the power on. Always turn off the power and unplug the power cord from the computer before changing a jumper setting. Otherwise, damage to the board could occur.*

Figure 7 shows the location of the BIOS Setup jumper block. This 3-pin jumper block determines the BIOS Setup program's mode. Table 34 describes the jumper settings for the three modes: normal, configure, and recovery.

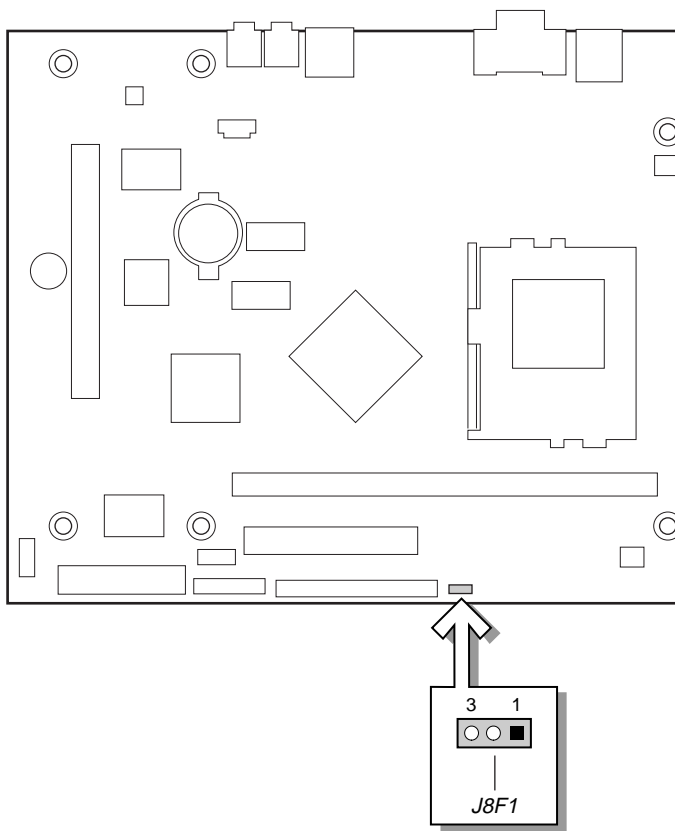

OM08928

**Figure 7. Location of the Jumper Block**

**Table 34. BIOS Setup Configuration Jumper Settings (J8F1)**

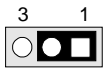
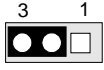
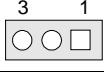
Function/Mode	Jumper Setting	Configuration
Normal	1-2 	The BIOS uses current configuration information and passwords for booting.
Configure	2-3 	After the POST runs, Setup runs automatically. The maintenance menu is displayed.
Recovery	None 	The BIOS attempts to recover the BIOS configuration. Bootable recovery media is required.

For information about	Refer to
How to access the BIOS Setup program	Section 4.1, page 71
The maintenance menu of the BIOS Setup program	Section 4.2, page 72
BIOS recovery	Section 3.6, page 66

## 2.10 Mechanical Considerations

### 2.10.1 FlexATX Form Factor

The board is designed to fit into a FlexATX form-factor chassis. The board can also be installed in a microATX-form-factor chassis. Figure 8 illustrates the mechanical form factor for the board. Dimensions are given in inches [millimeters]. The outer dimensions are 9.0 inches by 7.5 inches (228.6 millimeters by 190.5 millimeters). Location of the I/O connectors and mounting holes are in compliance with the FlexATX addendum of the microATX specification (see Section 1.3).

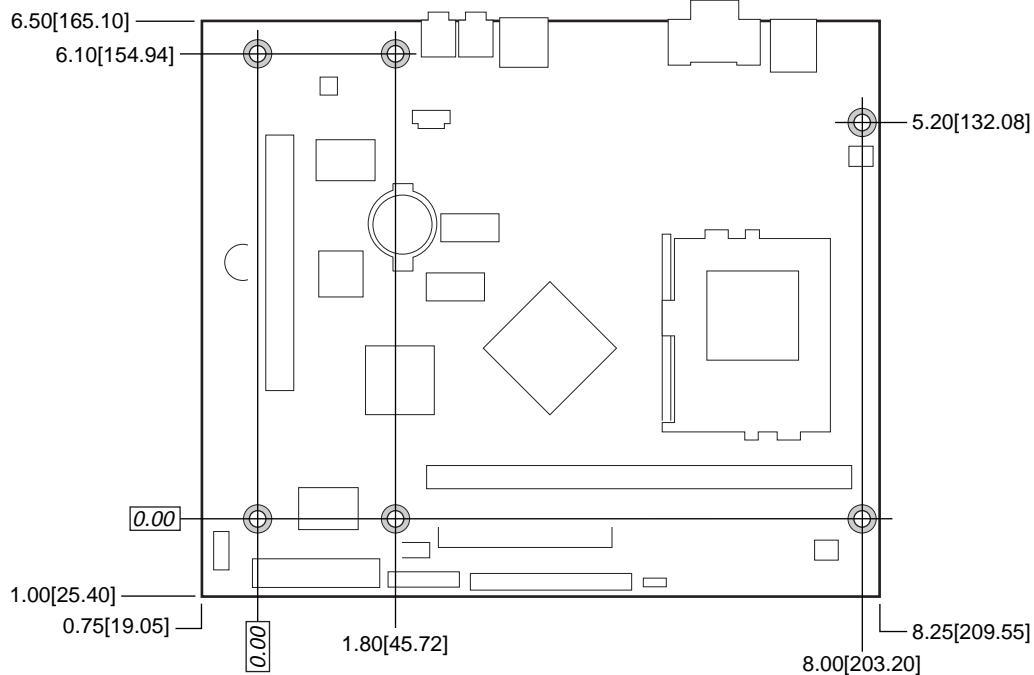

OM08929

Figure 8. Board Dimensions

### 2.10.2 I/O Shield

The back panel I/O shield for the board must meet specific dimension and material requirements. Systems based on this board need the back panel I/O shield to pass certification testing. Figure 9 shows the critical dimensions of the I/O shield. Dimensions are given in inches [millimeters]. For dimensions given to two decimal places, the tolerance is  $\pm 0.02$  inches ( $\pm 5.08$  millimeters). The figure indicates the position of each cutout. Additional design considerations for I/O shields relative to chassis requirements are described in the ATX specification. See Section 1.3 for information about the ATX specification.

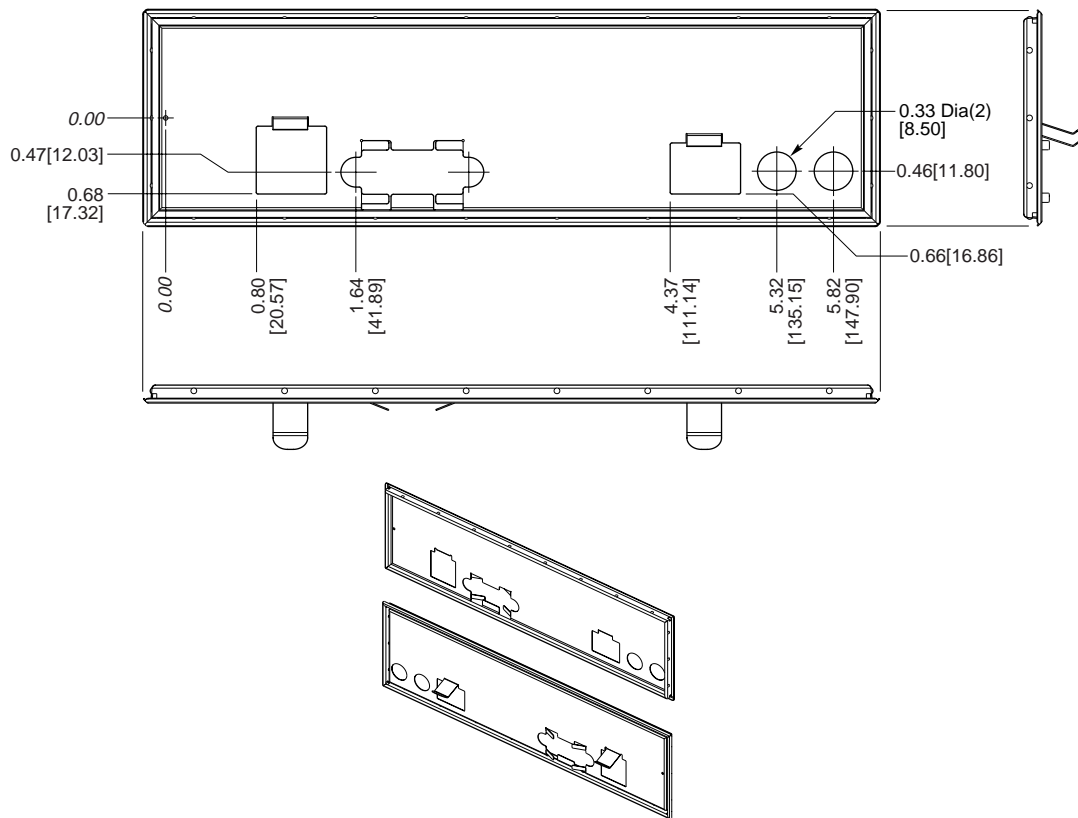

OM08930

Figure 9. I/O Shield Dimensions

## 2.11 Electrical Considerations

### 2.11.1 Add-in Board Considerations

The board is designed to provide 2 A (average) of +5 V current for an add-in board in the PCI slot.

### 2.11.2 Power Consumption

Table 35 lists voltage and current specifications for a computer that contains the board and the following:

- 550E MHz Intel Pentium III processor with a 256 KB cache
- 256 MB SDRAM
- 6.2 GB IDE hard disk drive
- Toshiba Mobile CD-ROM drive

This information is provided only as a guide for calculating approximate power usage with additional resources added.

Values for the Windows<sup>†</sup> 98 desktop mode are measured at 640 x 480 x 256 colors and 60 Hz refresh rate. AC watts are measured with a typical 145 W power supply, nominal input voltage and frequency, with true RMS wattmeter at the line input.

**Table 35. Power Usage**

Mode	AC Watts	DC Amps at:				
		+3.3 V	+5 V	+12 V	-12 V	+5 VSB
Windows 98 ACPI S0	46 W	1.90 A	2.23 A	0.2 A	-0.02 A	0.17 A
Windows 98 ACPI S1	22 W	1.37 A	0.38 A	0.2 A	-0.02 A	0.143 A
Windows 98 ACPI S3	1 W	0.0 A	0.0 A	0.0 A	0.0 A	0.13 A
Windows 98 ACPI S5	1 W	0.0 A	0.0 A	0.0 A	0.0 A	0.11 A

### 2.11.3 Power Supply Considerations

System integrators should refer to the power usage values listed in Table 35 when selecting a power supply for use with this board. The power supply must comply with the following recommendations found in the indicated sections of the ATX form factor specification (see Table 2 on page 13).

- The potential relation between +3.3 VDC and +5 VDC power rails (Section 4.2)
- The current capability of the +5 VSB line (Section 4.2.1.2)
- All timing parameters (Section 4.2.1.3)
- All voltage tolerances (Section 4.2.2)

### 2.11.4 Fan Power Requirements

Table 36 lists the maximum DC voltage and current requirements for the chassis fan when the board is in sleep mode or normal operating mode. Power consumption is independent of the operating system used and other variables.

**Table 36. Chassis Fan (J3A2) DC Power Requirements**

Mode	Voltage	Maximum Current (Amps)
Normal (S0)	+ 12 VDC	250 mA
Sleep (S1)	+ 12 VDC	250 mA
Sleep (S3)	+ 0 VDC	0 mA

For information about	Refer to
The location of the chassis fan connector	Figure 5, page 41
The signal names of the chassis fan connector	Table 23, page 42

## 2.12 Thermal Considerations

**⚠ CAUTION**

An ambient temperature that exceeds the board's maximum operating temperature by 5 °C to 10 °C could cause components to exceed their maximum case temperature and malfunction. For information about the maximum operating temperature, see the environmental specifications in Section 2.14.

Figure 10 shows the localized high-temperature zones.

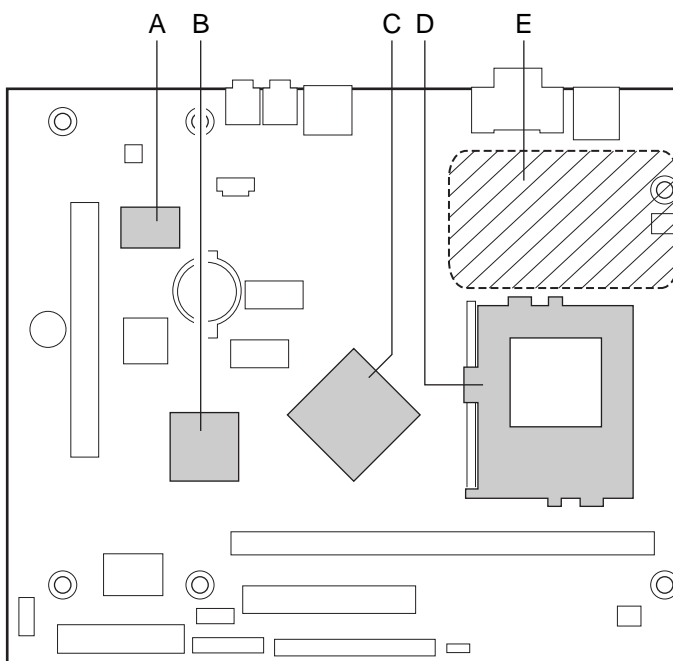

OM08931

- A Creative ES1373D
- B Intel 82801AA ICH
- C Intel 82810E DC-133 GMCH
- D Processor
- E Processor voltage regulator area

**Figure 10. High Temperature Zones**

Table 37 provides maximum component case temperatures for board components that could be sensitive to thermal changes. Case temperatures could be affected by the operating temperature, current load, or operating frequency. Maximum case temperatures are important when considering proper airflow to cool the board.

**Table 37. Thermal Considerations for Components**

Component	Maximum Case Temperature
Intel Celeron Processor	
366 MHz	85 °C
400 MHz	85 °C
433 MHz	85 °C
466 MHz	70 °C
500 MHz	70 °C
533 MHz	70 °C
Intel Pentium III Processor	
500E MHz	85 °C
550E MHz	85 °C
600E MHz	85 °C
600EB MHz	85 °C
Intel 82810E DC-133 GMCH	70 °C
Intel 82801AA ICH	100 °C
Creative ES1373D	70 °C



### CAUTION

*The voltage regulator area can reach a temperature of up to 85 °C in an open chassis. Ensure that there is proper airflow to this area of the board. Failure to do so may result in damage to the voltage regulator circuit. System integrators should ensure that proper airflow is maintained in the voltage regulator circuit (item E in Figure 10). Components in this area could be damaged without adequate airflow.*

## 2.13 Reliability

The mean time between failures (MTBF) prediction is calculated using component and subassembly random failure rates. The calculation is based on the Bellcore Reliability Prediction Procedure, TR-NWT-000332, Issue 4, September 1991. The MTBF prediction is used to estimate repair rates and spare parts requirements.

The Mean Time Between Failures (MTBF) data is calculated from predicted data at 55 °C.

Board MTBF: 330,526 hours

## 2.14 Environmental

Table 38 lists the environmental specifications for the board.

**Table 38. Board Environmental Specifications**

Parameter	Specification		
<b>Temperature</b>			
Non-Operating	-40 °C to +70 °C		
Operating	0 °C to +55 °C		
<b>Shock</b>			
Unpackaged	30 g trapezoidal waveform		
	Velocity change of 170 inches/second		
Packaged	Half sine 2 millisecond		
	Product Weight (pounds)	Free Fall (inches)	Velocity Change (inches/sec)
	<20	36	167
	21-40	30	152
	41-80	24	136
	81-100	18	118
<b>Vibration</b>			
Unpackaged	5 Hz to 20 Hz : 0.01 g <sup>2</sup> Hz sloping up to 0.02 g <sup>2</sup> Hz		
	20 Hz to 500 Hz : 0.02 g <sup>2</sup> Hz (flat)		
Packaged	10 Hz to 40 Hz : 0.015 g <sup>2</sup> Hz (flat)		
	40 Hz to 500 Hz : 0.015 g <sup>2</sup> Hz sloping down to 0.00015 g <sup>2</sup> Hz		

## 2.15 Regulatory Compliance

This section describes the board's compliance with safety and EMC regulations.

### 2.15.1 Safety Regulations

Table 39 lists the safety regulations the board complies with when it is correctly installed in a compatible host system.

**Table 39. Safety Regulations**

Regulation	Title
UL 1950/CSA950, 3 <sup>rd</sup> edition, Dated 07-28-95	Bi-National Standard for Safety of Information Technology Equipment including Electrical Business Equipment. (USA and Canada)
EN 60950, 2 <sup>nd</sup> Edition, 1992 (with Amendments 1, 2, 3, and 4)	The Standard for Safety of Information Technology Equipment including Electrical Business Equipment. (European Community)
IEC 950, 2 <sup>nd</sup> edition, 1991 (with Amendments 1, 2, 3, and 4)	The Standard for Safety of Information Technology Equipment including Electrical Business Equipment. (International)
EMKO-TSE (74-SEC) 207/94	Summary of Nordic deviations to EN 60950. (Norway, Sweden, Denmark, and Finland)

### 2.15.2 EMC Regulations

Table 40 lists the EMC regulations the board complies with when it is correctly installed in a compatible host system.

**Table 40. EMC Regulations**

Regulation	Title
FCC Class B	Title 47 of the Code of Federal Regulations, Parts 2 and 15, Subpart B, pertaining to unintentional radiators. (USA)
CISPR 22, 2 <sup>nd</sup> Edition, 1993 (Class B)	Limits and methods of measurement of Radio Interference Characteristics of Information Technology Equipment. (International)
VCCI Class B (ITE)	Implementation Regulations for Voluntary Control of Radio Interference by Data Processing Equipment and Electronic Office Machines. (Japan)
EN55022 (1994) (Class B)	Limits and methods of measurement of Radio Interference Characteristics of Information Technology Equipment. (Europe)
EN50082-1 (1992)	Generic Immunity Standard; Currently compliance is determined via testing to IEC 801-2, -3, and -4. (Europe)
ICES-003 (1997)	Interference-Causing Equipment Standard, Digital Apparatus, Class B (Including CRC c.1374). (Canada)
AS/NZ 3548	Australian Communications Authority (ACA), Standard for Electromagnetic Compatibility.

### 2.15.3 Certification Markings

This printed circuit assembly has the following product certification markings:

- UL Joint Recognition Mark: Consists of small c followed by a stylized backward UR and followed by a small US (Component side)
- Manufacturer's recognition mark: Consists of a unique UL recognized manufacturer's logo, along with a flammability rating (94V-0) (Solder side)
- UL File Number for desktop boards: E139761 (Component side)
- PB Part Number: Intel bare circuit board part number (Solder side) 746506-003
- Battery "+ Side Up" marking: located on the component side of the board in close proximity to the battery holder
- FCC Logo/Declaration: (Solder side)
- ACA (C-Tick) mark: Consists of a unique letter C, with a tick mark; followed by N-232. Located on the component side of the board and on the shipping container
- CE Mark: (Component side) The CE mark should also be on the shipping container



# 3 Overview of BIOS Features

---

## What This Chapter Contains

- 3.1 Introduction..... 61
- 3.2 BIOS Flash Memory Organization ..... 62
- 3.3 Resource Configuration ..... 62
- 3.4 System Management BIOS (SMBIOS) ..... 64
- 3.5 BIOS Upgrades ..... 65
- 3.6 Recovering BIOS Data ..... 66
- 3.7 Boot Options..... 67
- 3.8 USB Legacy Support ..... 68
- 3.9 BIOS Security Features ..... 69

### 3.1 Introduction

The board uses an Intel/AMI BIOS, which is stored in flash memory and can be upgraded using a disk-based program. In addition to the BIOS, the flash memory contains the BIOS Setup program, POST, the PCI auto-configuration utility, and Plug and Play support.

This board supports system BIOS shadowing, allowing the BIOS to execute from 64-bit onboard write-protected DRAM.

The BIOS displays a message during POST identifying the type of BIOS and a revision code. The initial production BIOS is identified as MO81010A.86A.

---

<b>For information about</b>	<b>Refer to</b>
------------------------------	-----------------

The board's compliance level with Plug and Play
---

Table 2, page 13
------------------

---

## 3.2 BIOS Flash Memory Organization

The Intel 82802AB Firmware Hub (FWH) includes a 4 Mbit (512 KB) symmetrical flash memory device. Internally, the device is grouped into eight 64-KB blocks that are individually erasable, lockable, and unlockable. Figure 11 shows the organization of the flash memory.

The last two 8 KB blocks of the fault tolerance area are the parameter blocks. These blocks contain data such as BIOS updates, vital product data (VPD), logo, System Management BIOS (SMBIOS) interface, and extended system configuration data (ESCD) information. The backup block contains a copy of the fault tolerance block.

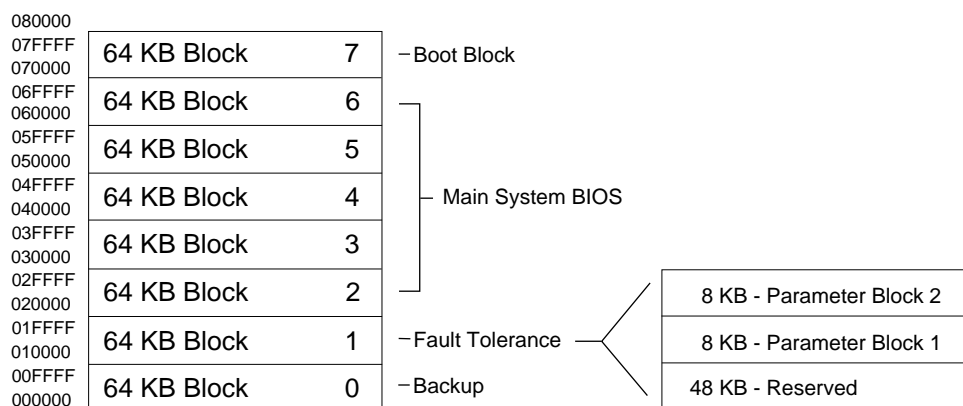

OM08376

Figure 11. Memory Map of the Flash Memory Device

## 3.3 Resource Configuration

### 3.3.1 PCI Autoconfiguration

The BIOS can automatically configure PCI devices. PCI devices may be onboard or add-in cards. Autoconfiguration lets a user insert or remove PCI cards without having to configure the system. When a user turns on the system after adding a PCI card, the BIOS automatically configures interrupts, the I/O space, and other system resources.

PCI devices can share an interrupt. Autoconfiguration information is stored in ESCD format.

#### For information about

The board's compliance level with Plug and Play

#### Refer to

Table 2, page 13

### 3.3.2 PCI IDE Support

If you select Auto in the BIOS Setup program, the BIOS automatically sets up the two PCI IDE connectors with independent I/O channel support. The primary IDE interface supports hard drives up to ATA/66 and recognizes any ATAPI devices, including CD-ROM drives, tape drives, and Ultra DMA drives. The secondary IDE interface supports to ATA/33. The BIOS determines the capabilities of each drive and configures them to optimize capacity and performance. To take advantage of the high capacities typically available today, hard drives are automatically configured for Logical Block Addressing (LBA) and to PIO Mode 3 or 4, depending on the capability of the drive. You can override the auto-configuration options by specifying manual configuration in the BIOS Setup program.

To use ATA-66 features the following items are required:

- An ATA-66 peripheral device
- An ATA-66 compatible cable
- ATA-66 operating system device drivers

For information about	Refer to
The supported version of ATAPI	Table 2, page 13

#### ⇒ NOTE

*Do not connect an ATA device as a slave on the same IDE cable as an ATAPI master device. For example, do not connect an ATA hard drive as a slave to an ATAPI CD-ROM drive.*

## 3.4 System Management BIOS (SMBIOS)

SMBIOS is a Desktop Management Interface (DMI) compliant method for managing computers in a managed network.

The main component of SMBIOS is the management information format (MIF) database, which contains information about the computing system and its components. Using SMBIOS, a system administrator can obtain the system types, capabilities, operational status, and installation dates for system components. The MIF database defines the data and provides the method for accessing this information. The BIOS enables applications such as Intel® LANDesk® Client Manager to use SMBIOS. The BIOS stores and reports the following SMBIOS information:

- BIOS data, such as the BIOS revision level
- Fixed-system data, such as peripherals, serial numbers, and asset tags
- Resource data, such as memory size, cache size, and processor speed
- Dynamic data, such as event detection and error logging

Non-Plug and Play operating systems, such as Windows NT<sup>†</sup>, require an additional interface for obtaining the SMBIOS information. The BIOS supports an SMBIOS table interface for such operating systems. Using this support, an SMBIOS service-level application running on a non-Plug and Play operating system can obtain the SMBIOS information.

---

<b>For information about</b>	<b>Refer to</b>
------------------------------	-----------------

The board's compliance level with SMBIOS	Section 1.3, page 13
--	----------------------

## 3.5 BIOS Upgrades

The BIOS can be upgraded using the Intel® Flash Memory Update utility that is available from Intel. This utility supports the following BIOS maintenance functions:

- Upgrading the flash BIOS from bootable recovery media
- Changing the language section of the BIOS
- Verifying that the upgrade BIOS matches the target system to prevent accidentally installing an incompatible BIOS
- Updating the BIOS boot block

BIOS upgrades and the Intel Flash Memory Update utility are available from Intel through the Intel World Wide Web site.

### ⇒ NOTE

*Please review the instructions distributed with the upgrade utility before attempting a BIOS upgrade.*

For information about	Refer to
The Intel World Wide Web site	Section 1.2, page 13

### 3.5.1 Language Support

The BIOS Setup program and help messages are supported in five languages: US English, German, Italian, French, and Spanish. The default language is US English, which is present unless another language is selected in the BIOS Setup program.

### 3.5.2 Custom Splash Screen

During POST, an Intel splash screen is displayed by default. This splash screen can be replaced with a custom splash screen. A utility is available from Intel to assist with creating a custom splash screen. The custom splash screen can be programmed into the flash memory using the BIOS upgrade utility. Information about this capability is available on the Intel Support World Wide Web site.

For information about	Refer to
The Intel World Wide Web site	Section 1.2, page 13

## 3.6 Recovering BIOS Data

Some types of failure can destroy the BIOS. For example, the data can be lost if a power outage occurs while the BIOS is being upgraded in flash memory. The BIOS can be recovered from either a 1.44 MB diskette (for recovery from an LS-120 diskette drive configured as an ATAPI removable IDE device) or from a CD-ROM (for use in an ATAPI CD-ROM drive) using the BIOS recovery mode. When recovering the BIOS, be aware of the following:

- Recovery requires the use of bootable media in a bootable device.
- Because of the small amount of code available in the nonerasable boot block area, there is no video support. You can only monitor this procedure by listening to the speaker or looking at the recovery drive LED.
- Two beeps indicate the beginning of the BIOS recovery process.
- Two beeps and the end of activity in the recovery drive indicate successful BIOS recovery.
- A series of continuous beeps indicates a failed BIOS recovery.

BIOS recovery media can be either a 1.44 MB diskette or a CD-ROM. The recovery media must be bootable and it must contain the BIOS update files copied to it. BIOS upgrades and the Intel Flash Memory Upgrade utility are available from Intel Customer Support through the Intel World Wide Web site.

### ⇒ NOTE

*BIOS recovery cannot be accomplished using non-SPD DIMMs. SPD data structure is required for the recovery process.*

### ⇒ NOTE

*If the computer is configured to boot from an LS-120 diskette (in the Boot menu), the BIOS recovery diskette must be a standard 1.44 MB diskette not a 120 MB diskette.*

For information about	Refer to
The BIOS recovery mode	Section 2.9, page 49
The Boot menu in the BIOS Setup program	Section 4.7, page 85
Contacting Intel customer support	Section 1.2, page 13

## 3.7 Boot Options

In the BIOS Setup program, the user can choose to boot from an ATAPI removable media device, hard drives, CD-ROM, or the network. Boot devices are defined in priority order. The default setting is for the CD-ROM drive to be the primary boot device and the hard drive to be the secondary boot device.

### 3.7.1 CD-ROM and Network Boot

Booting from CD-ROM is supported in compliance to the El Torito bootable CD-ROM format specification. The network can also be selected as a boot device. This selection allows booting from a network add-in card with a remote boot ROM installed.

<b>For information about</b>	<b>Refer to</b>
The El Torito specification	Section 1.3, page 13

### 3.7.2 Booting Without Attached Devices

For use in embedded applications, the BIOS has been designed so that after passing the POST, the operating system loader is invoked even if the keyboard and mouse are not connected.

## 3.8 USB Legacy Support

USB legacy support enables USB devices such as keyboards, mice, and hubs to be used even when no operating system USB drivers are in place. By default, USB legacy support is set to Auto. USB legacy support is used in accessing the BIOS Setup program and installing an operating system that supports USB.

This sequence describes how USB legacy support operates in the default (auto) mode.

1. When you power up the computer, USB legacy support is disabled.
2. POST begins.
3. USB legacy support is temporarily enabled by the BIOS. This allows you to use a USB keyboard to enter the BIOS Setup program or the maintenance mode.
4. POST completes and disables USB legacy support (unless it was set to Enabled while in the BIOS Setup program. Or if set to Auto while in the BIOS Setup program and a USB keyboard or mouse is connected, then USB Legacy support will be enabled).
5. The operating system loads. While the operating system is loading, USB keyboards and mice are not recognized (unless USB legacy support was set to Enabled while in the BIOS Setup program, or if USB legacy support was set to Auto while in the BIOS Setup program and a USB keyboard or mouse is connected). After the operating system loads the USB drivers, the USB devices are recognized by the operating system.

To install an operating system that supports USB, enable USB Legacy support or set it to Auto in the BIOS Setup program and follow the operating system's installation instructions. Once the operating system is installed and the USB drivers have been configured, USB legacy support is no longer used. USB Legacy support can be left enabled or set to auto in the BIOS Setup program if needed.

Notes on using USB legacy support:

- Do not use USB devices with an operating system that does not support USB. USB legacy is not intended to support the use of USB devices in a non-USB aware operating system.
- USB legacy support is for keyboards, mice, and hubs only. Other USB devices are not supported.

## 3.9 BIOS Security Features

The BIOS includes security features that restrict access to the BIOS Setup program and who can boot the computer. A supervisor password and a user password can be set for the BIOS Setup program and for booting the computer, with the following restrictions:

- The supervisor password gives unrestricted access to view and change all the Setup options in the BIOS Setup program. This is supervisor mode.
- The user password gives restricted access to view and change Setup options in the BIOS Setup program. This is user mode.
- If only the supervisor password is set, pressing the <Enter> key at the password prompt of the BIOS Setup program allows the user restricted access to Setup.
- If both the supervisor and user passwords are set, users can enter either the supervisor password or the user password to access Setup. Users have access to Setup respective to which password is entered.
- Setting the user password restricts who can boot the computer. The password prompt will be displayed before the computer is booted. If only the supervisor password is set, the computer boots without asking for a password. If both passwords are set, the user can enter either password to boot the computer.

Table 41 shows the effects of setting the supervisor password and user password. This table is for reference only and is not displayed on the screen.

**Table 41. Supervisor and User Password Functions**

Password Set	Supervisor Mode	User Mode	Setup Options	Password to Enter Setup	Password During Boot
Neither	Can change all options *	Can change all options *	None	None	None
Supervisor only	Can change all options	Can change a limited number of options	Supervisor Password	Supervisor	None
User only	N/A	Can change all options	Enter Password Clear User Password	User	User
Supervisor and user set	Can change all options	Can change a limited number of options	Supervisor Password Enter Password	Supervisor or user	Supervisor or user

\* If no password is set, any user can change all Setup options.

For information about	Refer to
Setting user and supervisor passwords	Section 4.4.5, page 82



# 4 BIOS Setup Program

---

## What This Chapter Contains

4.1	Introduction.....	71
4.2	Maintenance Menu .....	72
4.3	Main Menu.....	74
4.4	Advanced Menu.....	75
4.5	Security Menu.....	83
4.6	Power Menu .....	84
4.7	Boot Menu .....	85
4.8	Exit Menu .....	87

### 4.1 Introduction

The BIOS Setup program can be used to view and change the BIOS settings for the computer. The BIOS Setup program is accessed by pressing the <F2> key after the Power-On Self-Test (POST) memory test begins and before the operating system boot begins. The menu bar is shown below.

Maintenance	Main	Advanced	Security	Power	Boot	Exit
-------------	------	----------	----------	-------	------	------

Table 42 lists the BIOS Setup program menu functions.

**Table 42. BIOS Setup Program Menu Functions**

Maintenance	Main	Advanced	Security	Power	Boot	Exit
Clears passwords and BIS credentials, enables extended configuration modes	Allocates resources for hardware components	Configures advanced features available through the chipset	Sets passwords and security features	Configures power management features	Selects boot options and power supply controls	Saves or discards changes to Setup program options

⇒ **NOTE**

*The Setup screens described in this chapter apply to boards with BIOS identifier MO81010A.86A. Boards with other BIOS identifiers might have differences in some of the Setup screens.*

⇒ **NOTE**

*In this chapter, all examples of the BIOS Setup Program menu bar include the maintenance menu; however, the maintenance menu is displayed only when the board is in configuration mode. Section 2.9 on page 49 tells how to put the board in configuration mode.*

Table 43 lists the function keys available for menu screens.

**Table 43. BIOS Setup Program Function Keys**

BIOS Setup Program Function Key	Description
<←> or <→>	Selects a different menu screen
<↑> or <↓>	Selects an item
<Tab>	Selects a field
<Enter>	Executes command or selects a submenu
<F9>	Load the default configuration values for the current menu
<F10>	Save the current values and exits the BIOS Setup program
<Esc>	Exits the menu

## 4.2 Maintenance Menu

To access this menu, select `Maintenance` on the menu bar at the top of the screen.

<b>Maintenance</b>	Main	Advanced	Security	Power	Boot	Exit
Extended Configuration						

The menu shown in Table 44 is for clearing the Setup passwords and the Wired for Management Boot Integrity Service credentials, and for changing extended configuration memory settings. Setup only displays this menu in configuration mode. See Section 2.9 on page 49 for configuration mode setting information.

**Table 44. Maintenance Menu**

Feature	Options	Description
▶ Clear All Passwords	Confirm: Yes/No	Selecting <i>Yes</i> clears the user and supervisor passwords.
▶ Clear BIS Credentials (Note)	Confirm: Yes/No	Selecting <i>Yes</i> clears the WfM BIS (Boot Integrity Service) credentials.
▶ Extended Configuration	(See Extended Configuration Submenu)	Selecting <i>User-Defined</i> allows setting system control and video memory cache modes.
CPU Information:		
CPU Microcode Update Revision	No options	Displays CPU's Microcode Update Revision.
CPU Stepping Signature	No options	Displays CPU's Stepping Signature.

Note: For information about the BIS, refer to the Intel web site at:

<http://developer.intel.com/design/security/index1.htm>

## 4.2.1 Extended Configuration Submenu

To access this submenu, select `Maintenance` on the menu bar, then `Extended Configuration`.

<b>Maintenance</b>	Main	Advanced	Security	Power	Boot	Exit
<b>Extended Configuration</b>						

The submenu represented by Table 45 is for setting system control and video memory cache mode. This submenu becomes available when `User-Defined` is selected under `Extended Configuration`.

**Table 45. Extended Configuration Submenu**

Feature	Options	Description
Extended Configuration	<ul style="list-style-type: none"> <li>• <b>Default (default)</b></li> <li>• User-Defined</li> </ul>	Selecting user-defined allows you to select <i>Default</i> or <i>User-Defined</i> . Selecting <i>User-Defined</i> allows you to configure the items listed under Memory Control below. Note: If <i>User-Defined</i> is selected, the status will be displayed in the Advanced Menu as: "Extended Configuration: Used."
Memory Control: SDRAM Auto Configuration	<ul style="list-style-type: none"> <li>• <b>Auto (default)</b></li> <li>• User-Defined</li> </ul>	Sets extended memory configuration options to auto or user-defined.
CAS# Latency	<ul style="list-style-type: none"> <li>• 3</li> <li>• 2</li> <li>• <b>Auto (default)</b></li> </ul>	Selects the number of clock cycles required to address a column in memory.
SDRAM RAS# to CAS# delay	<ul style="list-style-type: none"> <li>• 3</li> <li>• 2</li> <li>• <b>Auto (default)</b></li> </ul>	Selects the number of clock cycles between addressing a row and addressing a column.
SDRAM RAS# Precharge	<ul style="list-style-type: none"> <li>• 3</li> <li>• 2</li> <li>• <b>Auto (default)</b></li> </ul>	Selects the length of time required before accessing a new row.

## 4.3 Main Menu

To access this menu, select `Main` on the menu bar at the top of the screen.

Maintenance	<b>Main</b>	Advanced	Security	Power	Boot	Exit
-------------	-------------	----------	----------	-------	------	------

Table 46 describes the Main menu. This menu reports processor and memory information and is for configuring the system date and system time.

**Table 46. Main Menu**

Feature	Options	Description
BIOS Version	No options	Displays the version of the BIOS.
Processor Type	No options	Displays processor type.
Processor Speed	No options	Displays processor speed.
System Bus Frequency	No options	Displays the host bus frequency.
Cache RAM	No options	Displays the size of second-level cache.
Total Memory	No options	Displays the total amount of RAM on the board.
Memory Bank 0	No options	Displays type of DIMM installed.
Language	English	Displays the current language.
Processor Serial Number	<ul style="list-style-type: none"> <li>• <b>Disabled (default)</b></li> <li>• Enabled</li> </ul>	When enabled, displays the processor's serial number. (Not supported by all processor types and speeds.)
System Time	Hour, minute, and second	Specifies the current time.
System Date	Day of the week, month, day, and year	Specifies the current date.

## 4.4 Advanced Menu

To access this menu, select `Advanced` on the menu bar at the top of the screen.

Maintenance	Main	<b>Advanced</b>	Security	Power	Boot	Exit
		Boot Configuration				
		Peripheral Configuration				
		IDE Configuration				
		Event Log Configuration				
		Video Configuration				

Table 47 describes the Advanced menu. This menu is used for setting advanced features that are available through the chipset.

**Table 47. Advanced Menu**

Feature	Options	Description
Extended Configuration	No options	Indicates the setting of the Extended Configuration submenu (from the Maintenance Menu) <i>Used</i> indicates that the Extended Configuration submenu is being used. <i>Not Used</i> (the default) indicates that the Extended Configuration submenu is not being used.
▶ Boot Configuration	No options	Configures Plug and Play and the Numlock key, and resets configuration data. When selected, displays the Boot Settings Configuration submenu.
▶ Peripheral Configuration	No options	Configures peripheral ports and devices. When selected, displays the Peripheral Configuration submenu.
▶ IDE Configuration	No options	Specifies type of connected IDE device.
▶ Event Log Configuration	No options	Configures Event Logging. When selected, displays the Event Log Configuration submenu.
▶ Video Configuration	No options	Specifies the primary video adapter.

#### 4.4.1 Boot Configuration Submenu

To access this submenu, select *Advanced* on the menu bar, then *Boot Configuration*.

Maintenance	Main	<b>Advanced</b>	Security	Power	Boot	Exit
		<b>Boot Configuration</b>				
		Peripheral Configuration				
		IDE Configuration				
		Event Log Configuration				
		Video Configuration				

The submenu represented by Table 48 is for setting Plug and Play options, resetting configuration data, and the power-on state of the Numlock key.

**Table 48. Boot Configuration Submenu**

Feature	Options	Description
Plug & Play O/S	<ul style="list-style-type: none"> <li>• <b>No (default)</b></li> <li>• Yes</li> </ul>	Specifies if a Plug and Play operating system is being used. <i>No</i> lets the BIOS configure all devices. <i>Yes</i> lets the operating system configure Plug and Play devices. Not required with Plug and Play operating systems.
Reset Config Data	<ul style="list-style-type: none"> <li>• <b>No (default)</b></li> <li>• Yes</li> </ul>	Clears the BIOS configuration data on the next boot.
Numlock	<ul style="list-style-type: none"> <li>• Off</li> <li>• <b>On (default)</b></li> </ul>	Specifies the power on state of the Numlock feature on the numeric keypad of the keyboard.

## 4.4.2 Peripheral Configuration Submenu

To access this submenu, select *Advanced* on the menu bar, then *Peripheral Configuration*.

Maintenance	Main	<b>Advanced</b>	Security	Power	Boot	Exit
		Boot Configuration				
		<b>Peripheral Configuration</b>				
		IDE Configuration				
		Event Log Configuration				
		Video Configuration				

The submenu represented in Table 49 is used for enabling the onboard serial port, audio and LAN devices, and legacy USB support.

**Table 49. Peripheral Configuration Submenu**

Feature	Options	Description
Serial Port A	<ul style="list-style-type: none"> <li>• Disabled</li> <li>• Enabled</li> <li>• <b>Auto (default)</b></li> </ul>	Enables or disables the serial port.
Base I/O address	<ul style="list-style-type: none"> <li>• <b>3F8 (default)</b></li> <li>• 2F8</li> <li>• 3E8</li> <li>• 2E8</li> </ul>	Specifies the base I/O address for the serial port. This option appears only when Serial Port A is set to <i>Enabled</i> .
Interrupt	<ul style="list-style-type: none"> <li>• IRQ 3</li> <li>• <b>IRQ 4 (default)</b></li> </ul>	Specifies the interrupt assigned to the serial port. This option appears only when Serial Port A is set to <i>Enabled</i> .
Audio Device	<ul style="list-style-type: none"> <li>• Disabled</li> <li>• <b>Enabled (default)</b></li> </ul>	Enables or disables the onboard audio subsystem.
LAN Device	<ul style="list-style-type: none"> <li>• Disabled</li> <li>• <b>Enabled (default)</b></li> </ul>	Enables or disable the onboard LAN controller.
Legacy USB Support	<ul style="list-style-type: none"> <li>• Disabled</li> <li>• <b>Enabled (default)</b></li> </ul>	Enables or disables USB legacy support. (See Section 3.8 on page 68 for more information.)

### 4.4.3 IDE Configuration Submenu

To access this submenu, select **Advanced** on the menu bar, then **IDE Configuration**.

Maintenance	Main	<b>Advanced</b>	Security	Power	Boot	Exit
		Boot Configuration				
		Peripheral Configuration				
		<b>IDE Configuration</b>				
		Primary IDE Master				
		Primary IDE Slave				
		Secondary IDE Master				
		Secondary IDE Slave				
		Diskette Configuration				
		Event Log Configuration				
		Video Configuration				

The menu represented in Table 50 is used to configure IDE device options.

**Table 50. IDE Configuration Submenu**

Feature	Options	Description
IDE Controller	<ul style="list-style-type: none"> <li>• Disabled</li> <li>• Primary</li> <li>• Secondary</li> <li>• <b>Both (default)</b></li> </ul>	Specifies the integrated IDE controller. <i>Primary</i> enables only the Primary IDE Controller. <i>Secondary</i> enables only the Secondary IDE Controller. <i>Both</i> enables both IDE controllers.
Hard Disk Pre-Delay	<ul style="list-style-type: none"> <li>• <b>Disabled (default)</b></li> <li>• 3 Seconds</li> <li>• 6 Seconds</li> <li>• 9 Seconds</li> <li>• 12 Seconds</li> <li>• 15 Seconds</li> <li>• 21 Seconds</li> <li>• 30 Seconds</li> </ul>	Specifies the hard disk drive pre-delay.
▶ Primary IDE Master	No options	Reports type of connected IDE device. When selected, displays the Primary IDE Master submenu.
▶ Primary IDE Slave	No options	Reports type of connected IDE device. When selected, displays the Primary IDE Slave submenu.
▶ Secondary IDE Master	No options	Reports type of connected IDE device. When selected, displays the Secondary IDE Master submenu.
▶ Secondary IDE Slave	No options	Reports type of connected IDE device. When selected, displays the Secondary IDE Slave submenu.

### 4.4.3.1 Primary/Secondary IDE Master/Slave Submenus

To access these submenus, select **Advanced** on the menu bar, then **IDE Configuration** and then the master or slave to be configured.

Maintenance	Main	<b>Advanced</b>	Security	Power	Boot	Exit
		Boot Configuration				
		Peripheral Configuration				
		<b>IDE Configuration</b>				
		Primary IDE Master				
		Primary IDE Slave				
		Secondary IDE Master				
		Secondary IDE Slave				
		Diskette Configuration				
		Event Log Configuration				
		Video Configuration				

There are four IDE submenus: primary master, primary slave, secondary master, and secondary slave. Table 51 shows the format of the IDE submenus. For brevity, only one example is shown.

**Table 51. Primary/Secondary IDE Master/Slave Submenus**

Feature	Options	Description
Type	<ul style="list-style-type: none"> <li>• None</li> <li>• User</li> <li>• <b>Auto (default)</b></li> <li>• CD-ROM</li> <li>• ATAPI Removable</li> <li>• Other ATAPI</li> <li>• IDE Removable</li> </ul>	<p>Specifies the IDE configuration mode for IDE devices.</p> <p><i>User</i> allows the user to change the other features in this table.</p> <p><i>Auto</i> automatically sets the other features in this table.</p> <p>Any setting other than <i>None</i> or <i>Auto</i> enables the user to set features.</p>
LBA Mode Control	<ul style="list-style-type: none"> <li>• Disabled</li> <li>• <b>Enabled (default)</b></li> </ul>	Enables or disables the LBA mode control.
Multi-Sector Transfers	<ul style="list-style-type: none"> <li>• Disabled</li> <li>• 2 Sectors</li> <li>• 4 Sectors</li> <li>• 8 Sectors</li> <li>• <b>16 Sectors (default)</b></li> </ul>	<p>Specifies number of sectors per block for transfers from the hard disk drive to memory.</p> <p>Check the hard disk drive's specifications for optimum setting.</p>

continued

**Table 51. Primary/Secondary IDE Master/Slave Submenus (continued)**

Feature	Options	Description
PIO Mode	<ul style="list-style-type: none"> <li>• <b>Auto (default)</b></li> <li>• 0</li> <li>• 1</li> <li>• 2</li> <li>• 3</li> <li>• 4</li> </ul>	<p>Configures the PIO mode.</p> <p>Auto sets the PIO mode to the fastest speed supported.</p>
Ultra DMA	<ul style="list-style-type: none"> <li>• <b>Disabled (default)</b></li> <li>• Mode 0</li> <li>• Mode 1</li> <li>• Mode 2</li> <li>• Mode 3</li> <li>• Mode 4</li> </ul>	<p>Specifies the Ultra DMA mode for the drive.</p>
Use ARMD Drive As	<ul style="list-style-type: none"> <li>• Auto</li> <li>• <b>Floppy (default)</b></li> <li>• Hard Disk</li> </ul>	<p>Specifies the type of ARMD drive.</p> <p>This option appears only if an ARMD drive is attached to an IDE interface.</p>

#### 4.4.4 Event Log Configuration

To access this menu, select **Advanced** on the menu bar, then **Event Log Configuration**.

Maintenance	Main	<b>Advanced</b>	Security	Power	Boot	Exit
		Boot Configuration				
		Peripheral Configuration				
		IDE Configuration				
		<b>Event Log Configuration</b>				
		Video Configuration				

The submenu represented by Table 52 is used to configure the event logging features.

**Table 52. Event Log Configuration Submenu**

Feature	Options	Description
Event log	No options	Indicates if there is space available in the event log.
Event log validity	No options	Indicates if the contents of the event log are valid.
View event log	[Enter]	Displays the event log.
Clear all event logs	<ul style="list-style-type: none"> <li>• <b>No (default)</b></li> <li>• Yes</li> </ul>	Clears the event log after rebooting.
Event Logging	<ul style="list-style-type: none"> <li>• Disabled</li> <li>• <b>Enabled (default)</b></li> </ul>	Enables logging of events.
Mark events as read	[Enter]	Marks all events as read.

### 4.4.5 Video Configuration

To access this menu, select **Advanced** on the menu bar, then **Video Configuration**.

Maintenance	Main	<b>Advanced</b>	Security	Power	Boot	Exit
		Boot Configuration				
		Peripheral Configuration				
		IDE Configuration				
		Event Log Configuration				
		<b>Video Configuration</b>				

The submenu represented by Table 52 is used to select the video adapter.

**Table 53. Video Configuration Submenu**

Feature	Options	Description
Primary Video Adapter	<ul style="list-style-type: none"> <li>• <b>AGP (default)</b></li> <li>• PCI</li> </ul>	Selects the Direct AGP or PCI video controller as the display device that will be active when the systems boots.

## 4.5 Security Menu

To access this menu, select *Security* from the menu bar at the top of the screen.

Maintenance	Main	Advanced	<b>Security</b>	Power	Boot	Exit
-------------	------	----------	-----------------	-------	------	------

The menu represented by Table 54 is for setting passwords and security features.

**Table 54. Security Menu**

Feature	Options	Description
Supervisor Password Is	No options.	Reports if there is a supervisor password set.
User Password Is	No options.	Reports if there is a user password set.
Set Supervisor Password	Password can be up to seven alphanumeric characters.	Specifies the supervisor password.
Set User Password	Password can be up to seven alphanumeric characters.	Specifies the user password.
Clear User Password (Note 1)	<ul style="list-style-type: none"> <li>• <b>Yes (default)</b></li> <li>• No</li> </ul>	Clears the user password.
User Access Level (Note 2)	<ul style="list-style-type: none"> <li>• Limited</li> <li>• No Access</li> <li>• View Only</li> <li>• <b>Full (default)</b></li> </ul>	Sets BIOS Setup Utility access rights for user level.
Unattended Start (Note 1)	<ul style="list-style-type: none"> <li>• <b>Disabled (default)</b></li> <li>• Enabled</li> </ul>	Enables or disables Wake on network event capability. The keyboard remains locked until a password is entered.

Notes:

1. This feature appears only if a user password has been set.
2. This feature appears only if both a user password and a supervisor password have been set.

## 4.6 Power Menu

To access this menu, select `Power` from the menu bar at the top of the screen.

Maintenance	Main	Advanced	Security	<b>Power</b>	Boot	Exit
-------------	------	----------	----------	--------------	------	------

The menu represented in Table 55 is for setting the power management features.

**Table 55. Power Menu**

Feature	Options	Description
ACPI Suspend State	<ul style="list-style-type: none"> <li>• <b>S1 State (default)</b></li> <li>• S3 State</li> </ul>	Specifies the ACPI suspend state

## 4.7 Boot Menu

To access this menu, select `Boot` from the menu bar at the top of the screen.

Maintenance	Main	Advanced	Security	Power	<b>Boot</b>	Exit
						IDE Drive Configuration

The menu represented in Table 56 is used to set the boot features and the boot sequence.

**Table 56. Boot Menu**

Feature	Options	Description
Quiet Boot	<ul style="list-style-type: none"> <li>Disabled</li> <li><b>Enabled (default)</b></li> </ul>	<p><i>Disabled</i> displays normal POST messages.</p> <p><i>Enabled</i> displays the OEM logo instead of POST messages.</p>
Quick Boot	<ul style="list-style-type: none"> <li>Disabled</li> <li><b>Enabled (default)</b></li> </ul>	Enables the computer to boot without running certain POST tests.
Scan User Flash Area	<ul style="list-style-type: none"> <li><b>Disabled (default)</b></li> <li>Enabled</li> </ul>	Enables the BIOS to scan the flash memory for user binary files that are executed at boot time.
After Power Failure	<ul style="list-style-type: none"> <li>Stays Off</li> <li><b>Last State (default)</b></li> <li>Power On</li> </ul>	<p>Specifies the mode of operation if an AC/Power loss occurs.</p> <p><i>Power On</i> restores power to the computer.</p> <p><i>Stay Off</i> keeps the power off until the power button is pressed.</p> <p><i>Last State</i> restores the previous power state before power loss occurred.</p>
On PME	<ul style="list-style-type: none"> <li><b>Stay Off (default)</b></li> <li>Power On</li> </ul>	Specifies how the computer responds to a PME wakeup event when the power is off (from an ACPI S3 state).

continued

**Table 56. Boot Menu** (continued)

Feature	Options	Description
First Boot Device Second Boot Device Third Boot Device Fourth Boot Device	<ul style="list-style-type: none"> <li>• ARMD-FDD (Note 1)</li> <li>• ARMD-HDD (Note 2)</li> <li>• IDE-HDD</li> <li>• ATAPI CDROM</li> <li>• Intel UNDI, PXE 2.0 (Note 3)</li> <li>• Disabled</li> </ul>	<p>Specifies the boot sequence according to the device type. The computer will attempt to boot from up to four devices as specified here. Only one of the devices can be an IDE hard disk drive.</p> <p>To specify the boot sequence:</p> <ol style="list-style-type: none"> <li>1. Select the boot device with &lt;↑&gt; or &lt;↓&gt;.</li> <li>2. Press &lt;Enter&gt; to set the selection as the intended boot device.</li> </ol> <p>The default settings for the first through fourth boot devices are, respectively:</p> <ul style="list-style-type: none"> <li>• ATAPI CDROM</li> <li>• IDE-HDD</li> <li>• Intel UNDI, PXE 2.0 (build 071)</li> <li>• Disabled</li> </ul> <p><b>NOTE:</b> To configure the computer to boot from an IDE hard disk drive, set a boot device in this Setup feature to IDE-HDD. Determine the IDE channel, and master or slave mode of the drive. Then, in the next Setup feature, IDE Drive Configuration, set that channel and mode to 1<sup>st</sup> IDE.</p>
<ul style="list-style-type: none"> <li>▶ IDE Drive Configuration <ul style="list-style-type: none"> <li>Primary Master IDE</li> <li>Primary Slave IDE</li> <li>Secondary Master IDE</li> <li>Secondary Slave IDE</li> </ul> </li> </ul>	<ul style="list-style-type: none"> <li>• <b>1<sup>st</sup> IDE (default)</b></li> <li>• 2<sup>nd</sup> IDE</li> <li>• 3<sup>rd</sup> IDE</li> <li>• 4<sup>th</sup> IDE</li> </ul>	<p>1<sup>st</sup> IDE specifies the IDE hard disk drive to boot from. The 2<sup>nd</sup> through 4<sup>th</sup> IDE settings are ignored. See the note above for more information.</p> <p>To specify the drive to boot from:</p> <ol style="list-style-type: none"> <li>1. Use &lt;↑&gt; or &lt;↓&gt; to select the channel, and master or slave mode of the drive to boot from.</li> <li>2. Press &lt;Enter&gt;.</li> <li>3. Use &lt;↑&gt; or &lt;↓&gt; to select 1<sup>st</sup> IDE.</li> <li>4. Press &lt;Enter&gt; to set the selection.</li> </ol>

## Notes:

1. ARMD-FDD = ATAPI removable device - floppy disk drive (LS-120)
2. ARMD-HDD = ATAPI removable device - hard disk drive
3. UNDI = Universal network interface card (NIC) driver interface  
PXE = Pre-boot execution environment

## 4.8 Exit Menu

To access this menu, select `Exit` from the menu bar at the top of the screen.

Maintenance	Main	Advanced	Security	Power	Boot	<b>Exit</b>
-------------	------	----------	----------	-------	------	-------------

The menu represented in Table 57 is for exiting the BIOS Setup program, saving changes, and loading and saving defaults.

**Table 57. Exit Menu**

Feature	Description
Exit Saving Changes	Exits and saves the changes in CMOS SRAM.
Exit Discarding Changes	Exits without saving any changes made in the BIOS Setup program.
Load Setup Defaults	Loads the factory default values for all the Setup options.
Load Custom Defaults	Loads the custom defaults for Setup options.
Save Custom Defaults	Saves the current values as custom defaults. Normally, the BIOS reads the Setup values from flash memory. If this memory is corrupted, the BIOS reads the custom defaults. If no custom defaults are set, the BIOS reads the factory defaults.
Discard Changes	Discards changes without exiting Setup. The option values present when the computer was turned on are used.



# 5 Error Messages and Beep Codes

---

## What This Chapter Contains

5.1	BIOS Error Messages.....	89
5.2	Port 80h POST Codes.....	91
5.3	Bus Initialization Checkpoints .....	95
5.4	Speaker.....	96
5.5	BIOS Beep Codes .....	97

## 5.1 BIOS Error Messages

Table 58 lists the error messages and provides a brief description of each.

**Table 58. BIOS Error Messages**

Error Message	Explanation
GA20 Error	An error occurred with Gate-A20 when switching to protected mode during the memory test.
Pri Master HDD Error Pri Slave HDD Error Sec Master HDD Error Sec Slave HDD Error	Could not read sector from corresponding drive.
Pri Master Drive - ATAPI Incompatible Pri Slave Drive - ATAPI Incompatible Sec Master Drive - ATAPI Incompatible Sec Slave Drive - ATAPI Incompatible	Corresponding drive is not an ATAPI device. Run Setup to make sure device is selected correctly.
Cache Memory Bad	An error occurred when testing L2 cache. Cache memory may be bad.
CMOS Battery Low	The battery may be losing power. Replace the battery soon.
CMOS Display Type Wrong	The display type is different than what has been stored in CMOS. Check Setup to make sure type is correct.
CMOS Checksum Bad	The CMOS checksum is incorrect. CMOS memory may have been corrupted. Run Setup to reset values.
CMOS Settings Wrong	CMOS values are not the same as the last boot. These values have either been corrupted or the battery has failed.
CMOS Date/Time Not Set	The time and/or date values stored in CMOS are invalid. Run Setup to set correct values.
DMA Error	Error during read/write test of DMA controller.
HDC Failure	Error occurred trying to access hard disk controller.

continued

**Table 58. BIOS Error Messages** (continued)

<b>Error Message</b>	<b>Explanation</b>
Checking NVRAM.....	NVRAM is being checked to see if it is valid.
Update OK!	NVRAM was invalid and has been updated.
Updated Failed	NVRAM was invalid but was unable to be updated.
Keyboard Error	Error in the keyboard connection. Make sure keyboard is connected properly.
Memory Size Decreased	Memory size has decreased since the last boot. If no memory was removed then memory may be bad.
Memory Size Increased	Memory size has increased since the last boot. If no memory was added there may be a problem with the system.
Memory Size Changed	Memory size has changed since the last boot. If no memory was added or removed then memory may be bad.
No Boot Device Available	System did not find a device to boot.
Off Board Parity Error	A parity error occurred on an offboard card. This error is followed by an address.
On Board Parity Error	A parity error occurred in onboard memory. This error is followed by an address.
Parity Error	A parity error occurred in onboard memory at an unknown address.
NVRAM / CMOS / PASSWORD cleared by Jumper	NVRAM, CMOS, and passwords have been cleared. The system should be powered down and the jumper removed.
<CTRL_N> Pressed	CMOS is ignored and NVRAM is cleared. User must enter Setup.

## 5.2 Port 80h POST Codes

During the POST, the BIOS generates diagnostic progress codes (POST-codes) to I/O port 80h. If the POST fails, execution stops and the last POST code generated is left at port 80h. This code is useful for determining the point where an error occurred.

Displaying the POST-codes requires an add-in card (often called a POST card). The POST card can decode the port and display the contents on a medium such as a seven-segment display.

The tables below offer descriptions of the POST codes generated by the BIOS. Table 59 defines the Uncompressed INIT Code Checkpoints, Table 60 describes the Boot Block Recovery Code Checkpoints, and Table 61 lists the Runtime Code Uncompressed in F000 Shadow RAM. Some codes are repeated in the tables because that code applies to more than one operation.

**Table 59. Uncompressed INIT Code Checkpoints**

Code	Description of POST Operation
D0	NMI is disabled. Onboard KBC, RTC enabled (if present). Init code Checksum verification starting.
D1	Keyboard controller BAT test, CPU ID saved, and going to 4 GB flat mode.
D3	Do necessary chipset initialization, start memory refresh, do memory sizing.
D4	Verify base memory.
D5	Init code to be copied to segment 0 and control to be transferred to segment 0.
D6	Control is in segment 0. To check recovery mode and verify main BIOS checksum. If the BIOS is in recovery mode or the main BIOS checksum is bad, go to check point E0 for recovery else go to check point D7 for giving control to main BIOS.
D7	Find main BIOS module in ROM image.
D8	Uncompress the main BIOS module.
D9	Copy main BIOS image to F000 shadow RAM and give control to main BIOS in F000 shadow RAM.

**Table 60. Boot Block Recovery Code Checkpoints**

Code	Description of POST Operation
E0	Onboard floppy controller (if any) is initialized. Compressed recovery code is uncompressed in F000:0000 in shadow RAM and give control to recovery code in F000 Shadow RAM. Initialize interrupt vector tables, initialize system timer, initialize DMA controller, interrupt controller.
E8	Initialize extra (Intel Recovery) Module.
E9	Initialize floppy drive.
EA	Try to boot from floppy. If reading of boot sector is successful, give control to boot sector code.
EB	Booting from floppy failed, look for ATAPI (LS-120, Zip <sup>†</sup> ) devices.
EC	Try to boot from ATAPI. If reading of boot sector is successful, give control to boot sector code.
EF	Booting from floppy and ATAPI device failed. Give two beeps. Retry the booting procedure again (go to check point E9).

**Table 61. Runtime Code Uncompressed in F000 Shadow RAM**

<b>Code</b>	<b>Description of POST Operation</b>
03	NMI is Disabled. To check soft reset/power-on.
05	BIOS stack set. Going to disable cache if any.
06	POST code to be uncompressed.
07	CPU init and CPU data area init to be done.
08	CMOS checksum calculation to be done next.
0B	Any initialization before keyboard BAT to be done next.
0C	KB controller I/B free. To issue the BAT command to keyboard controller.
0E	Any initialization after KB controller BAT to be done next.
0F	Keyboard command byte to be written.
10	Going to issue Pin-23, 24 blocking/unblocking command.
11	Going to check pressing of <INS>, <END> key during power-on.
12	To init CMOS if "Init CMOS in every boot" is set or <END> key is pressed. Going to disable DMA and Interrupt controllers.
13	Video display is disabled and port-B is initialized. Chipset init about to begin.
14	8254 timer test about to start.
19	About to start memory refresh test.
1A	Memory Refresh line is toggling. Going to check 15 $\mu$ s ON/OFF time.
23	To read 8042 input port and disable Megakey GreenPC feature. Make BIOS code segment writeable.
24	To do any setup before Int vector init.
25	Interrupt vector initialization to begin. To clear password if necessary.
27	Any initialization before setting video mode to be done.
28	Going for monochrome mode and color mode setting.
2A	Different buses init (system, static, output devices) to start if present. (See Section 5.3 for details of different buses.)
2B	To give control for any setup required before optional video ROM check.
2C	To look for optional video ROM and give control.
2D	To give control to do any processing after video ROM returns control.
2E	If EGA/VGA not found then do display memory R/W test.
2F	EGA/VGA not found. Display memory R/W test about to begin.
30	Display memory R/W test passed. About to look for the retrace checking.
31	Display memory R/W test or retrace checking failed. To do alternate display memory R/W test.
32	Alternate display memory R/W test passed. To look for the alternate display retrace checking.
34	Video display checking over. Display mode to be set next.
37	Display mode set. Going to display the power on message.
38	Different buses init (input, IPL, general devices) to start if present. (See Section 5.3 for details of different buses.)
39	Display different buses initialization error messages. (See Section 5.3 for details of different buses.)
3A	New cursor position read and saved. To display the Hit <DEL> message.

continued

**Table 61. Runtime Code Uncompressed in F000 Shadow RAM (continued)**

Code	Description of POST Operation
40	To prepare the descriptor tables.
42	To enter in virtual mode for memory test.
43	To enable interrupts for diagnostics mode.
44	To initialize data to check memory wrap around at 0:0.
45	Data initialized. Going to check for memory wrap around at 0:0 and finding the total system memory size.
46	Memory wrap around test done. Memory size calculation over. About to go for writing patterns to test memory.
47	Pattern to be tested written in extended memory. Going to write patterns in base 640 K memory.
48	Patterns written in base memory. Going to find out amount of memory below 1 M memory.
49	Amount of memory below 1 M found and verified. Going to find out amount of memory above 1 M memory.
4B	Amount of memory above 1 M found and verified. Check for soft reset and going to clear memory below 1 M for soft reset. (If power on, go to check point # 4Eh).
4C	Memory below 1 M cleared. (SOFT RESET) Going to clear memory above 1 M.
4D	Memory above 1 M cleared. (SOFT RESET) Going to save the memory size. (Go to check point # 52h).
4E	Memory test started. (NOT SOFT RESET) About to display the first 64 K memory size.
4F	Memory size display started. This will be updated during memory test. Going for sequential and random memory test.
50	Memory testing/initialization below 1 M complete. Going to adjust displayed memory size for relocation/ shadow.
51	Memory size display adjusted due to relocation/shadow. Memory test above 1 M to follow.
52	Memory testing/initialization above 1 M complete. Going to save memory size information.
53	Memory size information is saved. CPU registers are saved. Going to enter in real mode.
54	Shutdown successful, CPU in real mode. Going to disable gate A20 line and disable parity/NMI.
57	A20 address line, parity/NMI disable successful. Going to adjust memory size depending on relocation/shadow.
58	Memory size adjusted for relocation/shadow. Going to clear Hit <DEL> message.
59	Hit <DEL> message cleared. <WAIT...> message displayed. About to start DMA and interrupt controller test.
60	DMA page register test passed. To do DMA#1 base register test.
62	DMA#1 base register test passed. To do DMA#2 base register test.
65	DMA#2 base register test passed. To program DMA unit 1 and 2.
66	DMA unit 1 and 2 programming over. To initialize 8259 interrupt controller.
7F	Extended NMI sources enabling is in progress.
80	Keyboard test started. Clearing output buffer, checking for stuck key, to issue keyboard reset command.
81	Keyboard reset error/stuck key found. To issue keyboard controller interface test command.
82	Keyboard controller interface test over. To write command byte and init circular buffer.
83	Command byte written, global data init done. To check for lock-key.

continued

**Table 61. Runtime Code Uncompressed in F000 Shadow RAM (continued)**

<b>Code</b>	<b>Description of POST Operation</b>
84	Lock-key checking over. To check for memory size mismatch with CMOS.
85	Memory size check done. To display soft error and check for password or bypass setup.
86	Password checked. About to do programming before setup.
87	Programming before setup complete. To uncompress SETUP code and execute CMOS setup.
88	Returned from CMOS setup program and screen is cleared. About to do programming after setup.
89	Programming after setup complete. Going to display power on screen message.
8B	First screen message displayed. <WAIT...> message displayed. PS/2 Mouse check and extended BIOS data area allocation to be done.
8C	Setup options programming after CMOS setup about to start.
8D	Going for hard disk controller reset.
8F	Hard disk controller reset done. Floppy setup to be done next.
91	Floppy setup complete. Hard disk setup to be done next.
95	Init of different buses optional ROMs from C800 to start. (See Section 5.3 for details of different buses.)
96	Going to do any init before C800 optional ROM control.
97	Any init before C800 optional ROM control is over. Optional ROM check and control will be done next.
98	Optional ROM control is done. About to give control to do any required processing after optional ROM returns control and enable external cache.
99	Any initialization required after optional ROM test over. Going to setup timer data area and printer base address.
9A	Return after setting timer and printer base address. Going to set the RS-232 base address.
9B	Returned after RS-232 base address. Going to do any initialization before coprocessor test.
9C	Required initialization before coprocessor is over. Going to initialize the coprocessor next.
9D	Coprocessor initialized. Going to do any initialization after coprocessor test.
9E	Initialization after coprocessor test is complete. Going to check extended keyboard, keyboard ID, and Num Lock.
A2	Going to display any soft errors.
A3	Soft error display complete. Going to set keyboard typematic rate.
A4	Keyboard typematic rate set. To program memory wait states.
A5	Going to enable parity/NMI.
A7	NMI and parity enabled. Going to do any initialization required before giving control to optional ROM at E000.
A8	Initialization before E000 ROM control over. E000 ROM to get control next.
A9	Returned from E000 ROM control. Going to do any initialization required after E000 optional ROM control.
AA	Initialization after E000 optional ROM control is over. Going to display the system configuration.
AB	Put INT13 module runtime image to shadow.
AC	Generate MP for multiprocessor support (if present).
AD	Put CGA INT10 module (if present) in shadow.

continued

**Table 61. Runtime Code Uncompressed in F000 Shadow RAM (continued)**

Code	Description of POST Operation
AE	Uncompress SMBIOS module and init SMBIOS code and form the runtime SMBIOS image in shadow.
B1	Going to copy any code to specific area.
00	Copying of code to specific area done. Going to give control to INT19 boot loader.

### 5.3 Bus Initialization Checkpoints

The system BIOS gives control to the different buses at several checkpoints to do various tasks. Table 62 describes the bus initialization checkpoints.

**Table 62. Bus Initialization Checkpoints**

Checkpoint	Description
2A	Different buses init (system, static, and output devices) to start if present.
38	Different buses init (input, IPL, and general devices) to start if present.
39	Display different buses initialization error messages.
95	Init of different buses optional ROMs from C800 to start.

While control is inside the different bus routines, additional checkpoints are output to port 80h as a WORD to identify the routines under execution. In these WORD checkpoints, the low byte of the checkpoint is the system BIOS checkpoint from which the control is passed to the different bus routines. The high byte of the checkpoint is the indication of which routine is being executed in the different buses. Table 63 describes the upper nibble of the high byte and indicates the function that is being executed.

**Table 63. Upper Nibble High Byte Functions**

Value	Description
0	func#0, disable all devices on the bus concerned
1	func#1, static devices init on the bus concerned
2	func#2, output device init on the bus concerned
3	func#3, input device init on the bus concerned
4	func#4, IPL device init on the bus concerned
5	func#5, general device init on the bus concerned
6	func#6, error reporting for the bus concerned
7	func#7, add-on ROM init for all buses

Table 64 describes the lower nibble of the high byte and indicates the bus on which the routines are being executed.

**Table 64. Lower Nibble High Byte Functions**

Value	Description
0	Generic DIM (Device Initialization Manager)
1	Onboard system devices
2	ISA devices
3	EISA devices
4	ISA PnP devices
5	PCI devices

## 5.4 Speaker

A 47  $\Omega$  inductive speaker is mounted on the board. The speaker provides audible error code (beep code) information during the power-on self-test (POST).

For information about	Refer to
The location of the onboard speaker	Figure 1, page 11

## 5.5 BIOS Beep Codes

Whenever a recoverable error occurs during power-on self-test (POST), the BIOS displays an error message describing the problem (see Table 65). The BIOS also issues a beep code (one long tone followed by two short tones) during POST if the video configuration fails (a faulty video card or no card installed) or if an external ROM module does not properly checksum to zero.

An external ROM module (for example, a video BIOS) can also issue audible errors, usually consisting of one long tone followed by a series of short tones. For more information on the beep codes issued, check the documentation for that external device.

There are several POST routines that issue a POST terminal error and shut down the system if they fail. Before shutting down the system, the terminal-error handler issues a beep code signifying the test point error, writes the error to I/O port 80h, attempts to initialize the video and writes the error in the upper left corner of the screen (using both monochrome and color adapters).

If POST completes normally, the BIOS issues one short beep before passing control to the operating system.

**Table 65. Beep Codes**

Beep	Description
1	Refresh failure
2	Parity cannot be reset
3	First 64 KB memory failure
4	Timer not operational
5	Not used
6	8042 GateA20 cannot be toggled
7	Exception interrupt error
8	Display memory R/W error
9	Not used
10	CMOS Shutdown register test error
11	Invalid BIOS (e.g. POST module not found, etc.)

