

Notice

The manufacturer reserves the right to make any updates, revisions or changes to the information contained herein as and when deemed necessary. The manufacturer is under no obligation to notify any purchaser or end-user of such actions in advance or afterwards.

1998

Trademarks

IBM PC, OS/2, PS/2, EGA, and VGA are registered trademarks of International Business Machines Corporation.

Intel, Pentium are trademarks of Intel Corporation.

MS-DOS, Microsoft Windows, Windows NT and Microsoft Mouse are registered trademarks of Microsoft Corporation.

Sound Blaster Pro is a trademark of Creative Labs, Inc.

SystemSoft is a registered trademark of SystemSoft Corp.

Other brand and product names are trademarks of their respective companies.

FCC Notice

This equipment has been tested and found to comply with the limits for a Class B digital device, pursuant to Part 15 of the FCC Rules. These limits are designed to provide reasonable protection against harmful interference in a residential installation. This equipment generates, uses, and can radiate radio frequency energy and, if not installed and used in accordance with the instructions, may cause harmful interference to radio communications. However, there is no guarantee that interference will not occur in a particular installation. If this equipment does cause harmful interference to radio or television reception, which can be determined by turning the equipment off and on, the user is encouraged to try to correct the interference by one or more of the following measures:

- Reorient or relocate the receiving antenna.
- Increase the separation between the equipment and receiver.
- Connect the equipment into an outlet on a circuit different from that to which the receiver is connected.
- Consult the dealer or an experienced radio/TV technician for help.

CE – Certificate

This equipment is in compliance with the requirements of the following regulation:

EN 55 022: CLASS B

Warranty Provisions

Keep the product's bar code legible to protect your right for warranty services.

The manufacturer warrants this personal computer to be in working order for a period of one year from the date of shipment. If this product fails within the one year warranty period the manufacturer will, at its option, repair or replace the product at no charge except as set forth below.

Warranty service will be furnished on an exchange basis. The manufacturer may repair or replace your product with a new or reconditioned one. Any replaced components or parts become the property of the manufacturer.

No warranty is expressed or implied for products damaged by accident, abuse, misuse, acts of god, or un-authorized modification. No warranties apply after the one year warranty period.

To obtain warranty service described herein, deliver the product along with proof of purchase date, to any of the manufacturer's authorized distributors during the warranty period. The owner agrees to insure the product and assume the risk of damage or loss in transit, to pay in advance all shipping charges, and to use the original shipping container (or the equivalent).

The manufacturer is not liable to any purchaser or end-user for any damages including, but not limited to, lost revenue, lost wages, lost savings, or any other incidental or consequential damages arising from the purchase, use, or inability to use this product.

Important Safety Instructions

Please read and follow these important instructions.

1. Follow all warnings and instructions marked on this product.
2. Unplug this product from the wall outlet before cleaning it or connecting peripheral devices.
3. Use a damp cloth with mild soap to clean this product. Do not apply cleaner directly to the unit. Do not use volatile or abrasive cleaners on this product.
4. Do not place this product on an unstable surface where it may fall.
5. Do not block or cover the system's ventilation openings. Also, never place this product near or over a radiator or heat register, or in a built-in installation unless adequate ventilation is provided.
6. Operate this product in accordance with its rated power specifications. If you are unsure of your local power specifications, consult your dealer or local power company.
7. This product is equipped with a 3-wire grounding type plug. This is an important safety feature; do not defeat its purpose. If you do not have access to such power, have a qualified electrician install a proper outlet.
8. Do not allow anything to rest on the power cord. Do not locate this product where persons will likely walk on the cord.
9. If an extension cord is used with this product, make sure the total current drawn by the products plugged into the extension cord do not exceed the extension cord or outlet power ratings.

10. Do not allow foreign matter to enter the system.
11. Do not attempt to service this product yourself. Opening or removing covers may expose dangerous voltage points. Refer all repair work to qualified service personnel.
12. Unplug this product from the wall outlet, do not operate it, and immediately seek proper servicing if:
 - The power cord or plug is damaged or frayed.
 - Liquid or foreign matter has entered this product.
 - This product has been exposed to rain or water.
 - This product has been dropped or damaged.
 - This product exhibits a distinct change in performance, indicating a need for service.
13. Do not use any battery pack other than the one specifically designed for this system. Batteries may explode or leak if exposed to fire or improperly handled or guarded. Refer battery replacement to your dealer or qualified service personnel.
14. Only use UL listed/CSA certified, type SVT/SJT power cords rated 6A 250V minimum (VDE approved or equivalent). It should be a detachable type with a minimum length of 6 feet.
15. Adjust only those controls that are covered by these operating instructions. Improper adjustment of other controls may result in serious damage to the system and are not covered by the warranty.

Conventions

This manual uses the following conventions to describe, identify, and highlight terms and operating procedures.

Text Conventions

Text in boldface contains messages that are important for safe operation. Please read.

Characters in boldface represent specific items or keys, e.g. **CardBus**, **Fn** key.

File names are presented in bold capitals, e.g. **A:\>0VMAKFIL /Pn**.

Abbreviations

For the purpose of clarity, abbreviations are enclosed in parentheses following their definition; for example, Enhanced Parallel Port (EPP) mode.

Icons

Icons identify ports and jacks of the Notebook computer. The system status indicators are also identified with their relative icons.

Keys

Keys appear in boldface. A plus sign (+) between two keys indicates that they should be pressed simultaneously.

Messages

Note: A note is an advice that helps you make best use of your Notebook computer. Please read.

Ergonomics

Developing good work habits are important if you need to work in front of the computer for long periods of time. Improper work habits can result in discomfort or serious injury from repetitive strain to your hands, wrists or other joints. The following are some tips to reduce the strain:

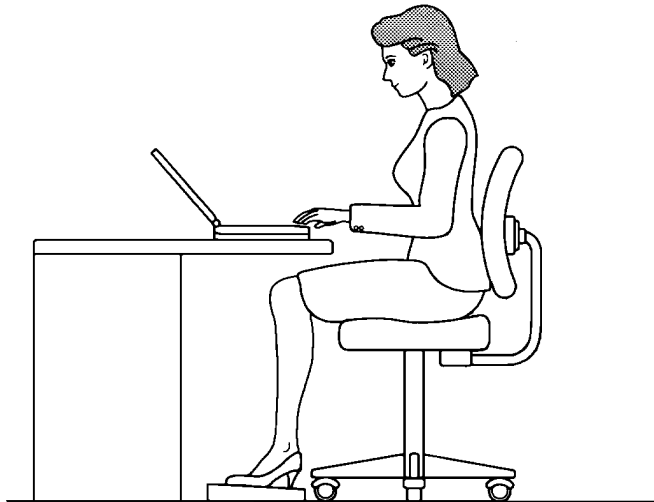

- Adjust the height of the chair and/or desk so that the keyboard is at or slightly below the level of your elbow. Keep your forearms, wrists, and hands in a relaxed position.
- Your knees should be slightly higher than your hips. Place your feet flat on the floor or on a footrest if necessary.
- Use a chair with a back and adjust it to support your lower back comfortably.
- Sit straight so that your knees, hips and elbows form approximately 90° angles when you are working.

Lighting

Proper lighting and comfortable display viewing angle can reduce eye strain and muscle fatigue in your neck and shoulders.

- Position the display to avoid glare or reflections from overhead lighting or outside sources of light.
- Keep the display screen clean and set the brightness and contrast to levels that allow you to see the screen clearly.
- Position the display directly in front of you at a comfortable viewing distance.
- Adjust the display viewing angle to find the best position.

In addition, continuous concentration on computing work can result in discomfort and injury. Remember to:

- Alter your posture frequently.
- Stretch and exercise your body several times a day.
- Take periodic breaks when you work at the computer for long periods of time. Frequent and short breaks are of greater benefit than fewer and longer breaks.

Table of Contents

Chapter 1: Getting Started

Unpacking	1-2
Operating Environment	1-3
Quick Start-up	1-4
Powering the System	1-4
AC Power Adapter	1-4
Battery Pack	1-5
Inserting	1-5
Removing	1-5
Recharging by AC Power	1-6
Proper Handling of the Battery Pack	1-6
Opening the LCD Cover	1-7
LED Indicators on the LCD Cover	1-8
Top-Front View	1-9
LCD Panel	1-9
Stereo Speakers	1-9
Trackpad and Buttons	1-9
Keyboard	1-9
Microphone	1-9
System Status LED Indicators	1-10
Power Button	1-10
Rear View	1-12
Headphone Jack	1-12
Microphone-in Jack	1-12
Security Connector	1-12
PS/2 Type Port	1-12
Serial Port	1-12
Parallel Port	1-12
External Monitor (CRT) Port	1-12
USB Port	1-12
Right-side View	1-14
3.5" Floppy Diskette Drive	1-14
5.25" CD-ROM Drive	1-14

PC Card Sockets.....	1-14
Right-side Stands	1-14
Left-side View	1-16
DC-in Socket	1-16
Ventilation.....	1-16
Left-side Stands.....	1-16
Bottom View	1-17
2.5” Hard Disk Drive	1-17
CPU Cover	1-17
Battery Pack.....	1-17
CD-ROM Cover	1-17

Chapter 2: Operation

Upgrading CPU.....	2-2
Replacing CPU.....	2-2
Setting DIP Switch.....	2-4
Accessing the 10-Pole DIP Switch.....	2-4
CPU Core Frequency Settings	2-5
Flash ROM BIOS Settings	2-5
Accessing the 8-Pole DIP Switch.....	2-6
CPU Core Voltage Settings	2-6
Accessing the 2-Pole DIP Switch.....	2-7
CPU I/O Voltage Settings.....	2-7
Expanding Memory.....	2-8
Accessing the Memory Sockets.....	2-9
Installing Memory Module	2-10
Removing Memory Module	2-11
Using Hard Disk Drive	2-12
Removing.....	2-12
Inserting.....	2-12
Replacing Hard Disk Drive	2-13
Using Floppy Disk Drive	2-14
Inserting/Removing Diskettes.....	2-14
Write-Protecting Diskettes	2-15
Do’s and Don’ts	2-15
Using CD-ROM.....	2-16
Removing CD-ROM Module	2-17

Loading Compact Discs	2-18
Handling of Compact Discs	2-19
Using PC Card Sockets	2-20
Inserting PC Cards.....	2-20
Removing PC Cards	2-21
Using Hot Keys	2-22
Using Numeric Keypad.....	2-24
Windows 95 Special Keys	2-25
Application Key.....	2-25
Windows Key.....	2-25
LCD Panel.....	2-26
Using Power Management.....	2-27
Advanced Power Management (APM 1.2).....	2-27
Advanced Configuration and Power Interface (ACPI).....	2-27
Hard Disk Standby	2-28
Global Standby.....	2-28
Suspend and Resume	2-28
Powered On Suspend (POS).....	2-29
Resume from POS Mode	2-29
Suspend To RAM (STR).....	2-29
Resume from STR Mode	2-29
Suspend To Disk (STD).....	2-30
Resume from STD Mode.....	2-30
Attaching Peripheral Devices	2-31
Attaching a Security Lock	2-31
Attaching a PS/2 Keyboard or Mouse.....	2-32
Attaching a Serial Mouse.....	2-33
Attaching a Parallel Printer.....	2-34
Attaching an External Monitor (CRT)	2-35
Attaching a USB-compatible Device.....	2-36

Chapter 3: BIOS Utilities

Power On Self Test (POST)	3-2
POST Message: Normal Operation.....	3-2
POST Message: Error Detected.....	3-3
System Configuration Utility.....	3-4
Information in the System Configuration Utility.....	3-4

Initiating the System Configuration Utility.....	3-5
Working with the Menu Bar of the SCU.....	3-6
Working with the Pull-down Menu of the SCU.....	3-7
Features of the System Configuration Utility.....	3-8
Startup Menu.....	3-8
Memory Menu.....	3-10
Disks Menu	3-11
Components Menu.....	3-12
Power Menu.....	3-15
Exit Menu	3-18









Appendix A: Specifications	A-1
---	------------

Appendix B: I/O Port Pin Assignments	B-1
---	------------

Index

Chapter 1: Getting Started

This chapter provides a short introduction and tutorial that will familiarize you with the Notebook system and get you up and running quickly. This Chapter will discuss:

-  Unpacking
-  Operating Environment
-  Powering the System by AC Power Adapter
-  Powering the System by Battery Pack
-  Charging the Battery Pack
-  Opening the LCD Cover
-  Identifying all Devices and Ports
-  Identifying all LED Indicators

Unpacking

Carefully unpack the Notebook Computer and the included accessories (Figure 1-1). If there is any discrepancy or problem, contact your dealer immediately. Be sure to save the packing materials in the event that the notebook needs to be shipped at some point in the future.

- Notebook Computer.
- Carrying Bag.
- Power Adapter.
- Power Cord.
- User Manual.
- PS/2 Transfer Cable.
- Battery Pack.
- Utilities Diskettes.
- CD for drivers.

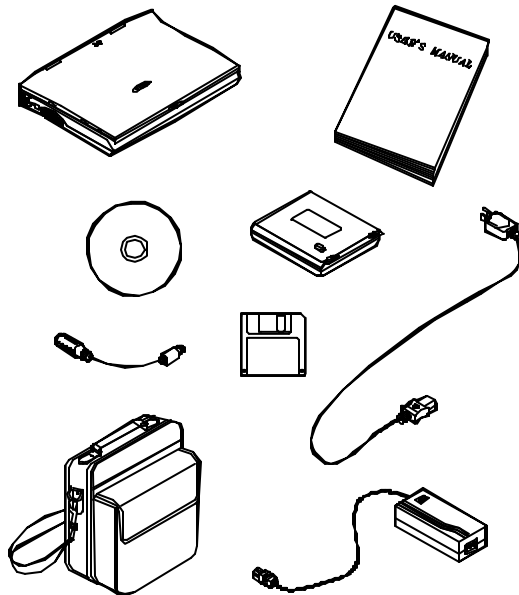

Figure 1-1

Operating Environment

As with any other precision electronic equipment, proper care and operation of your Notebook will provide long and reliable service. Be sure the computer system is not:

- Exposed to excessive heat or direct sunlight.
- Subjected to shock or vibration.
- Exposed to strong magnetic fields.
- Left in a place where foreign matter or moisture may enter the system.

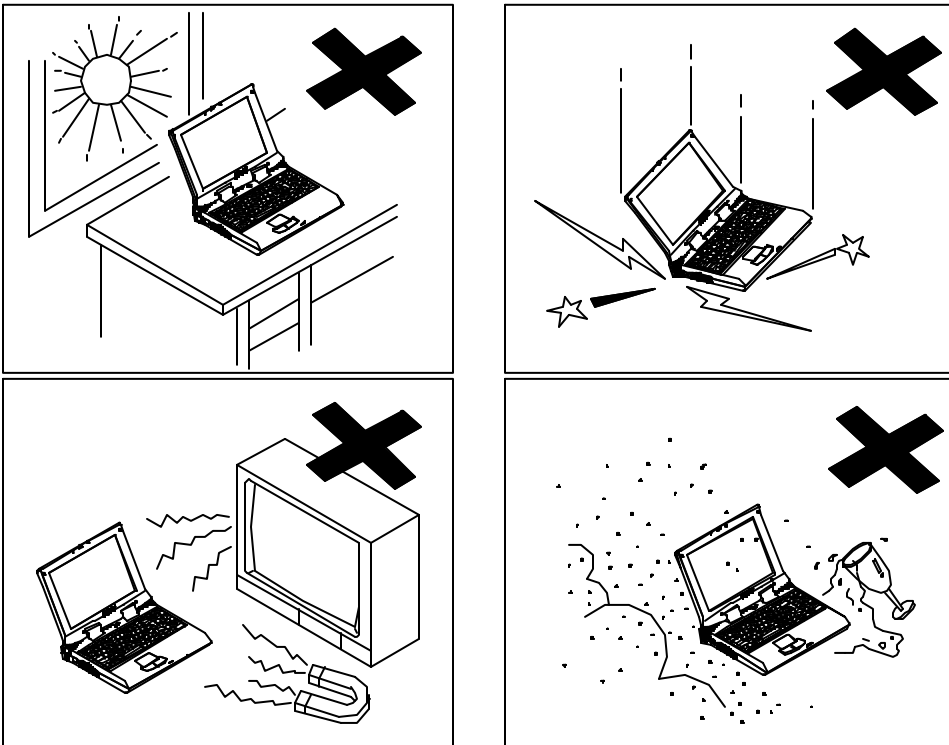

Figure 1-2

Quick Start-up

Powering the System

AC Power Adapter

Use only the power adapter that comes with your Notebook Computer. System operation with an incorrect power adapter will cause damage to the Notebook and its components.

1. Plug the power adapter to the DC-in socket on the left panel of the Notebook.
2. Connect the power cord to the power adapter.
3. Plug the AC power cord into a properly grounded outlet (Figure 1-3).
4. Refer to *Chapter 1, System Status LED Indicators* for more information on system power status.

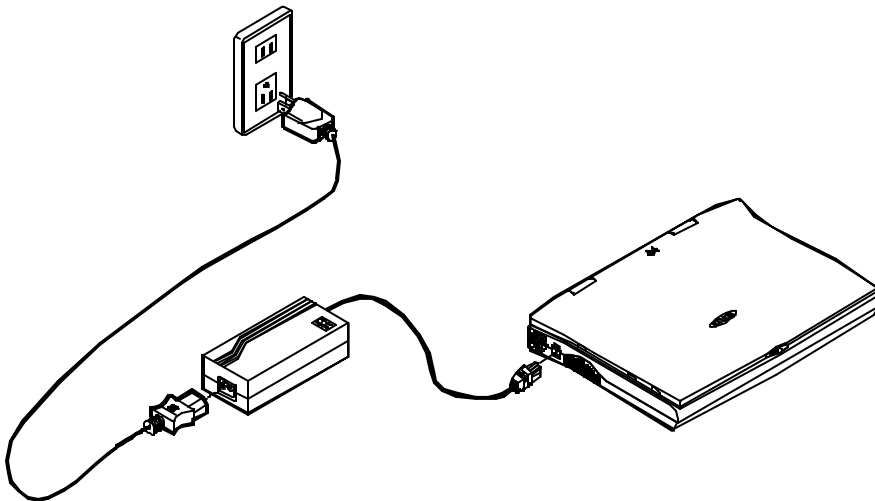

Figure 1-3

Battery Pack

Power for continuous portable operation of the Notebook is provided by a battery pack. When using the battery no external power source is required. However, the actual operating time will be determined by the application used and the configuration set.

Inserting

1. Turn the Notebook over.
2. Position the battery pack and firmly fit it into the Notebook (Figure 1-4).
3. The two latches will click into place when it is seated.

Removing

1. Turn the Notebook over.
2. Press the two latches in the direction indicated to release the battery pack. (Figure 1-5)
3. Carefully lift the battery pack from the Notebook.

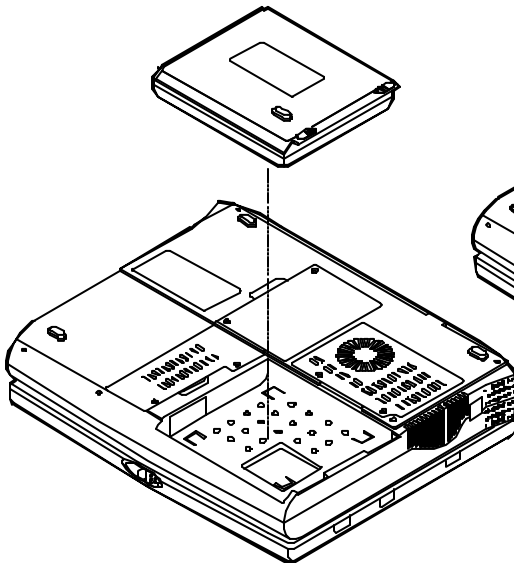

Figure 1-4

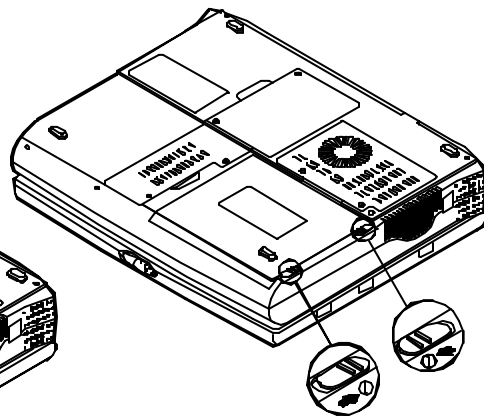

Figure 1-5

Recharging by AC Power

The system's battery pack will recharge whenever the system is plugged into the AC power supply, regardless of whether the system is being operated or not. Please refer to *Chapter 1, System Status LED Indicators* for more information concerning battery charge status.

Off-Line Charge

The Notebook system is powered off. Connect the AC adapter to the unit. Its DC output will be used solely to charge the battery. It will take hours to bring a completely discharged battery to its full charge state.

Trickle Charge

The Notebook system is powered on. Again, make sure the AC adapter is connected to the unit. Its DC output will both power the system and charge the battery. It may take more hours than off-line charge to charge the battery.

Proper Handling of the Battery Pack

- Do not attempt to disassemble the battery under any circumstances.
- The battery may explode if exposed to fire or high temperatures.
- Avoid short circuiting the battery by preventing contact between the metal terminals (+, -).

Opening the LCD Cover

1. To release the top cover slide the latch to the right (Figure 1-6).
2. Lift the top cover to reveal the LCD panel and keyboard (Figure 1-7).
3. Adjust the LCD panel to a comfortable viewing angle.
4. Press the power button to turn the system on or off (refer to *Chapter 1, Top-Front View* for the information of the power button).

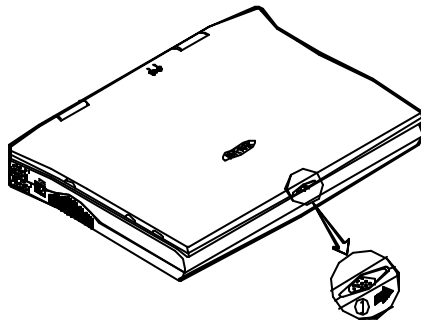

Figure 1-6

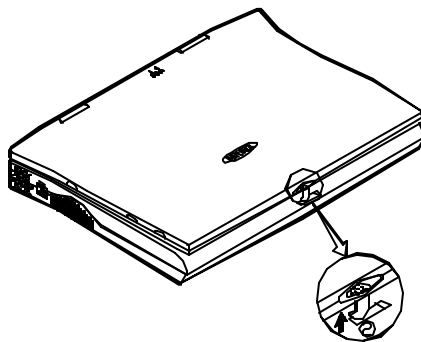

Figure 1-7

LED Indicators on the LCD Cover

Icon	Color	Description
ⓘ	Green	Battery power is used with system turned on.
	Red	AC power is used with system turned on.
🔋	Green	Battery is fully charged.
	Red	Battery is being charged.
	Blinking Red	Battery power is critically low.

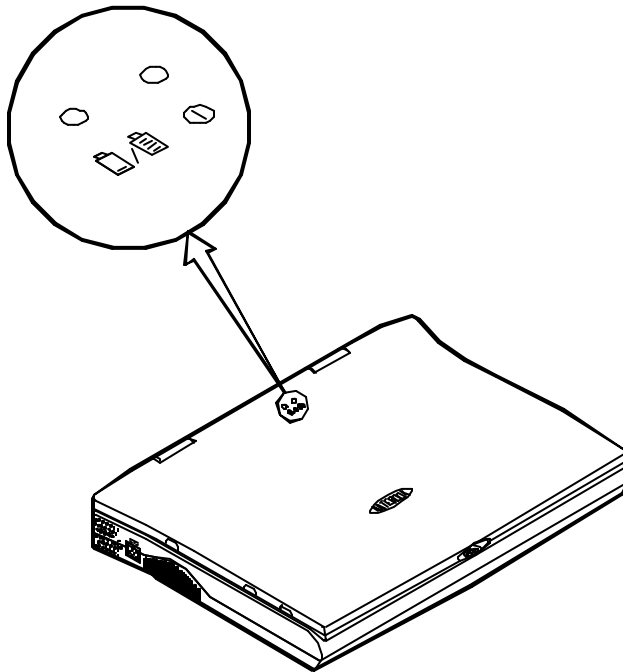

Figure 1-8

Top-Front View

LCD Panel

The Notebook provides you with a large LCD panel. Depending upon the model you have purchased, it can either be a 14.1"/13.3" XGA (1024x768 pixels) compatible, using TFT technology, or a 12.1" SVGA (800x600 pixels) compatible, using DSTN or TFT technology. The LCD panel is driven by a PCI local bus video controller with 4MB video memory.

Stereo Speakers

Two built-in speakers provide clear stereo sound.

Trackpad and Buttons

The pointing device features a sensitive glide pad for precise movements. It functions like a two-button mouse does. The right trackpad button is equivalent to the right mouse button; the left trackpad button is equivalent to the left mouse button.

Keyboard





The Notebook utilizes a Windows 95 keyboard that is integrated with the numeric keypad. It is detachable for various language versions. You may refer to *Chapter 2: Operation* for more information.

Microphone

This is the built-in microphone for recording sound into your applications.

System Status LED Indicators

The LED indicators display the system's operation status.

Icon	Color	Description
	Green	Battery power is used with system turned on.
	Red	AC power is used with system turned on.
	Green	Battery is fully charged.
	Red	Battery is being charged.
	Blinking Red	Battery power is critically low.
	Green	The hard disk is being accessed.
	Green	The system has entered Suspend-To-RAM (STR) or Power-On-Suspend (POS) mode.

Power Button

Icon	Description
	Use this button to turn the system on or off.

Note: After turning off the system, wait for a few seconds to power it on again when you need to.

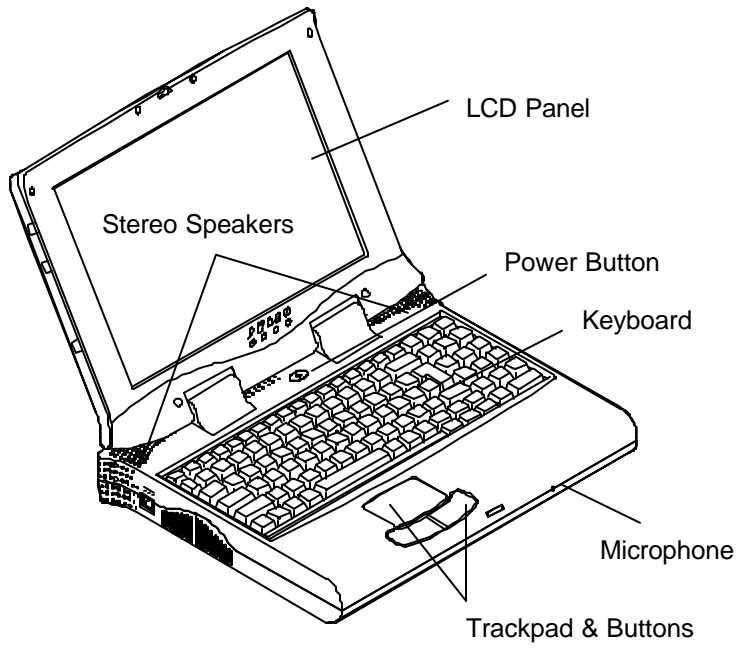

Figure 1-9

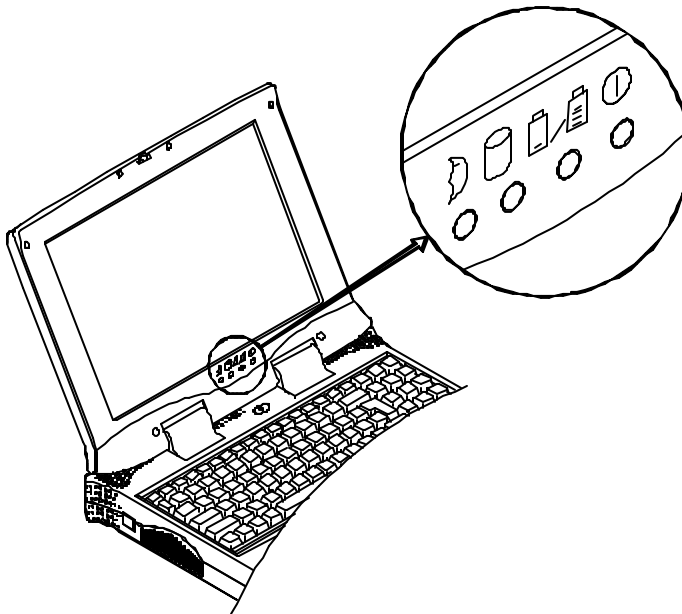

Figure 1-10

Rear View



Microphone-in Jack

Use this jack to connect a microphone to the system for audio input.



Headphone Jack

Headphone can be attached to the system through this jack for audio output, so can external speakers that have built-in output power amplifier.

Security Connector

The Security Connector is used to protect your Notebook from being stolen. Wrap the steel cable around your desk. Next, insert the locking device into this security connector.



PS/2 Type Port

A PS/2 type mouse and keyboard may be connected to the system using this port.

Serial Port



This port is UART 16C550 compatible. It features a 9-pin connector for the addition of an external mouse for example.

Parallel Port



This parallel port supports EPP (Enhanced Parallel Port) and ECP (Extended Capabilities Port) modes.

External Monitor (CRT) Port



This port is used for transmission of the display to an external monitor. Simultaneous display with the LCD panel is available.

USB Port



The Universal Serial Bus (USB) port simplifies the expansion capability for peripherals by daisy-chain connection of a number of USB-equipped devices.

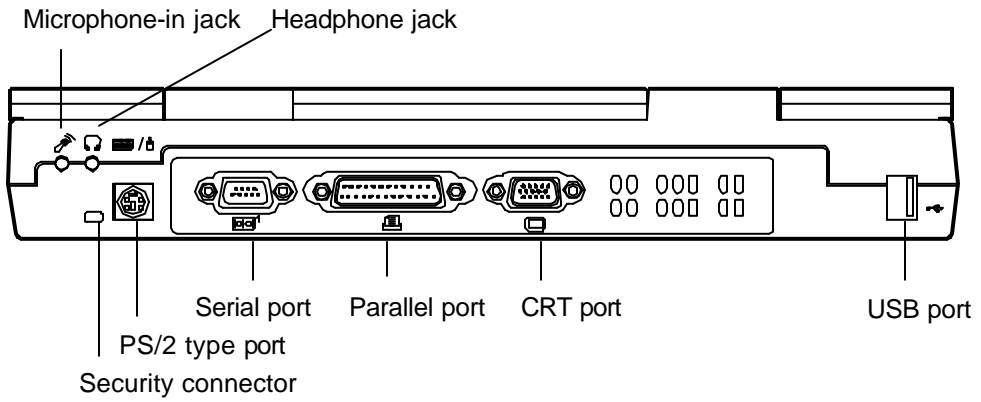

Figure 1-11

Right-side View

3.5" Floppy Diskette Drive

The Notebook comes standard with a 1.44MB floppy drive installed. Press the button on its top-right side to eject the diskette.

5.25" CD-ROM Drive

The 5.25" IDE CD-ROM module is designed to be changeable installing or removing the two screws that fasten the CD-ROM drive. The eject button is located in the middle of the front cover of the CD-ROM drive. Pressing it will release the CD tray. Refer to *Chapter 2: Operation*, for more information.

PC Card Sockets

One Type III or two Type II PC cards may be used. Both sockets will expand the system capabilities when a PC card is inserted. To eject the PC card, press the appropriate eject button (Figure 2-17).

Infrared

The system adopts infrared technology as the interface for simple, fast and convenient data exchange from the Notebook to an infrared-compatible device. It implements IrDA (HPSIR) and Amplitude Shifted Keyed IR (ASKIR). No object should be blocking the line of sight between the Notebook and the infrared-equipped device. For further information, refer to the manual of the wireless device you wish to connect on how to use the point-and-shoot operation.

Right-side Stands

When a high speed CPU is installed, the erecting stands on both sides will help heat dissipation during operation.

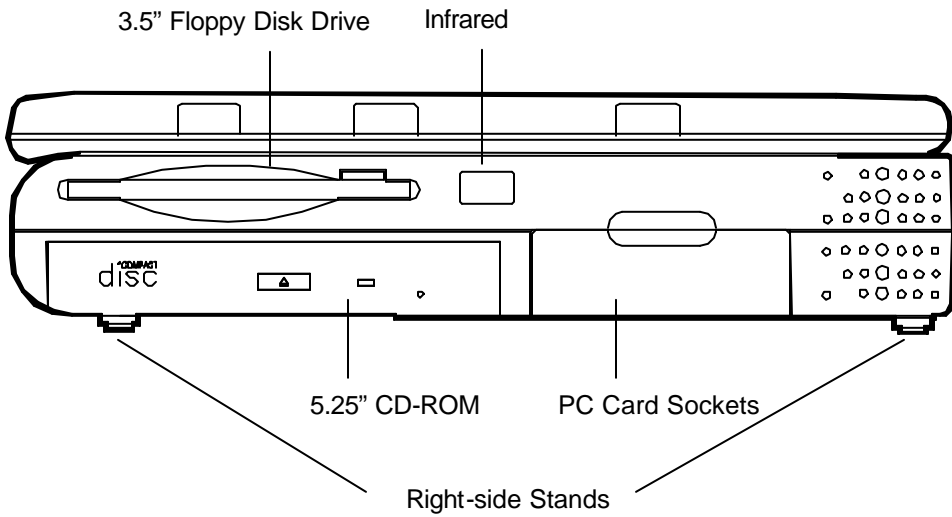

Figure 1-12

Left-side View

== DC-in Socket

Plug the AC adapter into this socket for power supply. To disconnect, pull the plug (not the cord) directly back.

Ventilation

The Notebook provides ventilation to dissipate the system's operating heat. Do not block or obstruct it during operation.

Left-side Stands

When a high speed CPU is installed, the erecting stands on both sides will help heat dissipation during operation.

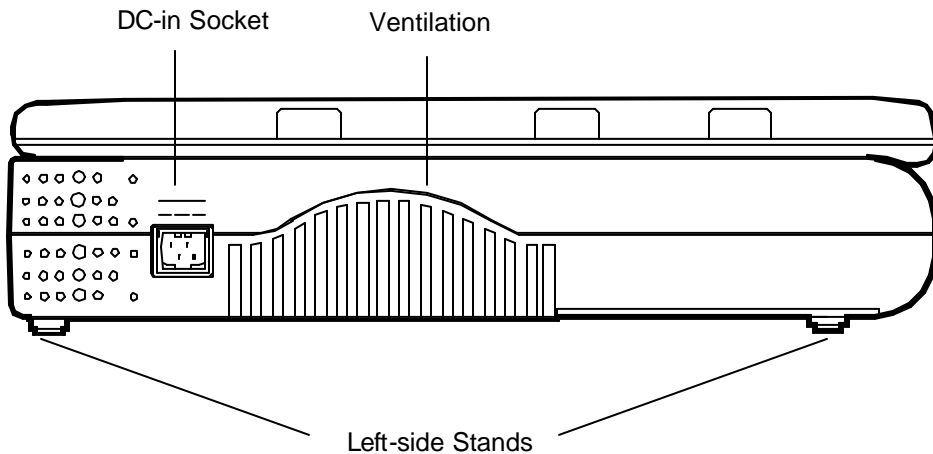

Figure 1-13

Bottom View

2.5" Hard Disk Drive

The 2.5" hard disk drive accepts any 2.5" IDE hard disk drive with a height of 12.7mm or less. Accessing the corresponding screws will allow you to install or to remove this hard disk drive. Refer to *Chapter 2: Operation*, for more information.

CPU Cover

Detaching the screws to remove the cover will reveal the microprocessor. You may upgrade the CPU for higher system performance.

Battery Pack

This compartment houses a rechargeable battery pack of either Ni-MH or Li-Ion. To recall detailed information turn back to the section *Battery Pack*.

CD-ROM Cover

The CD-ROM cover functions for easy installation and easy removal of the CD-ROM, in case you need maintenance service during warranty period.

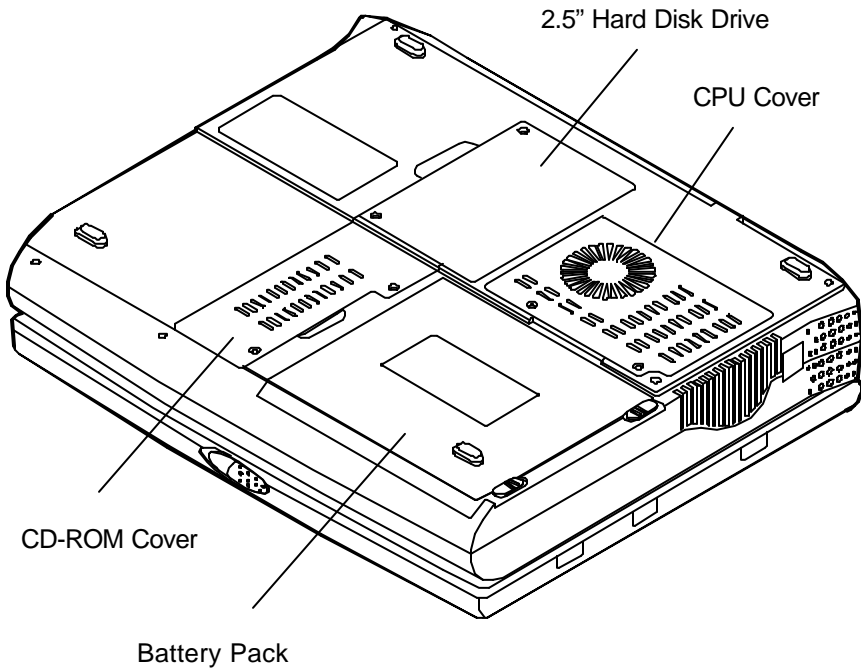













Figure 1-14

Chapter 2: Operation

The Notebook has many advanced features to help you with your computing work. This chapter describes each of the Notebook's hardware features and shows you how to use them.

Before you begin working with any internal components of the Notebook, remove the battery and disconnect the AC power adapter.

Make sure that you wear an anti-static wrist strap to ground yourself before working with any internal components of the Notebook. Static electricity may damage components beyond repair.

-  Upgrading CPU
-  Setting DIP Switches
-  Expanding Memory
-  Using Hard Disk Drive
-  Using Floppy Disk Drive
-  Using CD-ROM
-  Using PC Card Sockets
-  Using Hot Keys
-  Using Numeric Keypad
-  Getting Familiar with LCD Panel
-  Using Power Management
-  Attaching Peripheral Devices

Upgrading CPU

The system is capable of hosting a wide range of Intel Pentium and AMD K6 processors. Upgrading your CPU will increase your computing speed. The higher the CPU speed installed, the better the system performance. Different CPUs may have different power voltages. If you want to upgrade the CPU, remember to adjust the corresponding settings.

Replacing CPU

1. Remove all power sources (AC power and battery).
2. Turn the Notebook over.
3. Remove the CPU cover.
4. Remove the screws that fasten the heat sink mounted on the CPU (Figure 2-1).

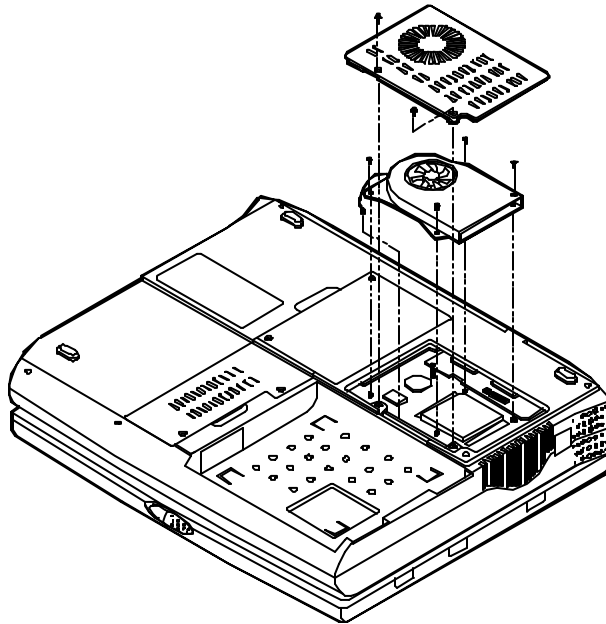

Figure 2-1

Note:

- Contact your dealer for the **proprietary tool** to replace the CPU.
- Wait for the CPU to cool down before replacing it.

Replacing the Hex Studs

You need to install the correct four hex studs to properly accommodate the height of the CPU just installed.

CPU	Color of Hex Studs
Intel Pentium Processor at 3.3V I/O Voltage	Black
Intel Pentium Processor at 2.5V I/O Voltage	Silver
AMD K6 Processor	Bronze

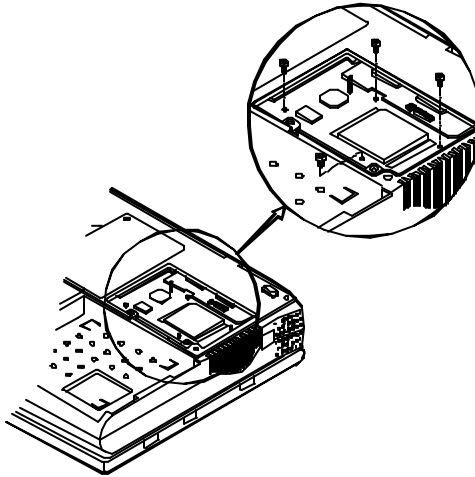

Reinstallation

Reinstall the CPU in the reverse order of removal. Make sure that the heat sink cable is properly installed.

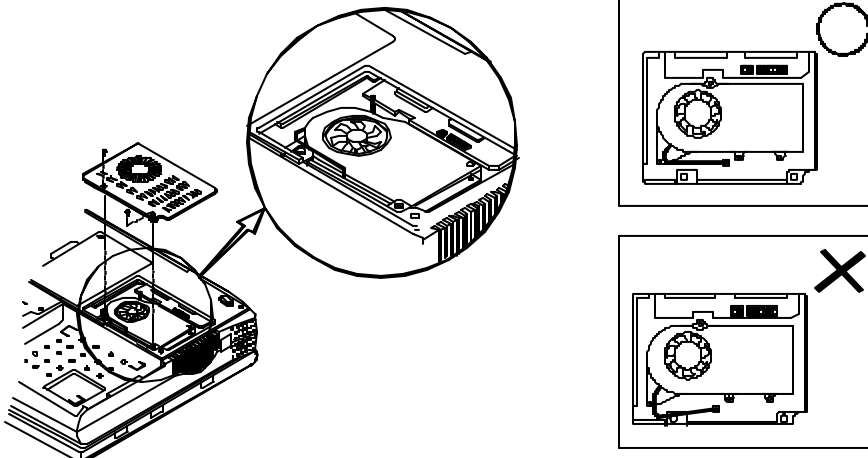

Setting DIP Switch

You need to set the following DIP Switches for correct system configuration:

- 10-pole DIP Switch for CPU core frequency (MHz) and flash ROM BIOS.
- 8-pole DIP Switch for CPU core voltage.
- 2-pole DIP Switch for CPU I/O voltage.

Accessing the 10-Pole DIP Switch

1. Turn the system power off.
2. Press the two keyboard latches so that the keyboard can be elevated from its normal position (Figure 2-2).
3. Carefully lift the keyboard assembly out so that the mainboard is exposed. Employ the 10-pole DIP Switch to set the configuration (Figure 2-3).

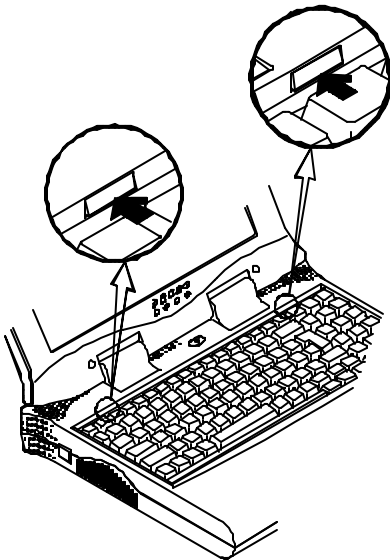

Figure 2-2

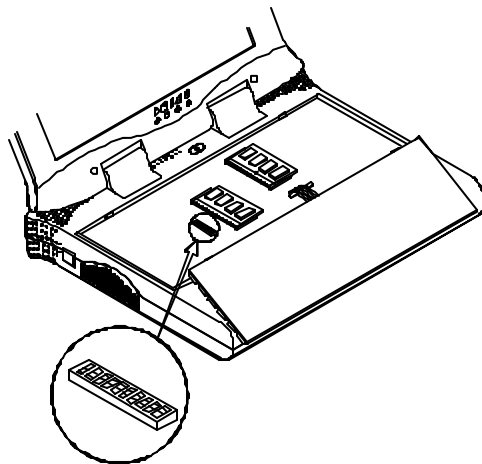

Figure 2-3

CPU Core Frequency Settings

The correct configuration for CPU core frequency is listed as follows:

Intel Pentium Processor at 3.3V I/O Voltage										
CPU Frequency	1	2	3	4	5	6	7	8	9	10
120 MHz	X	X	X	On	Off	On	Off	Off	Off	Off
133 MHz	X	X	X	Off	Off	On	Off	Off	Off	Off
150 MHz	X	X	X	On	Off	On	On	Off	Off	Off
166 MHz	X	X	X	Off	Off	On	On	Off	Off	Off
200 MHz	X	X	X	Off	Off	Off	On	Off	Off	Off
233 MHz	X	X	X	Off	Off	Off	Off	Off	Off	Off

* X = Not Applied.

Intel Pentium Processor at 2.5V I/O Voltage										
CPU Frequency	1	2	3	4	5	6	7	8	9	10
200 MHz	X	X	X	Off	Off	Off	On	On	Off	On
233 MHz	X	X	X	Off	Off	Off	Off	On	Off	On
266 MHz	X	X	X	Off	Off	On	On	Off	Off	On

* X = Not Applied.

AMD K6 Processor										
CPU Frequency	1	2	3	4	5	6	7	8	9	10
266 MHz	X	X	X	Off	Off	On	Off	On	Off	Off
300 MHz	X	X	X	Off	Off	On	On	On	Off	Off

* X = Not Applied.

Flash ROM BIOS Settings

In order to keep up with the latest system BIOS, your Notebook may be upgraded. Consult your dealer for further information. The DIP Switch needed to be set in the **On** position when updating the existing system BIOS. The DIP Switches should be reset to the **Off** position after BIOS updating is complete.

Flash ROM BIOS	1	2	3	4	5	6	7	8	9	10
Existing BIOS	Off	Off	X	X	X	X	X	X	X	X
Updating BIOS	On	On	X	X	X	X	X	X	X	X

* X = Not Applied.

Accessing the 8-Pole DIP Switch

Access the 8-pole DIP Switch to set the CPU core voltage.

1. Turn the system power off.
2. Turn the Notebook over.
3. Remove the CPU cover. Use the 8-pole DIP Switch to set the configuration (Figure 2-4).

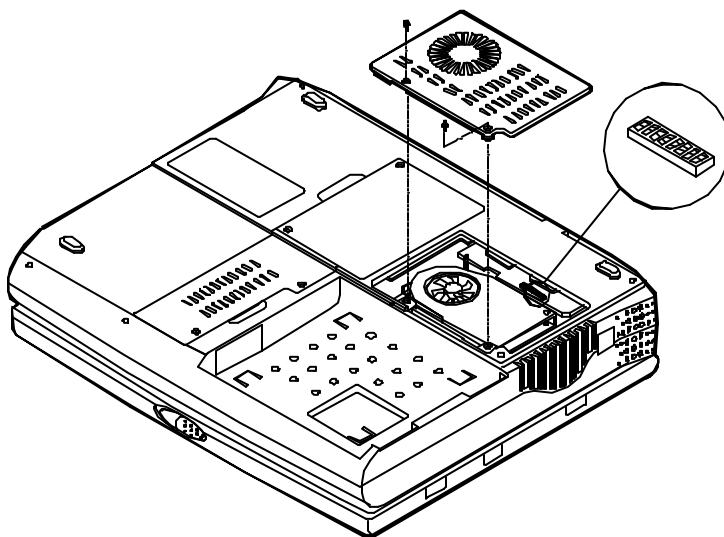

Figure 2-4

CPU Core Voltage Settings

The correct configuration for CPU core voltage is listed as follows:

CPU Core Voltage	1	2	3	4	5	6	7	8
1.8 V	On	Off	Off	Off	Off	Off	X	X
2.0 V	On	On	Off	Off	Off	Off	X	X
2.2 V	On	On	On	Off	Off	Off	X	X
2.45 V	On	On	On	On	Off	Off	X	X
2.8 V	On	On	On	On	On	Off	X	X
3.45 V	On	On	On	On	On	On	X	X

* X = Not Applied.

Accessing the 2-Pole DIP Switch

Access the 2-pole DIP Switch to set the CPU I/O voltage.

1. Turn the system power off.
2. Turn the Notebook over.
3. Remove the CPU cover. Use the 2-pole DIP Switch to set the configuration (Figure 2-5).

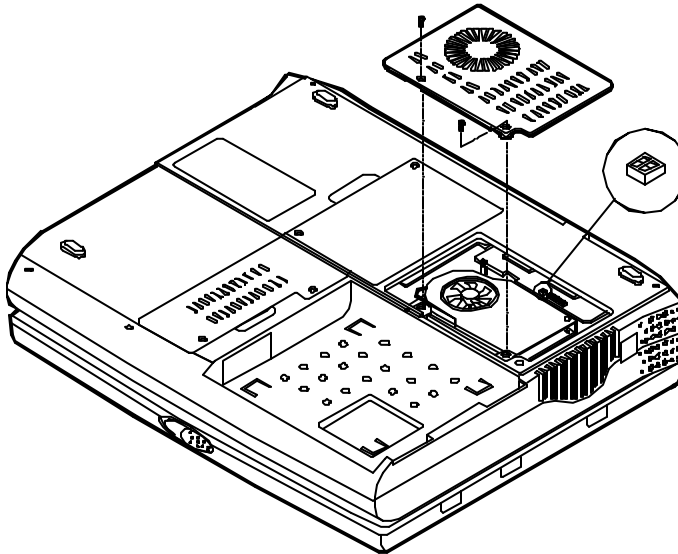

Figure 2-5

CPU I/O Voltage Settings

The correct configuration for CPU I/O voltage is listed as follows:

CPU I/O Voltage	1	2
2.5 V	On	Off
3.45 V	On	On

If what you install is Intel Pentium processor at 3.3V I/O voltage, please set the same as 3.45V.

Expanding Memory

The system has two memory sockets for different RAM modules to expand the memory up to 128MB. These RAM modules are of a 144-pin SODIMM (Small Outline Dual In-line Memory Module) type. The Notebook supports Fast Page Mode, EDO (Extended Data Out), and SDRAM operation. With the following memory configurations the total memory size will be automatically detected by the POST routines:

Bank 1 (64-bit)	Bank 2 (64-bit)	Power	Minimum Speed	Total Size
(1Mx16)x4	None	3.3V	FPG: 60ns EDO: 60ns SDRAM:75MHz	8MB
(1Mx16)x4	(1Mx16)x4			16MB
(1Mx16)x8	None			16MB
(1Mx16)x8	(1Mx16)x4			24MB
(4Mx16)x4	None			32MB
(1Mx16)x8	(1Mx16)x8			32MB
(4Mx16)x4	(4Mx16)x4			64MB
(4Mx16)x8	None			64MB
(8Mx8)x8	None			64MB
(4Mx16)x8	(1Mx16)x4			72MB
(4Mx16)x8	(1Mx16)x8			80MB
(4Mx16)x8	(4Mx16)x4			96MB
(4Mx16)x8	(4Mx16)x8			128MB
(8Mx8)x8	(8Mx8)x8			128MB

Accessing the Memory Sockets

1. Turn the system power off.
2. Press the two keyboard latches so that the keyboard can be elevated from its normal position (Figure 2-2).
3. Carefully lift the keyboard assembly out so that the mainboard is exposed. Locate the memory sockets (Figure 2-6).

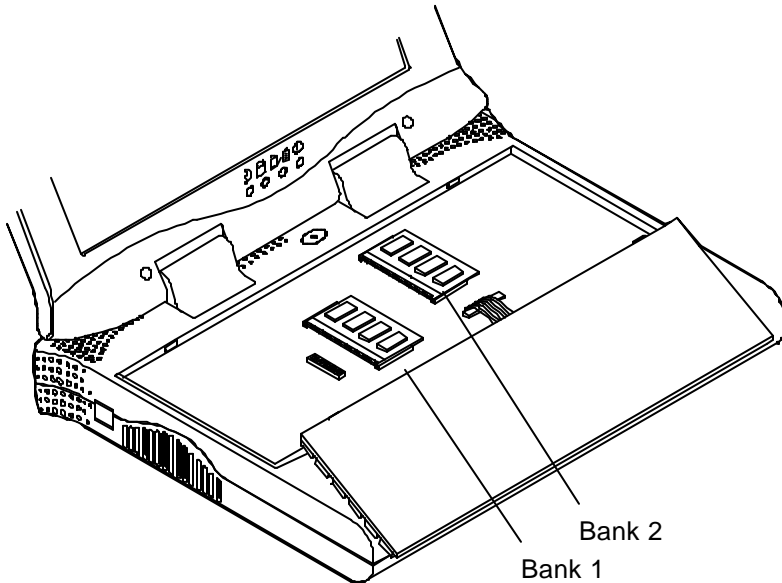

Figure 2-6

Installing Memory Module

Follow the steps below to install the memory module:

1. Turn the system power off.
2. Press the two keyboard latches so that the keyboard can be elevated from its normal position (Figure 2-2).
3. Carefully lift the keyboard assembly out so that the mainboard is exposed. Locate the memory sockets (Figure 2-6).
4. Position the memory module at a slight angle and fit its connectors into the socket firmly. Push the module down and ensure it locks into place (Figure 2-7).
5. Reinstall the keyboard assembly.

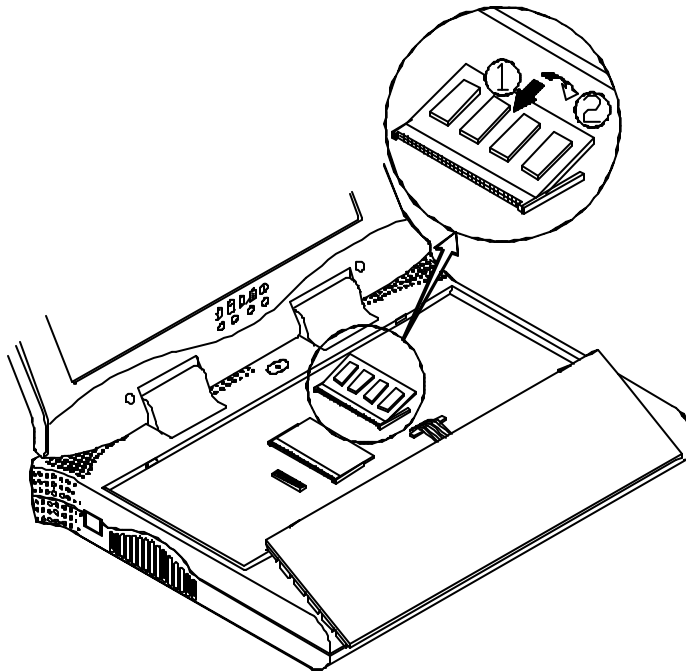

Figure 2-7

Removing Memory Module

1. Turn the system power off.
2. Press the two keyboard latches so that the keyboard can be elevated from its normal position (Figure 2-2).
3. Carefully lift the keyboard assembly out to expose the mainboard. Locate the memory sockets (Figure 2-6).
4. Gently pull the two latches on both ends of the module outward. The module will pop up (Figure 2-8).
5. Remove the memory module.
6. Reinstall the keyboard assembly.

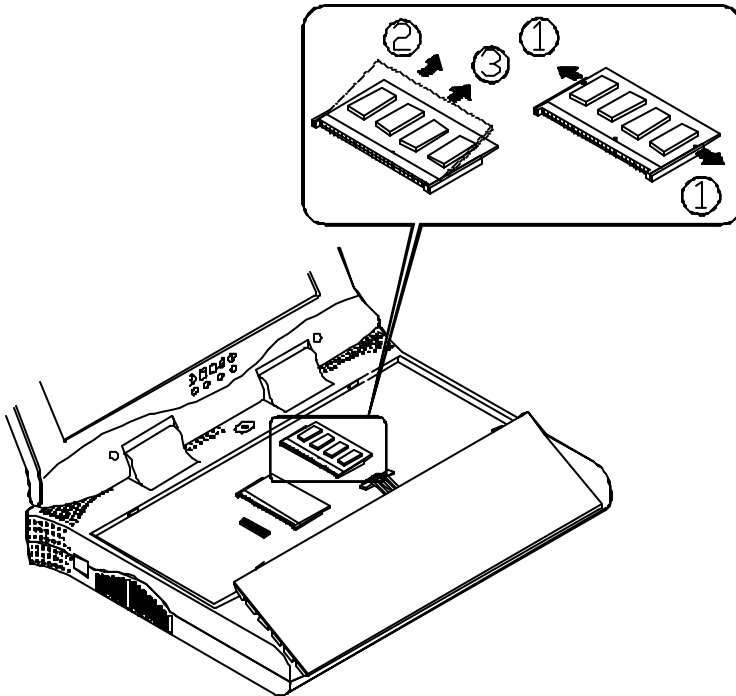

Figure 2-8

Using Hard Disk Drive

The hard disk drive is mounted in a removable case and may therefore be taken out to accommodate other 2.5" IDE hard disk drives with a height of 12.7mm. The system supports drives with capacities greater than 528MB through the Logical Block Addressing (LBA) mode. It also supports Programmed I/O (PIO) mode 4 and provides a high performance data transfer rate at speeds up to 33 MBytes/second (ATA-33).

Removing

1. Turn the system power off.
2. Turn the Notebook over.
3. Remove the HDD cover (Figure 2-9).
4. Disconnect the cable (Figure 2-9).
5. Detach the HDD case from the Notebook (Figure 2-9).

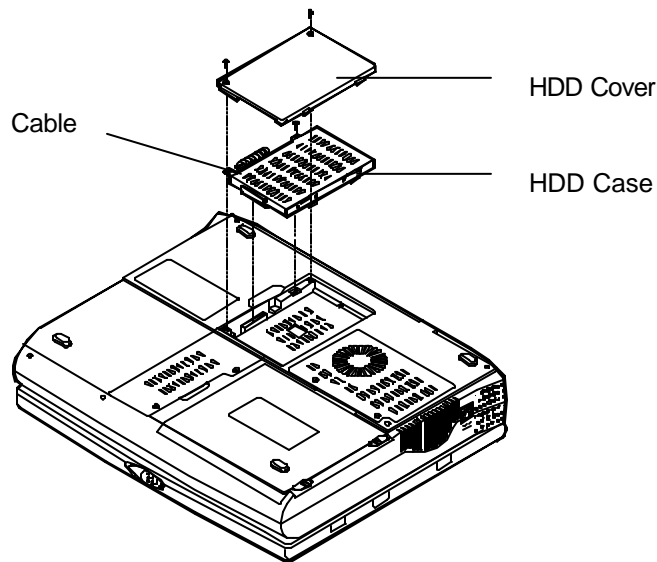

Figure 2-9

Inserting

Reinstall the Hard Disk Drive in the reverse order of removal.

Replacing Hard Disk Drive

The hard disk drive is contained within a case. Two screws on each side of the case need to be removed so that the hard disk drive can be taken out of the case to replace with another one (Figure 2-10). **The location of the two screws may be varied depending on different hard disk models.** Gently disconnect the cable from the hard disk drive when taking it out of the case. Be careful not to bend any pins or crimp the cable.

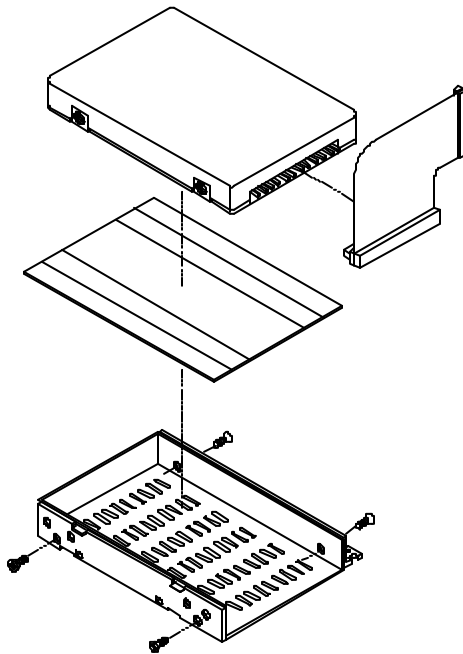

Figure 2-10

Using Floppy Disk Drive

The Notebook comes standard with a 1.44MB, 3.5" floppy disk drive. It is labeled drive A: and may be used as a boot device if properly set.

Inserting/Removing Diskettes

When using the floppy drive, always insert your floppy diskette label-side up (Figure 2-11). To remove your diskette, press the eject button on the top-right corner of the floppy drive.

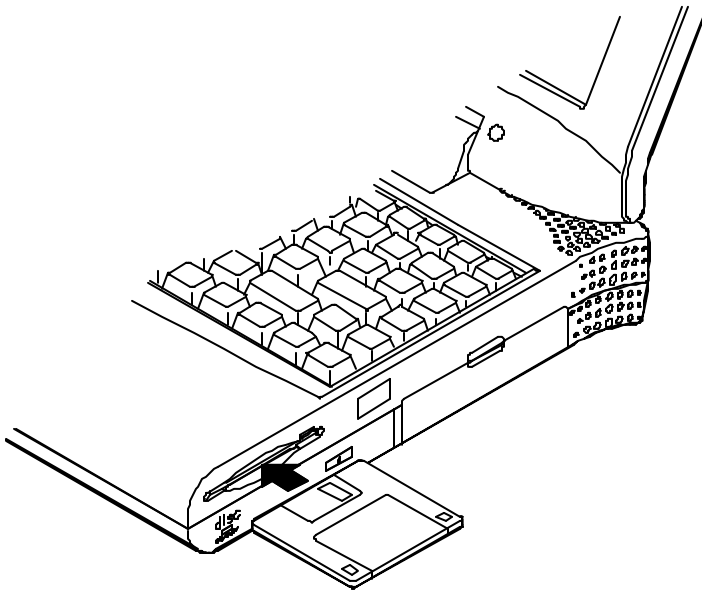

Figure 2-11

Write-Protecting Diskettes

Diskettes can be write-protected to prevent files from being accidentally erased or destroyed. To write-protect a 3.5" floppy diskette, move the built-in write-protect tab to the write-protect position, ("*up*" so that you can see through the "*hole*" in the upper, right-hand corner of the diskette). Putting the write protect tab back "*down*" will enable you to write data on the disk again.

Do's and Don'ts

- Always make backup copies of your software and data diskettes.
- Keep diskettes away from magnetic fields.
- Do not remove diskettes from the drive while the diskette "in-use" light is on.
- Do not open or remove the protective shutter which covers the diskette's media.
- Do not allow dust or moisture to collect on diskettes.
- Do not bend or throw diskettes.
- Do not clean diskettes with liquids or solvents.

Using CD-ROM

The Notebook comes standard with a removable 5.25" CD-ROM module. It is labeled drive D: and may be used as a boot device if properly set.

Do not disassemble the CD-ROM module. Only certified technicians should perform repairs to the CD-ROM module.

To insert a CD, press the **Eject Button** and place the CD on the **Disc Tray** label-side facing up. Push the CD tray in and you are ready to start. The **Busy Indicator** will light up while data is being accessed or while an audio CD is playing. When power to the system is unexpectedly interrupted, insert an instrument such as a straightened paper clip into the **Emergency Eject Hole** to manually eject the tray (Figure 2-12).

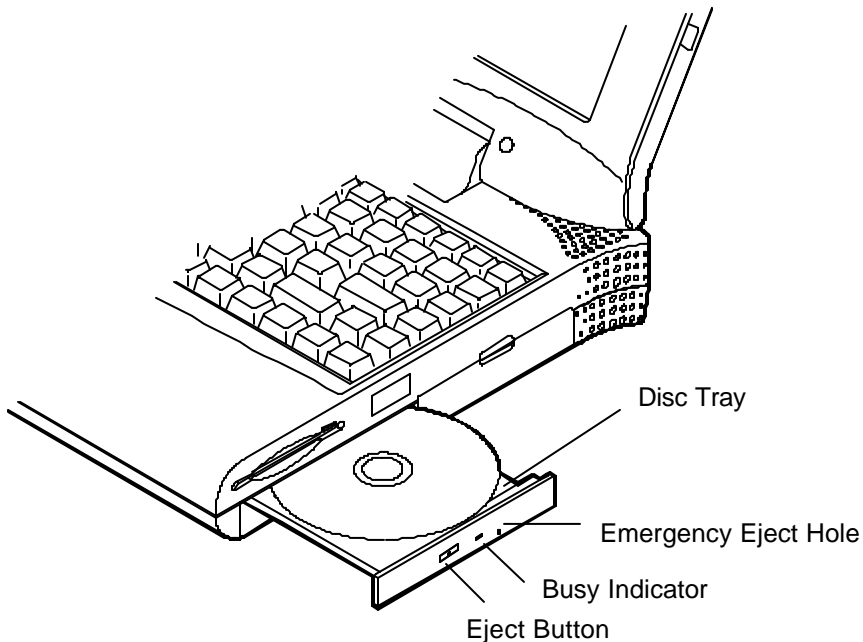

Figure 2-12

Removing CD-ROM Module

1. Turn the system power off.
2. Turn the Notebook over.
3. Remove the CD-ROM cover (Step 1 in Figure 2-13).
4. Remove the screw to release the CD-ROM module. (Step 2 in Figure 2-13).
5. Slide the CD-ROM module slightly out to disconnect the cable (Step 3 and Step 4 in Figure 2-13).
6. Pull gently and firmly the CD-ROM module away from the compartment (Step 5 in Figure 2-13).

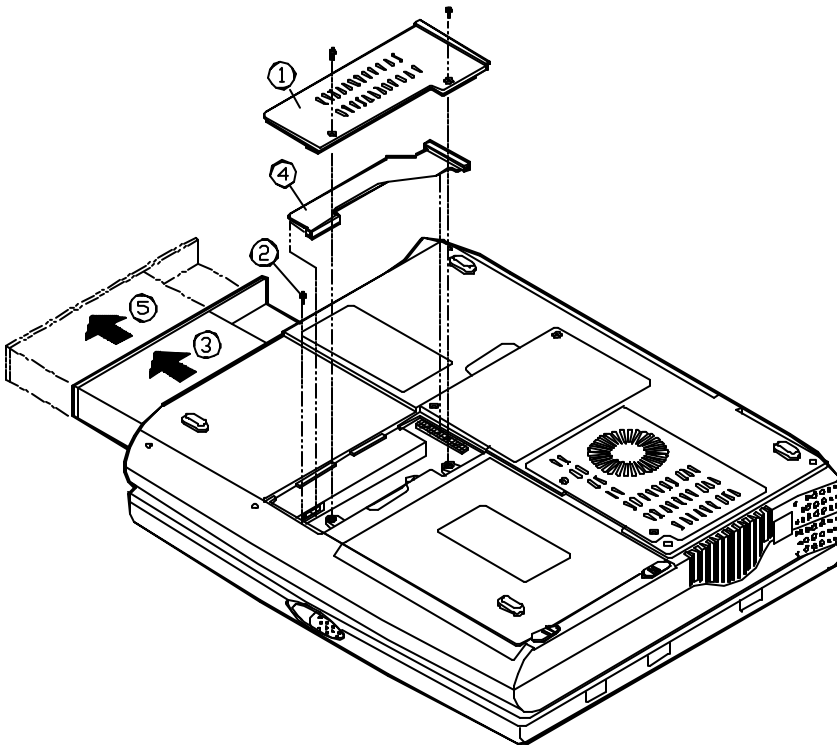

Figure 2-13

Loading Compact Discs

1. Turn on the power.
2. Press the CD-ROM eject button; the disc tray will pop out partially.
3. Pull the disc tray out.
4. Carefully load the CD on the disc tray with label-side facing up. Press it gently to ensure it fits into place (Figure 2-14).
5. Push the tray into the computer to close it.

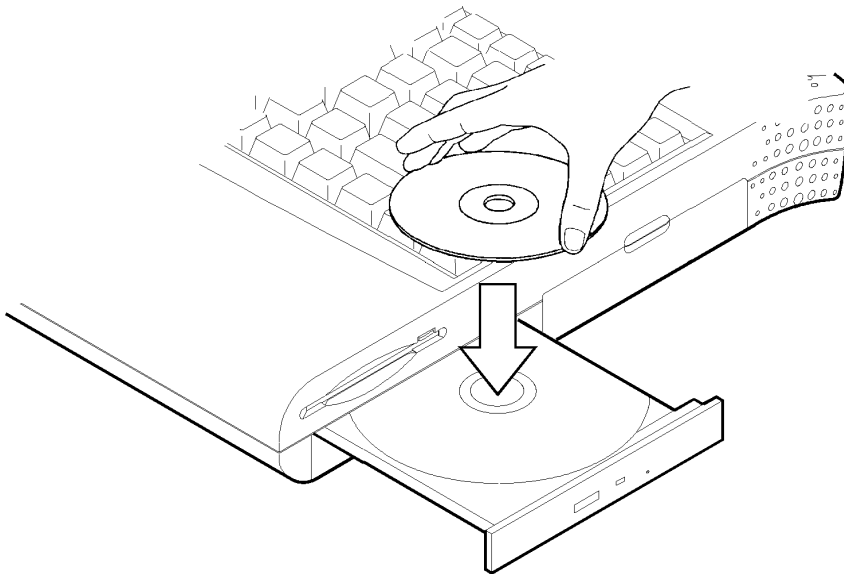

Figure 2-14

Handling of Compact Discs

Proper handling of your CDs will prevent them from being damaged and ensure the accessibility of data stored on them.

- Hold the CD by the edges; do not touch the surface of the disc.
- Use clean, soft, dry cloth to remove dust or fingerprints.
- Do not write on the surface using pen.
- Do not attach any paper or other materials to the surface of the disk.
- Do not store or place the CD in areas where it will be exposed to high temperatures.
- Do not use benzine, thinners, or other cleaners to clean the CD.
- Do not bend the Compact Disc.
- Do not drop or subject the CDs to shock.

Using PC Card Sockets

The Notebook provides system expansion capabilities with two PC card sockets (previously referred to as PCMCIA). PC cards to be inserted can be LAN, fax/modem, communication devices, or expanded memory. Both sockets support 3.3V 32-bit PC cards, referred to as **CardBus**. The CardBus sockets are backward compatible with 5V 16-bit PC cards. There are three types of PC cards. Type I measures 3.3mm thick; Type II 5.0mm; and Type III 10.5mm.

The PC card sockets accommodate one Type III card or two Type II cards and **the lower socket named Socket A is capable of ZV (Zoomed Video)**, which allows a direct connection between a PC card and video devices that enables high quality video playback.

Inserting PC Cards

1. Open the access door (Figure 2-15).
2. Align the PC card with the slot and push it in firmly until it locks into place (Figure 2-16).

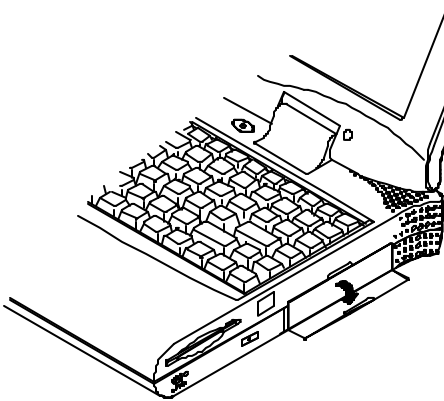

Figure 2-15

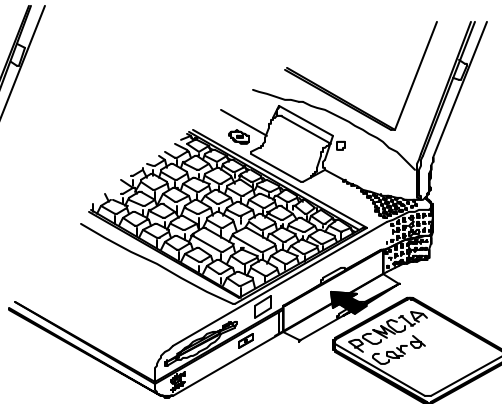

Figure 2-16

Removing PC Cards

To remove a PC card, press the appropriate eject button and the card will be ejected from its slot (please refer to Figure 2-17).

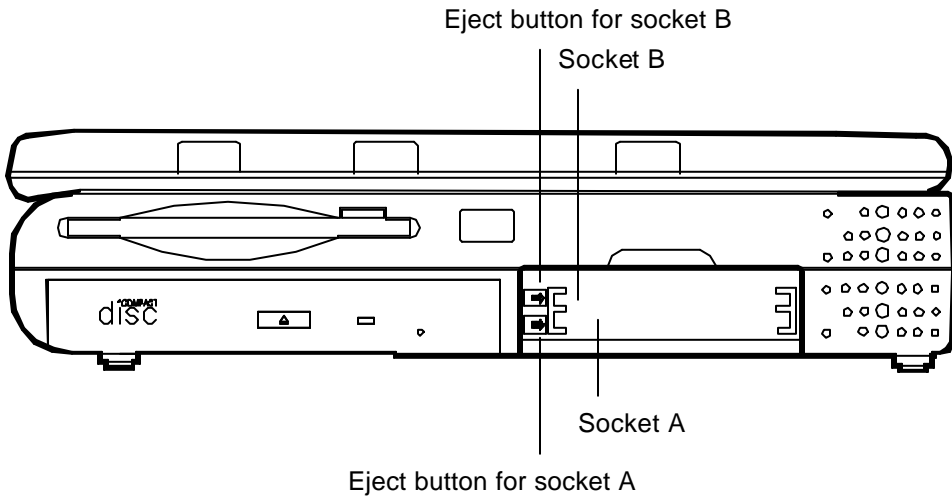























Figure 2-17

Using Hot Keys

Located on the bottom-left edge of the keyboard layout is a colored **Fn** key. It is a special feature found only on the Notebook that provides for key combinations with other keys for easy access to system features. Hold down the **Fn** key while pressing other key as below:

Hot Keys	System Features	Remark
 + 	Expand LCD display	
 + 	Control display top/center position	
 + 	Toggle LCD/CRT/LCD+CRT	
 + 	Decrease LCD contrast	Dual scan only
 + 	Increase LCD contrast	Dual scan only
 + 	Decrease LCD brightness	
 + 	Increase LCD brightness	
 + 	Decrease audio volume	
 + 	Increase audio volume	
 + 	Toggle audio mute on/off	
 + 	Put the system in a suspend state for power management	

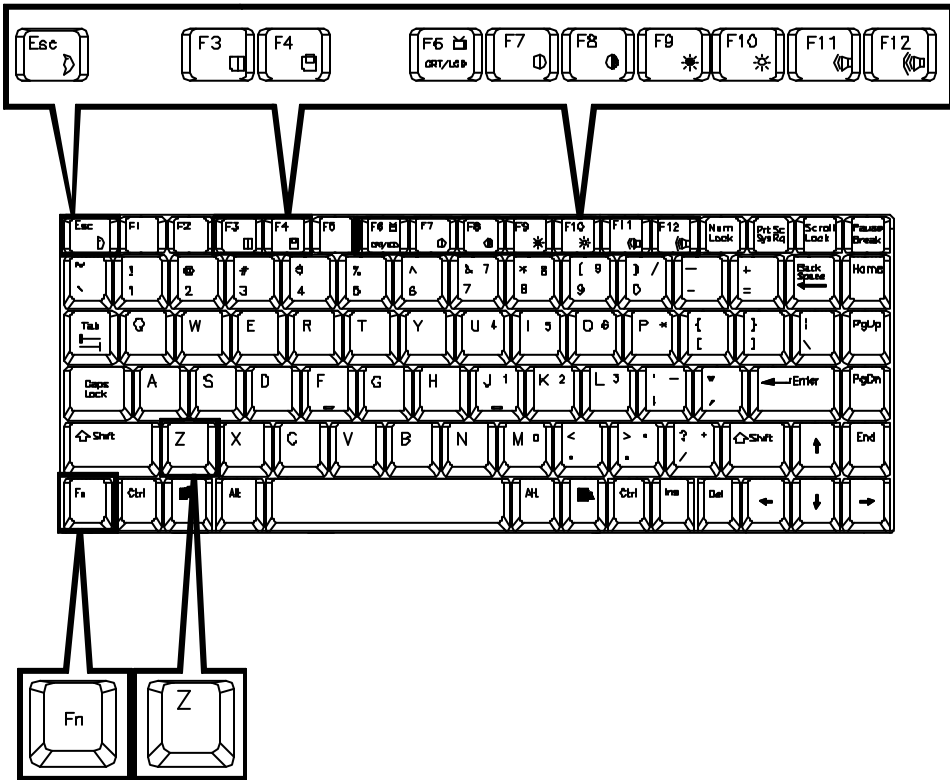

Figure 2-18

Using Numeric Keypad

The colored keys in the middle section of the keyboard will function as a Numeric Keypad (Figure 2-19). The numeric keypad overlay can be used for numeric data input. Follow these steps to access the Numeric Keypad:

1. Press the **NumLock** key to lock the Numeric Keypad.
2. Press the **Fn** key along with the colored keys to operate the Numeric Keypad.

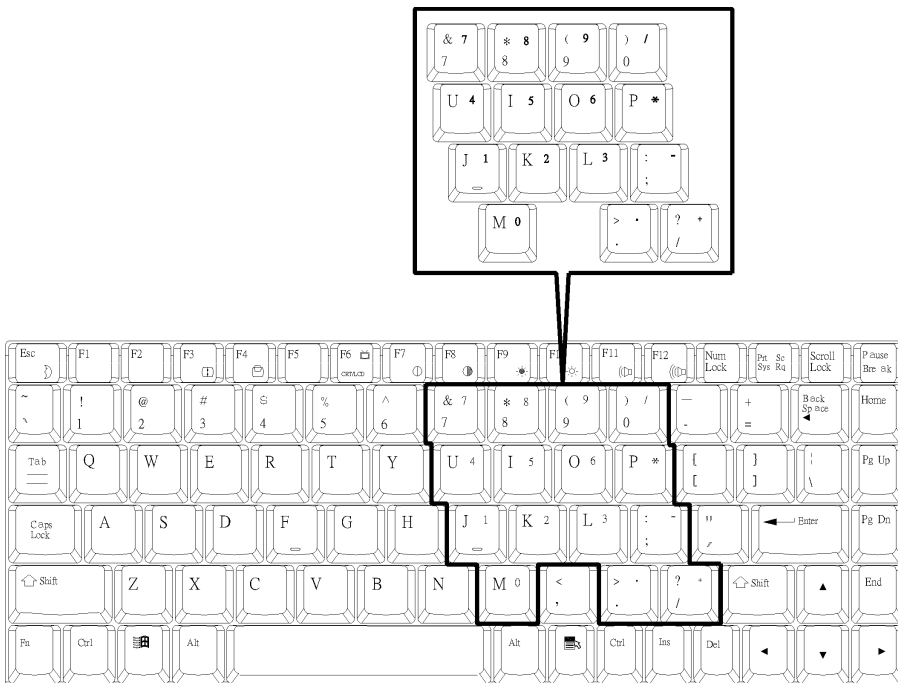
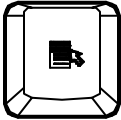

Figure 2-19

Windows 95 Special Keys

Application Key



The **Application key** has the same function as the secondary mouse button.

Windows Key



The **Window key** activates the *Start* menu.

LCD Panel

The Notebook Computer features the LCD panel display with the following:

- PCI local bus controller.
- 4MB video RAM (SGRAM type).
- Capability to support 1024x768 (XGA) resolution TFT display.
- Capability to support 800x600 (SVGA) resolution DSTN/TFT display.
- Ability to transmit video signals to a VGA monitor (CRT).
- Capable of simultaneous display on LCD and CRT.
- Video Port Manager (VPM) for video input from ZV-capable PC card.

Remark:

Two technologies of LCD display:

- Passive technology (DSTN = Dual-scan Super Twisted Nematic).
- Active technology (TFT = Thin Film Transistor).

Using Power Management

The Notebook system provides you with various modes to manage its power consumption while maintaining system performance. Please refer to *Chapter 3: BIOS Utilities, System Configuration Utility, Power Menu* for more information.

Advanced Power Management (APM 1.2)

The Notebook provides built-in Advanced Power Management (APM 1.2) support to reduce power consumption. APM function varies depending on the operating system you are using. **Some operating systems do not support APM, such as Windows NT, and therefore, cannot take advantage of the system's capabilities in this area.**

Advanced Configuration and Power Interface (ACPI)

The ACPI interface gives the operating system (OS) direct control over the power management and Plug and Play functions of a computer. The operating system can perform the functions covered by the ACPI specification, such as system power management, device power management, and thermal management.

Hard Disk Standby

The system will turn off the Notebook's hard disk drive motor if it has not been accessed after a specified period of time. The motor will be turned back on once the system attempts to read or write data to it.

Global Standby

In Global Standby mode, the CPU clock will be stopped and most controllable peripheral devices will be powered off. If the idle timer expires before any system activity is detected, the system will change from Standby mode into Suspend mode.

Suspend and Resume

When at extremely low power the system will halt operations yet retain all its programming. This is called **Suspend Mode**. The Suspend Mode features three levels: Powered-On-Suspend (POS) mode, Suspend-To-RAM (STR) mode, and Suspend-To-Disk (STD) mode.

Be sure not to initiate the Suspend Mode when any of the disk drives is accessed such as HDD, FDD and CD-ROM drive.

The system operation can be returned to exactly where it was suspended when wake-up event occur. This is called **Resume**.

Powered On Suspend (POS)

Of the three suspend modes, Powered-On-Suspend saves the least amount of power. However, it takes the shortest time to return to full operation.

Resume from POS Mode

The system may be resumed from Powered-On-Suspend mode by:

- Alarm resume (month/day/hour/minute)
- Modem ring
- Any keyboard key pressed

Suspend To RAM (STR)

Suspend-To-RAM mode is the medium level of system power management.

Resume from STR Mode

The system may be resumed from Suspend-To-RAM mode by:

- Alarm resume (month/day/hour/minute)
- Modem ring

Suspend To Disk (STD)

Suspend to Disk is a 0-volt suspend mode for system power management. STD mode saves the maximum power but takes the longest time to return to full operation.

1. Use your operating system's FDISK program to delete all partitions of the hard disk if any already exist on the target drive.
2. Boot the system from the A: drive and run the 0VMAKFIL.EXE Utility to create the Suspend to Disk partition on the hard disk of a size that will accommodate **the installed DRAM (n) plus 2MB integrated video RAM**.

A:|>0VMAKFIL /Pn

For example, if the system DRAM is 32MB, 0VMAKFIL will create a partition size of approximately 34MB.

A:|>0VMAKFIL /P32

Note: Rewrite the sector signatures if you need to partition the hard disk again.

C:|>0VMAKFIL /PW

3. Re-partition the hard disk using your operating system's FDISK program.

Resume from STD Mode

The system may be resumed from Suspend-To-Disk mode by:

- Power back on
- Alarm resume (month/day/hour/minute)

Attaching Peripheral Devices

The herein mentioned shows you how to attach peripheral devices to the ports or jacks on the rear panel of the Notebook Computer.

Attaching a Security Lock

To protect your Notebook from being stolen, the computer is equipped with a security connector. To install the security lock, wrap the cable around a desk or other immovable object, then insert the locking device into the connector (Figure 2-20).

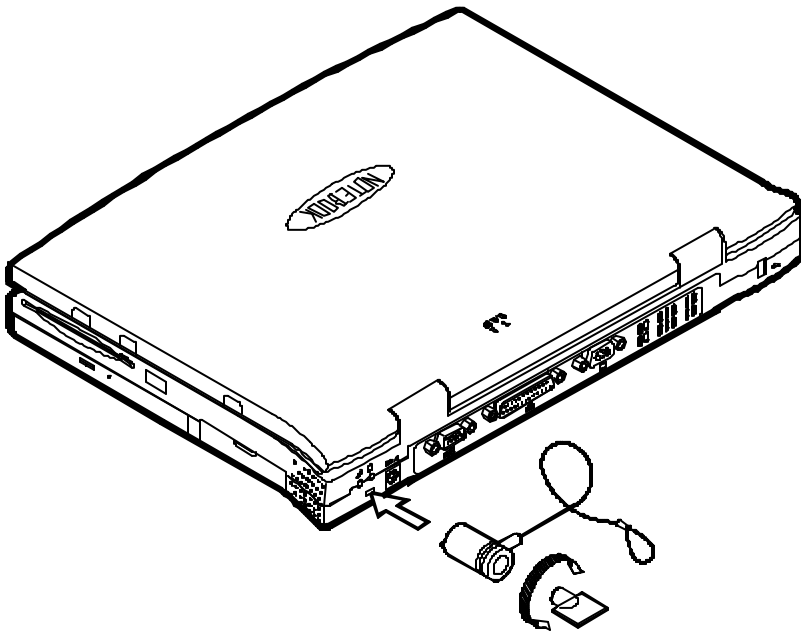

Figure 2-20

Attaching a PS/2 Keyboard or Mouse

The Notebook can be operated with a PS/2 keyboard or mouse attached by means of the PS/2 transfer cable. Attach the external keyboard or mouse as shown below (Figure 2-21).

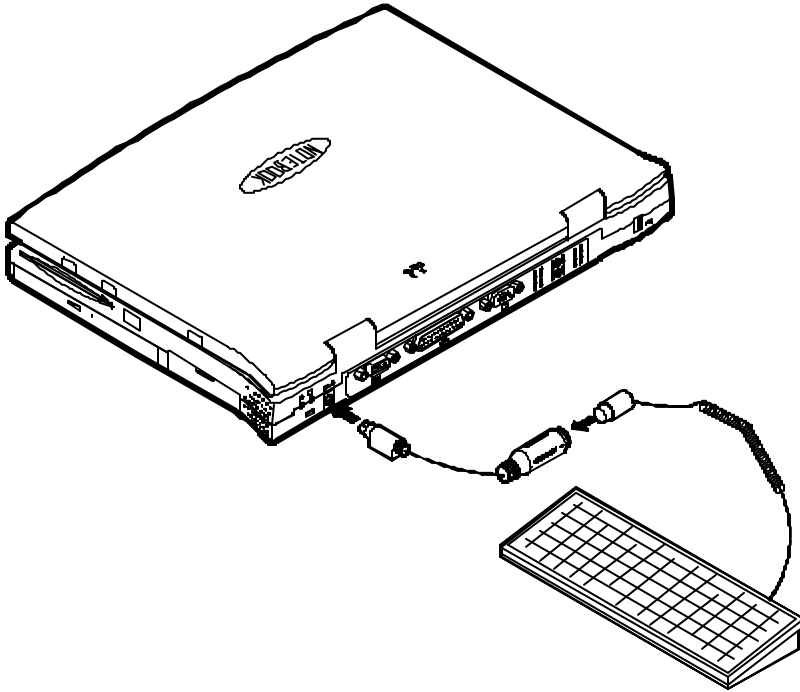

Figure 2-21

Attaching a Serial Mouse

The serial port features a 9-pin connector. You can connect any serial device such as a mouse to this port.

1. Turn the system power off.
2. Connect the cable to the serial port on the rear of the Notebook Computer (Step 1 in Figure 2-22).
3. Tighten the screws that fasten the cable to the serial port (Step 2 in Figure 2-22).
4. Turn on the Notebook Computer.

In addition, you may need to install the manufacturer-supplied driver for the serial mouse. Refer to the device's user's guide for more information.

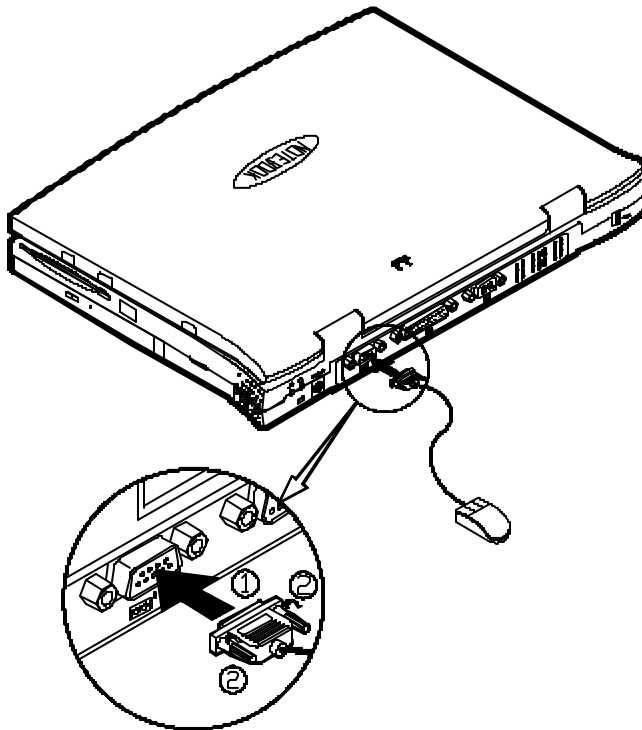

Figure 2-22

Attaching a Parallel Printer

You may connect any standard Centronics parallel printer to your Notebook using the parallel port.

1. Turn the system power off.
2. Connect the cable to the parallel port on the rear of the Notebook Computer (Step 1 in Figure 2-23).
3. Tighten the screws that fasten the cable to the parallel port (Step 2 in Figure 2-23).
4. Insert the other end of the cable to the printer's connector. Fasten the cable's connector.
5. Turn on the printer and Notebook Computer.

In addition, you will need to install the manufacturer-supplied driver for the printer. Refer to the device's user's guide for more information. If the connected printer supports EPP (Enhanced Parallel Port) or ECP (Extended Capabilities Port) mode, please enter System Configuration Utility (SCU) to configure the required setting.

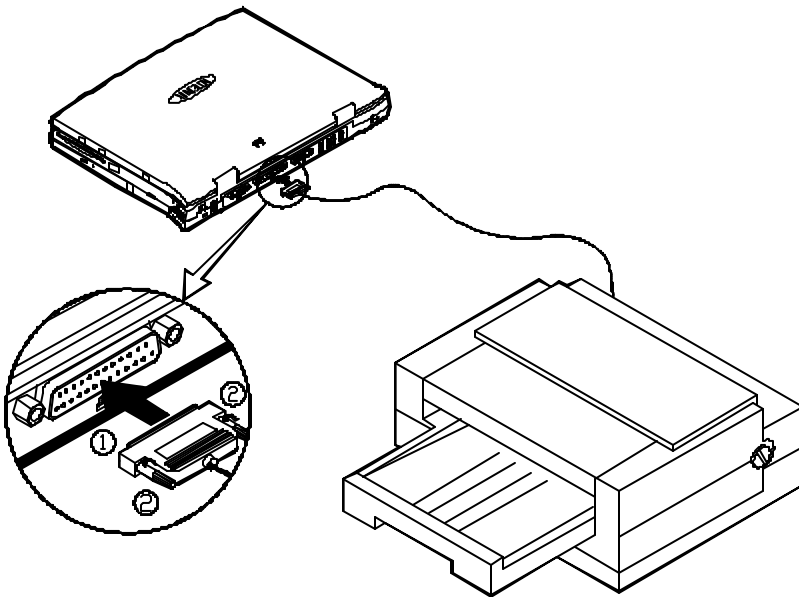

Figure 2-23

Attaching an External Monitor (CRT)

The computer is capable of displaying information not only on the LCD, but also on SVGA compatible displays attached to the computer. Information can be displayed on both the LCD and the external monitor simultaneously. Enter the System Configuration Utility (SCU) to select the appropriate parameters or use the **Fn + F6** keys (refer to *Chapter 2, Using Hot Keys*).

1. Turn the system power off.
2. Connect the cable to the CRT port on the rear of the Notebook Computer (Step 1 in Figure 2-24).
3. Tighten the screws that fasten the cable to the CRT port (Step 2 in Figure 2-24).
4. Insert the other end of the cable to the external monitor.
5. Turn on the Notebook Computer.

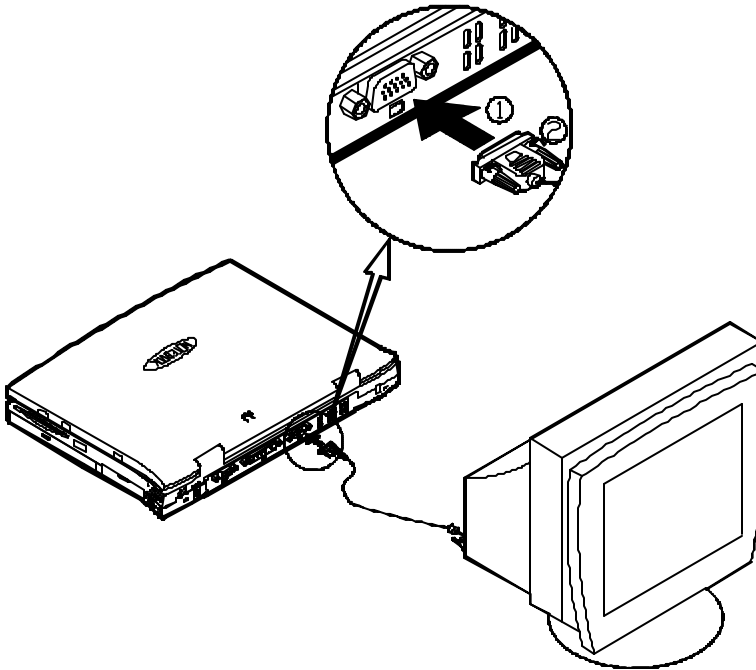

Figure 2-24

Attaching a USB-compatible Device

The Notebook provides a USB port for connection of a USB-compatible keyboard, mouse or other devices. Attach the device as shown below (Figure 2-25).

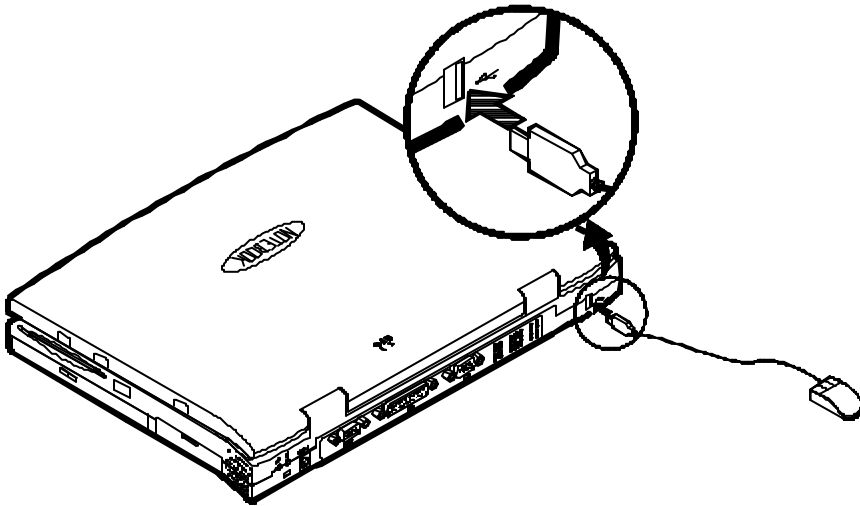





Figure 2-25

Chapter 3: BIOS Utilities

This chapter provides information regarding the Power On Self Test (POST) and shows you how to configure the system parameters using the System Configuration Utility (SCU).

-  Power On Self Test (POST)
-  Initiating the System Configuration Utility (SCU)
-  Specifying in the System Configuration Utility (SCU)

Power On Self Test (POST)

The system BIOS (Basic Input/Output System) performs a series of Power On Self Test (POST) on system memory and key computer components every time the computer is turned on. If an error exists, the POST routine may halt execution (depending on the severity of the problem). The POST also initializes BIOS configuration then boots the operating system.

POST Message: Normal Operation

If no error occurs, the system will be operating after the POST process is completed.

You may press the **Spacebar** key to skip the memory test.

SystemSoft MobilePRO BIOS Version 1.01 (2482-00)
Copyright 1983-1996 SystemSoft Corp. All Rights Reserved

233 MHz Pentium with MMX CPU
External Cache: 512KB installed
2 MB Video RAM
SystemSoft Plug-n-Play BIOS Ver.1.17.01

Base Memory	000640 Kb
Extended Memory	064512 Kb
Total Memory	065536 Kb

Auto Detecting IDE Devices[Done]

<CTRL-ALT-S> to enter System Configuration Utility

POST Message: Error Detected

If an error is detected, a WARNING message will be displayed. You should either press **F1** key to continue, or press the **Ctrl-Alt-S** keys simultaneously to enter the System Configuration Utility.

SystemSoft MobilePRO BIOS Version 1.01 (2482-00)
Copyright 1983-1996 SystemSoft Corp. All Rights Reserved

233 MHz Pentium with MMX CPU
External Cache: 512KB installed
2 MB Video RAM
SystemSoft Plug-n-Play BIOS Ver.1.17.01

Base Memory	000640 Kb
Extended Memory	064512 Kb
Total Memory	065536 Kb

WARNING – HARD DISK CONTROLLER 1 FAILURE
Auto Detecting IDE Devices[Done]

<CTRL-ALT-S> to enter System Configuration Utility
Press F1 to Continue

System Configuration Utility

The System Configuration Utility (SCU) is a ROM-based configuration utility that displays the system's configuration status and provides users with a tool to set their system parameters. The settings are stored in non-volatile battery-backed CMOS RAM which saves the information even when the power is turned off, and retains it when the system is turned back on.

Information in the System Configuration Utility

The following shows the system settings that may be changed within the System Configuration Utility.

Menu Bar Items	Pull-down Menu Items
Startup	Date and Time, Fast Boot, Boot Device, Display, Enable Battery Low Beep, Enable LCD Expand Mode, Boot Password, SCU Password.
Memory	Cache Systems.
Disks	Diskette Drives, IDE Settings.
Components	COM Ports, LPT Port, PS/2 Mouse Port, Keyboard Numlock, Keyboard Repeat, Enable Sound System, Audio Device.
Power	Enable Power Saving, Low Power Saving, Medium Power Saving, High Power Saving, Customize, Suspend Controls, Resume Timer, Enable MODEM Ring Resume, Enable Battery Low Suspend, Advance CPU Controls.
Exit	Save and Exit, Exit (No Save), Default Settings, Restore Settings, Version Info.

Initiating the System Configuration Utility

The System Configuration Utility (SCU) will be accessed when simultaneously pressing the **Ctrl**, **Alt**, and **S** keys.

<CTRL-ALT-S> to enter System Configuration Utility

The above message only lasts seconds. If you miss it, the computer will initiate the boot process. You must reboot the system and try again within the time limit if you want to enter the System Configuration Utility.

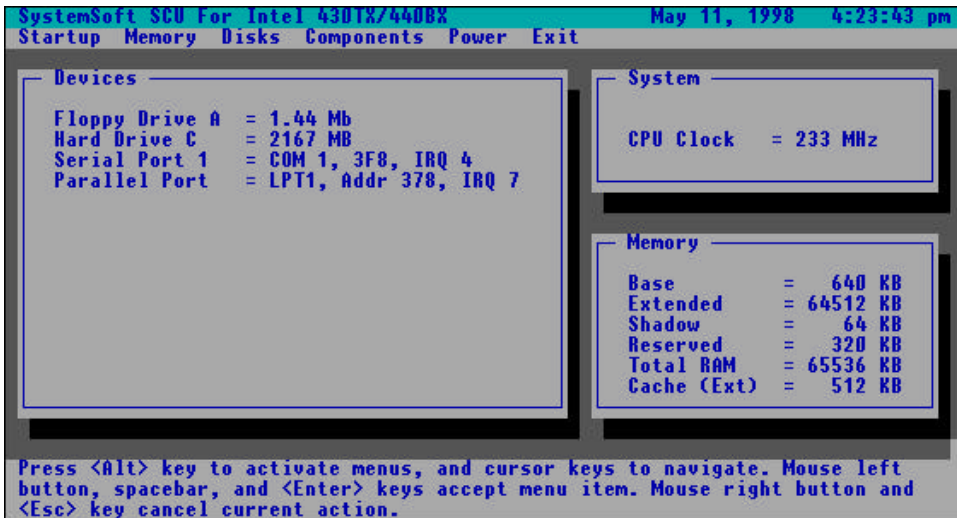

Figure 3-1
System Configuration Utility (SCU)

Working with the Menu Bar of the System Configuration Utility

Press **Ctrl-Alt-S** keys simultaneously to enter the menu bar of the System Configuration Utility.

Action	Keys Used	Description
Activate menus	Alt	Activate the System Configuration Utility.
Select menu bar item	Left arrow (←)	Move to a menu bar item on the left.
	Right arrow (→)	Move to a menu bar item on the right.
	The highlighted letter key	Move to the corresponding menu bar item.
Accept menu bar item	Mouse left button Spacebar Enter	Enter the selected menu bar item to configure settings.
Cancel current action	Mouse right button Esc	Undo the current command.

Working with the Pull-down Menu of the System Configuration Utility

When the desired menu bar item is highlighted, press the **Enter** key to enter the pull-down menu for values setting.

Action	Keys Used	Description
Select pull-down menu item	Down arrow (↓)	Move to the next pull-down menu item.
	Up arrow (↑)	Move to the previous pull-down menu item.
	The highlighted letter key	Move to the corresponding pull-down menu item.
Select a control	Tab	Move between the options.
Change values	Down/Up arrows (↓)(↑)	Modify the settings.
Accept entries	Spacebar	Enable/disable the specified function. When a check mark (√) appears, the function is on.
	Enter	Choose <OK> from a list of options.
Reject entries	Esc	Undo the current setting.
	Enter	Choose <Cancel> from a list of options.
Activate accelerators	Alt	Initiate all the highlighted letters corresponding to their respective options.
Quit	Esc	Press the Esc key to close the pull-down menu.

Features of the System Configuration Utility

Startup Menu

Item	Setting/Option	Function	
Date and Time	Day/Month/Year Hour/Minute/Second	Set the current date and time.	
Fast Boot	Enable	Initialize and quickly boot the system in a few seconds by skipping certain diagnostic tests.	
	Disable	Disable the above.	
Boot Device	1 st Boot device	Hard Disk C	Specify where the system boots from.
		CD-ROM Drive	
		Diskette A	
	2 nd Boot Device	Hard Disk C	Specify where the system boots from.
		CD-ROM Drive	
		Diskette A	
	3 rd Boot Device	Hard Disk C	Specify where the system boots from.
		CD-ROM Drive	
		Diskette A	
Display	CRT	Activate an external monitor.	
	LCD	Activate the system's LCD panel.	
	LCD+CRT	Activate both the LCD and the CRT.	
Enable Battery Low Beep	Enable	The system emits a series of warning beeps sound when the battery power becomes low.	
	Disable	Disable the above.	
Enable LCD Expand Mode	Enable	Stretch the display to fill the entire viewing area of the LCD panel.	
	Disable	Disable the above.	

Item	Setting/Option	Function
Boot Password	Enter old Power-On Password	Set password for booting computer. Users are authorized to start the system after entering correct password.
	Enter new Power-On Password	
	Verify new Power-On Password	
	Enable Password to Power-On	
SCU Password	Enter old Setup Password	Set password for modifying SCU. Users are authorized to change the SCU setting after entering correct password.
	Enter new Setup Password	
	Verify new Setup Password	
	Enable Setup Password	

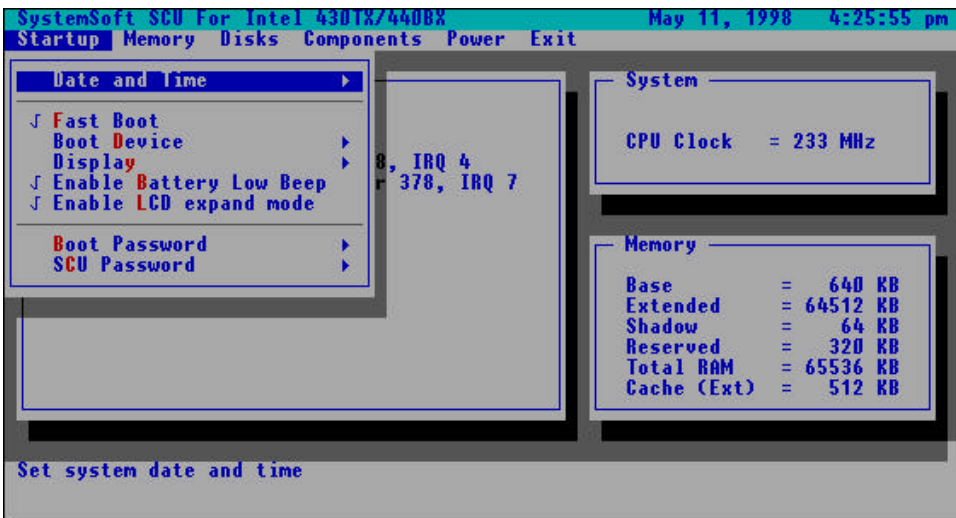

Figure 3-2
Startup Menu

Memory Menu

Item	Setting/Option		Function
Cache Systems	L1 Cache	Disabled	Disable the processor's internal cache.
		Write Back	Enable the processor's internal write-back cache.
	L2 Cache	Disabled	Disable the L2 cache controller.
		Write Back	Enable the L2 write-back cache.
	BIOS Shadow	Cached	The process of <i>shadowing</i> copies instructions from system BIOS into RAM to improve system performance.
		Not Cached	Disable the above.
Video Shadow	Cached	The process of <i>shadowing</i> copies instructions from video BIOS into RAM to improve system performance.	
	Not Cached	Disable the above.	

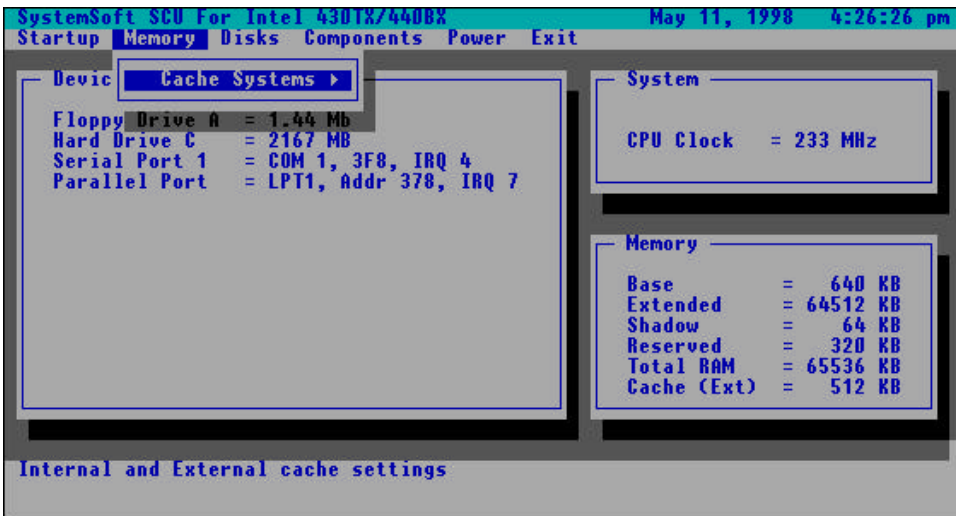

Figure 3-3
Memory Menu

Disks Menu

Item	Setting/Option	Function	
Diskette Drives	Drive A	None	Specify the drive types for the diskette drive A.
		1.44 MB	
		2.88 MB	
IDE Settings	Primary HDD	Drive Enabled	Enable enhanced IDE settings.
		PIO Mode	
	CD-ROM	Drive Enabled	
		PIO Mode	

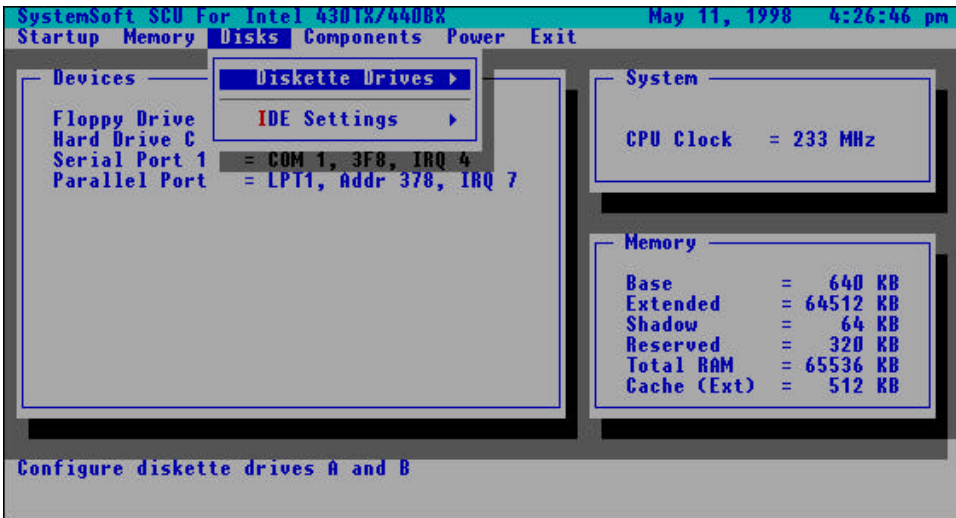

Figure 3-4
Disks Menu

Components Menu

Item	Setting/Option		Function
COM Ports	COM A I/O Settings	None	Specify the COM A port, I/O address, and IRQ signal.
		COM1, 3F8, IRQ4	
		COM2, 2F8, IRQ3	
		COM3, 3E8, IRQ4	
		COM4, 2E8, IRQ3	
LPT Port	Port Address	None	Specify the LPT port, I/O address, and IRQ signal.
		LPT1, Addr 378h, IRQ7	
		LPT2, Addr 278h, IRQ5	
		LPT3, Addr 3BCh, IRQ7	
	Port Definition	Standard AT (Centronics)	Specify the LPT port transmission mode. The EPP and ECP modes work only with EPP and ECP aware peripheral devices.
		Bidirectional (PS-2)	
		Enhanced Parallel (EPP)	
		Extended Capabilities (ECP)	
	DMA Setting For ECP Mode	DMA 1	Specify the ECP DMA channel.
		DMA 3	
	EPP Type	EPP 1.7	Specify the EPP mode version.
EPP 1.9			
PS/2 Mouse Port	Enable	Enable the system's pointing device or an external PS/2 mouse.	
	Disable	Disable the built-in pointing device or PS/2 mouse if an external mouse is connected to COM A port.	

Item	Setting/Option		Function
Keyboard Numlock	Enable		Specify if Num Lock is on or off at system boot time.
	Disable		
Keyboard Repeat	Key Repeat Rate	2 cps	Define the rate (characters per second) at which the keyboard repeats while a key is depressed.
		6 cps	
		10 cps	
		15 cps	
		20 cps	
	Key Delay	30 cps	Specify the amount of time (second) that will pass after a key is depressed before the key starts to repeat.
		¼ sec	
		½sec	
¾sec			
1 sec			
Enable Sound System	Enable		Enable the system's sound system.
	Disable		Disable the above.
Audio Device	Audio Port Addresses	At 220h-22Fh	Specify the audio port address.
		At 240h-24Fh	
		At 260h-26Fh	
		At 280h-28Fh	
	FM Alias Port	At 388h-38Bh	Specify the FM port address.
		At 408h-40Bh	
		At 488h-48Bh	
		At 508h-50Bh	
	Audio IRQ	IRQ 5	Specify the audio IRQ signal.
		IRQ 7	
		IRQ 9	
		IRQ 10	
	Playback DMA	DMA 0	Specify the DMA channels for audio playback.
DMA 1			
DMA 3			
Record DMA	DMA 0	Specify the DMA channels for audio recording.	
	DMA 1		
	DMA 3		

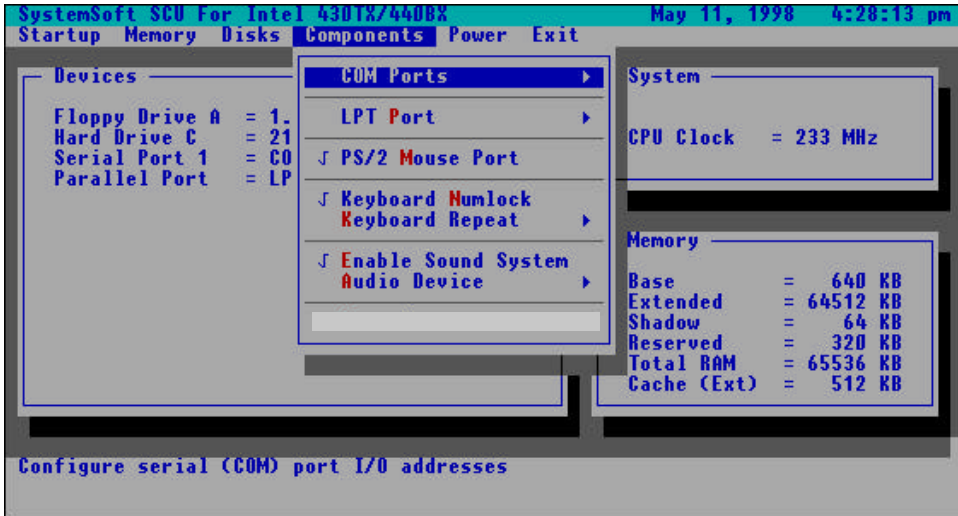

Figure 3-5
Components Menu

Power Menu

Item	Setting/Option		Function
Enable Power Saving	Enable		Enable/Disable all power saving features.
	Disable		
Low Power Saving	Enable		Enable/Disable the power saving to its lowest which results in max. performance but shortest battery life.
	Disable		
Medium Power Saving	Enable		Enable/Disable the power saving to its medium which results in both moderate performance and battery life.
	Disable		
High Power Saving	Enable		Enable/Disable the power saving to its highest which results in min. performance but longest battery life.
	Disable		
Customize	Disk Standby	Always on	The hard disk will be put on standby if it is not accessed within the specified period. Hard disk power will be restored when the disk drive is accessed again.
		30 sec	
		1 min	
		3 min	
		10 min	
	Global Standby	Always on	The system power will be reduced if the system has been idle for the specified period. System power will be restored when any system activity is detected.
		1 min	
		2 min	
		4 min	
		6 min	
		8 min	
		12 min	
	16 min		

Item	Setting/Option		Function
Suspend Controls	Suspend Type	Suspend To Disk	Specify the suspend mode for power management.
		Suspend To RAM	
		Powered On Suspend	
	Suspend Timeout	Never	If the system has been idle for the specified period, the system will enter user-defined suspend.
		1 min	
		5 min	
10 min			
20 min			
Resume Timer	Alarm Resume	Enable	Resume the system from the configured suspend mode when resume alarm timer expires.
		Disable	
	Resume Month/Day/Hour/Minute	The system will resume at the specified time (month, day, hour and minute).	
Enable MODEM Ring Resume	Enable		Resume the system from STR or POS mode when a modem ring is detected from the serial port.
	Disable		Disable the above.
Enable Battery Low Suspend	Enable		Automatically suspend the system upon a low battery condition.
	Disable		Disable the above.
Advance CPU Controls	Clock Control Mechanism	Full Speed	Specify the type of Processor Clock Control.
		Doze Mode	

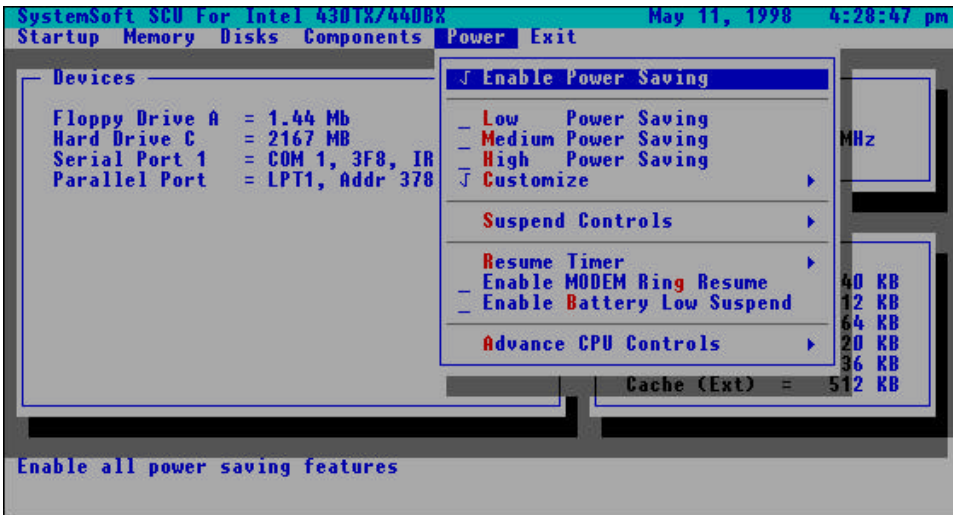

Figure 3-6
Power Menu

Exit Menu

Item	Function
Save and Exit	Save the current settings and reboot the system.
Exit (No Save)	Exit without saving any current changes.
Default Settings	Restore the default settings (the original ones found in ROM).
Restore Settings	Restore the current setup settings to the original custom ones.
Version Info	Show current BIOS version information.

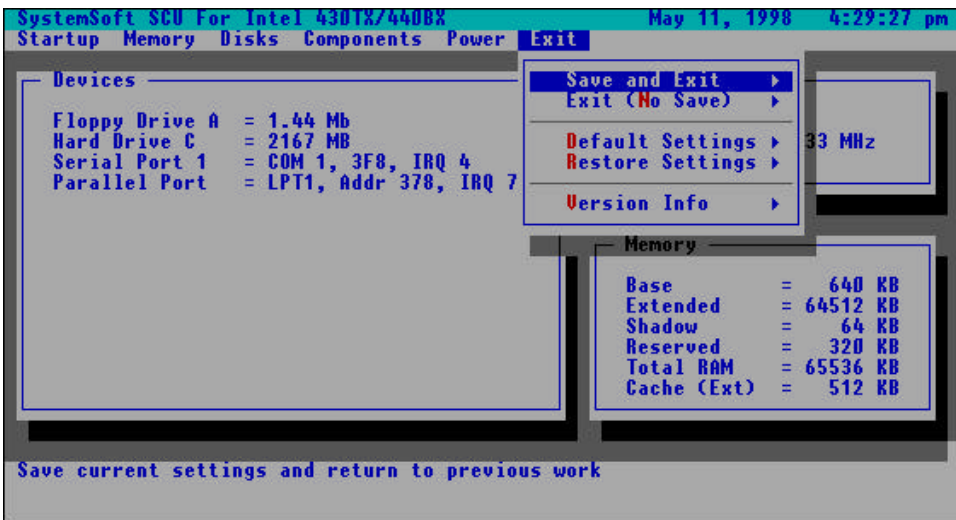

Figure 3-7
Exit Menu

Appendix A: Specifications

This appendix describes the features and specifications for the Notebook Computer.

CPU

- Intel Pentium Processors with MMX technology.
- AMD K6 Processors.

Memory

- 3.3V power supply.
- Supports Fast Page Mode/EDO/SDRAM.
- 512KB secondary cache Pipeline Burst Synchronous RAM (PBSRAM).
- 8MB expandable up to 128MB.
- 144-pin SODIMM package.

System BIOS

- 256KB flash ROM.
- PCI 2.1.
- Plug and Play 1.0a.

Display

- 14.1" TFT XGA (1024x768 pixels) LCD panel available.
- 13.3" TFT XGA (1024x768 pixels) LCD panel available.
- 12.1" DSTN/TFT SVGA (800x600 pixels) LCD panel available.
- 4MB display memory (SGRAM).
- Video Port Manager (VPM 1.10) for Zoomed Video (ZV) port.
- Simultaneous display with an external monitor.

Mass Storage

- 3.5" floppy diskette drive.
- 2.5" hard disk drive (12.7mm high or less).
- 5.25" CD-ROM.

 **Audio**

- Sound Blaster Pro compatible.
- Full duplex operation.
- 3D stereo sound effects.
- Built-in microphone.
- Built-in speakers.

 **PC Card Sockets**

- One Type III PC card or two Type II PC cards.
- CardBus support.
- One socket ZV-capable.

 **Input/Output**

- Built-in pointing device (PS/2).
- USB port.
- External monitor (CRT) port.
- Parallel port.
- Serial port.
- PS/2 type port.
- Microphone-in jack.
- Headphone jack.

 **Infrared Wireless Communication**

- IrDA (HPSIR)
- ASKIR

 **Keyboard**

- Windows 95.
- Detachable for various language versions.

 **Power Management**

- APM 1.2.
- ACPI.
- Global standby.
- Suspend and resume.

 **Rechargeable Battery Pack**

- Ni-MH battery available.
- Li-Ion battery available.
- Battery low warning.
- Auto-switching with AC power adapter.

 **Size & Weight**

- 302mm(w)x249mm(d)x46mm(h).
- 3kg.

 **Temperature Environment**

- Operating 5°C~35°C
- Storage -20°C~60°C

 **Humidity Environment**

- Operating 20%~80%, non-condensing
- Storage 10%~90%, non-condensing

Appendix B: I/O Port Pin Assignments

Parallel Port

Pin	Signal	Pin	Signal
1	Strobe#	14	Auto Linefeed#
2	Data 0	15	Error#
3	Data 1	16	Initialize#
4	Data 2	17	Select In
5	Data 3	18	GND
6	Data 4	19	GND
7	Data 5	20	GND
8	Data 6	21	GND
9	Data 7	22	GND
10	ACK#	23	GND
11	Busy	24	GND
12	Paper Empty	25	GND
13	Select		

Serial Port

Pin	Signal
1	DCD (Data Carrier Detect)
2	RXD (Received Data)
3	TXD (Transmitted Data)
4	DTR (Data Terminal Ready)
5	GND (Signal Ground)
6	DSR (Data Set Ready)
7	RTS (Request To Send)
8	CTS (Clear To Send)
9	RI (Ring Indicator)

Monitor Port

Pin	Signal	Pin	Signal	Pin	Signal
1	RED	6	GND	11	N.C
2	GREEN	7	GND	12	DDCDATA
3	BLUE	8	GND	13	HSYNC
4	N.C	9	N.C	14	VSYNC
5	GND	10	GND	15	DDCCLK

PS/2 Type Port

Pin	Signal
1	EKDA
2	EMDA
3	GND
4	VCC
5	EKCLK
6	EMCLK

USB Port

Pin	Signal
1	V1+OUT
2	VD1-N
3	VD1-P
4	GND

PC Card Sockets

Socket A:

Pin	Signal	Pin	Signal
1	GND	35	GND
2	A-CD3	36	A-CD1#
3	A-CD4	37	A-CD11
4	A-CD5	38	A-CD12
5	A-CD6	39	A-CD13
6	A-CD7	40	A-CD14
7	A-CE1#	41	A-CD15
8	A-CA10	42	A-CE2#
9	A-0E#	43	A-VS1
10	A-CA11	44	A-IORD#
11	A-CA9	45	A-IOWR#
12	A-CA8	46	A-CA17
13	A-CA13	47	A-CA18
14	A-CA14	48	A-CA19
15	A-WE#	49	A-CA20
16	A-RDYBY#	50	A-CA21
17	A-VCC-C	51	A-VCC-C
18	A-VPP	52	A-VPP
19	A-CA16	53	A-CA22
20	A-CA15	54	A-CA23
21	A-CA12	55	A-CA24
22	A-CA7	56	A-CA25
23	A-CA6	57	A-VS2
24	A-CA5	58	A-RESET
25	A-CA4	59	A-WAIT#
26	A-CA3	60	A-INPACK
27	A-CA2	61	A-REG#
28	A-CA1	62	A-BVD2#
29	A-CA0	63	A-BVD1#
30	A-CD0	64	A-CD8
31	A-CD1	65	A-CD9
32	A-CD2	66	A-CD10
33	A-WP#	67	A-CD2#
34	GND	68	GND

Socket B:

Pin	Signal	Pin	Signal
1	GND	35	GND
2	B-CD3	36	B-CD1#
3	B-CD4	37	B-CD11
4	B-CD5	38	B-CD12
5	B-CD6	39	B-CD13
6	B-CD7	40	B-CD14
7	B-CE1#	41	B-CD15
8	B-CA10	42	B-CE2#
9	B-0E#	43	B-VS1
10	B-CA11	44	B-IORD#
11	B-CA9	45	B-IOWR#
12	B-CA8	46	B-CA17
13	B-CA13	47	B-CA18
14	B-CA14	48	B-CA19
15	B-WE#	49	B-CA20
16	B-RDYBY#	50	B-CA21
17	B-VCC-C	51	B-VCC-C
18	B-VPP	52	B-VPP
19	B-CA16	53	B-CA22
20	B-CA15	54	B-CA23
21	B-CA12	55	B-CA24
22	B-CA7	56	B-CA25
23	B-CA6	57	B-VS2
24	B-CA5	58	B-RESET
25	B-CA4	59	B-WAIT#
26	B-CA3	60	B-INPACK
27	B-CA2	61	B-REG#
28	B-CA1	62	B-BVD2#
29	B-CA0	63	B-BVD1#
30	B-CD0	64	B-CD8
31	B-CD1	65	B-CD9
32	B-CD2	66	B-CD10
33	B-WP#	67	B-CD2#
34	GND	68	GND

Index

A

- AC adapter 1-4
- AC power indicator
 - on LCD cover 1-8
 - on top panel 1-10
- advanced configuration and power interface (ACPI) 2-27
- advanced power management (APM) 2-27
- audio
 - audio system A-2
 - mute on/off 2-22
 - volume decrease 2-22
 - volume increase 2-22

B

- battery pack
 - battery power status indicator
 - on LCD cover 1-8
 - on top panel 1-10
 - charging 1-6
 - charging status indicator
 - on LCD cover 1-8
 - on top panel 1-10
 - inserting 1-5
 - low battery, indicator 1-10
 - proper handling 1-6
 - removing 1-5
- busy indicator, CD-ROM 2-16

C

- CD-ROM
 - busy indicator 2-16
 - cover, CD-ROM 1-17
 - emergency eject hole 2-16
 - module, removing 2-17

- CD-ROM module 2-17
- charging, battery indicator
 - on LCD cover 1-8
 - on top panel 1-10
- charging, battery pack 1-6
- Compact Discs
 - handling 2-19
 - loading 2-18
- components
 - menu, in SCU 3-12
 - audio device 3-13
 - COM ports 3-12
 - keyboard numlock 3-12
 - keyboard repeat 3-13
 - LPT port 3-12
 - PS/2 mouse port 3-12
 - ZV PCMCIA card support 3-13
- cover latch, LCD 1-7
- CRT port 1-12
 - attaching device 2-35
 - simultaneous display, with LCD 2-22

D

- DIP switch 2-3
 - for CPU core frequency 2-5
 - accessing 2-3
 - for CPU core voltage 2-6
 - accessing 2-6
 - for CPU I/O voltage 2-7
 - accessing 2-7
 - for flash ROM BIOS 2-5
 - accessing 2-3
- disks
 - menu, in SCU 3-11
 - diskette drives 3-11
 - IDE settings 3-11

display, LCD
 brightness
 decrease 2-22
 increase 2-22
 contrast
 decrease 2-22
 increase 2-22
 display expansion 2-22
 location 1-9
 open, how to 1-7
 panel features 2-26
 simultaneous display, with
 external monitor 2-22

E

eject button
 for CD-ROM 2-16
 for diskette 1-14, 2-14
 for PC card sockets 2-20
emergency eject hole, CD-ROM
 2-16
exit
 menu, in SCU 3-18
 default settings 3-18
 exit (no save) 3-18
 restore settings 3-18
 save and exit 3-18
 version info 3-18
external monitor (CRT) port 1-12
 attaching device 2-35
 simultaneous display, with
 LCD 2-22

F

floppy disk drive
 location 1-14
 inserting 2-14
 removing 2-14
Fn key function
 audio mute on/off 2-22
 audio volume decrease 2-22
 audio volume increase 2-22

Fn key function (*continued*)
 LCD brightness decrease
 2-22
 LCD brightness increase 2-22
 LCD contrast decrease 2-22
 LCD contrast increase 2-22
 suspend mode, entering 2-22
 switching display 2-22

H

hard disk drive
 in-use, indicator 1-10
 location 1-17
 removing 2-12
 replacing 2-13
 suspend mode 2-30
hard disk drive cover 2-12
hot keys, features 2-22

I

input interface
 built-in trackpad 1-9
 PS/2 type port 1-12
 USB port 1-12
 microphone-in jack 1-12
 serial port 1-12
inserting
 battery pack 1-5
 diskettes 2-14
 hard disk drive 2-12
 memory module 2-10
 PC card 2-20
I/O port pin assignments
 monitor port B-2
 parallel port B-1
 PC card sockets B-3, B-4
 PS/2 type port B-2
 serial port B-1
 USB port B-2

J

jack

- headphone jack 1-12
- microphone-in jack 1-12

K

keyboard

- location 1-9
- open, how to 2-3
- keyboard latches 2-3
- keyboard layout 2-23, 2-24
- keys, Windows 95
 - Application key 2-25
 - Windows key 2-25

L

latch

- battery pack 1-5
- keyboard 2-3
- LCD cover 1-7

LCD

- brightness
 - decrease 2-22
 - increase 2-22
 - contrast
 - decrease 2-22
 - increase 2-22
 - display expansion 2-22
 - location 1-9
 - open, how to 1-7
 - panel features 2-26
 - simultaneous display, with external monitor 2-22
- LED status indicators
- on LCD cover 1-8
 - on top panel 1-10
- locations
- DC-in socket 1-16
 - battery pack 1-5, 1-17
 - CD-ROM drive 1-14
 - CD-ROM eject button 2-16
 - cover latch, LCD 1-7

locations (*continued*)

- DIP switch
 - for CPU core frequency 2-5
 - for CPU core voltage 2-6
 - for CPU I/O voltage 2-7
 - for flash ROM BIOS 2-5
 - diskette eject button 1-14, 2-14
 - emergency eject hole, CD-ROM 2-16
 - external monitor port 1-12
 - floppy disk drive 1-14
 - Fn key 2-22
 - headphone jack 1-12
 - hard disk drive 1-17
 - hot keys 2-22
 - keyboard 1-9
 - keyboard latches 2-3
 - LCD 1-9
 - LED indicators
 - on LCD cover 1-8
 - on top panel 1-10
 - left-side stand 1-16
 - memory sockets 2-9, 2-10, 2-11
 - microphone, built-in 1-9
 - microphone-in jack 1-12
 - numeric keypad 2-24
 - parallel port 1-12
 - PC card eject buttons 2-21
 - PC card sockets 1-14
 - power button 1-10
 - PS/2 type port 1-12
 - processor 2-2
 - right-side stand 1-14
 - security connector 1-12
 - serial port 1-12
 - stereo speakers 1-9
 - trackpad and buttons 1-9
 - USB port 1-12
 - ventilation 1-16
- low battery, indicator 1-8, 1-10

M

- memory
 - expanding 2-8
 - menu, in SCU 3-10
 - cache systems 3-10
 - sockets 2-9
- memory module
 - installing 2-10
 - removing 2-11
- messages, POST 3-2, 3-3
- microphone, built-in 1-9
- microphone-in jack 1-12

N

- numeric keypad 2-24

O

- operating environment 1-3
- output interface
 - external monitor port 1-12
 - parallel port 1-12
 - headphone jack 1-12
 - stereo speakers 1-9

P

- parallel port 1-12
 - attaching device 2-34
- PC card
 - inserting 2-20
 - removing 2-21
- PC card sockets 1-14, 2-20
 - eject button 2-21
 - features 2-20
- PCMCIA card
 - See PC card
- POST 3-2
 - Messages
 - error detected 3-3
 - normal operation 3-2

power

- menu, in SCU 3-15
 - advance CPU controls 3-16
 - customize 3-15
 - enable battery low suspend 3-16
 - enable modem ring resume 3-16
 - enable power saving 3-15
 - high power saving 3-15
 - low power saving 3-15
 - medium power saving 3-15
 - resume timer 3-16
 - suspend controls 3-16
- power button 1-10
- power cord, usage 1-4
- power management 2-27
 - advanced configuration and power interface 2-27
 - advanced power management 2-27
- power on, indicator 1-10
- processor 2-2, A-1
 - replacing 2-2
- proper handling, battery pack 1-6
- PS/2 type port 1-12
 - attaching device 2-32

R

- rechargeable battery pack A-3
- recharging, battery pack 1-6
- removing
 - battery pack 1-5
 - CD-ROM module 2-17
 - diskettes 2-14
 - hard disk drive 2-12
 - memory module 2-11
 - PC cards 2-21
- replacing, CPU 2-2
- resume 2-29
 - from POS mode 2-29
 - from STD mode 2-30

S

SCU

See system configuration utility

security connector 1-12
attaching security lock 2-31

serial port 1-12
attaching device 2-33

setting

DIP switch 2-5, 2-6, 2-7

size and weight A-3

sockets, memory 2-9

sockets, PC card 1-14, 2-20

specifications

audio A-2

BIOS, system A-1

display A-1

input/output A-2

memory A-1

PC card sockets A-2

power management A-2

processor A-1

rechargeable battery pack
A-3

size and weight A-3

storage A-1

standby, global 2-28

startup

menu, in SCU 3-8

boot device 3-8

boot password 3-8

date and time 3-8

fast boot 3-8

SCU password 3-8

stereo speakers 1-9

suspend 2-29

Fn key function, using 2-22

indicator 1-10

powered on suspend 2-29

resume 2-29

suspend to disk 2-30

resume 2-30

system configuration utility

features 3-4

components menu 3-12

disks menu 3-11

exit menu 3-18

memory menu 3-10

power menu 3-15

startup menu 3-8

initiating 3-5

menu bar, working with 3-6

pull-down menu, working with
3-7

system status LED indicators

locations 1-8, 1-10

on LCD cover 1-8

battery status 1-8

power status 1-8

on top panel 1-10

battery status 1-10

hard disk status 1-10

power status 1-10

suspend status 1-10

T

trackpad and buttons 1-9

U

unpacking 1-2

upgrading CPU 2-2

USB port 1-12

attaching device 2-36

V

ventilation 1-16

