



# EP-MVP4A

**ISA/PCI Mainboard with Onboard AGP  
VGA PCI Audio, PCI IDE and Super  
Multi-I/O**

**TRADEMARK**

All products and company names are trademarks or registered trademarks of their respective holders.

*These specifications are subject to change without notice.*

*Manual Revision 3.1  
June 21, 1999*

## User Notice

No part of this product, including the product and software may be reproduced, transmitted, transcribed, stored in a retrieval system, or translated into any language in any form without the express written permission of EPoX Computer Company (hereinafter referred to as EPoX) except for documentation kept by the purchaser for backup purposes.

We provide this manual “as is” without warranty of any kind, either expressed or implied, including but not limited to the implied warranties or conditions of merchantability or fitness for a particular purpose. In no event shall EPoX be liable for any loss of profits, loss of business, loss of use or data, interruption of business or for indirect, special incidental, or consequential damages of any kind, even if EPoX has been advised of the possibility of such damages arising from any defect or error in the manual or product. EPoX may revise this manual from time to time without notice. For updated BIOS, drivers, or product release information you may visit our websites at <http://www.epox.com> or <http://www.epox.com.tw>.

Products mentioned in this manual are mentioned for identification purposes only. Product names appearing in this manual may or may not be registered trademarks or copyrights of their respective companies. **The product name and revision number are both printed on the mainboard itself.**

## Handling Procedures

Static electricity can severely damage your equipment. Handle the EP-MVP4A and any other device in your system with extreme care and avoid unnecessary contact with system components on the mainboard. Always work on an antistatic surface to avoid possible damage to the mainboard from static discharge. Always have the power supply unplugged and powered off when inserting and removing devices within the computer chassis. EPoX assumes no responsibility for any damage to the EP-MVP4A mainboard that results from failure to follow instruction or failure to observe safety precautions.



### CAUTION



**The EP-MVP4A mainboard is subject to damage by static electricity. Always observe the handling procedures.**

## **Technical Support Services**

If you need additional information, help during installation or normal use of this product, please contact your retailer. Your retailer will have the most current information about your configuration. If your retailer cannot help, you may visit our online technical support website and/or contact our support technicians at the locations listed below.

Record your serial number before installing your EP-MVP4A mainboard. (The serial number is located near the ISA slots at the edge of the board.)

**EP-MVP4A serial number:** \_\_\_\_\_

## **Contacting Technical Support**

EPoX technical support is working hard to answer all of your questions online. From our website you can find answers to many common questions, drivers, BIOS updates, tech notes, and important technical bulletins. If you are still unable to locate the solution you are seeking, you always have the option to contact our support technicians directly.

### **North American website (English language)**

<http://www.epox.com>

[sales@epox.com](mailto:sales@epox.com)

[support@epox.com](mailto:support@epox.com)

### **European website (Multi-language)**

<http://www.epox.nl>

[sales@epox.nl](mailto:sales@epox.nl)

[support@epox.nl](mailto:support@epox.nl)

### **Taiwan website (Chinese language)**

<http://www.epox.com.tw>

[sales@epox.com.tw](mailto:sales@epox.com.tw)

[support@epox.com.tw](mailto:support@epox.com.tw)

*Thank you for using EPoX mainboards!*

*Copyright 1999 EPoX Computer Company. All rights reserved.*

---

---

## Table of Contents

---

<b>Section 1</b>	<b>Introduction</b>	<b>Page</b>
	Components Checklist .....	1-1
	<b>Overview</b>	
	Power-On/Off (Remote) .....	1-2
	System Block Diagram .....	1-3
<b>Section 2</b>	<b>Features</b>	
	EP-MVP4A Features .....	2-1
<b>Section 3</b>	<b>Installation</b>	
	EP-MVP4A Detailed Layout .....	3-2
	<b>Easy Installation Procedure</b>	
	Configure Jumpers .....	3-3
	System Memory Configuration .....	3-5
	Device Connectors .....	3-8
	External Modem Ring-in Power ON and Keyboard Power ON Function (KBPO) .....	3-10
<b>Section 4</b>	<b>Award BIOS Setup</b>	
	BIOS Instructions .....	4-1
	Standard CMOS Setup .....	4-2
	BIOS Features Setup .....	4-3
	Chipset Features Setup .....	4-8
	Power Management Setup .....	4-11
	PNP/PCI Configuration .....	4-14
	Load Setup Defaults .....	4-16
	Integrated Peripherals .....	4-16
	Sensor And CPU Speed Setup .....	4-20
	Change Supervisor or User Password .....	4-21
	IDE HDD Auto Detection .....	4-22

---

HDD Low Level Format ..... 4-24  
Save & Exit Setup ..... 4-24  
Exit Without Saving ..... 4-24

***Appendix***

***Appendix A***

Memory Map ..... A-1  
I/O Map ..... A-1  
Timer & DMA Channels Map ..... A-2  
Interrupt Map ..... A-2  
RTC & CMOS RAM Map ..... A-3

***Appendix B***

POST Codes ..... A-5  
Unexpected Errors ..... A-8

***Appendix C***

Load Setup Defaults ..... A-9

***Appendix D***

Sound Driver Quick Installation Guide ..... A-10

---



**Section 1**  
**INTRODUCTION**

**Components Checklist**

- ✓ A. (1) One mainboard
- ✓ B. (1) One user's manual
- ✓ C. (1) Floppy drive ribbon cable
- ✓ D. (1) ATA-66 hard drive ribbon cable
- ✓ E. (1) COM Port Connector
- ✓ F. (1) Ultra\_DMA IDE driver diskette  
(1) AGP Drivers  
(1) Audio Drivers

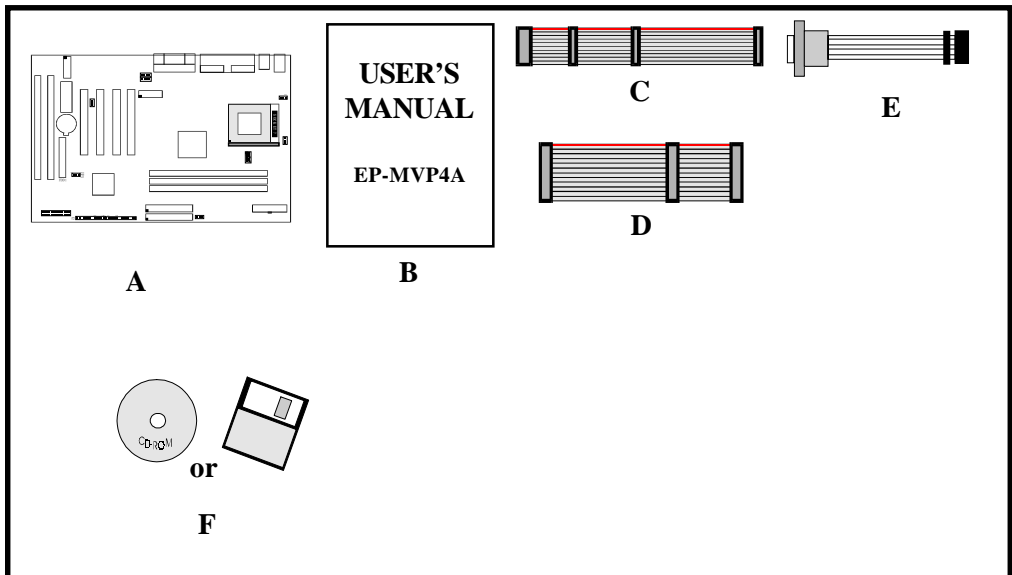

## Power-On/Off (Remote)

The **EP-MVP4A** has a single 20-pin connector for ATX power supplies. For ATX power supplies that support the **Remote On/Off** feature, this should be connected to the systems front panel for system Power On/Off button. The systems power On/Off button should be a momentary button that is normally open.

The **EP-MVP4A** has been designed with "Soft Off" functions. You can turn Off the system from one of two sources: The first is the front panel Power On/Off button, and the other is the "Soft Off" function (coming from the EP-MVP4A's onboard circuit controller) that can be controlled by the operating system. Windows 95/98 will control this when the user clicks that they are ready to Shutdown the system.

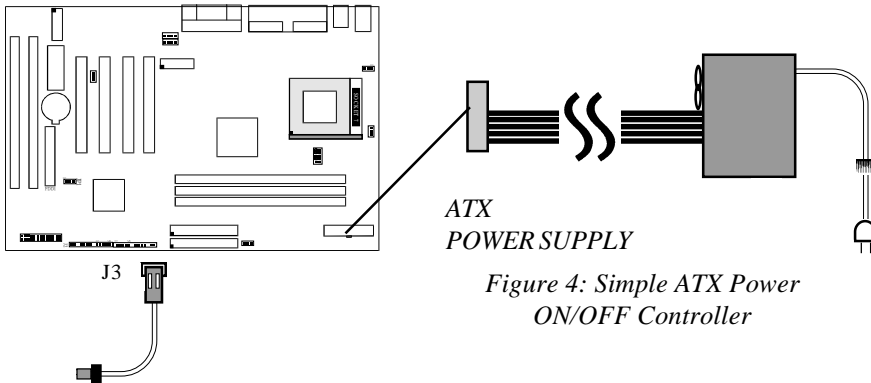

Figure 4: Simple ATX Power  
ON/OFF Controller

### EP-MVP4A Board

Case (chassis) Power  
ON/OFF button



# System Block Diagram

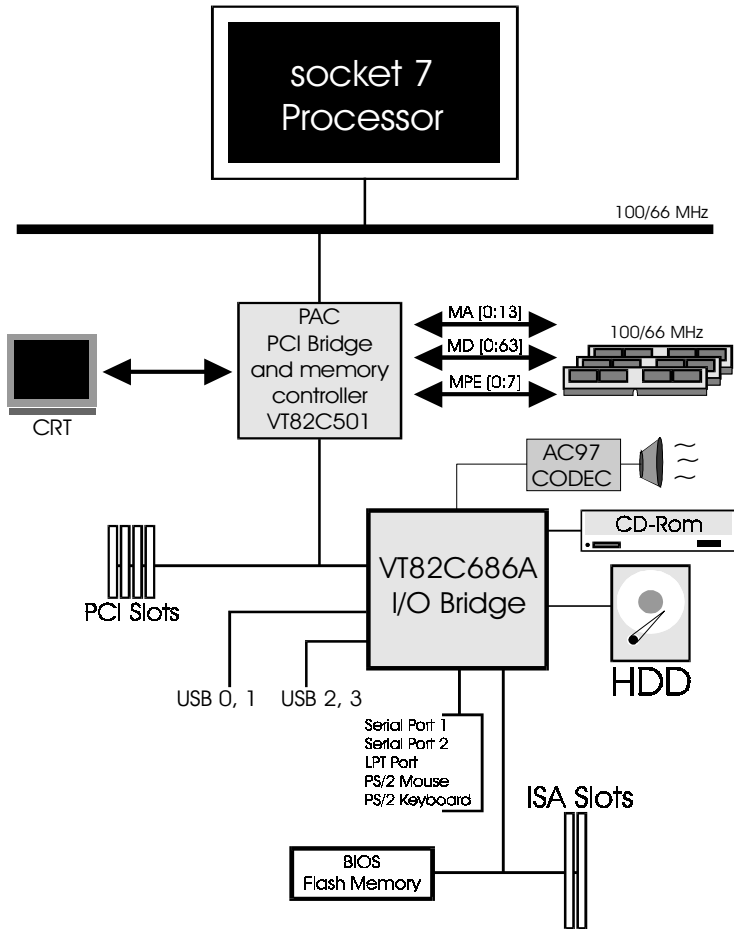

Figure 5: System Block Diagram

**Page Left Blank**

---

---

## Section 2

# FEATURES

---

### EP-MVP4A Features:

---

- Intel **Pentium®** Processor, Pentium Processor with MMX technology, AMD K5/K6, Cyrix 6x86L/6x86MX & *idt* C6 operating at **133 ~ 450 MHz** with **321 ZIF socket 7** provides scalability to accept faster Processors in the future.
- Designed with VIA MVP4 AGPset.
- Supports up to 384 MB of DRAM (minimum of 16 MB) on board, You can use 168-pin DIMM x 3. It will automatically detect Extended Data Output (EDO) DRAM at 66MHz only or Synchronous DRAM memory (SDRAM) at 66MHz or 100MHz (please see Section 3-2).
- Supports (2) 16 bit ISA slots, (4) 32 bit PCI slots, and provides (2) independent high performance PCI IDE interfaces capable of supporting PIO Mode 3/4 and Ultra DMA 33/66 devices. The EP-MVP4A supports (4) PCI Bus Master slots and a jumperless PCI INT# control scheme which reduces configuration confusion when plugging in PCI card(s).
- Supports ATAPI (e.g. CD-ROM) devices on both Primary and Secondary IDE interfaces.
- Designed with Integrated Multi I/O: (1) floppy port, (1) parallel port (EPP, ECP), and (2) serial ports (16550 Fast UART).  
Note: Japanese “Floppy 3 mode” is also supported
- Features Award Plug & Play BIOS. With Flash Memory you can always upgrade to the current BIOS as they are released. (<http://www.epox.com> please visit our Technical Support section for the latest updates).
- EP-MVP4A utilizes a Lithium battery which provides environmental protection and longer battery life.
- Software power-down when using Windows® 95/98.
- Supports ring-in feature (remote power-on through external modem, allows system to be turned on remotely).

- Resume by Alarm - Allows your system to turn on at a preselected time.
- Supports CPU Hardware sleep and SMM (System Management Mode).
- Supports Keyboard power ON function (KBPO).
- Supports USDM software to offer motherboard various status.
- Supports the CPU and Chassis fan Auto stop in sleep mode.
- Built-in WOL (Wake On Lan) Connector.
- Built-in Sound Blaster compatible/DirectSound AC97 Audio.
- Built-in AGP 2D/3D Graphics Accelerator.

## Section 3

# INSTALLATION

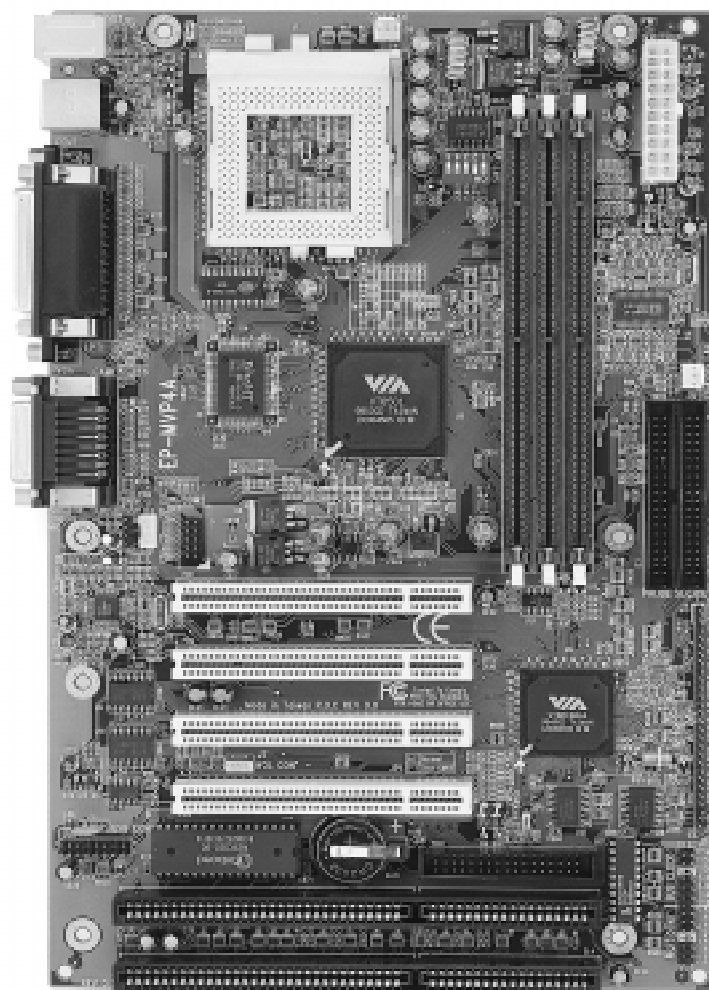

# EP-MVP4A Detailed Layout

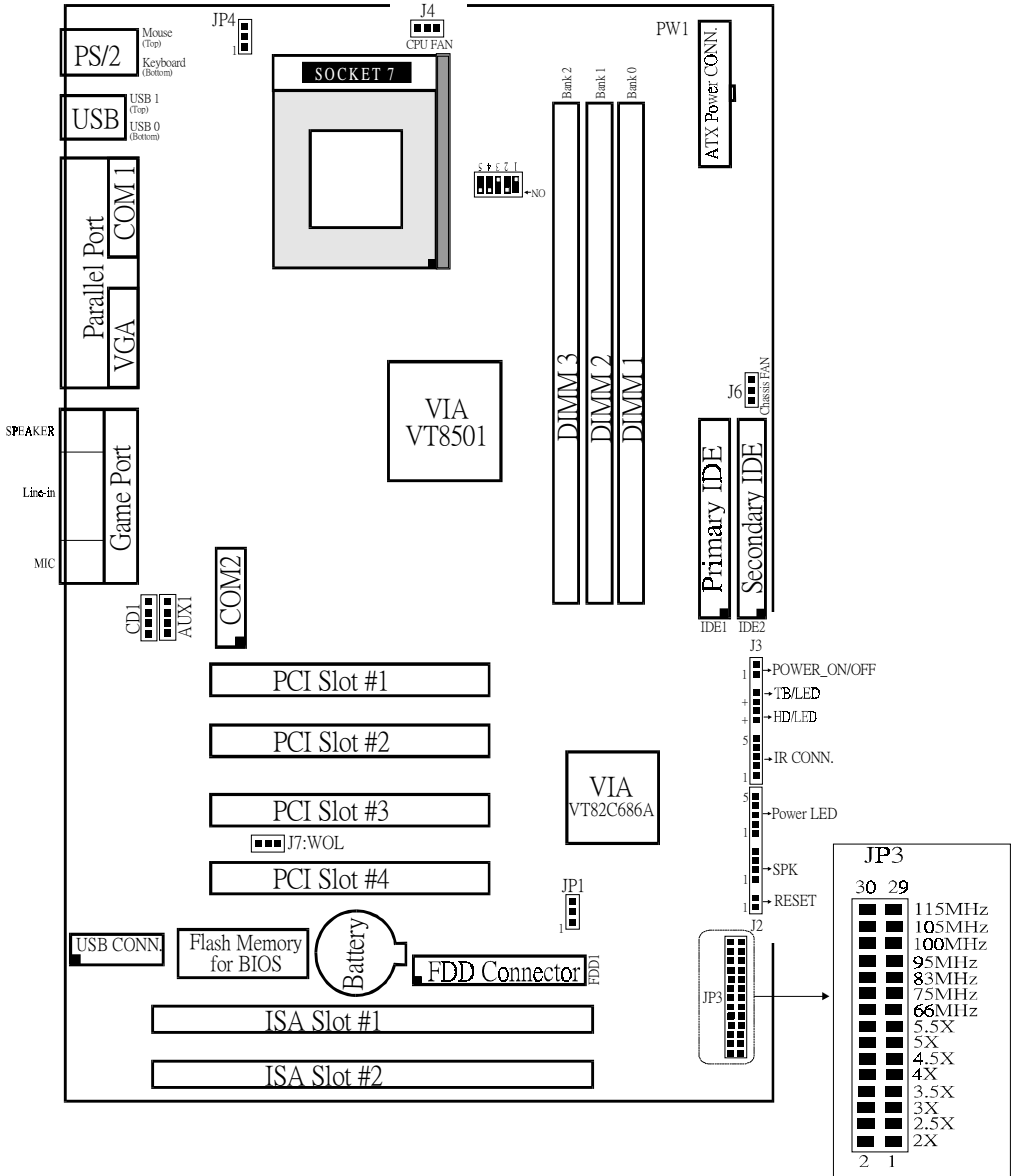

Figure 1

## Easy Installation Procedure

The following must be completed before powering on your new system:

- 3-1. **Configure Jumpers**
- 3-2. **System Memory Configuration**
- 3-3. **Device Connectors**
- 3-4. **External Modem Ring-in Power ON and Keyboard Power ON Functions (KBPO)**

### Section 3-1 Configure Jumpers

We design this motherboard with the fewest jumpers to make your install fast and easy.

The following will describe all of the jumpers that you are required to set before moving on to step 3-2.

*Note: The jumpers as depicted as shown (Figure 1) in their correct physical orientation.*

JP1



CMOS Clear

- JP1 = 1-2 - Run Mode (Default)  
 = 2-3 - Clear CMOS (momentarily)

JP4



Keyboard Power-ON function (refer to the section 3-4)

- JP4 = 1-2 - Disabled(Default)  
 = 2-3 - Enabled

J7



WOL (Wake On Lan) Connector

Reserved for NIC (Network Interface Card) to Wake the System.

**SW1: CPU Vcore Voltage Selection**

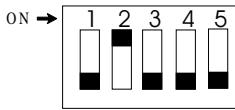

SW 1					CPU
1	2	3	4	5	V <sub>core</sub>
	ON		ON	ON	1.8V
	ON	ON	ON	ON	2.0V
ON					2.1V
	ON				2.2V
ON	ON				2.3V
		ON			2.4V
			ON		2.8V
ON			ON		2.9V
		ON	ON		3.2V

**JP3: CPU Speed Selection**

**ESDJ**  
**JP3**  
30 29

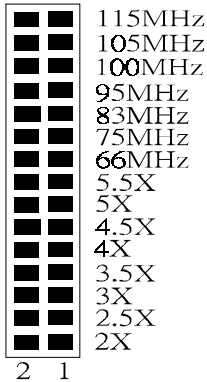

\* Reserved

Pentium/MMX AMD K5/K6 IDT-C6	JP3		Cyrix/IBM 6x86MX/MII
	Multiplier	Bus Clock	
166MHz	2.5X	66MHz	PR200
		75MHz	PR233
		83MHz	PR266
		95MHz	PR300
250MHz	3X	100MHz	PR366
200MHz		66MHz	PR266
		75MHz	PR300
250MHz		83MHz	PR333
	3.5X	95MHz	*PR400
300MHz		100MHz	*PR433
233MHz		66MHz	PR300
		75MHz	PR333
	4X	83MHz	*PR400
333MHz		95MHz	*PR466
350MHz		100MHz	*PR500
266MHz		66MHz	PR333
	4.5X	75MHz	PR400
333MHz		83MHz	*PR466
380MHz		95MHz	*PR533
400MHz		100MHz	*PR550
300MHz	5X	66MHz	
450MHz		100MHz	
333MHz	5.5X	66MHz	
475MHz		95MHz	
500MHz		100MHz	
366MHz		66MHz	



## Section 3-2 System Memory Configuration

### Memory Layout

The EP-MVP4A supports (3) 168-pin DIMMs (Dual In-line Memory Module). The DIMMs can be either EDO (Extended Data Out) or SDRAM (Synchronized DRAM). The DIMMs may be installed using just one chip.

- **We recommend using SDRAM DIMM can not mixing with EDO DIMM modules.**
- DIMM SDRAM may be 83MHz (-12ns), 100MHz (-10ns) or 125MHz (-8ns) bus speed.
- No Registered DIMM support.

Figure 2 and Table 1 show several possible memory configurations using

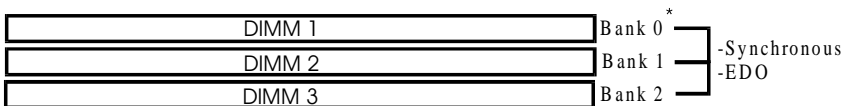

Total Memory	DIMM 1 (Bank 0)	DIMM 2 (Bank 1)	DIMM 3 (Bank 2)
= 128MB Maximum	EDO/SDRAM* 8MB, 16MB, 32MB, 64MB, 128MB X 1	None	None
= 256MB Maximum	EDO/SDRAM* 8MB, 16MB, 32MB, 64MB, 128MB X 1	EDO/SDRAM* 8MB, 16MB, 32MB, 64MB, 128MB X 1	None
= 384MB Maximum	EDO/SDRAM* 8MB, 16MB, 32MB, 64MB, 128MB X 1	EDO/SDRAM* 8MB, 16MB, 32MB, 64MB, 128MB X 1	EDO/SDRAM* 8MB, 16MB, 32MB, 64MB, 128MB X 1

Table 1

\* SDRAM only supports 8, 16, 32, 64, 128MB DIMM modules.

\* We recommend to use PC100 Memory Module for bus speed between 100MHZ and 66MHZ.

## DIMM Module Installation

Figure 3 displays the notch marks and what they should look like on your DIMM memory module.

DIMMs have 168-pins and two notches that will match with the onboard DIMM socket. DIMM modules are installed by placing the chip firmly into the socket at a 90 degree angle and pressing straight down (figure 4) until it fits tightly into the DIMM socket (figure 5).

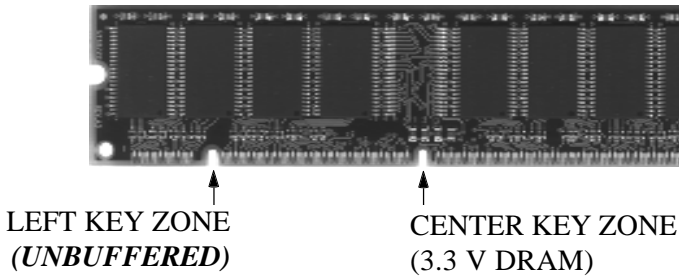

*Figure 3*

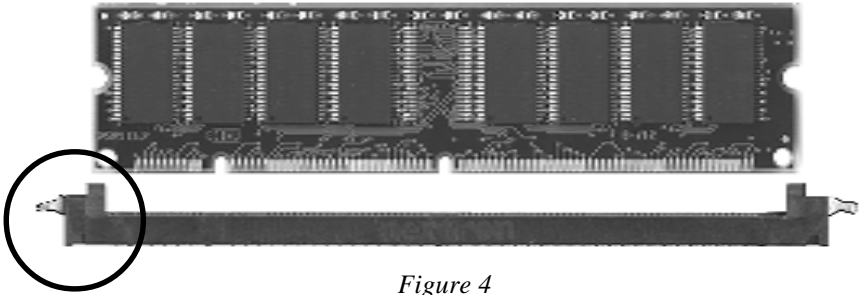

Figure 4

DIMM Module clip before installation

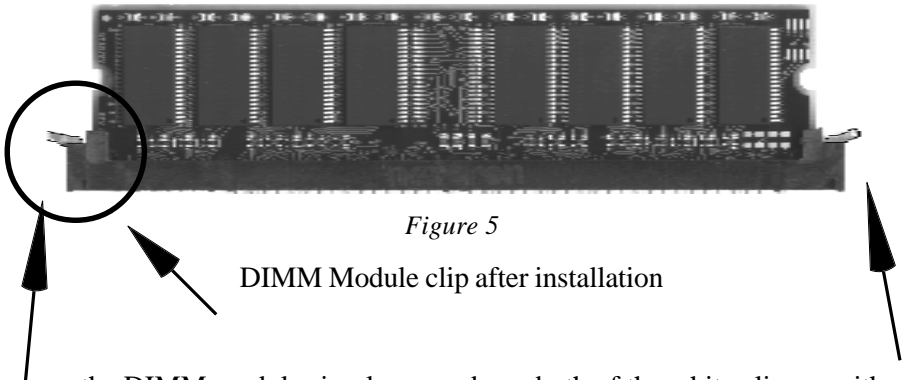

Figure 5

DIMM Module clip after installation

To remove the DIMM module simply press down both of the white clips on either side and the module will be released from the socket.

## Section 3-3

### Device Connectors

Please install the motherboard into the chassis.

Now that your motherboard is installed you are ready to connect all your connections (figure 6).

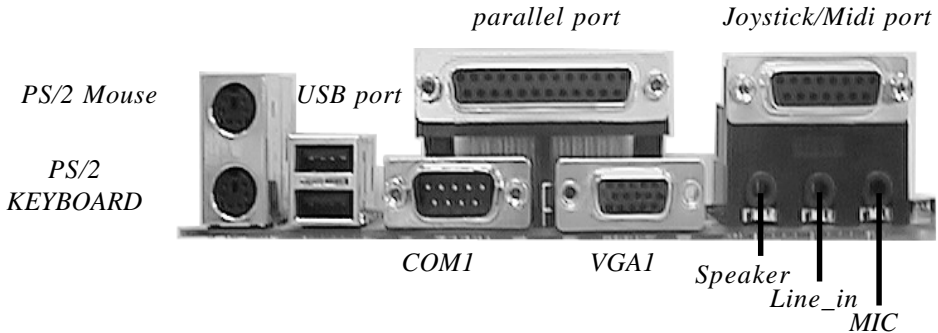
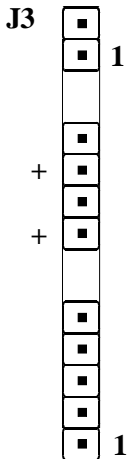

Figure 6

- J4:** CPU Fan Power
- A plug-in for the CPU Fan Power
- J6:** Chassis Fan Power
- A plug-in for the chassis Fan Power
- J7:** WOL (Wake On Lan) Connector
- PW1:** ATX Power Connector
- 20-pin power connector
- J2,J3:** Chassis Panel Connector
- Power\_LED, Speaker, Reset, Sleep, Turbo LED and HDD LED
- IDE1:** Primary IDE Connector
- IDE2:** Secondary IDE Connector
- FDD1:** Floppy Controller Connector
- CD1:** CD-ROM Audio\_in
- AUX1:** AUX Audio\_in
- COM2:** RS232 COM2 Connector
- USB CONN.:** The third and fourth USB port (cable optional)

**Device Connectors (continued)**

(This is connected to the power button on the case. Using the Soft-Off by Pwr-BTTN feature, you can choose either Instant Off (turns system off immediatly), or 4 sec delay (you need to hold the button down for 4 seconds before the system turns off). When the system is in 4 sec delay mode, there is a special feature to make the system to go into suspend mode when the button is pressed momentarily.)



**Power On/Off**

**Turbo LED indicator** - LED ON when higher speed is selected

**IDE LED indicator** - LED ON when Onboard PCI IDE Hard disks is activate

**IR Connector**

- |         |         |
|---------|---------|
| 1. VCC  | 4. GND  |
| 2. NC   | 5. IRTX |
| 3. IRRX |         |

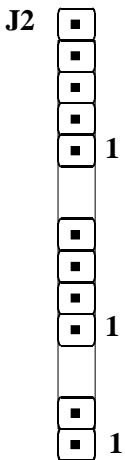

**Power LED** - Power LED connector

- |                 |        |
|-----------------|--------|
| 1. Power LED(+) | 4. NC  |
| 2. N/C          | 5. GND |
| 3. GND          |        |

**Speaker** - Connect to the system's speaker for beeping

- |            |        |
|------------|--------|
| 1. Speaker | 3. GND |
| 2. N/C     | 4. GND |

**Reset** - Closed to restart system.

## Section 3-4

### External Modem Ring-in Power ON and Keyboard Power ON Functions (KBPO)

---

On the basis of bounded functions in I/O chipset, the two serial ports are able to support the External Modem Ring-in Power ON function. Once users connect the external modem to COM1 or COM2, the EP-MVP4A mainboard allows users to turn on their system through the remote and host's dial-up control.

#### Exclusive Keyboard Power ON Function

To innovate a unique feature to benefit users, we devoted the easiest and most convenient way to turn on your system based on the the ATX power supply.

How to work with it

**Step 1:** Please check JP4 at the position 2-3 after you finished the system installation.

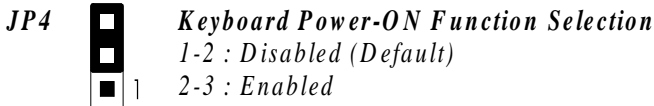

**Step 2:** You can enjoy the Keyboard Power ON function (KBPO) by *pressing any 2 key*. Your system will be turned on automatically, after releasing the keys. To power off you system, you can use the Soft-OFF function under Windows 95.

#### Notes:

1. Intel ATX version 2.0 specification has recommended you use the power supply with 0.72A(720mA) in 5.0VSB. With our EP-MVP4A mainboard, *the 5.0VSB standby power only has to be  $\geq 0.2A$  (200mA)* then you can enjoy this unique benefit. However, the ATX power supply which is  $< 0.2$  (200mA) is still applicable to your system by placed JP4 at the position 1-2 to disable this feature.

# Section 4

## AWARD BIOS SETUP

### BIOS Instructions

Award's ROM BIOS provides a built-in Setup program which allows user to modify the basic system configuration and hardware parameters. The modified data will be stored in a battery-backed CMOS, so that data will be retained even when the power is turned off. In general, the information saved in the CMOS RAM will stay unchanged unless there is a configuration change in the system, such as hard drive replacement or a device is added.

It is possible for the CMOS battery to fail, this will cause data loss in the CMOS only. If this does happen you will need to reconfigure your BIOS settings.

#### To enter the Setup Program :

Power on the computer and press the <Del> key immediately, this will bring you into the BIOS CMOS SETUP UTILITY.

ROM PCI / ISA BIOS (2A5LHPA9)  
 CMOS SETUP UTILITY  
 AWARD SOFTWARE, INC.

STANDARD CMOS SETUP BIOS FEATURES SETUP CHIPSET FEATURES SETUP POWER MANAGEMENT SETUP PNP/PCI CONFIGURATION INTEGRATED PERIPHERALS LOAD SETUP DEFAULTS	SENSOR AND CPU SPEED SETUP SUPERVISOR PASSWORD USER PASSWORD IDE HDD AUTO DETECTION SAVE & EXIT SETUP EXIT WITHOUT SAVING
ESC : QUIT F10 : Save & Exit Setup	
↑ ↓ → ← : SELECT ITEM (Shift)F2 : Change Color	
Time, Date, Hard Disk Type...	

*Figure 1: CMOS Setup Utility*

The menu displays all the major selection items. Select the item you need to reconfigure. The selection is made by moving the cursor (press any direction key ) to the item and pressing the 'Enter' key. An on-line help message is displayed at the bottom of the screen as the cursor is moved to various items which provides a better understanding of each function. When a selection is made, the menu of the selected item will appear so that the user can modify associated configuration parameters.

### 4-1 Standard CMOS Setup

Choose "Standard CMOS Setup" in the CMOS SETUP UTILITY Menu (Figure 2). The Standard CMOS Setup allows the user to configure system settings such as the current date and time, type of hard disk drive installed, floppy drive type, and display type. Memory size is auto-detected by the BIOS and displayed for your reference. When a field is highlighted (use direction keys to move the cursor and the <Enter> key to select), the entries in the field can be changed by pressing the <PgDn> or the <PgUp> key.

ROM PCI/ISA BIOS(2A5LHPA9)  
 STANDARD CMOS SETUP  
 AWARD SOFTWARE, INC.

Date (mm:dd:yy) : Wed, Apr 17 1996																						
Time (hh:mm:ss) : 14 : 30 : 50																						
HARD DISKS	TYPE	SIZE	CYLS	HEAD	PRECOMP	LANDZONE	SECTORS	MODE														
Primary Master	: <b>Auto</b>	0	0	0	0	0	0	<b>Auto</b>														
Primary Slave	: <b>Auto</b>	0	0	0	0	0	0	<b>Auto</b>														
Secondary Master	: <b>Auto</b>	0	0	0	0	0	0	<b>Auto</b>														
Secondary Slave	: <b>Auto</b>	0	0	0	0	0	0	<b>Auto</b>														
Drive A : 1.44M, 3.5 in.					<table border="1"> <tr> <td>Base Memory</td> <td>:</td> <td>640K</td> </tr> <tr> <td>Extended Memory</td> <td>:</td> <td>56320K</td> </tr> <tr> <td>Other Memory</td> <td>:</td> <td>384K</td> </tr> <tr> <td colspan="2">Total Memory</td> <td>:</td> <td>57344K</td> </tr> </table>					Base Memory	:	640K	Extended Memory	:	56320K	Other Memory	:	384K	Total Memory		:	57344K
Base Memory	:	640K																				
Extended Memory	:	56320K																				
Other Memory	:	384K																				
Total Memory		:	57344K																			
Drive B : None																						
Floppy 3 Mode Support : Disabled																						
Video : EGA/VGA																						
Halt On : All, But Keyboard																						
ESC : Quit			↑ ↓ → ← : Select Item			PU/PD/+/- : Modify																
F1 : Help			(Shift) F2 : Change Color																			

Figure 2: Standard CMOS Setup

**NOTE: If the hard disk Primary Master/Slave and Secondary Master/Slave are set to Auto, then the hard disk size and model will be auto-detected.**



*NOTE: The “Halt On:” field is used to determine when to halt the system by the BIOS if an error occurs.*

*NOTE: Floppy 3 Mode support is a mode used to support a special 3.5” drive used in Japan. This is a 3.5” disk that stores only 1.2 MB, the default setting for this is disabled.*

## 4-2 BIOS Features Setup

Selecting the “BIOS FEATURES SETUP” option in the CMOS SETUP UTILITY menu allows users to change system related parameters in the displayed menu. This menu shows all of the manufacturer’s default values for the EP-MVP4A.

Pressing the [F1] key will display a help message for the selected item.

ROM PCI/ISA BIOS(2A5LHPA9)  
 BIOS FEATURES SETUP  
 AWARD SOFTWARE, INC.

Virus Warning	: Disabled	Video BIOS	Shadow	: Enabled
CPU Internal Cache	: Enabled	C8000-CBFFF	Shadow	: Disabled
External Cache	: Enabled	CC000-CFFFF	Shadow	: Disabled
Quick Power On Self Test	: Enabled	D0000-D3FFF	Shadow	: Disabled
Boot Sequence	: A, C, SCSI	D4000-D7FFF	Shadow	: Disabled
Swap Floppy Drive	: Disable	D8000-DBFFF	Shadow	: Disabled
Boot Up Floppy Seek	: Enabled	DC000-DFFFF	Shadow	: Disabled
Boot Up NumLock Status	: On	Diskette Access For		: All
Gate A20 option	: Fast			
Memory Parity/ECC Check	: Disabled			
Typematic Rate Setting	: Disabled			
Typematic Rate (Chars/Sec)	: 6			
Type matic Delay (Msec)	: 250			
Security Option	: Setup			
PCI/VGA Palette Snoop	: Disabled	Esc : Quit	↑ ↓ → ←	: Select Item
OS Select For DRAM > 64MB	: Non-OS2	F1 : Help	PU/PD/+/-	: Modify
Report No FDD For WIN 95	: Yes	F5 : Old Values	(Shift) F2	: Color
		F7 : Load Setup Defaults		

Figure 3: BIOS Features Setup

**Virus Warning:** During and after the system boots up, any attempt to write to the boot sector or partition table of the hard disk drive will halt the system and an error message will appear.

You should then run an anti-virus program to locate the virus. Keep in mind that this feature protects only the boot sector, not the entire hard drive.

The default value is Disabled.

**Enabled:** Activates automatically when the system boots up causing a warning message to appear when anything attempts to access the boot sector.

**Disabled:** No warning message will appear when anything attempts to access the boot sector.

**Note:** Many disk diagnostic programs that access the boot sector table can trigger the virus warning message. If you plan to run such a program, we recommend that you first disable the virus warning.

**CPU Internal Cache:** This controls the status of the processor's internal cache area.

The default is Enabled.

**Enabled:** This activates the processor's internal cache thereby increasing performance.

**Disabled:** This deactivates the processor's internal cache thereby lowering performance.

**External (L2) Cache:** This controls the status of the external (L2) cache area.

The default is Enabled.

**Enabled:** This activates the motherboard's L2 cache thereby increasing performance.

**Disabled:** This deactivates the motherboard's L2 cache thereby lowering performance.

**Quick Power On Self Test:** This category speeds up the Power On Self Test (POST).

The default is Enabled.

**Enabled:** This setting will shorten or skip of the items checked during POST.

**Disabled:** Normal POST.

**Boot Sequence:** This category determines which drive is searched first by the O/S (Operating System).

The default is A,C,SCSI.

*The following is your list of options:*

[A, C, SCSI] - [C, A, SCSI] - [C, CD-ROM, A] - [CD-ROM, C, A]

[D, A, CD-ROM], [E, A, CD-ROM] - [F, A, CD-ROM] - [SCSI, A, C]

[SCSI C, A] - [C Only]

**Swap Floppy Drive:** This will swap your physical drive letters A & B if you are using two floppy disks.

The default is Disabled.

*Enabled:* Floppy A & B will be swapped under the O/S.

*Disabled:* Floppy A & B will be not swapped.

**Boot Up Floppy Seek:** During Power-On-Self-Test (POST), BIOS will determine if the floppy disk drive installed is 40 or 80 tracks. Only 360K type is 40 tracks while 760K, 1.2MB and 1.44MB are all 80 tracks.

The default is Enabled.

*Enabled:* The BIOS will search the floppy disk drive to determine if it is 40 or 80 tracks.

*Disabled:* The BIOS will not search for the type of floppy disk drive by track number.

**NOTE:** BIOS can not tell the difference between 720K, 1.2MB and 1.44MB drive types as they are all 80 tracks.

**Boot Up NumLock Status:** This controls the state of the NumLock key when the system boots.

The default is On.

*On:* The keypad acts as a 10-key pad.

*Off:* The keypad acts like the cursor keys.

**Gate A20 Option:** This refers to the way the system addresses memory above 1MB (extended memory).

The default is Fast.

*Normal:* The A20 signal is controlled by the keyboard controller or chipset hardware.

*Fast:* The A20 signal is controlled by Port 92 or chipset specific method.

**Typematic Rate Setting:** This determines the keystrokes repeat rate.

The default is Disabled.

*Enabled:* Allows typematic rate and typematic delay programming.

*Disabled:* The typematic rate and typematic delay will be controlled by the keyboard controller in your system.

**Typematic Rate (Chars/Sec):** This is the number of characters that will be re-

peated by a keyboard press.  
The default is 6.

*6: 6 characters per second. 8: 8 characters per second.  
10: 10 characters per second. 12: 12 characters per second.  
15: 15 characters per second. 20: 20 characters per second.  
24: 24 characters per second. 30: 30 characters per second.*

**Typematic Delay (msec):** This setting controls the time between the first and the second character displayed by typematic auto-repeat.

The default is 250.

*250: 250 msec.  
500: 500 msec.  
750: 750 msec.  
1000: 1000 msec.*

**Security Option:** This category allows you to limit access to the System and Setup, or just to Setup.

The default is Setup.

***System:** The system will not boot and the access to Setup will be denied if the correct password is not entered at the prompt.*

***Setup:** The system will boot; but the access to Setup will be denied if the incorrect password is not entered at the prompt.*

**PCI/VGA Palette Snoop:** This field controls the ability of a primary PCI VGA controller to share a common palette (When a snoop write cycles) with an ISA video card.

The default is Disabled.

***Enabled:** If an ISA card is connected to a PCI VGA card via the VESA connector, and that ISA card connects to a VGA monitor, then that ISA card uses the RAMDAC of the PCI card.*

***Disabled:** Disables the VGA card Palette Snoop function.*

**OS Select For DRAM > 64MB:** Some operating systems require special handling. Use this option only if your system has greater than 64MB of memory.

The default is Non-OS2.

***OS2:** Select this if you are running the OS/2 operating system with greater than 64MB of RAM.*

*Non-OS2: Select this for all other operating systems and configurations.*

**Video BIOS Shadow:** This option allows video BIOS to be copied into RAM. Video Shadowing will increase the video performance of your system. The default is Enabled.

*Enabled: Video shadow is enabled.*

*Disabled: Video shadow is disabled.*

**C8000 - CBFFF Shadow:**

**CC000 - CFFFF Shadow:**

**D0000 - D3FFF Shadow:**

**D4000 - D7FFF Shadow:**

**D8000 - DBFFF Shadow:**

**DC000 - DFFFF Shadow:**

These categories determine whether ROMs from option cards will be copied into RAM. This will be in 16K byte or 32K byte units, and the size will depend on chipset of the option card.

*Enabled: Optional shadow is enabled.*

*Disabled: Optional shadow is disabled.*

### 4-3 Chipset Features Setup

Choose the “CHIPSET FEATURES SETUP” in the CMOS SETUP UTILITY menu to display following menu.

ROM PCI/ISA BIOS(2A5LHPA9)  
 CHIPSET FEATURES SETUP  
 AWARD SOFTWARE, INC.

Bank 0/1 DRAM Timing	: SDRAM Fast	OnChip USB	: Enabled
Bank 2/3 DRAM Timing	: SDRAM Fast	USB Keyboard Support	: Disabled
Bank 4/5 DRAM Timing	: SDRAM Fast	OnChip AGP	: Enabled
SDRAM Cycle length	: 3	OnChip Sound	: Enabled
DRAM Page-Mode	: Enabled		
DRAM Fast Decoding	: Disabled		
DRAM Read Pipeline	: Disabled		
Sustained 3T Write	: Enabled		
Cache R/CPU W Pipeline	: Enabled		
Cache Timing	: Fastest		
Video BIOS Cacheabled	: Enabled		
System BIOS Cacheabled	: Disabled		
Memory Hole	: Disabled		
Init Display First	: PCI Slot		
Frame Buffer Size	: 8M		
AGP Aperture Size	: 64M		
		Esc : Quit	↑ ↓ → ← : Select Item
		F1 : Help	PU/PD/+/- : Modify
		F5 : Old Values	(Shift) F2 : Color
		F7 : Load Setup Defaults	

Figure 4: Chipset Features Setup

**Bank 0/1, 2/3, 4/5 DRAM Timing:** This value in this field is set by the system board manufacturer, depending on whether the board has paged DRAMs or EDO (extended data output) DRAMs.

The Choice: Bank 0/1, 2/3, 4/5.

**SDRAM Cycle length:** This setting defines the CAS timing parameter of the SDRAM in terms of clocks.

The default is 3.

2: Provides faster memory performance.

3: Provides better memory compatibility.

**DRAM Read Pipeline:** You may select *Enabled* for this field when PBSRAMs are installed. Pipelining improves system performance.

The Choice: Enabled, Disabled.

**Sustained 3T Write:** This item allow you to enable or disable direct map write back / write through secondary cache.

The Choice: Enabled, Disabled.

**Cache R/CPU W Pipeline:** This item allows you to enable/disabled the cache timing.

The Choice: Enabled, Disabled.

**Video BIOS Cacheable:** When enabled. The Video BIOS cache will cause access to video BIOS addressed at C0000H to C7FFFH to be cached, if the cache controller is also enabled

The Choice: Enabled, Disabled.

**System BIOS Cacheable:** As with caching the Video BIOS above, enabling this selection allows accesses to the system BIOS ROM addressed at F0000H-FFFFFH to be cached, provided that the cache controller is enabled.

The Choice: Enabled, Disabled.

**Memory Hole:** You can reserve this memory area for the use of ISA adaptor ROMs.

The default is Disabled.

***Enabled:** This field enables the main memory (15~16MB) to remap to ISA BUS.*

***Disabled:** Normal Setting.*

***NOTE:** If this feature is enabled you will not be able to cache this memory segment.*

**Init Display First:** If two video cards are used (1 AGP and 1 PCI) this specifies which one will be the primary display adapter.

The default is PCI Slot.

***PCI Slots:** PCI video card will be primary adapter.*

***AGP:** AGP video card will be primary adapter.*

**AGP Aperture Size:** The amount of system memory that the AGP card is allowed to share.

The default is 64.

***4:** 4MB of systems memory accessible by the AGP card.*

***8:** 8MB of systems memory accessible by the AGP card.*

*16: 16MB of systems memory accessible by the AGP card.*

*32: 32MB of systems memory accessible by the AGP card.*

*64: 64MB of systems memory accessible by the AGP card.*

*128: 128MB of systems memory accessible by the AGP card.*

*256: 256MB of systems memory accessible by the AGP card.*

**Frame Buffer Size:** Specify the size of system memory to allocate for video memory, from 1 MB to 8 MB.

The Choice: NA, 2MB, 4MB, 8MB.

**OnChip USB:** Select Enabled if your system contains a Universal Serial Bus(USB) controller and you have a USB peripheral.

**USB Keyboard Support:** This controls the activation status of an optional USB keyboard that may be attached.

The default is disabled.

*Enabled: Enable USB keyboard support.*

*Disabled: Disable USB keyboard support.*



## 4-4 Power Management Setup

Choose the “POWER MANAGEMENT SETUP” in the CMOS SETUP UTILITY to display the following screen. This menu allows the user to modify the power management parameters and IRQ signals. In general, these parameters should not be changed unless it’s absolutely necessary.

ROM PCI/ISA BIOS (2A5LHPA9)  
 POWER MANAGEMENT SETUP  
 AWARD SOFTWARE, INC.

ACPI function	: Enabled	Primary INTR	: ON
Power Management	: User Define	IRQ3 (COM 2)	: Primary
PM Control by APM	: Yes	IRQ4 (COM 1)	: Primary
Video off Method	: V/H SYNC+Blank	IRQ5 (LPT 2)	: Primary
Video off After	: Suspend	IRQ6 (Floppy Disk)	: Disabled
MODEM Use IRQ	: 3	IRQ7 (LPT 1)	: Primary
Doze Mode	: Disable	IRQ8 (RTC Alarm)	: Disabled
Suspend Mode	: Disable	IRQ9 (IRQ2 Redir)	: Primary
HDD Power Down	: Disable	IRQ10(Reserved)	: Primary
Soft-off by PWRBTN	: Delay 4 Sec	IRQ11(Reserved)	: Primary
PWRON After PW-Fail	: Former-Status	IRQ12(PS/2 Mouse)	: Primary
** PM Events **		IRQ13 (CoPro)	: Disabled
VGA	: OFF	IRQ14 (HDD)	: Disabled
LPT & COM	: LPT/COM	IRQ15 (Rsv)	: Disabled
HDD & FDD	: NO		
DMA/master	: OFF	Esc : Quit	↑ ↓ → ← : Select Item
RTC Alarm Resume	: Disabled	F1 : Help	PU/PD/+/- : Modify
		F5 : Old Values	(Shift) F2 : Color
Modem Ring Resume	: Disabled	F7 : Load Setup Defaults	

Figure 5: Power Management Setup

You can only change the content of Doze Mode, Standby Mode, and Suspend Mode when the Power Management is set to ‘User Define’.

**Power Management:** Use this to select your Power Management selection. The default is User define.

**Disabled:** The system operates in NORMAL conditions (Non-GREEN), and the Power Management function is disabled.

**Max. saving:** Maximum power savings. Inactivity period is 1 minute in each mode.

**Min. saving:** Minimum power savings. Inactivity period is 1 hour in each mode.

**User define:** Allows user to define PM Timers parameters to control power saving mode.

**PM controlled APM:** This option shows whether or not you want the Power Management to be controlled by the Advanced Power Management (APM). The default is Yes.

*Yes: APM controls your PM*

*No: APM does not control your PM*

**Video Off Method:** This option allows you to select how the video will be disabled by the power management.

The default is V/H Sync + Blank

*V/H Sync + Blank: System turns off vertical and horizontal synchronization ports and writes blanks to the video buffer.*

*DPMS: Select this option if your monitor supports the Display Power Management Signaling (DPMS) standard of the Video Electronics Standards Association (VESA). Use the software supplied for your video subsystem to select video power management values.*

*Blank Screen: System only writes blanks to the video buffer.*

**MODEM Use IRQ:** Name the interrupt request (IRQ) line assigned to the modem (if any) on your system. Activity of the selected IRQ always awakens the system.

Default is IRQ 3.

<i>N/A: No IRQ is used.</i>	<i>3: IRQ 3</i>
<i>4: IRQ 4</i>	<i>5: IRQ 5</i>
<i>7: IRQ 7</i>	<i>9: IRQ 9</i>
<i>10: IRQ 10</i>	<i>11: IRQ 11</i>

The EP-MVP4A supports HDD Power Down, Doze and Standby power saving functions when using the Intel Pentium II Processor.

The default is Disabled

**Doze Mode:** The “Doze” mode timer starts to count when no “PM events” have occurred.

**Suspend Mode:** This function works only when the Pentium II Processor is installed. The timer starts to count when “System Standby” mode timer is timed out and no “PM Events” are occurring. Valid range is from 1 minute up to 1 hour.

**HDD Power Down:** HDD Standby timer can be set from 1 to 15 minute(s).

**Soft-Off by PWR-BTTN:** Use this to select your soft-off function.

The default is Delay 4 sec.

*Instant Off: Turns off instantly.*

*Delay 4 Second* : Turns off after a 4 second delay. If momentary press of button, the system will go into Suspend Mode. Press again to take system out of Suspend Mode.

**PWRON After PW-Fail:** The system will stay off or power on after a power interrupte.

The default is Fomer-Status.

**Fomer-Status:** Stay off or power on depend on system safe shut-down or power fail.

**ON:** System always power on after a power interrupte.

**OFF:** System always stay off after a power interrupte.

**VGA:** When set to *On* (default), any event occurring at a VGA port will awaken a system which has been powered down.

**LPT & COM:** When set to *On* (default), any event occurring at a COM(serial)/LPT (printer) port will awaken a system which has been powered down.

**HDD & FDD:** When set to *On* (default), any event occurring at a hard or floppy drive port will awaken a system which has been powered down.

**DMA/master:** When set to *On* (default), any event occurring to the DMA controller will awaken a system which has been powered down.

**RTA Alarm Resume:** When set to *Enable rta alarm resume*, you could set the date (of month) and timer (hh:mm:ss), any event occurring at will awaken a system which has been powered down.

**Modem Ring Resume:** When set to *Enabled*, any event occurring to the Modem Ring will awaken a system which has been powered down.

**Primary INTR:** When set to *On* (default), any event occurring at will awaken a system which has been powered down.

## 4-5 PNP/PCI Configuration

The PNP/PCI configuration program is for the user to modify the PCI/ISA IRQ signals when various PCI/ISA cards are inserted in the PCI or ISA slots.

**WARNING: Conflicting IRQ's may cause the system to not find certain devices.**

ROM PCI/ISA BIOS(2A5LHPA9)  
 PNP/PCI CONFIGURATION  
 AWARD SOFTWARE, INC.

PNP OS Installed	: No	CPU to PCI Write Buffer	: Enabled
Resources Controlled By	: Auto	PCI Dynamic Bursting	: Enabled
Reset Configuration Data	: Disabled	PCI Master 0 WS Write	: Enabled
		PCI Delay Transaction	: Disabled
		PCI#2 Access #1 Retry	: Disabled
		AGP Master 1 WS Write	: Enabled
		AGP Master 1 WS Read	: Disabled
		Assign IRQ For USB	: Enabled
		Assign IRQ For VGA	: Enabled
		Slot 1 Use IRQ No.	: Auto
		Slot 2 Use IRQ No.	: Auto
		Slot 3 Use IRQ No.	: Auto
		Slot 4 Use IRQ No.	: Auto
Esc : Quit		↑ ↓ → ← : Select Item	
F1 : Help		PU/PD/+/- : Modify	
F5 : Old Values		(Shift) F2 : Color	
F7 : Load Setup Defaults			

Figure 6: PCI Configuration Setup

**PNP OS Installed:** Do you have a PNP OS installed on your system. The default is No.

- Yes:* Select if you are using a PNP OS
- No:* Select if your OS does not support PNP.

**Resources Controlled By:** Who controlled the system PNP/PCI resources. The default is Manual.

*Manual:* PNP Card's resources will be controlled manually. You can set which IRQ-X and DMA-X are assigned to PCI/ISA PNP or Legacy ISA Cards.

*Auto:* If your ISA card and PCI card are all PNP cards, BIOS will assign the interrupt resource automatically.

**Reset Configuration Data:** This setting allows you to clear ESCD data. The default is Disabled

*Disabled: Normal Setting.*

*Enabled: If you have plugged in some Legacy cards to the system and they were recorded into ESCD (Extended System Configuration Data), you can set this field to Enabled in order to clear ESCD.*

**CPU to PCI Write Buffer:** When enabled, up to four D words of data can be written to the PCI bus without interrupting the CPU. When disabled, a write buffer is not used and the CPU read cycle will not be completed until the PCI bus signals that it is ready to receive the data.

The Choice: Enabled, Disabled.

**PCI Dynamic Bursting:** When Enabled, data transfers on the PCI bus, where possible, make use of the high-performance PCI burst protocol, in which greater amounts of data are transferred at a single command.

The Choice: Enabled, Disabled.

**PCI Master 0 WS Write:** When Enabled, writes to the PCI bus are command with zero wait states.

The Choice: Enabled, Disabled.

**PCI Delay Transaction:** The chipset has an embedded 32-bit posted write buffer to support delay transactions cycles. Select Enabled to support compliance with PCI specification version 2.1.

The Choice: Enabled, Disabled.

**PCI #2 Access #1 Retry:** This item allows you enabled/disable the PCI #2 Access #1 Retry.

The Choice: Enabled, Disabled.

**Assign IRQ For USB:** This item allows BIOS to assign whether IRQ is with USB or not. If you have not connect the USB device. Can release the IRQ for other device.

The default is Enabled.

*Enabled: Provides IRQ for USB device.*

*Disabled: Release IRQ for other device.*

## 4-6 Load Setup Defaults

The “LOAD SETUP DEFAULTS” function loads the system default data directly from ROM and initializes the associated hardware properly. This function will be necessary only when the system CMOS data is corrupted.

## 4-7 Integrated Peripherals

ROM PCI/ISA BIOS(2A5LHPA9)  
 INTEGRATED PERIPHERALS  
 AWARD SOFTWARE, INC.

OnChip IDE Channel0	: Enabled	Onboard Parallel Mode	: ECP/EPP
OnChip IDE Channel1	: Enabled	ECP Mode Use DMA	: 3
IDE Prefetch Mode	: Enabled	Parallel Port EPP Type	: EPP1.9
IDE HDD Block Mode	: Enabled	Onboard Legacy Audio	: Disabled
Primary Master PIO	: Auto		
Primary Slave PIO	: Auto		
Secondary Master PIO	: Auto		
Secondary Slave PIO	: Auto		
Primary Master UDMA	: Auto		
Primary Slave UDMA	: Auto		
Secondary MasterUDMA	: Auto		
Secondary Slave UDMA	: Auto		
Onboard FDD Controller	: Enabled		
Onboard Serial Port 1	: Auto		
Onboard Serial Port 2	: Auto		
UART 2 Mode	: Standard		
Onboard Parallel Port	: 378/IRQ7		
		Esc : Quit	↑ ↓ → ← : Select Item
		F1 : Help	PU/PD/+/- : Modify
		F5 : Old Values	(Shift) F2 : Color
		F7 : Load Setup Defaults	

Figure 8: Integrated Peripherals

**Note:** *If you do not use the Onboard IDE connector, then you will need to set Onboard Primary PCI IDE: Disabled and Onboard Secondary PCI IDE: Disabled*

**Note:** *The Onboard PCI IDE cable should be equal to or less than 18 inches (45 cm.).*

**IDE Prefetch Mode:** Enable prefetching for IDE drive interfaces that support its faster drive accesses. If you are getting disk drive errors, change the setting to omit the drive interface where the errors occur. Depending on the configuration of your IDE subsystem, this field may not appear, and it does not appear when the Internal PCI/IDE field, above, is Disabled.

The Choice: Enabled, Disabled.

**IDE HDD Block Mode:** IDE Block Mode allows the controller to access blocks of sectors rather than a single sector at a time.

The default is Enabled.

*Enabled:* Enabled IDE HDD Block Mode. Provides higher HDD transfer rates.

*Disabled:* Disable IDE HDD Block Mode.

**Onchip IDE Channel:** The default value is Enabled.

*Enabled:* Enables Onboard IDE primary port.

*Disabled:* Disables Onboard IDE primary port.

**Onchip IDE Channel:**

The default is Enabled.

*Enabled:* Enables Onboard IDE secondary port.

*Disabled:* Disables Onboard IDE secondary port.

**Primary Master PIO**

The default is Auto.

*Auto:* BIOS will automatically detect the Onboard Primary Master PCI IDE HDD Accessing mode.

*Mode 0~4:* Manually set the IDE Programmed interrupt mode.

**Primary Slave PIO**

The default is Auto.

*Auto:* BIOS will automatically detect the Onboard Primary Slave PCI IDE HDD Accessing mode.

*Mode 0~4:* Manually set the IDE Programmed interrupt mode.

**Secondary Master PIO:**

The default is Auto.

*Auto:* BIOS will automatically detect the Onboard Secondary Master PCI IDE HDD Accessing mode.

*Mode 0~4:* Manually set the IDE Programmed interrupt mode.

**Secondary Slave PIO:**

The default is Auto.

*Auto:* BIOS will automatically detect the Onboard Secondary Slave PCI IDE HDD Accessing mode.

*Mode 0~4:* Manually set the IDE Programmed interrupt mode.

**Primary Master UDMA:** This allows you to select the mode of operation for the hard drive.

The default is Auto.

*Auto:* The computer will select the optimal setting.

*Disabled:* The hard drive will run in normal mode.

**Primary Slave UDMA:** This allows you to select the mode of operation for the hard drive.

The default is Auto.

*Auto:* The computer will select the optimal setting.

*Disabled:* The hard drive will run in normal mode.

**Secondary Master UDMA:** This allows you to select the mode of operation for the hard drive.

The default is Auto.

*Auto:* The computer will select the optimal setting.

*Disabled:* The hard drive will run in normal mode.

**Secondary Slave UDMA:** This allows you to select the mode of operation for the hard drive.

The default is Auto.

*Auto:* The computer will select the optimal setting.

*Disabled:* The hard drive will run in normal mode.

**Onboard FDD Controller:** This controls the state of the onboard floppy controller.

The default value is Enabled.

*Enabled:* Enable the Onboard floppy drive interface controller.

*Disabled:* Disable the Onboard floppy drive interface controller.

**Onboard Serial Port 1:** This field allows the user to configure the 1st serial port.

The default is Auto.

*AUTO:* Enable Onboard Serial port 1 and address is Auto adjusted

*COM1:* Enable Onboard Serial port 1 and address is 3F8H/IRQ4.

*COM2:* Enable Onboard Serial port 1 and address is 2F8H/IRQ3.

*COM3:* Enable Onboard Serial port 1 and address is 3E8H/IRQ4.



*COM4: Enable Onboard Serial port 1 and address is 2E8H/IRQ3.*

*Disabled: Disable Onboard Serial port 1.*

**Onboard Serial Port 2:** This field allows the user to configure the 2nd serial port. The default is Auto.

*AUTO: Enable Onboard Serial port 2 and address is Auto adjusted*

*COM1: Enable Onboard Serial port 2 and address is 3F8H/IRQ4.*

*COM2: Enable Onboard Serial port 2 and address is 2F8H/IRQ3.*

*COM3: Enable Onboard Serial port 2 and address is 3E8H/IRQ4.*

*COM4: Enable Onboard Serial port 2 and address is 2E8H/IRQ3.*

*Disabled: Disable Onboard Serial port 2.*

**UART 2 Mode:** This item allows you to determine which Infra Red (IR) function of onboard I/O chip.

The Choice: Standard, ASKIR, HPSIR.

**Onboard Parallel port:** This field allows the user to configure the LPT port. The default is 378H / IRQ7.

*378H: Enable Onboard LPT port and address is 378H and IRQ7.*

*278H: Enable Onboard LPT port and address is 278H and IRQ5.*

*3BCH: Enable Onboard LPT port and address is 3BCH and IRQ7.*

*Disabled: Disable Onboard LPT port.*

**Onboard Parallel Mode:** This field allows the user to select the parallel port mode. The default is ECP+EPP.

*Normal: Standard mode. IBM PC/AT Compatible bidirectional parallel port.*

*EPP: Enhanced Parallel Port mode.*

*ECP: Extended Capabilities Port mode.*

*EPP+ECP: ECP Mode & EPP Mode.*

**ECP Mode USE DMA:** This field allows the user to select DMA1 or DMA3 for the ECP mode.

The default is DMA3.

*DMA1: This field selects the routing of DMA1 for the ECP mode.*

*DMA3: This field selects the routing of DMA3 for the ECP mode.*

**Parallel Port EPP Type:** This item allows you to determine the IR transfer mode of onboard I/O chip.

The Choice: EPP1.9, EPP1.7.

## 4-9 SENSOR AND CPU SPEED SETUP

ROM PCI/ISA BIOS(2A5LHPA9)  
 SENSOR AND CPU SPEED SETUP  
 AWARD SOFTWARE, INC.

Auto Detect DIMM/PCI Clk	: Enabled	Current CPU Temp.	: 35°C/95°F
Spread Spectrum	: Disabled	Current System Temp.	: 26°C/78°F
CPU Host Clock (CPU/PCI)	: Default	Current CPU Fan Speed	: 5080 RPM
CPU Fan In Suspend	: Off	Current Chassis Fan Speed	: 0 RPM
		Vcore	: 2.46V      2.5V : 2.57V
		3.3V	: 3.58V      5V : 5.15V
		12V	: 12.12V
		Esc : Quit	↑ ↓ → ← : Select Item
		F1 : Help	PU/PD/+/- : Modify
		F5 : Old Values	(Shift) F2 : Color
		F7 : Load Setup Defaults	

Figure 9: Sensor And CPU Speed Setup

**Auto Detect DIMM/PCI Clk:** When enabled the motherboard will automatically disable the clock source for a DIMM socket which does not have a module in it. Same applies for PCI slots.  
 The default is Enabled.

- Enabled:* Enables this option.
- Disabled:* Disables this option.

**Spread Spectrum :**

The default is Disabled.

- Enabled:* Enables this option.
- Disabled:* Disables this option.

**CPU Host Clock (CPU/PCI):** Allows the external clock to be modified depending upon what FSB has been selected. Should not be used to clock processor faster than it was designed for. (See page A-11).  
 The default is Default.

*66MHz FSB options: Default, 66.8, 68.5, 75, and 83MHz.*

*100MHz FSB options: Default, 100, 103, 112, and 133MHz.*

**CPUFAN Off In Suspend:** This option is used to set if the CPU fans will turn off during suspend mode.

The default is Enabled.

*Enabled: The system will turn off the CPU fans during suspend mode.*

*Disabled: The system will not turn off the CPU fan during suspend mode.*

**Current System Temp:** This is the Current temperature of the system.

**Current CPU Temperature:** This is the current temperature of the CPU.

**Current CPU FAN Speed:** The current CPU fan speed in RPMs.

**Current Chassis FAN Speed:** The current chassis fan speed in RPMs.

**CPU(V):** The voltage level of the CPU(Vio/Vcore).

**+2.5V, +3.3V, +5V, +12V:** The voltage level of the switch power supply.

## **4-8 Change Supervisor or User Password**

---

To change the password, choose the “SUPERVISOR PASSWORD or USER PASSWORD” option from the CMOS SETUP UTILITY menu and press [Enter].

*NOTE: Either “Setup” or “System” must be selected in the “Security Option” of the BIOS FEATURES SETUP menu.*

1. If CMOS is corrupted or the option was not used, a default password stored in the ROM will be used. The screen will display the following message:

Enter Password:

Press the [Enter] key to continue after the proper password is given.

2. If the CMOS is corrupted or the option was used earlier and the user wishes to change the default password, the SETUP UTILITY will display a message and ask for a confirmation.

Confirm Password:

- After pressing the [Enter] key (ROM password if the option was not used) or current password (user-defined password), the user can change the password and store new one in CMOS RAM. A maximum of 8 characters can be entered.

### 4-9 IDE HDD Auto Detection

The “IDE HDD auto detection” utility is a very useful tool, especially when you do not know which kind of hard disk type you are using. You can use this utility to detect the correct disk type installed in the system automatically. But now you can set HARD DISK TYPE to Auto in the STANDARD CMOS SETUP. You don’t need the “IDE HDD AUTO DETECTION” utility. The BIOS will Auto-detect the hard disk size and model on display during POST.

ROM PCI/ISA BIOS(2A5LHPA9)  
 CMOS SETUP UTILITY  
 AWARD SOFTWARE, INC.

HARD DISKS	TYPE	SIZE	CYLS	HEADS	PRECOMP	LANDZONE	SECTORS	MODE
Primary Master :								
Select Secondary Slave Option (N=Skip) : N								
OPTIONS	SIZE	CYLS	HEAD	PRECOMP	LANDZ	SECTOR	MODE	
2 (Y)	4310	524	255	0	14847	63	LBA	
1	4310	14848	9	65535	14847	63	NORMAL	
3	4310	928	144	65535	14847	63	LARGE	
Note: Some OSes (like SCO-UNIX) must use NORMAL for installation								
ESC : Skip								

Figure 10: IDE HDD Auto Detection

**NOTE: HDD Modes**

The Award BIOS supports 3 HDD modes : NORMAL, LBA & LARGE NORMAL mode

Generic access mode in which neither the BIOS nor the IDE controller will make any transformations during accessing.

The maximum number of cylinders, head & sectors for NORMAL mode are.

1024, 16 & 63  
 no. Cylinder (1024)  
 x no. Head ( 16)  
 x no. Sector ( 63)  
x no. per sector (512)  
 528 Megabytes

If user set his HDD to NORMAL mode, the maximum accessible HDD size will be 528 Megabytes even though its physical size may be greater than that!

**LBA (Logical Block Addressing) mode:** A new HDD accessing method to overcome the 528 Megabyte bottleneck. The number of cylinders, heads & sectors shown in setup may not be the number physically contained in the HDD. During HDD accessing, the IDE controller will transform the logical address described by sector, head & cylinder into its own physical address inside the HDD. The maximum HDD size supported by LBA mode is 8.4 GigaBytes which is obtained by the following formula:

no. Cylinder (1024)  
 x no. Head ( 255)  
 x no. Sector ( 63)  
x bytes per sector (512)  
 8.4 GigaBytes

**LARGE mode:** Extended HDD access mode supported by Award Software.

Some IDE HDDs contain more than 1024 cylinder without LBA support (in some cases, user do not want LBA). The Award BIOS provides another alternative to support these kinds of LARGE mode.

<u>CYLS</u>	<u>HEADS</u>	<u>SECTOR</u>	<u>MODE</u>
1120	16	59	NORMAL
560	32	59	LARGE

BIOS tricks DOS (or other OS) that the number of cylinders is less than 1024 by dividing it by 2. At the same time, the number of heads is multiplied by 2. A reverse transformation process will be made inside

INT 12h in order to access the right HDD address!

**Maximum HDD size:**

no. Cylinder	(1024)
x no. Head	( 32)
x no. Sector	( 63)
<u>x bytes per sector</u>	<u>( 512)</u>
	1 GigaByte

*Note: To support LBA or LARGE mode of HDDs, there must be some software involved. All the software is located in the Award HDD Service Routine (INT 13h). It may fail to access a HDD with LBA (LARGE) mode selected if you are running under an Operating System which replaces the whole INT 13h.*

UNIX operating systems do not support either LBA or LARGE and must utilize the Standard mode. UNIX can support drives larger than 528MB.

---

**4-10 HDD Low Level Format**

---

**Interleave:** Select the interleave number of the hard disk drive you wish to perform a low level format on. You may select from 1 to 8. Check the documentation that came with the drive for the correct interleave number, or select 0 for automatic detection.

**Auto scan bad track:** This allows the utility to scan first then format by each track.

**Start:** Press<Y>to start low level format.

---

**4-11 Save & Exit Setup**

---

The “SAVE & EXIT SETUP” option will bring you back to the boot up procedure with all the changes you just recorded in the CMOS RAM.

---

**4-12 Exit Without Saving**

---

The “EXIT WITHOUT SAVING” option will bring you back to normal boot up procedure without saving any data into CMOS RAM.

**All old data in the CMOS will not be destroyed.**

---

## Appendix A

---

### A-1 MEMORY MAP

---

Address Range	Size	Description
[00000-7FFFF]	512K	Conventional memory
[80000-9FBFF]	127K	Extended Conventional memory
[9FC00-9FFFF]	1K	Extended BIOS data area if PS/2 mouse is installed
[A0000-C7FFF]	160K	Available for Hi DOS memory
[C8000-DFFFF]	96K	Available for Hi DOS memory and adapter ROMs
[E0000-EEFFF]	60K	Available for UMB
[EF000-EFFFF]	4K	Video service routine for Monochrome & CGA adaptor
[F0000-F7FFF]	32K	BIOS CMOS setup utility
[F8000-FCFFF]	20K	BIOS runtime service routine (2)
[FD000-FDFFF]	4K	Plug and Play ESCD data area
[FE000-FFFFF]	8K	BIOS runtime service routine (1)

### A-2 I/O MAP

---

[000-01F]	DMA controller.(Master)
[020-021]	INTERRUPT CONTROLLER.(Master)
[022-023]	CHIPSET control registers. I/O ports.
[040-05F]	TIMER control registers.
[060-06F]	KEYBOARD interface controller.(8042)
[070-07F]	RTC ports & CMOS I/O ports.
[080-09F]	DMA register.
[0A0-0BF]	INTERRUPT controller.(Slave)
[0C0-0DF]	DMA controller.(Slave)
[0F0-0FF]	MATHCOPROCESSOR.
[1F0-1F8]	HARD DISK controller.
[278-27F]	PARALLEL port 2.
[2B0-2DF]	GRAPHICS adapter controller.
[2F8-2FF]	SERIAL port 2.
[360-36F]	NETWORK ports.
[378-37F]	PARALLEL port 1.
[3B0-3BF]	MONOCHROME & PARALLEL port adapter.
[3C0-3CF]	EGA adapter.

[3D0-3DF]	CGA adapter.
[3F0-3F7]	FLOPPY DISK controller.
[3F8-3FF]	SERIAL port 1.

### **A-3 TIMER & DMA CHANNELS MAP**

#### TIMER MAP:

TIMER Channel 0	System timer interrupt.
TIMER Channel 1	DRAM REFRESH request.
TIMER Channel 2	SPEAKER tone generator.

#### DMA CHANNELS:

DMA Channel 0	Available.
DMA Channel 1	Onboard ECP (Option).
DMA Channel 2	FLOPPY DISK (SMC CHIP).
DMA Channel 3	Onboard ECP (default).
DMA Channel 4	Cascade for DMA controller 1.
DMA Channel 5	Available.
DMA Channel 6	Available.
DMA Channel 7	Available

### **A-4 INTERRUPT MAP**

#### NMI :

Parity check error.

#### IRQ (H/W):

0	System TIMER interrupt from TIMER 0.
1	KEYBOARD output buffer full.
2	Cascade for IRQ 8-15.
3	SERIAL port 2.
4	SERIAL port 1.
5	PARALLEL port 2.
6	FLOPPY DISK (SMC CHIP).
7	PARALLEL port 1.
8	RTC clock.
9	Available.
10	Available.
11	Available.
12	PS/2 Mouse.
13	MATH coprocessor.

---



- 14 Onboard HARD DISK (IDE1) channel.
- 15 Onboard HARD DISK (IDE1) channel.

## **A-5 RTC & CMOS RAM MAP**

---

### RTC & CMOS:

- 00 Seconds.
- 01 Second alarm.
- 02 Minutes.
- 03 Minutes alarm.
- 04 Hours.
- 05 Hours alarm.
- 06 Day of week.
- 07 Day of month.
- 08 Month.
- 09 Year.
- 0A Status register A.
- 0B Status register B.
- 0C Status register C.
- 0D Status register D.
- 0E Diagnostic status byte.
- 0F Shutdown byte.
- 10 FLOPPY DISK drive type byte.
- 11 Reserve.
- 12 HARD DISK type byte.
- 13 Reserve.
- 14 Equipment type.
- 15 Base memory low byte.
- 16 Base memory high byte.
- 17 Extension memory low byte.
- 18 Extension memory high byte.
- 19-2d
- 2E-2F
- 30 Reserved for extension memory low byte.
- 31 Reserved for extension memory high byte.
- 32 DATE CENTURY byte.
- 33 INFORMATION FLAG.
- 34-3F Reserve.
- 40-7F Reserved for CHIPSET SETTING DATA.

---

**Page Left Blank**

---

---

**Appendix B**

---

**B-1 POST CODES**

---

ISA POST codes are typically output to I/O port address 80h.

<b>POST (hex)</b>	<b>DESCRIPTION</b>
01-02	Reserved.
C0	Turn off OEM specific cache, shadow.
03	<ol style="list-style-type: none"> <li>1. Initialize EISA registers (EISA BIOS only).</li> <li>2. Initialize all the standard devices with default values</li> </ol> Standard devices includes. <ul style="list-style-type: none"> <li>- DMA controller (8237).</li> <li>- Programmable Interrupt Controller (8259).</li> <li>- Programmable Interval Timer (8254).</li> <li>- RTC chip.</li> </ul>
04	Reserved
05	<ol style="list-style-type: none"> <li>1. Keyboard Controller Self-Test.</li> </ol>
06	<ol style="list-style-type: none"> <li>2. Enable Keyboard Interface.</li> </ol>
07	Reserved.
08	Verifies CMOS's basic R/W functionality.
C1	Auto-detection of onboard DRAM & Cache.
C5	Copy the BIOS from ROM into E0000-FFFFFF shadow RAM so that POST will go faster.
08	Test the first 256K DRAM.
09	OEM specific cache initialization. (if needed)
0A	<ol style="list-style-type: none"> <li>1. Initialize the first 32 interrupt vectors with corresponding Interrupt handlers. Initialize INT numbers from 33-120 with Dummy (Spurious) Interrupt Handler.</li> <li>2. Issue CPUID instruction to identify CPU type.</li> <li>3. Early Power Management initialization. (OEM specific)</li> </ol>
0B	<ol style="list-style-type: none"> <li>1. Verify the RTC time is valid or not.</li> <li>2. Detect bad battery.</li> <li>3. Read CMOS data into BIOS stack area.</li> <li>4. PnP initializations including. (PnP BIOS only)               <ul style="list-style-type: none"> <li>- Assign CSN to PnP ISA card.</li> <li>- Create resource map from ESCD.</li> </ul> </li> </ol>

---

	5. Assign IO & Memory for PCI devices. (PCI BIOS only)
0C	Initialization of the BIOS Data Area. (40:0N - 40:FF)
0D	1. Program some of the Chipset's value according to Setup. (Early Setup Value Program) 2. Measure CPU speed for display & decide the system clock speed. 3. Video initialization including Monochrome, CGA, EGA/VGA. If no display device found, the speaker will beep.
0E	1. Test video RAM. (If Monochrome display device found) 2. Show messages including. <ul style="list-style-type: none"><li>- Award Logo, Copyright string, BIOS Data code &amp; Part No.</li><li>- OEM specific sign on messages.</li><li>- Energy Star Logo. (Green BIOS ONLY)</li><li>- CPU brand, type &amp; speed.</li><li>- Test system BIOS checksum. (Non-Compress Version only)</li></ul>
0F	DMA channel 0 test.
10	DMA channel 1 test.
11	DMA page registers test.
12-13	Reserved.
14	Test 8254 Timer 0 Counter 2.
15	Test 8259 interrupt mask bits for channel 1.
16	Test 8259 interrupt mask bits for channel 2.
17	Reserved.
19	Test 8259 functionality.
1A-1D	Reserved.
1E	If EISA NVM checksum is good, execute EISA initialization. (EISA BIOS only)
1F-29	Reserved.
30	Detect Base Memory & Extended Memory Size.
31	1. Test Base Memory from 256K to 640K. 2. Test Extended Memory from 1M to the top of memory.
32	1. Display the Award Plug & Play BIOS Extension message. (PnP BIOS only) 2. Program all onboard super I/O chips (if any) including COM ports, LPT ports, FDD port ... according to setup value.
33-3B	Reserved.
3C	Set flag to allow users to enter CMOS Setup Utility.
3D	1. Initialize Keyboard.

---

- 
2. Install PS2 mouse.
- 3E Try to turn on Level 2 cache.  
**Note:** Some chipset may need to turn on the L2 cache in this stage. But usually, the cache is turn on later in POST 61h.
- 3F-40 Reserved.
- BF 1. Program the rest of the Chipset's value according to Setup. (Later Setup Value Program)
- 41 2. If auto-configuration is enabled, program the chipset with pre-defined Values.
- 42 Initialize floppy disk drive controller.
- 43 Initialize Hard drive controller.
- 45 If it is a PnP BIOS, initialize serial & parallel ports.
- 44 Reserved.
- 45 Initialize math coprocessor.
- 46-4D Reserved.
- 4E If there is any error detected (such as video, kb...), show all error messages on the screen & wait for user to press <F1> key.
- 4F 1. If password is needed, ask for password.  
2. Clear the Energy Star Logo. (Green BIOS only)
- 50 Write all CMOS values currently in the BIOS stack area back into the CMOS.
- 51 Reserved.
- 52 1. Initialize all ISA ROMs.  
2. Later PCI initializations. (PCI BIOS only)  
- assign IRQ to PCI devices.  
- initialize all PCI ROMs.  
3. PnP Initializations. (PnP BIOS only)  
- assign IO, Memory, IRQ & DMA to PnP ISA devices.  
- initialize all PnP ISA ROMs.  
4. Program shadows RAM according to Setup settings.  
5. Program parity according to Setup setting.  
6. Power Management Initialization.  
- Enable/Disable global PM.  
- APM interface initialization.
- 53 1. If it is NOT a PnP BIOS, initialize serial & parallel ports.  
2. Initialize time value in BIOS data area by translate the RTC time value into a timer tick value.
- 60 Setup Virus Protection. (Boot Sector Protection) functionality
-

	according to Setup setting.
61	<ol style="list-style-type: none"> <li>1. Try to turn on Level 2 cache.</li> </ol> <p>Note: If L2 cache is already turned on in POST 3D, this part will be skipped.</p> <ol style="list-style-type: none"> <li>2. Set the boot up speed according to Setup setting.</li> <li>3. Last chance for Chipset initialization.</li> <li>4. Last chance for Power Management initialization. (Green BIOS only)</li> <li>5. Show the system configuration table.</li> </ol>
62	<ol style="list-style-type: none"> <li>1. Setup daylight saving according to Setup value.</li> <li>2. Program the NUM Lock, typematic rate &amp; typematic speed according to Setup setting.</li> </ol>
63	<ol style="list-style-type: none"> <li>1. If there is any changes in the hardware configuration, update the ESCD information. (PnP BIOS only)</li> <li>2. Clear memory that have been used.</li> <li>3. Boot system via INT 19H.</li> </ol>
FF	System Booting. This means that the BIOS already pass the control right to the operating system.

## **B-2 Unexpected Errors:**

---

<b>POST (hex)</b>	<b>DESCRIPTION</b>
B0	If interrupt occurs in protected mode.
B1	Unclaimed NMI occurs.0

Appendix C

NOTE:

The "LOAD SETUP DEFAULTS" function loads the system default data directly from ROM and initializes the associated hardware properly. This function will be necessary when you accept this mainboard, or the system CMOS data is corrupted.

ROMPCI/ISA BIOS(2A5LHPA9)
CMOS SETUP UTILITY
AWARD SOFTWARE, INC.

STANDARD CMOS SETUP
BIOS FEATURES SETUP
CHIPSET FEATURES SETUP
POWER MANAGEMENT SETUP
PNP/PCI CONFIGURATION
INTEGRATED PERIPHERALS
LOAD SETUP DEFAULTS
SENSOR AND CPU SPEED SETUP
SUPERVISOR PASSWORD
USER PASSWORD
IDE HDD AUTO DETECTION
LOAD SETUP Default (Y/N)? Y
ESC: QUIT
F10: Save & Exit Setup
Load Setup Defaults Except Standard COMS SETUP

LOAD SETUP DEFAULTS

**D-1 Sound Driver Quick Installation Guide***Install windows 95/98 Sound Driver***\*\*Installation Notes:**

You must already have Windows 95/98 install on your computer.

1. Login windows 95/98, then click “My Computer” icon, “Control Panel” icon, and “System” icon.
2. Before the Driver install into windows 95/98, you will find a yellow question mark still exits the “Other Devices” of the “Device Manager” show in Figure 1-1 below.

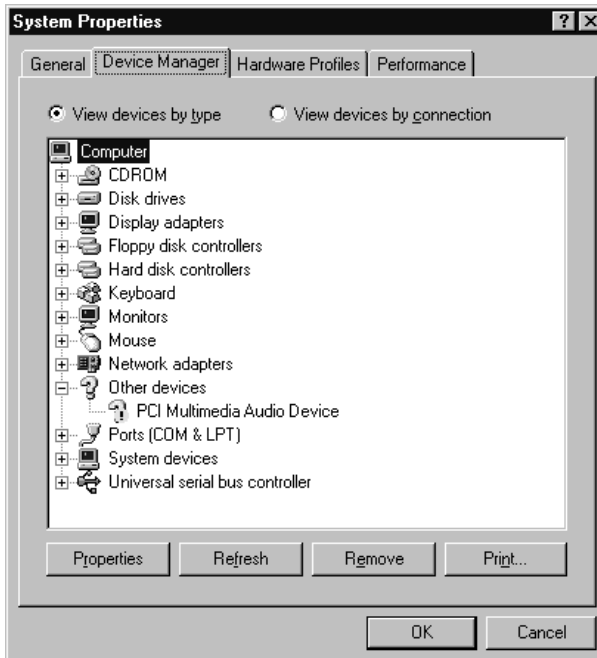

Figure 1



3. Please remove the yellow question mark then click "refresh", windows will detect it's presence and display the following dialog.
4. Click "Next" button, it will find Floppy A:
5. Click "Other Locations" button
6. Key-in the driver location (ex. D:\686Audio\Win95, D:\686Audio\Win98) then click "OK" button (You can use the "Browse" button to find the driver location; if you don't know where the driver is)
7. Click "Finish" button
8. The click "OK" button
9. Re-key in the driver location to the "Copy files from:"(refer step 4) click "ok", the you will be complete to install driver. Remember to restart your computer to take it into effect, show in figure 1-2 below.

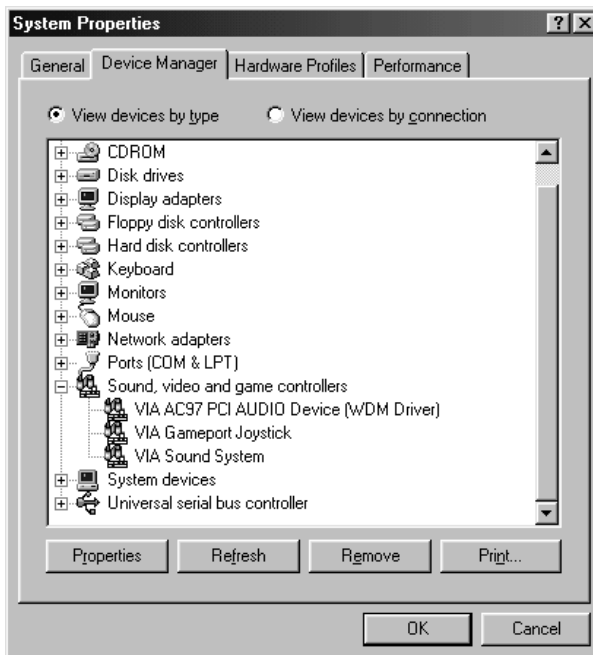

Figure 2

