



EP-MVP3M

**ISA/PCI AGP Mainboard with Onboard
PCI IDE and Super Multi-I/O**

TRADEMARK

All products and company names are trademarks or registered trademarks of their respective holders.

These specifications are subject to change without notice.

*Manual Revision 5.2
October 27, 1999*

User Notice

No part of this product, including the product and software may be reproduced, transmitted, transcribed, stored in a retrieval system, or translated into any language in any form without the express written permission of EPoX Computer Company (hereinafter referred to as EPoX) except for documentation kept by the purchaser for backup purposes.

We provide this manual “as is” without warranty of any kind, either expressed or implied, including but not limited to the implied warranties or conditions of merchantability or fitness for a particular purpose. In no event shall EPoX be liable for any loss of profits, loss of business, loss of use or data, interruption of business or for indirect, special incidental, or consequential damages of any kind, even if EPoX has been advised of the possibility of such damages arising from any defect or error in the manual or product. EPoX may revise this manual from time to time without notice. For updated BIOS, drivers, or product release information you may visit our websites at <http://www.epox.com> or <http://www.epox.com.tw>.

Products mentioned in this manual are mentioned for identification purposes only. Product names appearing in this manual may or may not be registered trademarks or copyrights of their respective companies. **The product name and revision number are both printed on the mainboard itself.**

Handling Procedures

Static electricity can severely damage your equipment. Handle the EP-MVP3M and any other device in your system with extreme care and avoid unnecessary contact with system components on the mainboard. Always work on an antistatic surface to avoid possible damage to the mainboard from static discharge. Always have the power supply unplugged and powered off when inserting and removing devices within the computer chassis. EPoX assumes no responsibility for any damage to the EP-MVP3M mainboard that results from failure to follow instruction or failure to observe safety precautions.



CAUTION



The EP-MVP3M mainboard is subject to damage by static electricity. Always observe the handling procedures.

EP-MVP3M

Technical Support Services

If you need additional information, help during installation or normal use of this product, please contact your retailer. Your retailer will have the most current information about your configuration. If your retailer cannot help, you may visit our online technical support website and/or contact our support technicians at the locations listed below.

Record your serial number before installing your EP-MVP3M mainboard. (The serial number is located near the ISA slots at the edge of the board.)

EP-MVP3M serial number: _____

Contacting Technical Support

EPoX technical support is working hard to answer all of your questions online. From our website you can find answers to many common questions, drivers, BIOS updates, tech notes, and important technical bulletins. If you are still unable to locate the solution you are seeking, you always have the option to contact our support technicians directly.

North American website (English language)

<http://www.epox.com>

sales@epox.com

support@epox.com

European website (Multi-language)

<http://www.epox.nl>

sales@epox.nl

support@epox.nl

Taiwan website (Chinese language)

<http://www.epox.com.tw>

sales@epox.com.tw

support@epox.com.tw

Thank you for using EPoX mainboards!

Copyright 1999 EPoX Computer Company. All rights reserved.

Table of Contents

	<i>Page</i>
<i>Section 1</i>	<i>Introduction</i>
	Components Checklist 1-1
	<i>Overview</i>
	EP-MVP3M Form-factor 1-2
	I/O Shield Connector 1-3
	Power-On/Off (Remote) 1-3
	System Block Diagram 1-4
<i>Section 2</i>	<i>Features</i>
	EP-MVP3M Features 2-1
<i>Section 3</i>	<i>Installation</i>
	EP-MVP3M Detailed Layout 3-2
	<i>Easy Installation Procedure</i>
	Configure Jumpers 3-3
	System Memory Configuration 3-5
	Device Connectors 3-7
<i>Section 4</i>	<i>Award BIOS Setup</i>
	BIOS Instructions 4-1
	Standard CMOS Setup 4-2
	BIOS Features Setup 4-3
	Chipset Features Setup 4-8
	Power Management Setup 4-11
	PNP/PCI Configuration 4-15
	Load Setup Defaults 4-18
	Integrated Peripherals 4-18
	Sensor and CPU Speed Setup 4-23
	Change Supervisor or User Password 4-25

IDE HDD Auto Detection 4-26
Save & Exit Setup 4-28
Exit Without Saving 4-28

Section 5 *Appendix*

Appendix A

Memory Map A-1
I/O Map A-1
Timer & DMA Channels Map A-2
Interrupt Map A-2
RTC & CMOS RAM Map A-3

Appendix B

POST Codes A-5
Unexpected Errors A-8

Appendix C

Load Setup Defaults A-9

Appendix D

GHOST 5.1 Quick User's Guide A-11

Section 1
INTRODUCTION

Components Checklist

- ✓ A. (1) EP-MVP3M mainboard
- ✓ B. (1) EP-MVP3M user's manual
- ✓ C. (1) Floppy ribbon cable
- ✓ D. (1) ATA-66 hard drive ribbon cable
- ✓ E. (1) Driver and utility

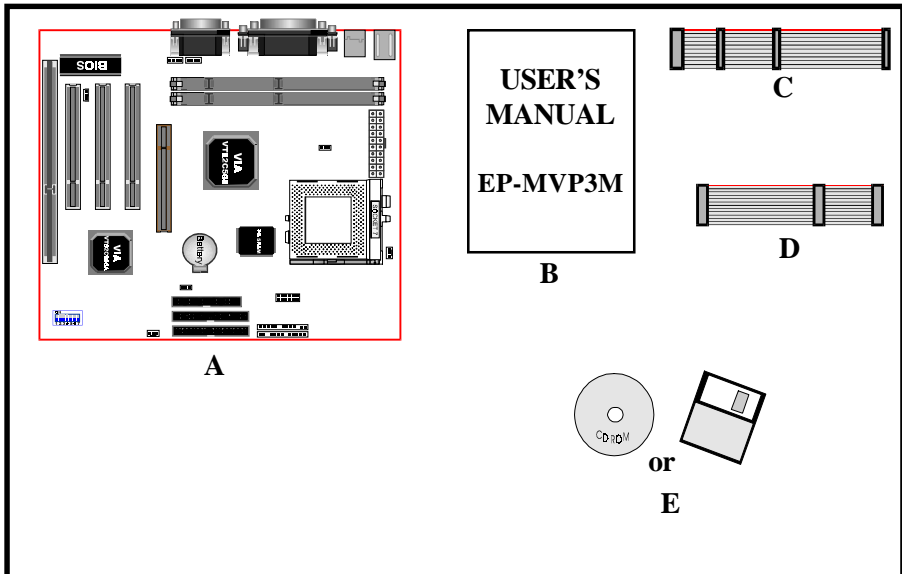

EP-MVP3M Form-Factor

The EP-MVP3M is designed with MicroATX form factor - the new industry standard of chassis. The MicroATX form factor is essentially a Baby-AT base-board rotated 90 degrees within the chassis enclosure and a new mounting configuration for the power supply. With these changes the processor is relocated away from the expansion slots, allowing them all to hold full length add-in cards. MicroATX defines a double height aperture to the rear of the chassis which can be used to host a wide range of onboard I/O. Only the size and position of this aperture is defined, allowing PC manufacturers to add new I/O features (e.g.; TV input, TV output, joystick, modem, LAN, etc.) to systems. This will help systems integrators differentiate their products in the marketplace, and better meet your needs.

- Smaller size promotes a smaller system size.
- I/O shield does not need to be retooled in an ATX 2.01 or later. The Mainboard should be used in an ATX 2.01 (or later) compliant case.
- A smaller power supply can be used. High integration on mainboard reduces the system costs.

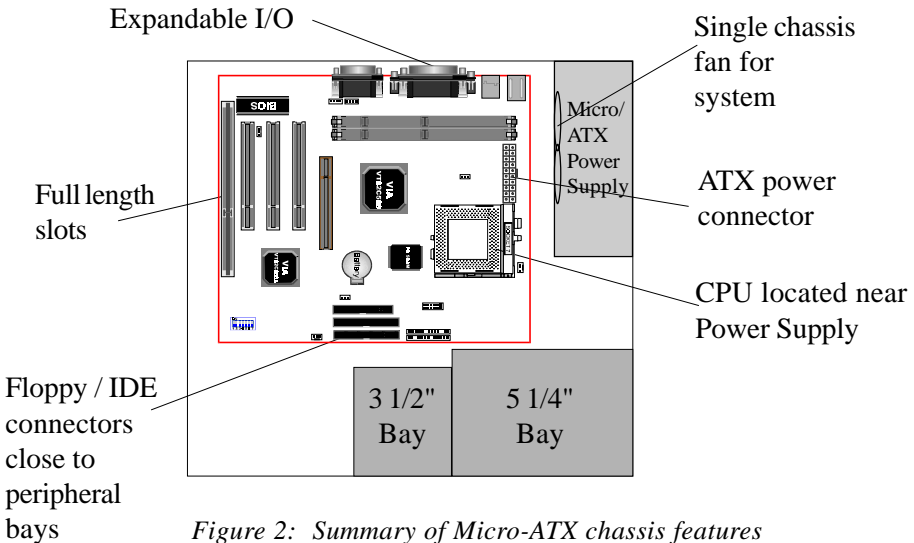

Figure 2: Summary of Micro-ATX chassis features

I/O Shield Connector

The EP-MVP3M is equipped with an I/O back panel. Please use the appropriate I/O shield (figure 3).

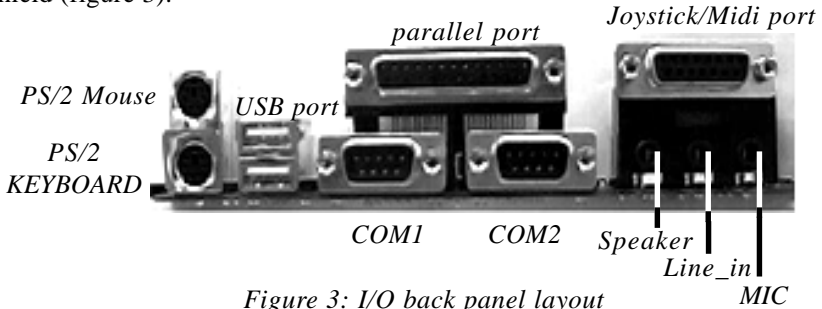

Figure 3: I/O back panel layout

Power-On/Off (Remote)

The EP-MVP3M has a single 20-pin connector for ATX power supplies. For ATX power supplies that support the **Remote On/Off** feature, this should be connected to the systems front panel for system Power On/Off button. The systems power On/Off button should be a momentary button that is normally open.

The EP-MVP3M has been designed with "Soft Off" functions. You can turn Off the system from one of two sources: The first is the front panel Power On/Off button, and the other is the "Soft Off" function (coming from the EP-MVP3M's onboard circuit controller) that can be controlled by the operating system. Windows 95/98 will control this when the user clicks that they are ready to Shutdown the system.

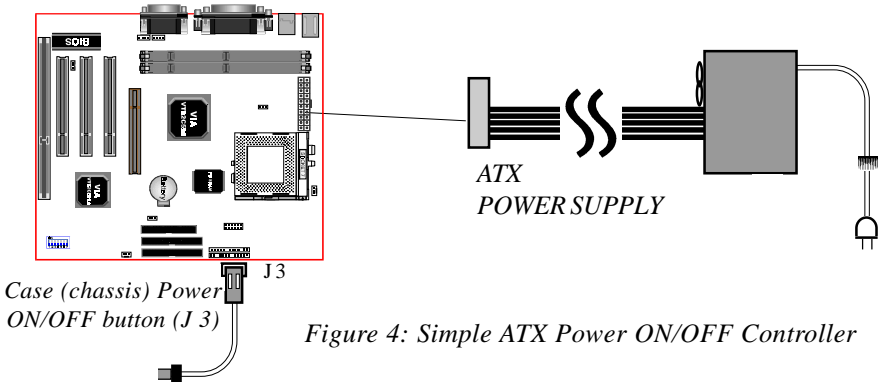

Figure 4: Simple ATX Power ON/OFF Controller

System Block Diagram

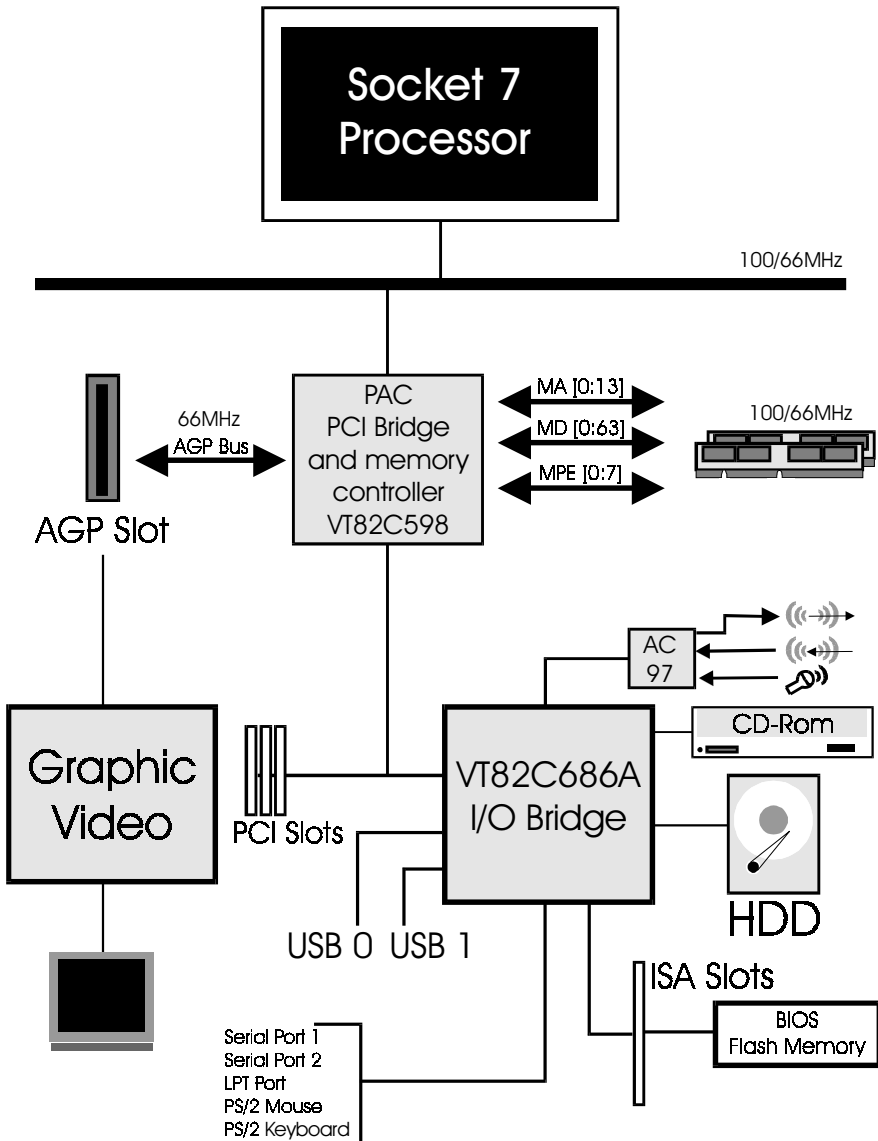

Figure 5: System Block Diagram

Section 2
FEATURES

EP-MVP3M Features:

- Intel **Pentium**® Processor, Pentium Processor with MMX technology, AMD K6/K6-2/K6 III, Cyrix 6x86MX/MII, *idt* C6/Winchip, and Rise mp6 series operating at **133 ~ 500MHz** with **321 ZIF socket 7** provides scalability to accept faster Processors in the future.
- Designed with VIA MVP3 AGPset.
- Supports up to 256MB of DRAM (minimum of 8 MB) on board (please see Section 3-2).
- Supports (1) 16 bit ISA slots, (3) 32 bit PCI slots, (1) AGP slot and provides (2) independent high performance PCI IDE interfaces capable of supporting PIO Mode 3/4 and Ultra DMA 33/66 devices. The EP-MVP3M supports (3) PCI Bus Master slots and a jumperless PCI INT# control scheme which reduces configuration confusion when plugging in PCI card(s).
- Supports ATAPI (e.g. CD-ROM) devices on both Primary and Secondary IDE interfaces.
- Designed with on chip Multi I/O: (1) floppy port, (1) parallel port (EPP, ECP), and (2) serial ports (16550 Fast UART).
Note: Japanese “Floppy 3 mode” is also supported
- Features Award Plug & Play BIOS. With Flash Memory you can always upgrade to the current BIOS as they are released.
- EP-MVP3M utilizes a Lithium battery which provides environmental protection and longer battery life.
- Supports the Universal Serial Bus (USB) Ports. The onboard VT82C686A chip provides the means for connecting PC peripherals such as; keyboards, joysticks, telephones, and modems.

- Built-in ATX 20-pin power supply connector.
- Software power-down when using Windows® 95/98.
- Supports ring-in feature (remote power-on through external modem, allows system to be turned on remotely).
- Resume by Alarm - Allows your system to turn on at a preselected time.
- Power Loss Recovery - In the event of a power outage your system will automatically turn itself back on without user intervention.
- Supports CPU Hardware sleep and SMM (System Management Mode).
- Built-in WOL (Wake-up On Lan) Connector.
- Built-in AC97 PCI Audio.

Section 3 INSTALLATION

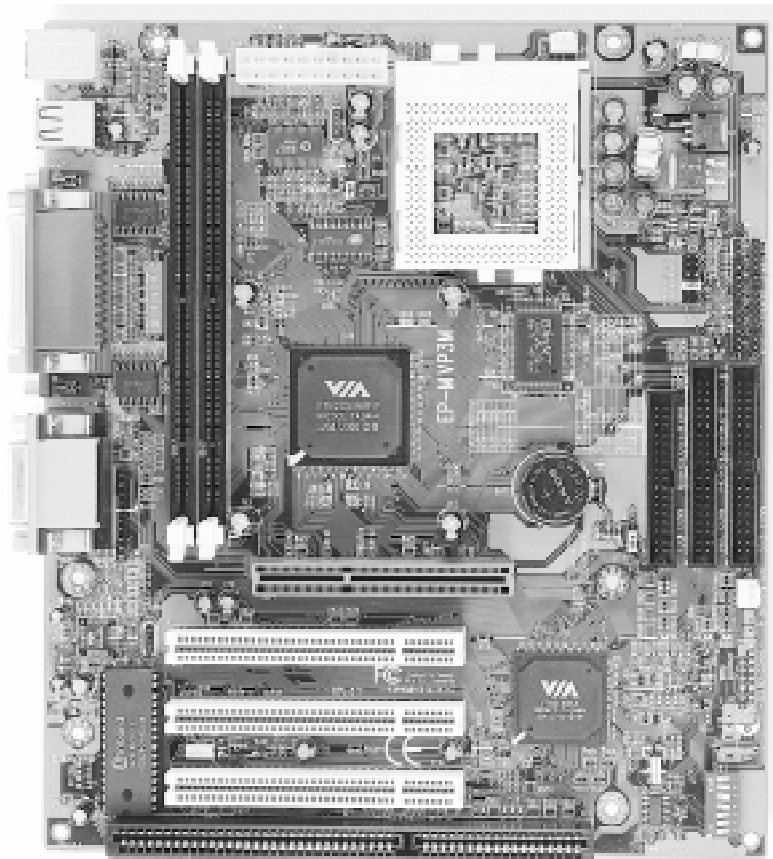

EP-MVP3M Detailed Layout

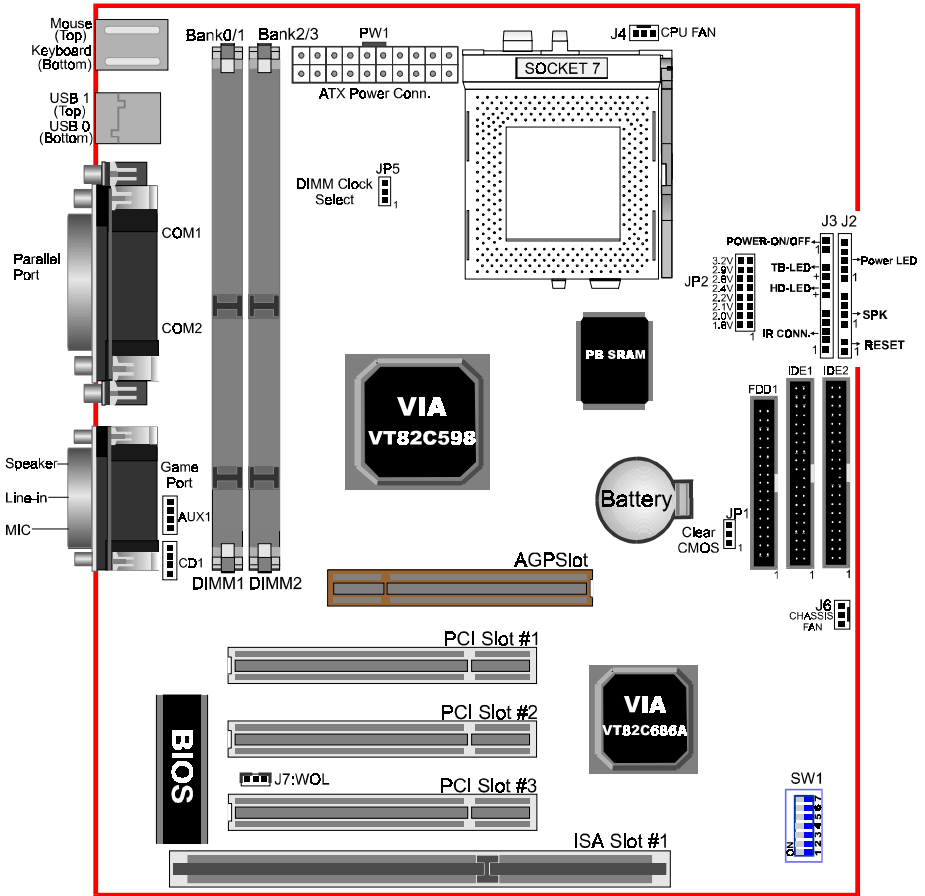

Figure 1

Easy Installation Procedure

Easy Installation Procedure

The following must be completed before powering on your new system:

- 3-1. **Configure Jumpers**
- 3-2. **System memory Configuration**
- 3-3. **Device Connectors**

Section 3-1 Configure Jumpers

We design this motherboard with the fewest jumpers to make your install fast and easy.

The following will describe all of the jumpers that you are required to set before moving on to step 3-2.

Note: The DIP jumpers as depicted as shown (Figure 1) in their correct physical orientation.

JP1  **3** *Clear COMS*
 1-2 : Normal (default)
 2-3 : Clear CMOS

JP5  **3** *DIMM Clock Selection*
 1-2 : DIMM = AGP
 2-3 : DIMM = CPU

J7  *WOL (Wake On Lan) Connector*
 Reserved for NIC (Network Interface Card) to Wake the System.

JP2: CPU Voltage Selection

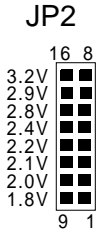

JP2	CPU Vcore
8-16	3.2V
7-15	2.9V
6-14	2.8V
5-13	2.4V
4-12	2.2V
3-11	2.1V
2-10	2.0V
1-9	1.8V

SW1: CPU Speed Selection



CPU Type				SW1							CPU Multiplier	CPU Bus Clock
Pentium/MMX AMD K6/K6-2/K6III IDT-C6	Cyrix /IBM 6x86MX/MII	IDT Winchip 2	Rise MP6	1	2	3	4	5	6	7		
166MHz	PR200			ON	ON			ON	ON		2.5X	66MHz
	PR233			ON	ON				ON			75MHz
	PR266	233MHz		ON	ON			ON				83MHz
	PR300		*PR333	ON	ON		ON			ON		95MHz
250MHz	PR366	300MHz	*PR366	ON	ON					ON	3X	100MHz
200MHz	PR266	200MHz			ON			ON	ON			66MHz
	PR300	225MHz			ON				ON			75MHz
250MHz	PR333	266MHz			ON			ON				83MHz
	PR400		*PR380		ON		ON			ON	95MHz	
300MHz	*PR433		*PR400		ON					ON	100MHz	
233MHz	PR300	233MHz							ON	ON	3.5X	66MHz
	PR333								ON			75MHz
	*PR400								ON			83MHz
333MHz	*PR466		*PR433				ON			ON		95MHz
350MHz	*PR500		*PR466							ON	100MHz	
266MHz	*PR333	266MHz		ON	ON			ON	ON		4X	66MHz
	*PR400			ON	ON				ON			75MHz
333MHz	*PR466			ON	ON			ON				83MHz
380MHz	*PR533			ON	ON	ON				ON		95MHz
400MHz	*PR550			ON	ON					ON	100MHz	
300MHz				ON	ON	ON			ON	ON	4.5X	66MHz
450MHz				ON	ON	ON				ON		100MHz
333MHz								ON	ON		5X	66MHz
475MHz					ON	ON	ON			ON		95MHz
*500MHz		266MHz			ON	ON				ON		100MHz
366MHz					ON			ON	ON		5.5X	66MHz
*550MHz		300MHz			ON					ON		100MHz

*Reserved

Section 3-2 System Memory Configuration

Memory Layout

The EP-MVP3M supports (2) 168-pin DIMMs (Dual In-line Memory Module). The DIMMs can be either EDO (Enhanced Data Out) or SDRAM (Synchronized DRAM).

- DIMM SDRAM may be 83MHz (12ns), 100MHz (10ns) or 125MHz (8ns) bus speed.
- If you use both 50ns and 60ns memory you must configure your BIOS to read 60ns.
- When using Synchronous DRAM we recommend using the 4 clock variety over the 2 clock.

Figure 2 and Table 1 show several possible memory configurations using both SIMM and DIMM.

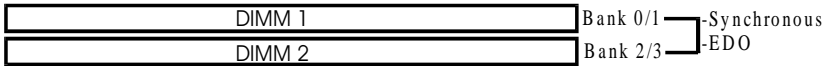

Figure 2

Total Memory	DIMM 1 (Bank 0/1)	DIMM 2 (Bank 2/3)
= 128MB Maximum	EDO/SDRAM* 8MB, 16MB, 32MB, 64MB, 128MB X 1	None
= 256MB Maximum	EDO/SDRAM* 8MB, 16MB, 32MB, 64MB, 128MB X 1	EDO/SDRAM* 8MB, 16MB, 32MB, 64MB, 128MB X 1

Table 1

* SDRAM only supports 8, 16, 32, 64, 128MB DIMM modules.

* We recommend to use PCI100 Memory Module for bus speed between 100MHz and 66MHz.

DIMM Module Installation

Figure 3 displays the notch marks and what they should look like on your DIMM memory module.

DIMMs have 168-pins and two notches that will match with the onboard DIMM socket. DIMM modules are installed by placing the chip firmly into the socket at a 90 degree angle and pressing straight down (figure 4) until it fits tightly into the DIMM socket (figure 5).

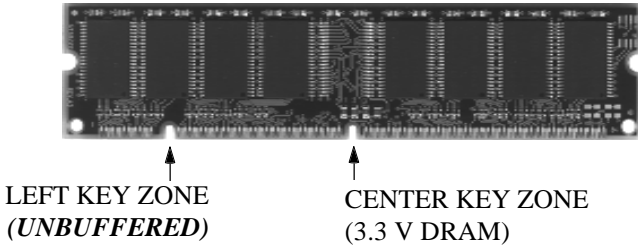

Figure 3

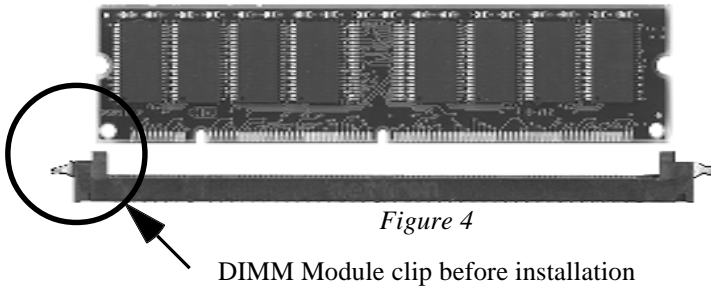

Figure 4

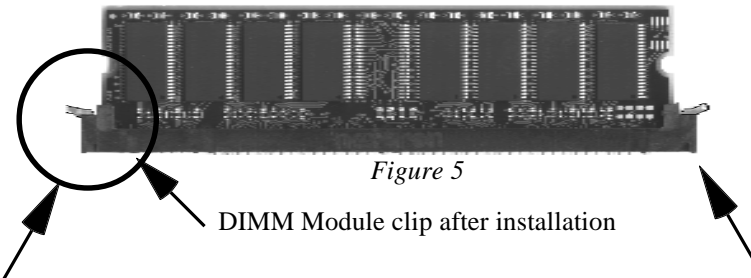

Figure 5

To remove the DIMM module simply press down both of the white clips on either side and the module will be released from the socket.

Section 3-4
Device Connectors

Please install the motherboard into the chassis.

Now that your motherboard is installed you are ready to connect all your connections (figure 6).

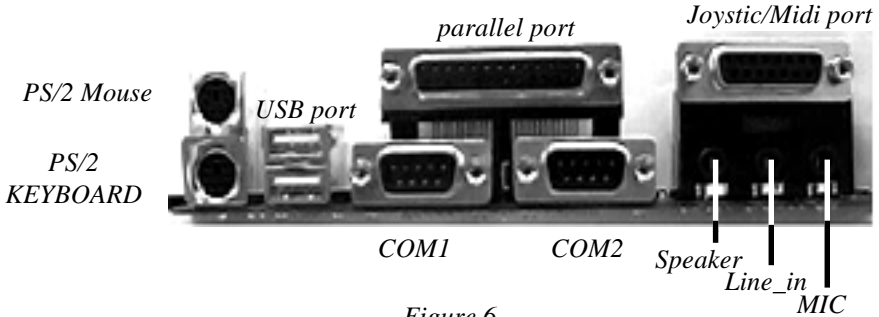
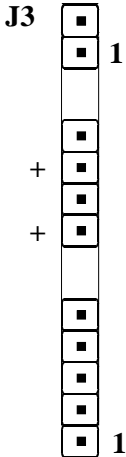

Figure 6

- J2:** Chassis Panel Connector
 - Power LED, Speaker, Reset
- J3:** Power_ON/OFF, Turbo LED, HDD LED, IR Connector
- J4:** CPU Fan Power
 - A plug-in for the CPU Fan Power
- J6:** Chassis Fan Power
 - A plug-in for the chassis Fan Power
- J7:** WOL (Wake On Lan) Connector
- IDE1:** Primary IDE
- IDE2:** Secondary IDE
- FDD1:** Floppy Controller Connector
- PW1:** ATX Power Connector
 - 20-pin power connector
- CD1:** CD Audio Connector
- AUX1:** AUX Audio Connector

Device Connectors (continued)

(This is connected to the power button on the case. Using the Soft-Off by Pwr-BTTN feature, you can choose either Instant Off (turns system off immediatly), or 4 sec delay (you need to hold the button down for 4 seconds before the system turns off). When the system is in 4 sec delay mode, there is a special feature to make the system to go into suspend mode when the button is pressed momentarily.)



Power On/Off

Turbo LED indicator - LED ON when higher speed is selected

IDE LED indicator - LED ON when Onboard PCI IDE Hard disks is activate

IR Connector

- 1. VCC
- 2. NC
- 3. IRRX
- 4. GND
- 5. IRTX

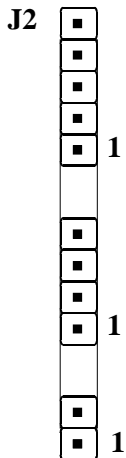

Power LED - Power LED connector

- 1. Power LED(+)
- 2. N/C
- 3. GND
- 4. NC
- 5. GND

Speaker - Connect to the system's speaker for beeping

- 1. Speaker
- 2. N/C
- 3. GND
- 4. GND

Reset - Closed to restart system.

Section 4 AWARD BIOS SETUP

BIOS Instructions

Award's ROM BIOS provides a built-in Setup program which allows user to modify the basic system configuration and hardware parameters. The modified data will be stored in a battery-backed CMOS, so that data will be retained even when the power is turned off. In general, the information saved in the CMOS RAM will stay unchanged unless there is a configuration change in the system, such as hard drive replacement or a device is added.

It is possible for the CMOS battery to fail, this will cause data loss in the CMOS only. If this does happen you will need to reconfigure your BIOS settings.

To enter the Setup Program :

Power on the computer and press the key immediately, this will bring you into the BIOS CMOS SETUP UTILITY.

ROM PCI / ISA BIOS (2A5LEPAF)
CMOS SETUP UTILITY
AWARD SOFTWARE, INC.

STANDARD CMOS SETUP BIOS FEATURES SETUP CHIPSET FEATURES SETUP POWER MANAGEMENT SETUP PNP/PCI CONFIGURATION INTEGRATED PERIPHERALS LOAD SETUP DEFAULTS	SENSOR AND CPU SPEED SETUP SUPERVISOR PASSWORD USER PASSWORD IDE HDD AUTO DETECTION SAVE & EXIT SETUP EXIT WITHOUT SAVING
ESC : Quit F10 : Save & Exit Setup	
↑ ↓ → ← : Select Item (Shift)F2 : Change Color	
Time, Date, Hard Disk Type...	

Figure 1: CMOS Setup Utility

The menu displays all the major selection items. Select the item you need to reconfigure. The selection is made by moving the cursor (press any direction key) to the item and pressing the 'Enter' key. An on-line help message is displayed at the bottom of the screen as the cursor is moved to various items which provides a better understanding of each function. When a selection is made, the menu of the selected item will appear so that the user can modify associated configuration parameters.

4-1 Standard CMOS Setup

Choose "Standard CMOS Setup" in the CMOS SETUP UTILITY Menu (Figure 2). The Standard CMOS Setup allows the user to configure system settings such as the current date and time, type of hard disk drive installed, floppy drive type, and display type. Memory size is auto-detected by the BIOS and displayed for your reference. When a field is highlighted (use direction keys to move the cursor and the <Enter> key to select), the entries in the field can be changed by pressing the <PgDn> or the <PgUp> key.

ROM PCI/ISA BIOS (2A5LEPAF)
STANDARD CMOS SETUP
AWARD SOFTWARE, INC.

Date (mm:dd:yy) : Wed, Apr 17 1996								
Time (hh:mm:ss) : 14 : 30 : 50								
HARD DISKS	TYPE	SIZE	CYLS	HEAD	PRECOMP	LANDZONE	SECTORS	MODE
Primary Master	: Auto	0	0	0	0	0	0	Auto
Primary Slave	: Auto	0	0	0	0	0	0	Auto
Secondary Master	: Auto	0	0	0	0	0	0	Auto
Secondary Slave	: Auto	0	0	0	0	0	0	Auto
Drive A : 1.44M, 3.5 in.								
Drive B : None								
Floppy 3 Mode Support : Disabled								
Video : EGA/VGA								
Halt On : All Errors								
				Base Memory : 640K				
				Extended Memory : 392192K				
				Other Memory : 384K				
				<hr/>				
				Total Memory : 393216K				
ESC : Quit		↑ ↓ → ← : Select Item			PU/PD/+/- : Modify			
F1 : Help		(Shift) F2 : Change Color						

Figure 2: Standard CMOS Setup

Note: If the hard disk Primary Master/Slave and Secondary Master/Slave are set to Auto, then the hard disk size and model will be auto-detected.

Note: The "Halt On:" field is used to determine when to halt the system by the BIOS if an error occurs.

Note: Floppy 3 Mode support is a mode used to support a special 3.5" drive used in Japan. This is a 3.5" disk that stores only 1.2 MB, the default setting for this is disabled.

4-2 BIOS Features Setup

Selecting the "BIOS FEATURES SETUP" option in the CMOS SETUP UTILITY menu allows users to change system related parameters in the displayed menu. This menu shows all of the manufacturer's default values for the EP-MVP3M.

Pressing the [F1] key will display a help message for the selected item.

ROM PCI/ISA BIOS (2A5LEPAF)
BIOS FEATURES SETUP
AWARD SOFTWARE, INC.

Virus Warning	: Disabled	Video BIOS	Shadow	: Enabled
CPU Internal Cache	: Enabled	C8000-CBFFF	Shadow	: Disabled
External Cache	: Enabled	CC000-CFFFF	Shadow	: Disabled
Quick Power On Self Test	: Enabled	D0000-D3FFF	Shadow	: Disabled
Boot Sequence	: A, C, SCSI	D4000-D7FFF	Shadow	: Disabled
Swap Floppy Drive	: Disable	D8000-DBFFF	Shadow	: Disabled
Boot Up Floppy Seek	: Enabled	DC000-DFFFF	Shadow	: Disabled
Boot Up NumLock Status	: On	Cyrix 6x86/MII CPUID		: Enabled
Gate A20 option	: Fast			
Memory Parity/ECC Check	: Disabled			
Typematic Rate Setting	: Disabled			
Typematic Rate (Chars/Sec)	: 6			
Typematic Delay (Msec)	: 250			
Security Option	: Setup			
PCI/VGA Palette Snoop	: Disabled			
OS Select For DRAM > 64MB	: Non-OS2	Esc : Quit		↑ ↓ → ← : Select Item
HDD S.M.A.R.T Capability	: Disabled	F1 : Help		PU/PD/+/- : Modify
Report No FDD For WIN 95	: Yes	F5 : Old Values		(Shift) F2 : Color
		F7 : Load Setup Defaults		

Figure 3: BIOS Features Setup

Virus Warning:

During and after the system boots up, any attempt to write to the boot sector or partition table of the hard disk drive will halt the system and an error message will appear.

You should then run an anti-virus program to locate the virus. Keep in mind that this feature protects only the boot sector, not the entire hard drive.

The default value is Disabled.

***Enabled:** Activates automatically when the system boots up causing a warning message to appear when anything attempts to access the boot sector.*

***Disabled:** No warning message will appear when anything attempts to access the boot sector.*

***Note:** Many disk diagnostic programs that access the boot sector table can trigger the virus warning message. If you plan to run such a program, we recommend that you first disable the virus warning.*

CPU Internal Cache:

This controls the status of the processor's internal cache area. The default is Enabled.

***Enabled:** This activates the processor's internal cache thereby increasing performance.*

***Disabled:** This deactivates the processor's internal cache thereby lowering performance.*

External (L2) Cache:

This controls the status of the external (L2) cache area.

The default is Enabled.

***Enabled:** This activates the motherboard's L2 cache thereby increasing performance.*

***Disabled:** This deactivates the motherboard's L2 cache thereby lowering performance.*

Quick Power On Self Test:

This category speeds up the Power On Self Test (POST).

The default is Enabled.

***Enabled:** This setting will shorten or skip of the items checked during POST.*

***Disabled:** Normal POST.*

Boot Sequence:

This category determines which drive is searched first by the O/S (Operating System). The default is A,C,SCSI.

The following is your list of options:

[A, C, SCSI] - [C, A, SCSI] - [C, CD-ROM, A] - [CD-ROM, C, A]

[D, A, CD-ROM],[E, A, CD-ROM] - [F, A, CD-ROM] - [SCSI, A, C]

[SCSI C, A] - [C Only]

Swap Floppy Drive:

This will swap your physical drive letters A & B if you are using two floppy disks. The default is Disabled.

Enabled: Floppy A & B will be swapped under the O/S.

Disabled: Floppy A & B will be not swapped.

Boot Up Floppy Seek:

During Power-On-Self-Test (POST), BIOS will determine if the floppy disk drive installed is 40 or 80 tracks. Only 360K type is 40 tracks while 760K, 1.2MB and 1.44MB are all 80 tracks.

The default is Enabled.

Enabled: The BIOS will search the floppy disk drive to determine if it is 40 or 80 tracks.

Disabled: The BIOS will not search for the type of floppy disk drive by track number.

NOTE: BIOS can not tell the difference between 720K, 1.2MB and 1.44MB drive types as they are all 80 tracks.

Boot Up NumLock Status:

This controls the state of the NumLock key when the system boots.

The default is On.

On: The keypad acts as a 10-key pad.

Off: The keypad acts like the cursor keys.

Gate A20 Option:

This refers to the way the system addresses memory above 1MB (extended memory). The default is Fast.

Normal: The A20 signal is controlled by the keyboard controller or chipset hardware.

Fast: The A20 signal is controlled by Port 92 or chipset specific method.

Typematic Rate Setting:

This determines the keystrokes repeat rate.

The default is Disabled.

Enabled: *Allows typematic rate and typematic delay programming.*

Disabled: *The typematic rate and typematic delay will be controlled by the keyboard controller in your system.*

Typematic Rate (Chars/Sec):

This is the number of characters that will be repeated by a keyboard press.

The default is 6.

6: *6 characters per second.*

8: *8 characters per second.*

10: *10 characters per second.*

12: *12 characters per second.*

15: *15 characters per second.*

20: *20 characters per second.*

24: *24 characters per second.*

30: *30 characters per second.*

Typematic Delay (msec):

This setting controls the time between the first and the second character displayed by typematic auto-repeat.

The default is 250.

250: *250 msec.*

500: *500 msec.*

750: *750 msec.*

1000: *1000 msec.*

Security Option:

This category allows you to limit access to the System and Setup, or just to Setup.

The default is Setup.

System: *The system will not boot and the access to Setup will be denied if the correct password is not entered at the prompt.*

Setup: *The system will boot; but the access to Setup will be denied if the incorrect password is not entered at the prompt.*

PCI/VGA Palette Snoop:

This field controls the ability of a primary PCI VGA controller to share a common palette (When a snoop write cycles) with an ISA video card.

The default is Disabled.

Enabled: *If an ISA card is connected to a PCI VGA card via the VESA connector, and that ISA card connects to a VGA monitor, then that ISA card uses the RAMDAC of the PCI card.*

Disabled: *Disables the VGA card Palette Snoop function.*

OS Select For DRAM > 64MB:

Some operating systems require special handling. Use this option only if your system has greater than 64MB of memory. The default is Non-OS2.

OS2: Select this if you are running the OS/2 operating system with greater than 64MB of RAM.

Non-OS2: Select this for all other operating systems and configurations.

HDD S.M.A.R.T Capability:

Enable SMART hard drive functions for compatible hardware. The default is Disabled.

Enabled: S.M.A.R.T features are available.

Disabled: S.M.A.R.T features will not be available.

Report No FDD For WIN 95:

This option allows the BIOS to indicate whether WIN95 will operate with a floppy disk drive or not. The default is Yes.

No: Report FDD to WIN95.

Yes: Report no FDD to WIN95.

Video BIOS Shadow:

This option allows video BIOS to be copied into RAM. Video Shadowing will increase the video performance of your system. The default is Enabled.

Enabled: Video shadow is enabled.

Disabled: Video shadow is disabled.

C8000 - CBFFF Shadow:**CC000 - CFFFF Shadow:****D0000 - D3FFF Shadow:****D4000 - D7FFF Shadow:****D8000 - DBFFF Shadow:****DC000 - DFFFF Shadow:**

These categories determine whether ROMs from option cards will be copied into RAM. This will be in 16K byte or 32K byte units, and the size will depend on chipset of the option card.

Enabled: Optional shadow is enabled.

Disabled: Optional shadow is disabled.

4-3 Chipset Features Setup

Choose the “CHIPSET FEATURES SETUP” in the CMOS SETUP UTILITY menu to display following menu.

ROM PCI/ISA BIOS (2A5LEPAF)
CHIPSET FEATURES SETUP
AWARD SOFTWARE, INC.

Bank 0/1 DRAM Timing	: Normal	OnChip USB	: Enabled
Bank 2/3 DRAM Timing	: Normal	USB Keyboard Support	: Disabled
Bank 4/5 DRAM Timing	: Normal	OnChip Sound	: Enabled
SDRAM Cycle length	: 3		
SDRAM Bank Interleave	: Disabled		
DRAM Page-Mode	: Enabled		
DRAM Read Pipeline	: Enabled		
DRAM Fast Decoding	: Auto		
Sustained 3T Write	: Enabled		
Cache Rd+CPU Wt Pipeline	: Enabled		
Cache Timing	: Fastest		
Video BIOS Cacheable	: Enabled		
System BIOS Cacheabe	: Enabled		
Memory Hole At 15Mb Addr.	: Disabled		
AGP Aperture Size	: 64M	Esc : Quit	↑ ↓ → ← : Select Item
AGP-2X Mode	: Enabled	F1 : Help	PU/PD/+/- : Modify
Cyrix M2 ADS# delay	: Enabled	F5 : Old Values	(Shift) F2 : Color
		F7 : Load Setup Defaults	

Figure 4: Chipset Features Setup

Bank 0/1, 2/3, 4/5 DRAM Timing:

This value in this field is set by the system board manufacturer, depending on whether the board has paged DRAMs or EDO (extended data output) DRAMs.

The Choice: Bank 0/1, 2/3, 4/5.

SDRAM Cycle length:

This setting defines the CAS timing parameter of the SDRAM in terms of clocks. The default is 3.

2: Provides faster memory performance.

3: Provides better memory compatibility.

SDRAM Bank Interleave:

The item allows you to set how many banks of SDRAM support in your mainboard.

The Choice: 2 Bank, 4 Bank, Disabled.

DRAM Page-Mode:

The item will active or inactive chipset page registers.

Enabled: Page-Mode Enabled.

Disabled: No page registers update and non Page-Mode operation.

DRAM Read Pipeline:

You may select *Enabled* for this field when PBRAMs are installed. Pipelining improves system performance.

The Choice: Enabled, Disabled.

DRAM Fast Decoding:

The item will effective DRAM operation sequential.

Sustained 3T Write:

This item allow you to enable or disable direct map write back / write through secondary cache.

The Choice: Enabled, Disabled.

Cache Rd+CPU Wt Pipeline:

This item allows you to enable/disable the cache timing.

The Choice: Enabled, Disabled.

Cache Timing:

The default value is Fastest.

Fast: Cache burst mode timing = 3 1 1 1 2 1 1 1.

Fastest: Cache burst mode timing = 3 1 1 1 1 1 1 1.

Video BIOS Cacheable:

When enabled. The Video BIOS cache will cause access to video BIOS addressed at C0000H to C7FFFH to be cached, if the cache controller is also enabled

The Choice: Enabled, Disabled.

System BIOS Cacheable:

As with caching the Video BIOS above, enabling this selection allows accesses to the system BIOS ROM addressed at F0000H-FFFFFH to be cached, provided that the cache controller is enabled.

The Choice: Enabled, Disabled.

Memory Hole At 15mb Addr.:

You can reserve this memory area for the use of ISA adaptor ROMs.

The default is Disabled.

Enabled: *This field enables the main memory (15~16MB) to remap to ISA BUS.*

Disabled: *Normal Setting.*

NOTE: *If this feature is enabled you will not be able to cache this memory segment.*

AGP Aperture Size:

The amount of system memory that the AGP card is allowed to share.

The default is 64.

4: *4MB of systems memory accessible by the AGP card.*

8: *8MB of systems memory accessible by the AGP card.*

16: *16MB of systems memory accessible by the AGP card.*

32: *32MB of systems memory accessible by the AGP card.*

64: *64MB of systems memory accessible by the AGP card.*

128: *128MB of systems memory accessible by the AGP card.*

256: *256MB of systems memory accessible by the AGP card.*

AGP - 2X Mode:

The item selects chipset AGP Mode capability.

1X: Chipset can work in 1X Mode.

2X: Chipset can work in 2X Mode.

OnChip USB:

Select Enabled if your system contains a Universal Serial Bus(USB) controller and you have a USB peripheral.

USB Keyboard Support:

This controls the activation status of an optional USB keyboard that may be attached.

The default is disabled.

Enabled: *Enable USB keyboard support.*

Disabled: *Disable USB keyboard support.*

OnChip Sound:

Turn on/off onchip sound device.

4-4 Power Management Setup

Choose the “POWER MANAGEMENT SETUP” in the CMOS SETUP UTILITY to display the following screen. This menu allows the user to modify the power management parameters and IRQ signals. In general, these parameters should not be changed unless it’s absolutely necessary.

ROM PCI/ISA BIOS (2A5LEPAF)
 POWER MANAGEMENT SETUP
 AWARD SOFTWARE, INC.

ACPI function	: Enabled	Primary INTR	: ON
Power Management	: User Define	IRQ3 (COM 2)	: Primary
PM Control by APM	: Yes	IRQ4 (COM 1)	: Primary
Video off Option	: Suspend -> off	IRQ5 (LPT 2)	: Primary
Video off Method	: V/H SYNC+Blank	IRQ6 (Floppy Disk)	: Primary
MODEM Use IRQ	: 3	IRQ7 (LPT 1)	: Primary
Soft-off by PWRBTN	: Delay 4 Sec	IRQ8 (RTC Alarm)	: Disabled
PWRON After PW-Fail	: Former-Sts	IRQ9 (IRQ2 Redir)	: Secondary
Fan In Suspend	: Off	IRQ10 (Reserved)	: Secondary
HDD Power Down	: Disabled	IRQ11 (Reserved)	: Secondary
Doze Mode	: Disabled	IRQ12 (PS/2 Mouse)	: Primary
Suspend Mode	: Disabled	IRQ13 (CoProcessor)	: Primary
VGA	: OFF	IRQ14 (HDD)	: Primary
LPT & COM	: LPT/COM	IRQ15 (Reserved)	: Disabled
HDD & FDD	: NO	Esc : Quit	↑ ↓ → ← : Select Item
PCI Master	: OFF	F1 : Help	PU/PD/+/- : Modify
Modem Ring Resume	: Disabled	F5 : Old Values	(Shift) F2 : Color
RTC Alarm Resume	: Disabled	F7 : Load Setup Defaults	

Figure 5: Power Management Setup

ACPI function:

Use this to enable or disable ACPI power management functions. The default is enabled.

Enabled: Enabled ACPI power management functions.

Disabled: Disabled ACPI power management functions.

You can only change the content of Doze Mode, Standby Mode, and Suspend Mode when the Power Management is set to ‘User Define’.

Power Management:

Use this to select your Power Management selection.

The default is User define.

Disabled: The system operates in NORMAL conditions (Non-GREEN), and the Power Management function is disabled.

Max. saving: *Maximum power savings. Inactivity period is 1 minute in each mode.*

Min. saving: *Minimum power savings. Inactivity period is 1 hour in each mode.*

User define: *Allows user to define PM Timers parameters to control power saving mode.*

PM control by APM:

This option shows whether or not you want the Power Management to be controlled by the Advanced Power Management (APM). The default is Yes.

Yes: *APM controls your PM*

No: *APM does not control your PM*

Video Off Option:

Tells you what time frame that the video will be disabled under current power management settings. The default is Suspend.

Standby: *Video powers off after time shown in standby mode setting.*

Doze: *Video powers off after time shown in doze mode setting.*

Suspend: *Video powers off after time shown in suspend mode setting.*

N/A: *Video power off not controlled by power management.*

Video Off Method:

This option allows you to select how the video will be disabled by the power management. The default is V/H Sync + Blank.

V/H Sync + Blank: *System turns off vertical and horizontal synchronization ports and writes blanks to the video buffer.*

DPMS: *Select this option if your monitor supports the Display Power Management Signaling (DPMS) standard of the Video Electronics Standards Association (VESA). Use the software supplied for your video subsystem to select video power management values.*

Blank Screen: *System only writes blanks to the video buffer.*

MODEM Use IRQ:

Name the interrupt request (IRQ) line assigned to the modem (if any) on your system. Activity of the selected IRQ always awakens the system. Default is IRQ 3.

N/A: *No IRQ is used. 3: IRQ 3*

4: *IRQ 4* **5:** *IRQ 5*

7: *IRQ 7* 9: *IRQ 9*
10: *IRQ 10* 11: *IRQ 11*

Soft-Off by PWR-BTTN:

Use this to select your soft-off function. The default is Delay 4 sec.

- Instant Off:** *Turns off instantly.*
Delay 4 Second : *Turns off after a 4 second delay. If momentary press of button, the system will go into Suspend Mode. Press again to take system out of Suspend Mode.*

PWRON After PW-Fail:

The system will stay of or power on after a power interrupte.

The default is Fomer-Status.

- Fomer-Status:** *Stay off or power on depend on system safe shut-down or power fail.*
ON: *System always power on after a power interrupte.*
OFF: *System always stay off after a power interrupte.*

FAN In Suspend:

This option is used to set if the CPU fans will turn off during suspend mode.

HDD Power Down:

HDD Standby timer can be set from 1 to 15 minute(s).

Doze Mode:

The “Doze” mode timer starts to count when no “PM events” have occurred.

Suspend Mode:

This function works only when the Pentium II Processor is installed. The timer starts to count when “System Standby” mode timer is timed out and no “PM Events” are occurring. Valid range is from 1 minute up to 1 hour.

VGA:

When set to *On* (default), any event occurring at a VGA port will awaken a system which has been powered down.

LPT & COM:

When set to *On* (default), any event occurring at a COM(serial)/LPT (printer) port will awaken a system which has been powered down.

HDD & FDD:

When set to *On* (default), any event occurring at a hard or floppy drive port will awaken a system which has been powered down.

PCI Master:

When set to *On* (default), any event occurring to the DMA controller will awaken a system which has been powered down.

Modem Ring Resume:

When set to *Enabled*, any event occurring to the Modem Ring will awaken a system which has been powered down.

RTC Alarm Resume:

When set to *Enable rta alarm resume*, you could set the date (of month) and timer (hh:mm:ss), any event occurring at will awaken a system which has been powered down.

Primary INTR:

When set to *On* (default), any event occurring at will awaken a system which has been powered down.

4-5 PNP/PCI Configuration

The PNP/PCI configuration program is for the user to modify the PCI/ISA IRQ signals when various PCI/ISA cards are inserted in the PCI or ISA slots.

WARNING: Conflicting IRQ's may cause the system to not find certain devices.

ROM PCI/ISA BIOS(2A5LEPAF)
 PNP/PCI CONFIGURATION
 AWARD SOFTWARE, INC.

PNP OS Installed	: No	CPU to PCI Write Buffer	: Enabled
Resources Controlled By	: Manual	PCI Dynamic Bursting	: Enabled
Reset Configuration Data	: Disabled	PCI Master 0 WS Write	: Enabled
IRQ - 3 assigned to	: PCI/ISA PnP	PCI Delay Transaction	: Enabled
IRQ - 4 assigned to	: PCI/ISA PnP	PCI#2 Access #1 Retry	: Disabled
IRQ - 5 assigned to	: PCI/ISA PnP	AGP Master 1 WS Write	: Enabled
IRQ - 7 assigned to	: PCI/ISA PnP	AGP Master 1 WS Read	: Disabled
IRQ - 9 assigned to	: PCI/ISA PnP	PCI Latency Timer (CLK)	: 32
IRQ -10 assigned to	: PCI/ISA PnP	Assign IRQ For USB	: Enabled
IRQ -11 assigned to	: PCI/ISA PnP	Assign IRQ For VGA	: Enabled
IRQ -12 assigned to	: PCI/ISA PnP	Slot 1 Use IRQ No.	: Auto
IRQ -14 assigned to	: PCI/ISA PnP	Slot 2 Use IRQ No.	: Auto
IRQ -15 assigned to	: PCI/ISA PnP	Slot 3 Use IRQ No.	: Auto
DMA -0 assigned to	: PCI/ISA PnP	Slot 4 Use IRQ No.	: Auto
DMA -1 assigned to	: PCI/ISA PnP		
DMA -3 assigned to	: PCI/ISA PnP	Esc : Quit	↑ ↓ → ← : Select Item
DMA -5 assigned to	: PCI/ISA PnP	F1 : Help	PU/PD/+/- : Modify
DMA -6 assigned to	: PCI/ISA PnP	F5 : Old Values	(Shift) F2 : Color
DMA -7 assigned to	: PCI/ISA PnP	F7 : Load Setup Defaults	

Figure 6: PCI Configuration Setup

PNP OS Installed:

Do you have a PNP OS installed on your system. The default is No.

Yes: Select if you are using a PNP OS

No: Select if your OS does not support PNP.

Resources Controlled By:

Who controlled the system PNP/PCI resources. The default is Manual.

Manual: PNP Card's resources will be controlled manually. You can set which IRQ-X and DMA-X are assigned to PCI/ISA PnP or Legacy ISA Cards.

Auto: If your ISA card and PCI card are all PNP cards, BIOS will assign the interrupt resource automatically.

Reset Configuration Data:

This setting allows you to clear ESCD data. The default is Disabled

Disabled: Normal Setting.

Enabled: If you have plugged in some Legacy cards to the system and they were recorded into ESCD (Extended System Configuration Data), you can set this field to Enabled in order to clear ESCD.

IRQ-3 to IRQ-15 assigned to:

These settings allow IRQ's to be reserved for Legacy ISA device use exclusively or be available for use with PNP devices. These options are only displayed if "Resources Controlled By" is set to manual.

DMA-0 to DMA-7 assigned to:

These settings allow DMA's to be reserved for Legacy ISA device use exclusively or be available for use with PNP devices. These options are only displayed if "Resources Controlled By" is set to manual.

CPU to PCI Write Buffer:

When enabled, up to four D words of data can be written to the PCI bus without interrupting the CPU. When disabled, a write buffer is not used and the CPU read cycle will not be completed until the PCI bus signals that it is ready to receive the data.

The Choice: Enabled, Disabled.

PCI Dynamic Bursting:

When Enabled, data transfers on the PCI bus, where possible, make use of the high-performance PCI burst protocol, in which greater amounts of data are transferred at a single command.

The Choice: Enabled, Disabled.

PCI Master 0 WS Write:

When Enabled, writes to the PCI bus are command with zero wait states.

The Choice: Enabled, Disabled.

PCI Delay Transaction:

The chipset has an embedded 32-bit posted write buffer to support delay transactions cycles. Select Enabled to support compliance with PCI specification version 2.1.

The Choice: Enabled, Disabled.

PCI #2 Access #1 Retry:

This item allows you enabled/disable the PCI #2 Access #1 Retry.

The Choice: Enabled, Disabled.

Assign IRQ For USB:

This item allows BIOS to assign whether IRQ is with USB or not. If you have not connect the USB device. Can release IRQ for other device. The default is Enabled.

Disabled: Provides IRQ for USB device

Enabled: Release IRQ for other device

Assign IRQ For VGA:

This item allows BIOS to assign IRQ for VGA device. The default is Enabled.

Disabled: The system was not assigned IRQ for VGA Card

Enabled: The system was assigned IRQ for VGA Card

Slot 1 to Slot 4 Use IRQ No.:

This settings allows the user to specify what IRQ will be assigned to PCI devices in the chosen slot. Options available: Auto, 3, 4, 5, 7, 9, 10,11,12,14 & 15. The default are auto.

4-6 Load Setup Defaults

The “LOAD SETUP DEFAULTS” function loads the system default data directly from ROM and initializes the associated hardware properly. This function will be necessary only when the system CMOS data is corrupted.

4-7 Integrated Peripherals

ROM PCI/ISA BIOS(2A5LEPAF)
 INTEGRATED PERIPHERALS
 AWARD SOFTWARE, INC.

OnChip IDE First Channel	: Enabled	Onboard Parallel Mode	: ECP/EPP
OnChip IDE Second Channel	: Enabled	Onboard Parallel Port	: 378/IRQ7
IDE Prefetch Mode	: Enabled	ECP Mode Use DMA	: 3
IDE HDD Block Mode	: Enabled	Parallel Port EPP Type	: EPP1.9
IDE Primary Master PIO	: Auto	Onboard Legacy Audio	: Enabled
IDE Primary Slave PIO	: Auto	Sound Blaster	: Disabled
IDE Secondary Master PIO	: Auto	SB I/O Base Address	: 220H
IDE Secondary Slave PIO	: Auto	SB IRQ Select	: IRQ 5
IDE Primary Master UDMA	: Auto	SB DMA Select	: DMA 1
IDE Primary Slave UDMA	: Auto	MPU-401	: Disabled
IDE Secondary MasterUDMA	: Auto	MPU-401 I/O Address	: 330-333H
IDE Secondary Slot 4 Use IRQ No.	: Auto	FM Port (388-38BH)	: Disabled
IDE Slave UDMA	: Auto	Game Port (200-207H)	: Enabled
Init Display First	: PCI Slot		
Onboard FDD Controller	: Enabled	Esc : Quit	↑ ↓ → ← : Select Item
Onboard Serial Port 1	: Auto	F1 : Help	PU/PD/+/- : Modify
Onboard Serial Port 2	: Auto	F5 : Old Values	(Shift) F2 : Color
UART 2 Mode	: Standard	F7 : Load Setup Defaults	

Figure 7: Integrated Peripherals

Note: If you do not use the Onboard IDE connector, then you will need to set Onboard Primary PCI IDE: Disabled and Onboard Secondary PCI IDE: Disabled

Note: The Onboard PCI IDE cable should be equal to or less than 18 inches (45 cm.).

Onchip IDE First Channel:

The default value is Enabled.

Enabled: Enables Onboard IDE primary port.

Disabled: Disables Onboard IDE primary port.

Onchip IDE Second Channel:

The default is Enabled.

Enabled: Enables Onboard IDE secondary port.

Disabled: Disables Onboard IDE secondary port.

IDE Prefetch Mode:

Enable prefetching for IDE drive interfaces that support its faster drive accesses. If you are getting disk drive errors, change the setting to omit the drive interface where the errors occur. Depending on the configuration of your IDE subsystem, this field may not appear, and it does not appear when the Internal PCI/IDE field, above, is Disabled.

The Choice: Enabled, Disabled.

IDE HDD Block Mode:

IDE Block Mode allows the controller to access blocks of sectors rather than a single sector at a time. The default is Enabled.

Enabled: Enabled IDE HDD Block Mode. Provides higher HDD transfer rates.

Disabled: Disable IDE HDD Block Mode.

IDE Primary Master PIO:

The default is Auto.

Auto: BIOS will automatically detect the Onboard Primary Master PCI IDE HDD Accessing mode.

Mode 0~4: Manually set the IDE Programmed interrupt mode.

IDE Primary Slave PIO:

The default is Auto.

Auto: BIOS will automatically detect the Onboard Primary Slave PCI IDE HDD Accessing mode.

Mode 0~4: Manually set the IDE Programmed interrupt mode.

IDE Secondary Master PIO:

The default is Auto.

Auto: BIOS will automatically detect the Onboard Secondary Master PCI IDE HDD Accessing mode.

Mode 0~4: Manually set the IDE Programmed interrupt mode.

IDE Secondary Slave PIO:

The default is Auto.

Auto: BIOS will automatically detect the Onboard Secondary Slave PCI IDE HDD Accessing mode.

Mode 0~4: Manually set the IDE Programmed interrupt mode.

IDE Primary Master UDMA:

This allows you to select the mode of operation for the hard drive.

The default is Auto.

Auto: The computer will select the optimal setting.

Disabled: The hard drive will run in normal mode.

IDE Primary Slave UDMA:

This allows you to select the mode of operation for the hard drive.

The default is Auto.

Auto: The computer will select the optimal setting.

Disabled: The hard drive will run in normal mode.

IDE Secondary Master UDMA:

This allows you to select the mode of operation for the hard drive.

The default is Auto.

Auto: The computer will select the optimal setting.

Disabled: The hard drive will run in normal mode.

IDE Secondary Slave UDMA:

This allows you to select the mode of operation for the hard drive.

The default is Auto.

Auto: The computer will select the optimal setting.

Disabled: The hard drive will run in normal mode.

Init Display First:

If two video cards are used (1 AGP and 1 PCI) this specifies which one will be the primary display adapter. The default is PCI Slot.

PCI Slots: PCI video card will be primary adapter.

AGP: AGP video card will be primary adapter.

Onboard FDD Controller:

This controls the state of the onboard floppy controller. The default value is Enabled.

Enabled: Enable the Onboard floppy drive interface controller.

Disabled: Disable the Onboard floppy drive interface controller.

Onboard Serial Port 1:

This field allows the user to configure the 1st serial port. The default is Auto.

AUTO: Enable Onboard Serial port 1 and address is Auto adjusted

COM1: Enable Onboard Serial port 1 and address is 3F8H/IRQ4.

COM2: Enable Onboard Serial port 1 and address is 2F8H/IRQ3.

COM3: Enable Onboard Serial port 1 and address is 3E8H/IRQ4.

COM4: Enable Onboard Serial port 1 and address is 2E8H/IRQ3.

Disabled: Disable Onboard Serial port 1.

Onboard Serial Port 2:

This field allows the user to configure the 2nd serial port. The default is Auto.

AUTO: Enable Onboard Serial port 2 and address is Auto adjusted

COM1: Enable Onboard Serial port 2 and address is 3F8H/IRQ4.

COM2: Enable Onboard Serial port 2 and address is 2F8H/IRQ3.

COM3: Enable Onboard Serial port 2 and address is 3E8H/IRQ4.

COM4: Enable Onboard Serial port 2 and address is 2E8H/IRQ3.

Disabled: Disable Onboard Serial port 2.

UART 2 Mode:

This item allows you to determine which Infra Red (IR) function of onboard I/O chip.

The Choice: Standard, ASKIR, HPSIR.

Onboard Parallel Mode:

This field allows the user to select the parallel port mode. The default is ECP+EPP.

Normal: Standard mode. IBM PC/AT Compatible bidirectional parallel port.

EPP: Enhanced Parallel Port mode.

ECP: Extended Capabilities Port mode.

EPP+ECP: ECP Mode & EPP Mode.

Onboard Parallel port:

This field allows the user to configure the LPT port. The default is 378H / IRQ7.

378H: Enable Onboard LPT port and address is 378H and IRQ7.

278H: Enable Onboard LPT port and address is 278H and IRQ5.

3BCH: Enable Onboard LPT port and address is 3BCH and IRQ7.

Disabled: Disable Onboard LPT port.

ECP Mode USE DMA:

This field allows the user to select DMA1 or DMA3 for the ECP mode.
The default is DMA3.

DMA1: This field selects the routing of DMA1 for the ECP mode.

DMA3: This field selects the routing of DMA3 for the ECP mode.

Parallel Port EPP Type:

This item allows you to determine the IR transfer mode of onboard I/O chip.

The Choice: EPP1.9, EPP1.7.

Onboard Legacy Audio:

Legacy Audio enabled/disabled.

Sound Blaster:

Sound Blaster compatible device enabled/disabled.

SB I/O Base Address:

Sound Blaster I/O resource selection.

SB IRQ Select:

Legacy audio device IRQ selection.

SB DMA Select:

Sound Blaster DMA channel selection.

MPU-401:

MPU-401 function enabled/disabled.

MPU-401 I/O Address:

Built-in MPU-401 compatible MIDI I/O port selection:

300-303H

310-313H

320-323H

330-333H (default)

FM Port (388-38BH):

Frequency modulation port at I/O port 388-38BH enabled/disabled.

Game Port (200-207H):

Built-in joystick port support disabled/enabled(default).

4-8 SENSOR AND CPU SPEED SETUP

ROM PCI/ISA BIOS(2A5LEPAF)
SENSOR AND CPU SPEED SETUP
AWARD SOFTWARE, INC.

Auto Detect DIMM/PCI Clk	: Enabled	Current CPU Temp.	: 35°C/95°F
Spread Spectrum	: Disabled	Current System Temp.	: 26°C/78°F
CPU Host Clock (CPU/PCI)	: Default	Current CPU Fan Speed	: 5080 RPM
		Current Chassis Fan Speed	: 0 RPM
		Vcore	: 2.40V
		Vtt	: 2.40V
		Vio	: 3.33V
		5V	: 5.15V
		12V	: 12.12V
		Esc	: Quit
		F1	: Help
		F5	: Old Values
		F7	: Load Setup Defaults
		↑ ↓ → ←	: Select Item
		PU/PD/+/-	: Modify
		(Shift) F2	: Color

Figure 8: Sensor And CPU Speed Setup

Auto Detect DIMM/PCI Clk:

When enabled the motherboard will automatically disable the clock source for a DIMM socket which does not have a module in it. Same applies for PCI slots. The default is Enabled.

- Enabled:* Enables this option.
- Disabled:* Disables this option.

Spread Spectrum :

The default is Disabled.

- Enabled:* Enables this option.
- Disabled:* Disables this option.

CPU Host Clock (CPU/PCI):

Allows the external clock to be modified depending upon what FSB has been selected. Should not be used to clock processor faster than it was designed for. The default is Default.

- 66MHz FSB options:* Default, 66.8, 68.5, 75, and 83MHz.
- 100MHz FSB options:* Default, 100, 103, 112, and 133MHz.

Current CPU Temperature:

This is the current temperature of the CPU.

Current System Temp:

This is the Current temperature of the system.

Current CPU FAN Speed:

The current CPU fan speed in RPMs.

Current Chassis FAN Speed:

The current chassis fan speed in RPMs.

CPU(V): The voltage level of the CPU($V_{io}/V_{core}/V_{tt}$).

+5V, +12V: The voltage level of the switch power supply.

4-9 Change Supervisor or User Password

To change the password, choose the “SUPERVISOR PASSWORD or USER PASSWORD” option from the CMOS SETUP UTILITY menu and press [Enter].

NOTE: Either “Setup” or “System” must be selected in the “Security Option” of the BIOS FEATURES SETUP menu.

1. If CMOS is corrupted or the option was not used, a default password stored in the ROM will be used. The screen will display the following message:

Enter Password:

Press the [Enter] key to continue after the proper password is given.

2. If the CMOS is corrupted or the option was used earlier and the user wishes to change the default password, the SETUP UTILITY will display a message and ask for a confirmation.

Confirm Password:

3. After pressing the [Enter] key (ROM password if the option was not used) or current password (user-defined password), the user can change the password and store new one in CMOS RAM. A maximum of 8 characters can be entered.

4-10 IDE HDD Auto Detection

The “IDE HDD auto detection” utility is a very useful tool, especially when you do not know which kind of hard disk type you are using. You can use this utility to detect the correct disk type installed in the system automatically. But now you can set HARD DISK TYPE to Auto in the STANDARD CMOS SETUP. You don’t need the “IDE HDD AUTO DETECTION” utility. The BIOS will Auto-detect the hard disk size and model on display during POST.

ROMPCI/ISA BIOS (2A5LEPAF)
CMOSSETUPUTILITY
AWARD SOFTWARE, INC.

HARD DISKS	TYPE	SIZE	CYLS	HEADS	PRECOMP	LANDZONE	SECTORS	MODE
Primary Master :								
Select Secondary Slave Option (N=Skip) : N								
OPTIONSSIZE	CYLS	HEAD	PRECOMP	LANDZ	SECTORMODE			
2 (Y)	4310	524	255	0	14847	63	LBA	
1	4310	14848	9	65535	14847	63	NORMAL	
3	4310	928	144	65535	14847	63	LARGE	
Note: Some OSes (like SCO-UNIX) must use NORMAL for installation								
ESC : Skip								

Figure 9: IDE HDD Auto Detection

NOTE: HDD Modes

The Award BIOS supports 3 HDD modes : NORMAL, LBA & LARGE NORMAL mode

Generic access mode in which neither the BIOS nor the IDE controller will make any transformations during accessing.

The maximum number of cylinders, head & sectors for NORMAL mode are 1024, 16 & 63.

- no. Cylinder (1024)
 - x no. Head (16)
 - x no. Sector (63)
 - x no. per sector (512)
- 528 Megabytes

If user set his HDD to NORMAL mode, the maximum accessible HDD size will be 528 Megabytes even though its physical size may be greater than that!

LBA (Logical Block Addressing) mode: A new HDD accessing method to overcome the 528 Megabyte bottleneck. The number of cylinders, heads & sectors shown in setup may not be the number physically contained in the HDD. During HDD accessing, the IDE controller will transform the logical address described by sector, head & cylinder into its own physical address inside the HDD. The maximum HDD size supported by LBA mode is 8.4 GigaBytes which is obtained by the following formula:

$$\begin{aligned}
 &\text{no. Cylinder} && (1024) \\
 &x \text{ no. Head} && (255) \\
 &x \text{ no. Sector} && (63) \\
 &\underline{x \text{ bytes per sector}} && (\underline{512}) \\
 &&& 8.4 \text{ GigaBytes}
 \end{aligned}$$

LARGE mode: Extended HDD access mode supported by Award Software.

Some IDE HDDs contain more than 1024 cylinder without LBA support (in some cases, user do not want LBA). The Award BIOS provides another alternative to support these kinds of LARGE mode.

<u>CYLS</u>	<u>HEADS</u>	<u>SECTOR</u>	<u>MODE</u>
1120	16	59	NORMAL
560	32	59	LARGE

BIOS tricks DOS (or other OS) that the number of cylinders is less than 1024 by dividing it by 2. At the same time, the number of heads is multiplied by 2. A reverse transformation process will be made inside

INT 12h in order to access the right HDD address!

Maximum HDD size:

$$\begin{aligned}
 &\text{no. Cylinder} && (1024) \\
 &x \text{ no. Head} && (32) \\
 &x \text{ no. Sector} && (63) \\
 &\underline{x \text{ bytes per sector}} && (\underline{512}) \\
 &&& 1 \text{ GigaByte}
 \end{aligned}$$

Note: To support LBA or LARGE mode of HDDs, there must be some software involved. All the software is located in the Award HDD Service Routine (INT 13h). It may fail to access a HDD with LBA (LARGE) mode selected if you are running under an Operating System which replaces the whole INT 13h.

UNIX operating systems do not support either LBA or LARGE and must utilize the Standard mode. UNIX can support drives larger than 528MB.

4-11 Save & Exit Setup

The “SAVE & EXIT SETUP” option will bring you back to the boot up procedure with all the changes you just recorded in the CMOS RAM.

4-12 Exit Without Saving

The “EXIT WITHOUT SAVING” option will bring you back to normal boot up procedure without saving any data into CMOS RAM.

All old data in the CMOS will not be destroyed.

Appendix A

A-1 MEMORY MAP

Address Range	Size	Description
[00000-7FFFF]	512K	Conventional memory
[80000-9FBFF]	127K	Extended Conventional memory
[9FC00-9FFFF]	1K	Extended BIOS data area if PS/2 mouse is installed
[A0000-C7FFF]	160K	Available for Hi DOS memory
[C8000-DFFFF]	96K	Available for Hi DOS memory and adapter ROMs
[E0000-EEFFF]	60K	Available for UMB
[EF000-EFFFF]	4K	Video service routine for Monochrome & CGA adaptor
[F0000-F7FFF]	32K	BIOS CMOS setup utility
[F8000-FCFFF]	20K	BIOS runtime service routine (2)
[FD000-FDFFF]	4K	Plug and Play ESCD data area
[FE000-FFFFF]	8K	BIOS runtime service routine (1)

A-2 I/O MAP

[000-01F]	DMA controller.(Master)
[020-021]	INTERRUPT CONTROLLER.(Master)
[022-023]	CHIPSET control registers. I/O ports.
[040-05F]	TIMER control registers.
[060-06F]	KEYBOARD interface controller.(8042)
[070-07F]	RTC ports & CMOS I/O ports.
[080-09F]	DMA register.
[0A0-0BF]	INTERRUPT controller.(Slave)
[0C0-0DF]	DMA controller.(Slave)
[0F0-0FF]	MATH COPROCESSOR.
[1F0-1F8]	HARD DISK controller.
[278-27F]	PARALLEL port 2.
[2B0-2DF]	GRAPHICS adapter controller.

[2F8-2FF]	SERIAL port 2.
[360-36F]	NETWORK ports.
[378-37F]	PARALLEL port 1.
[3B0-3BF]	MONOCHROME & PARALLEL port adapter.
[3C0-3CF]	EGA adapter.
[3D0-3DF]	CGA adapter.
[3F0-3F7]	FLOPPY DISK controller.
[3F8-3FF]	SERIAL port 1.

A-3 TIMER & DMA CHANNELS MAP

TIMER MAP:

TIMER Channel 0	System timer interrupt.
TIMER Channel 1	DRAM REFRESH request.
TIMER Channel 2	SPEAKER tone generator.

DMA CHANNELS:

DMA Channel 0	Available.
DMA Channel 1	Onboard ECP (Option).
DMA Channel 2	FLOPPY DISK (SMC CHIP).
DMA Channel 3	Onboard ECP (default).
DMA Channel 4	Cascade for DMA controller 1.
DMA Channel 5	Available.
DMA Channel 6	Available.
DMA Channel 7	Available.

A-4 INTERRUPT MAP

NMI :

Parity check error.

IRQ (H/W):

0	System TIMER interrupt from TIMER 0.
1	KEYBOARD output buffer full.
2	Cascade for IRQ 8-15.
3	SERIAL port 2.
4	SERIAL port 1.
5	PARALLEL port 2.

6	FLOPPY DISK (SMC CHIP).
7	PARALLEL port 1.
8	RTC clock.
9	Available.
10	Available.
11	Available.
12	PS/2 Mouse.
13	MATH coprocessor.
14	Onboard HARD DISK (IDE1) channel.
15	Onboard HARD DISK (IDE1) channel.

A-5 RTC & CMOS RAM MAP

RTC & CMOS:

00	Seconds.
01	Second alarm.
02	Minutes.
03	Minutes alarm.
04	Hours.
05	Hours alarm.
06	Day of week.
07	Day of month.
08	Month.
09	Year.
0A	Status register A.
0B	Status register B.
0C	Status register C.
0D	Status register D.
0E	Diagnostic status byte.
0F	Shutdown byte.
10	FLOPPY DISK drive type byte.
11	Reserve.
12	HARD DISK type byte.
13	Reserve.
14	Equipment type.
15	Base memory low byte.

16	Base memory high byte.
17	Extension memory low byte.
18	Extension memory high byte.
19-2d	
2E-2F	
30	Reserved for extension memory low byte.
31	Reserved for extension memory high byte.
32	DATE CENTURY byte.
33	INFORMATION FLAG.
34-3F	Reserve.
40-7F	Reserved for CHIPSET SETTING DATA.

Appendix B

B-1 POST CODES

ISA POST codes are typically output to I/O port address 80h.

POST (hex)	DESCRIPTION
01-02	Reserved.
C0	Turn off OEM specific cache, shadow.
03	<ol style="list-style-type: none"> 1. Initialize EISA registers (EISA BIOS only). 2. Initialize all the standard devices with default values Standard devices includes. <ul style="list-style-type: none"> - DMA controller (8237). - Programmable Interrupt Controller (8259). - Programmable Interval Timer (8254). - RTC chip.
04	Reserved
05	1. Keyboard Controller Self-Test.
06	2. Enable Keyboard Interface.
07	Reserved.
08	Verifies CMOS's basic R/W functionality.
C1	Auto-detection of onboard DRAM & Cache.
C5	Copy the BIOS from ROM into E0000-FFFFFF shadow RAM so that POST will go faster.
08	Test the first 256K DRAM.
09	OEM specific cache initialization. (if needed)
0A	<ol style="list-style-type: none"> 1. Initialize the first 32 interrupt vectors with corresponding Interrupt handlers. Initialize INT numbers from 33-120 with Dummy (Spurious) Interrupt Handler. 2. Issue CPUID instruction to identify CPU type. 3. Early Power Management initialization. (OEM specific)
0B	<ol style="list-style-type: none"> 1. Verify the RTC time is valid or not. 2. Detect bad battery. 3. Read CMOS data into BIOS stack area. 4. PnP initializations including. (PnP BIOS only) <ul style="list-style-type: none"> - Assign CSN to PnP ISA card.

	- Create resource map from ESCD.
	5. Assign IO & Memory for PCI devices. (PCI BIOS only)
0C	Initialization of the BIOS Data Area. (40:0N - 40:FF)
0D	1. Program some of the Chipset's value according to Setup. (Early Setup Value Program)
	2. Measure CPU speed for display & decide the system clock speed.
	3. Video initialization including Monochrome, CGA, EGA/VGA. If no display device found, the speaker will beep.
0E	1. Test video RAM. (If Monochrome display device found)
	2. Show messages including.
	- Award Logo, Copyright string, BIOS Data code & Part No.
	- OEM specific sign on messages.
	- Energy Star Logo. (Green BIOS ONLY)
	- CPU brand, type & speed.
	- Test system BIOS checksum. (Non-Compress Version only)
0F	DMA channel 0 test.
10	DMA channel 1 test.
11	DMA page registers test.
12-13	Reserved.
14	Test 8254 Timer 0 Counter 2.
15	Test 8259 interrupt mask bits for channel 1.
16	Test 8259 interrupt mask bits for channel 2.
17	Reserved.
19	Test 8259 functionality.
1A-1D	Reserved.
1E	If EISA NVM checksum is good, execute EISA initialization. (EISA BIOS only)
1F-29	Reserved.
30	Detect Base Memory & Extended Memory Size.
31	1. Test Base Memory from 256K to 640K.
	2. Test Extended Memory from 1M to the top of memory.
32	1. Display the Award Plug & Play BIOS Extension message. (PnP BIOS only)

-
- | | |
|-------|---|
| | 2. Program all onboard super I/O chips (if any) including COM ports, LPT ports, FDD port ... according to setup value. |
| 33-3B | Reserved. |
| 3C | Set flag to allow users to enter CMOS Setup Utility. |
| 3D | 1. Initialize Keyboard.
2. Install PS2 mouse. |
| 3E | Try to turn on Level 2 cache.
Note: Some chipset may need to turn on the L2 cache in this stage.
But usually, the cache is turn on later in POST 61h. |
| 3F-40 | Reserved. |
| BF | 1. Program the rest of the Chipset's value according to Setup. (Later Setup Value Program) |
| 41 | 2. If auto-configuration is enabled, program the chipset with pre-defined Values. |
| 42 | Initialize floppy disk drive controller. |
| 43 | Initialize Hard drive controller. |
| 45 | If it is a PnP BIOS, initialize serial & parallel ports. |
| 44 | Reserved. |
| 45 | Initialize math coprocessor. |
| 46-4D | Reserved. |
| 4E | If there is any error detected (such as video, kb...), show all error messages on the screen & wait for user to press <F1> key. |
| 4F | 1. If password is needed, ask for password.
2. Clear the Energy Star Logo. (Green BIOS only) |
| 50 | Write all CMOS values currently in the BIOS stack area back into the CMOS. |
| 51 | Reserved. |
| 52 | 1. Initialize all ISA ROMs.
2. Later PCI initializations. (PCI BIOS only) <ul style="list-style-type: none">- assign IRQ to PCI devices.- initialize all PCI ROMs. 3. PnP Initialzations. (PnP BIOS only) <ul style="list-style-type: none">- assign IO, Memory, IRQ & DMA to PnP ISA devices.- initialize all PnP ISA ROMs. 4. Program shadows RAM according to Setup settings. |
-

- 5. Program parity according to Setup setting.
- 6. Power Management Initialization.
 - Enable/Disable global PM.
 - APM interface initialization.
- 53 1. If it is NOT a PnP BIOS, initialize serial & parallel ports.
- 2. Initialize time value in BIOS data area by translate the RTC time value into a timer tick value.
- 60 Setup Virus Protection. (Boot Sector Protection) function ality according to Setup setting.
- 61 1. Try to turn on Level 2 cache.
 Note: If L2 cache is already turned on in POST 3D, this part will be skipped.
- 2. Set the boot up speed according to Setup setting.
- 3. Last chance for Chipset initialization.
- 4. Last chance for Power Management initialization. (Green BIOS only)
- 5. Show the system configuration table.
- 62 1. Setup daylight saving according to Setup value.
- 2. Program the NUM Lock, typematic rate & typematic speed according to Setup setting.
- 63 1. If there is any changes in the hardware configuration, update the ESCD information. (PnP BIOS only)
- 2. Clear memory that have been used.
- 3. Boot system via INT 19H.
- FF System Booting. This means that the BIOS already pass the control right to the operating system.

B-2 Unexpected Errors:

POST (hex)	DESCRIPTION
B0	If interrupt occurs in protected mode.
B1	Unclaimed NMI occurs.0

Appendix C

NOTE:

The "LOAD SETUP DEFAULTS" function loads the system default data directly from ROM and initializes the associated hardware properly. This function will be necessary when you accept this mainboard, or the system CMOS data is corrupted.

ROMPCI/ISA BIOS(2A5LHPA9)
CMOS SETUP UTILITY
AWARD SOFTWARE, INC.

STANDARD CMOS SETUP	SENSOR AND CPU SPEED SETUP
BIOS FEATURES SETUP	SUPERVISOR PASSWORD
CHIPSET FEATURES SETUP	USER PASSWORD
POWER MANAGEMENT SETUP	IDE HDD AUTO DETECTION
PNP/PCI CONFIGURATION	LOAD SETUP DEFAULTS
INTEGRATED PERIPHERALS	SETUP SAVING
Load SETUP Default (Y/N)? Y	
ESC: QUIT	
F10: Save & Exit Setup	
↑ ↓ → ← : SELECT ITEM (Shift)F2 : Change Color	
Load Setup Defaults Except Standard COMS SETUP	

LOAD SETUP DEFAULTS

Page Left Blank

Appendix D

D-1 GHOST 5.1 Quick User's Guide

Installation is very easy. You only need to copy the **Ghost5** folder or **Ghost.exe** to your hard disk.

The current market version is for single **Client**, so the LPT and NetBios portions will not be explained further.

Description of Menus

Ghost clones and backs up **Disk** and **Partition**.

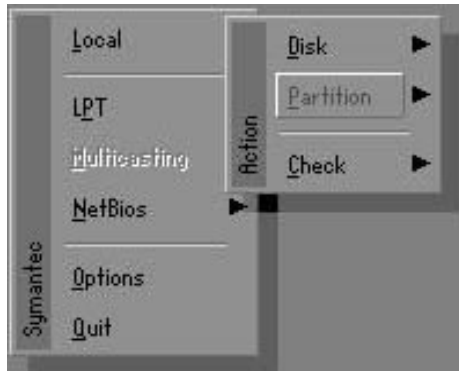

In which **Disk** indicates hard disk options
Partition indicates partition options
Check indicates check options

Disk

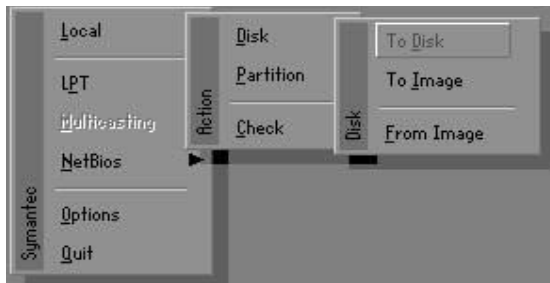

There are 3 hard disk functions:

1. Disk To Disk (disk cloning)
2. Disk To Image (disk backup)
3. Disk From Image (restore backup)

Important!

1. To use this function, the system must have at least 2 disks. Press the **Tab** key to move the cursor.
2. When restoring to a destination disk, all data in that disk will be completely destroyed.

Disk To Disk (Disk Cloning)

1. Select the location of the **Source drive**.
2. Select the location of the **Destination drive**.

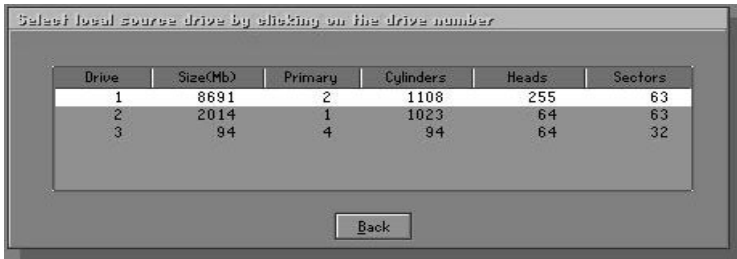

3. When cloning a disk or restoring the backup, set the required partition size as shown in the following figure.

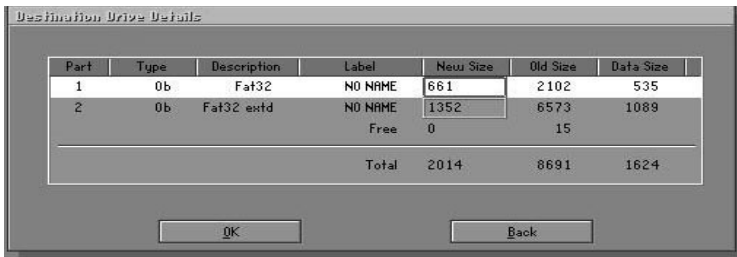

- Click OK to display the following confirmation screen. Select **Yes** to start.

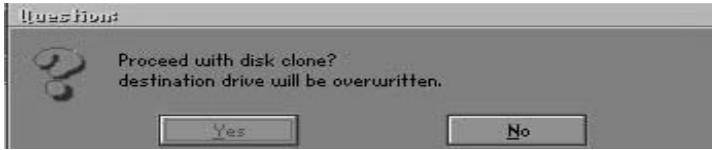

Disk To Image (Disk Backup)

- Select the location of the Source drive.

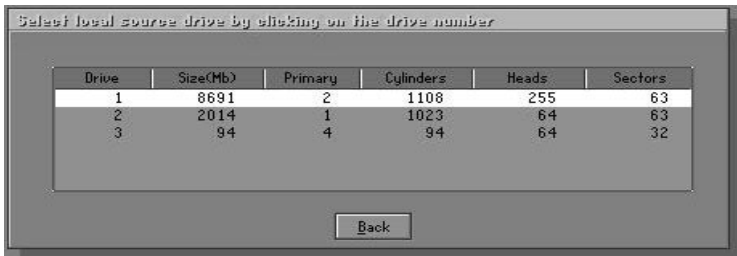

- Select the location for storing the backup file.

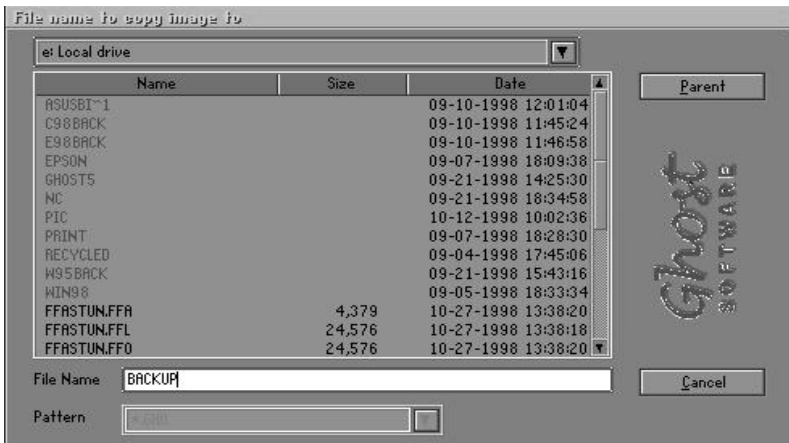

- Click **OK** to display the following confirmation screen. Select **Yes** to start.

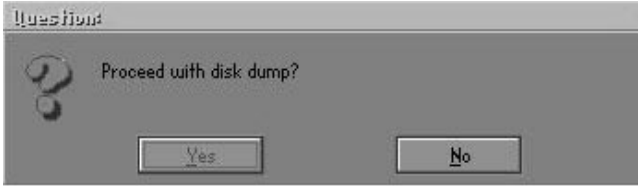

Disk From Image (Restore Backup)

- Select the Restore file.

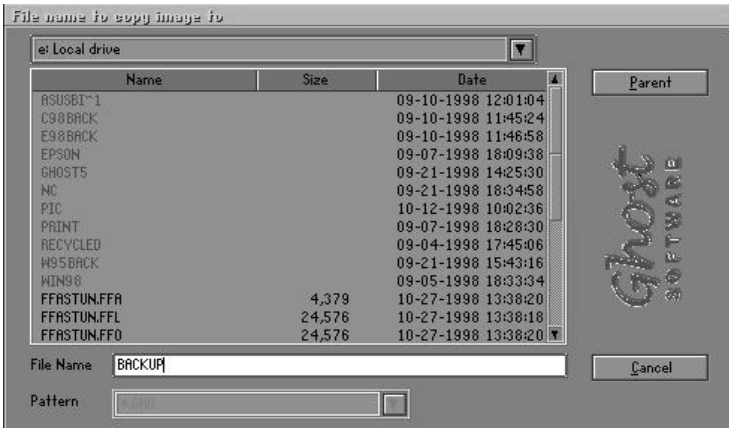

- Select the **Destination drive** of the disk to be restored.

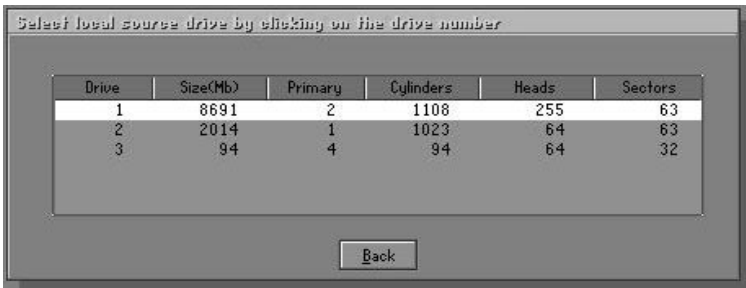

- 3. When restoring disk backup, set the required partition size as shown in the following figure.

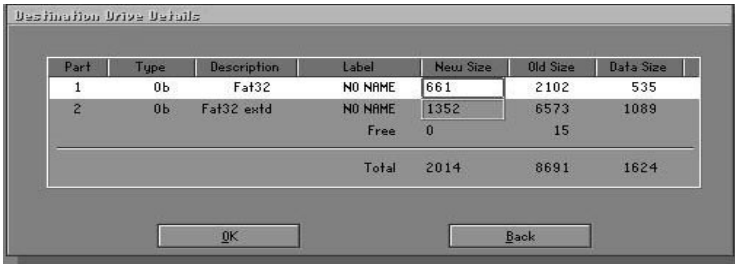

- 4. Click **OK** to display the following confirmation screen. Select **Yes** to start.

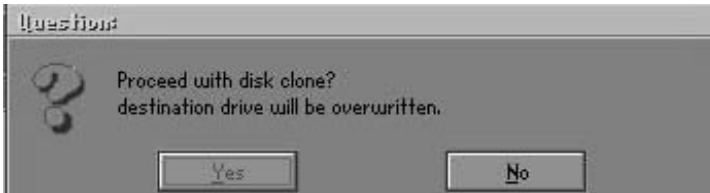

Partition

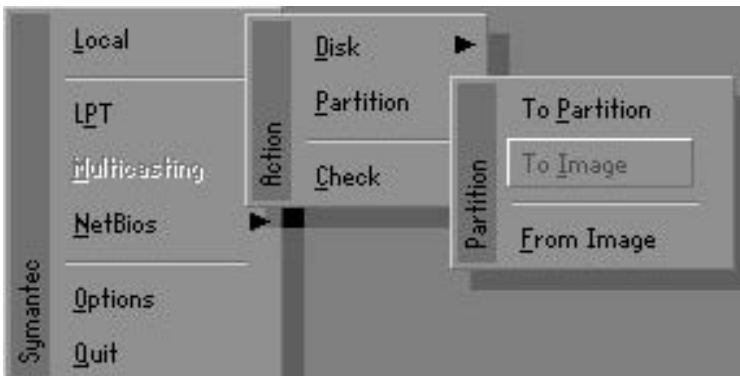

There are 3 partition functions:

- 1. **Partition To Partition** (partition cloning)
- 2. **Partition To Image** (partition backup)
- 3. **Partition From Image** (restore partition)

Partition To Partition (Partition Cloning)

The basic unit for partition cloning is a partition. Refer to disk cloning for the operation method.

Partition To Image (Partition Backup)

- 1. Select the disk to be backed up.

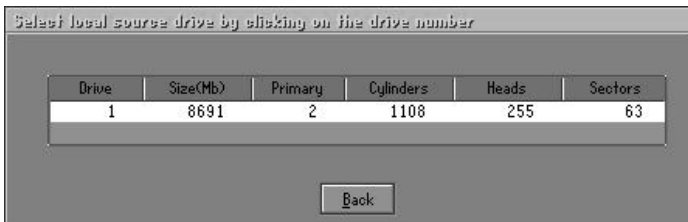

- 2. Select the first partition to be backed up. This is usually where the operating system and programs are stored.



3. Select the path and file name for storing the backup file.

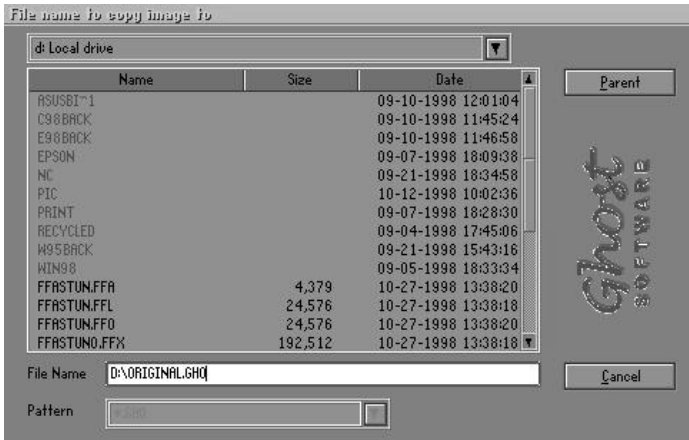

4. Is the file compressed? There are 3 options:

- (1) No: do not compress data during backup
- (2) Fast: Small volume compression
- (3) High: high ratio compression. File can be compressed to its minimum, but this requires longer execution time.

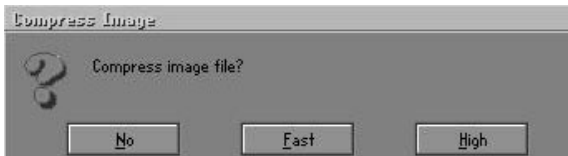

5. During confirmation, select Yes to start performing backup.



Partition From Image (Restore Partition)

1. Select the backup file to be restored.

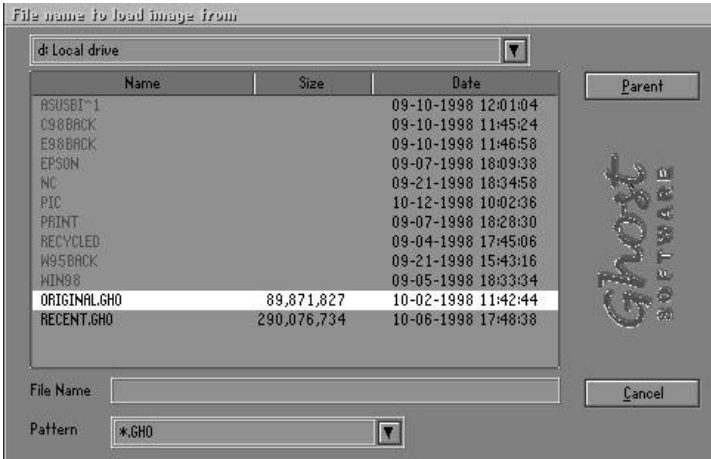

2. Select the source partition.

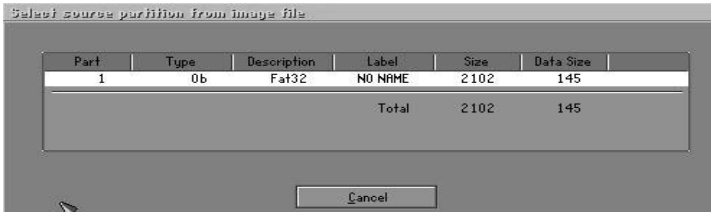

3. Select the disk to be restored.



4. Select the partition to be restored.

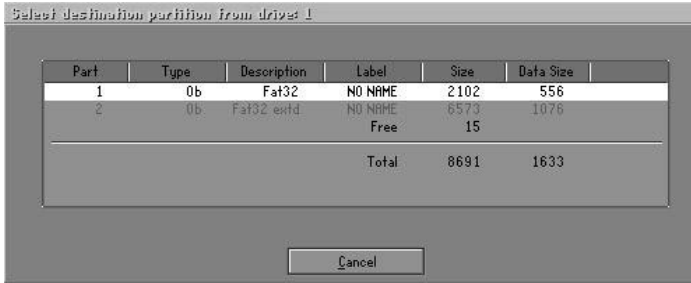

5. Select Yes to start restoring.

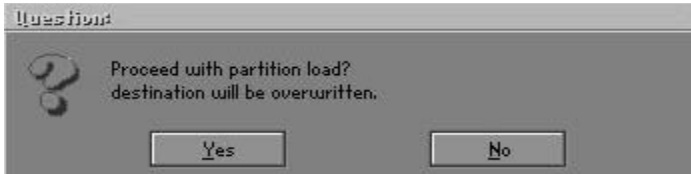

Check

This function checks the hard disk or backup file for backup or restoration error due to FAT or track error.