

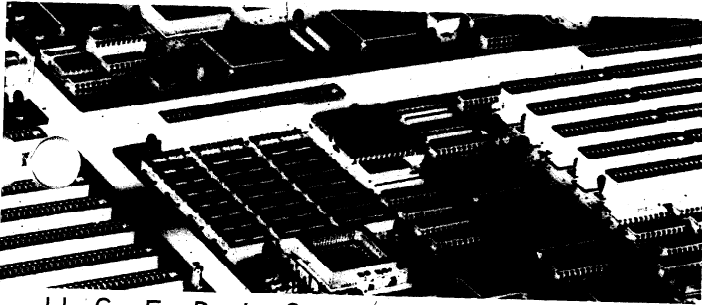

EPA POLLUTION PREVENTER

SA486P AIO-U (STD)



USER'S MANUAL

PLEASE RETURN TO

TECH LIBRARY

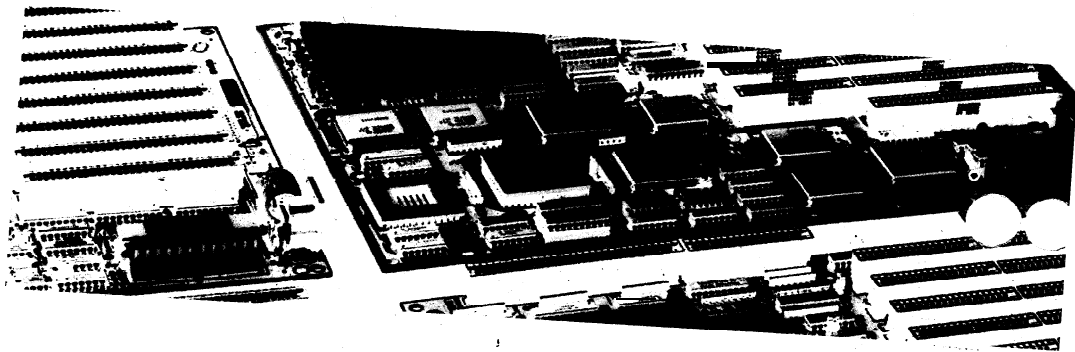

40-012-4171C

Version 1.0

Made in Taiwan



SA486P AIO-U
User's Manual

Trademarks

All brand and product names used in this manual may be trademarks or registered trademarks of their respective companies.

■ CONTENTS

Chapter 1 Introduction

1.1 General Specifications and Features	I-1
---	-----

Chapter 2 Memory Configuration

2.1 System Memory	2-1
2.1.1 DRAM Module Insertion	2-3
2.1.2 DRAM Module Removal	2-3

Chapter 3 Jumper Settings and Connectors

3.1 Jumper Settings	3-1
3.2 Installing on the PCI Slots	3-3
3.3 Mapping the Interrupt Lines	3-4
3.4 Connectors	3-7

Chapter 4 Built-in BIOS Setup Program

4.1 The Standard System Parameter..	4-2
4.2 PCI Device Configuration	4-4
4.3 Advanced Feature Control	4-7
4.4 Quitting SETUP	4-12
4.5 BIOS Errors and Messages	4-13

Chapter 5 Power Management Function

5.1 How Does Power Management Function Work . . .	5-1
---	-----

Appendix A Setting the System Speed

Chapter 1

Introduction

This chapter will cover the general specifications and features of the SA486P AIO-U.

1.1 General Specifications and Features

Specifications

Processor:	80486SX/80487SX/80486DX/80486DX2 P24T/80486DX4
Chipset:	INTEL CDC Cache & DRAM Controller INTEL SIO System <i>I/O</i> Intel DPU Data Path Unit NCR 53C810 PCI SCSI chip FDC 37C665 and IDE Interface
Memory Size:	DRAM Size 2 Banks up to 128MB
Cache Size	512KB MAX
Memory Type :	DRAM = > For 72 pins SIMM socket single or double size EPROM = > 27C010, single BIOS
System BIOS:	Phoenix or AM1 BIOS
Keyboard BIOS:	AMIKH Compatible
Green Function:	Supports Light Green Function which senses the IRQ line and allow user to optimiz power consumption and get utmost performance
Slots:	Support three 16-bit ISA slots Support one shared slot support two PC1 slots
I/O Port:	SCSI HDD Connector Serial Port Connector (COM1)

Serial Port Connector (COM2)
Parallel Port Connector
IDE Interface Connector
FDC Interface Connector
AT Keyboard Connector

Board: 4-Layers
Form Factor: 330mm* 220mm

Features

- Supports 25/33 MHz Intel 486SX/487SX/DX/DX2/P24T/DX4 processors
- Fully synchronous, 25/33 MHz PCI bus capable of supporting bus master
- 128KB 256KB and 512KB cache size using standard SRAM
- Zero wait state write to L2 cache for a cache write hit
- Provides shadows function for the fast access of BIOS
- Supports 2.88M/1.44M/1.2M/720KB 3.5" & 5.25" floppy disk
- Supports Flash ROM Function
- Supports up to two embedded 2.5" or 3.5" hard disk driver
- Supports SCSI HDD
- Compatible with IBM serial & parallel ports
- Compatible with IBM printer port

Chapter 2

Memory Configuration

In this chapter, the **SA486P** AIO-U DRAM configurations are discussed, followed by instructions for DRAM module installation and removal. Users are recommended to read through this chapter before installing or removing memory.

2.1 System Memory

The **SA486P** AIO-U DRAM provides tremendous flexibility to support a number of different on-board DRAM configurations. The on-board DRAM is installed with SIMM (Single-In-Line Memory Module). There are four banks of DRAM module capable of supporting 2MB up to 128MB of **on-board** memory.

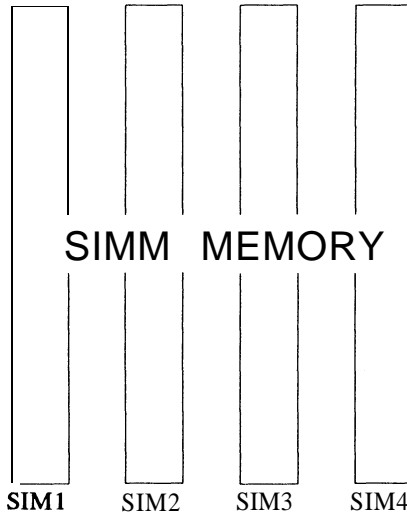

The location and layout of all the memory is illustrated below and shown in Figure 3.1.

The following table lists all the possible DRAM module combinations and the total memory amount for each option.

SIM 1, 2	Type	SIM 3, 4	Type	Memory Amount
256K*36	Single			2MB
256K*36	Single	256K*36	Single	4MB
256K*36	Single	512K*36	Dual	6MB
256K*36	Single	1M*36	Single	1 OMB
256K*36	Single	2M*36	Dual	18MB
256K*36	Single	4M*36	Single	34MB
256K*36	Single	8M*36	Dual	66MB
512K*36	Dual			4MB
512K*36	Dual	256K*36	Single	6MB
512K*36	Dual	512K*36	Dual	8MB
512K*36	Dual	1M*36	Single	12MB
512K*36	Dual	2M*36	Dual	20MB
512K*36	Dual	4M*36	Single	36MB
512K*36	Dual	8M*36	Dual	68MB
1M*36	Single			8MB
1 M*36	Single	256K*36	Single	10MB
1M*36	Single	512K*36	Dual	12MB
1 M*36	Single	1M*36	Single	16MB
1 M*36	Single	2M*36	Dual	24MB
1M*36	Single	4M*36	Single	40MB
1 M*36	Single	8M*36	Dual	72MB
2M*36	Dual			16MB
2M*36	Dual	256K*36	Single	18MB
2M*36	Dual	512K*36	Dual	20MB
2M*36	Dual	1M*36	Single	24MB
2M*36	Dual	2M*36	Dual	32MB
2M*36	Dual	4M*36	Single	48MB
2M*36	Dual	8M*36	Dual	80MB
4M*36	Single			32MB
4M*36	Single	256K*36	Single	34MB
4M*36	Single	512K*36	Dual	36MB
4M*36	Single	1M*36	Single	40MB
4M*36	Single	2M*36	Dual	48MB

SIM 1,2	Type	SIM 3,4	Type	Memory Amount
4M*36	Single	4M*36	Single	64MB
4M*36	Single	8M*36	Dual	96MB
8M*36	Dual			64MB
8M*36	Dual	256K*36	Single	66MB
8M*36	Dual	512K*36	Dual	68MB
8M*36	Dual	1M*36	Single	72MB
8M*36	Dual	2M*36	Dual	80MB
8M*36	Dual	4M*36	Single	96MB
8M*36	Dual	8M*36	Dual	128MB

Cache Memory Subsystem

Cache Size	TAG RAM (U29)	Cache Bank 0 (U48....U51)	Cache Bank 1 (U43....U46)
128KB	8Kx8	32Kx8	Open
256KB	32Kx8	32Kx8	32Kx8
512KB	32Kx8	128Kx8	Open

2.1.1 DRAM Module Insertion

The **SIMMs** must be seated on the sockets as firmly as possible, and, because of the fragility of the slot, you must be careful when inserting or removing the module.

1. Align the module so that the pin **1** marking and corner notch of the module correspond to the SIMM socket pin 1 marking at the rear of the board. The module can fit in the socket one way only. Do not force it!
2. Push the module against the clip arms with your thumbs until a “clicking” sound is heard; the little plastic tabs appear in the latching holes on the RAM module board, and the clip arms fully grab the module board.

2.1.2 DRAM Module Removal

If possible, use a SIMM extraction tool; otherwise use the following method:

1. Carefully use your thumbs to bend outward the plastic tab ends on both sides of the slot.
2. The RAM module board will be automatically ejected off the clip arms.
3. Take it out of the socket.
4. Repeat steps 1 through 3 to release the other RAM modules.

Chapter 3

Jumper Settings and Connectors

This chapter will assist you in setting up the **SA486P AIO-U** before you install it in a system case. If your **SA486P AIO-U** has already been installed and you do not wish to change the configuration settings, you can skip over this section.

3.1 Jumper Settings

The **SA486P AIO-U** has several jumper switches that must be set to define a system configuration. These switches are 2-pin, 3-pin, 4-pin components on the mainboard. They are turned off and on by placing or removing a cover cap over the pins. This is called a short or closed jumper. All jumpers must be set to one of the possible two settings.

Figure 3.1 on the following page shows the location of the jumpers and connectors.

Board Layout

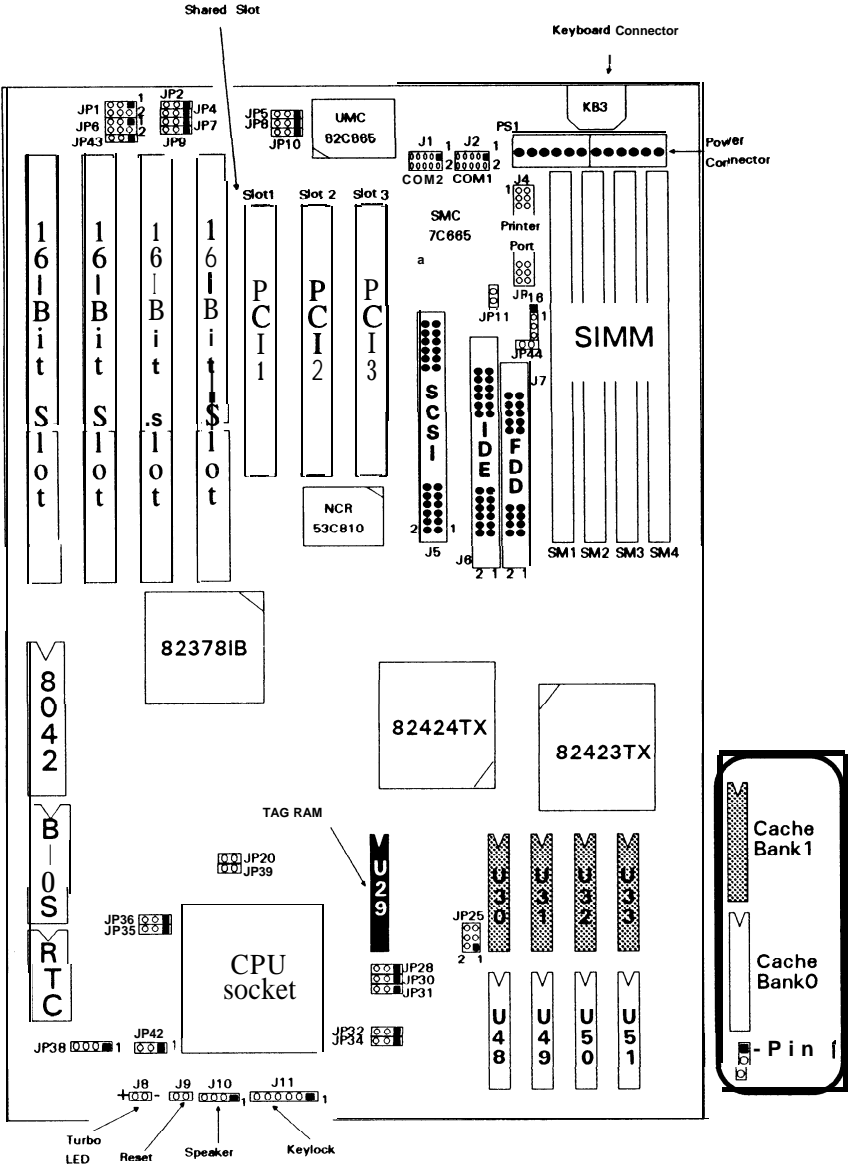

3.2 Installing on the PCI Slots

There are two Peripheral Components Interconnect (**PCI**) slots and one **PCI** shared slot on the **SA486P** AIO-U. The following diagram shows the proper sequence of the **PCI** slots on-board.

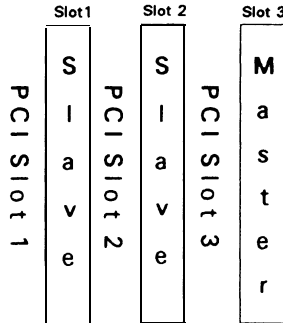

When installing an add-on card onto a **PCI** slot, the following steps should be taken:

1. Remember the **PCI** slot number where the **PCI** add-on card was installed. This is an important step in configuring the add-on card.

Note: **PCI** master add-on cards **MUST** be installed onto **PCI** master slot on the **SA486P** AIO-U. **PCI** slave add-on cards may be installed onto any **PCI** slot regardless of whether its a master or a slave slot.

2. Check the interrupt line of the **PCI** add-on card and the **SA486P** AIO-U-mainboard. This step determines the **IRQ** into which the add-on card's interrupt line matches. For instance, if you install an **add-on** card with its interrupt line at **INTA#** on **PCI** slot 1, you should locate the corresponding **INTA#** settings of the **SA486P** AIO-U.

Important: Set the mainboard jumper corresponding to the chosen **IRQ**.

3. The final step requires the BIOS mapping of the **PCI** slot where the **PCI** add-on card is installed onto. Configure the **PCI** slot setting of the add-on card in the BIOS program and several other parameters (i.e., latency Time, **IRQ** choice, Master Enabled, etc.) depending on the installed system BIOS on your mainboard.

The add-on card is now completely configured and ready for use.

3.3 Mapping the Interrupt Lines

To determine the IRQ and map the interrupt lines on the SA486P AIO-U, refer to the following diagram.

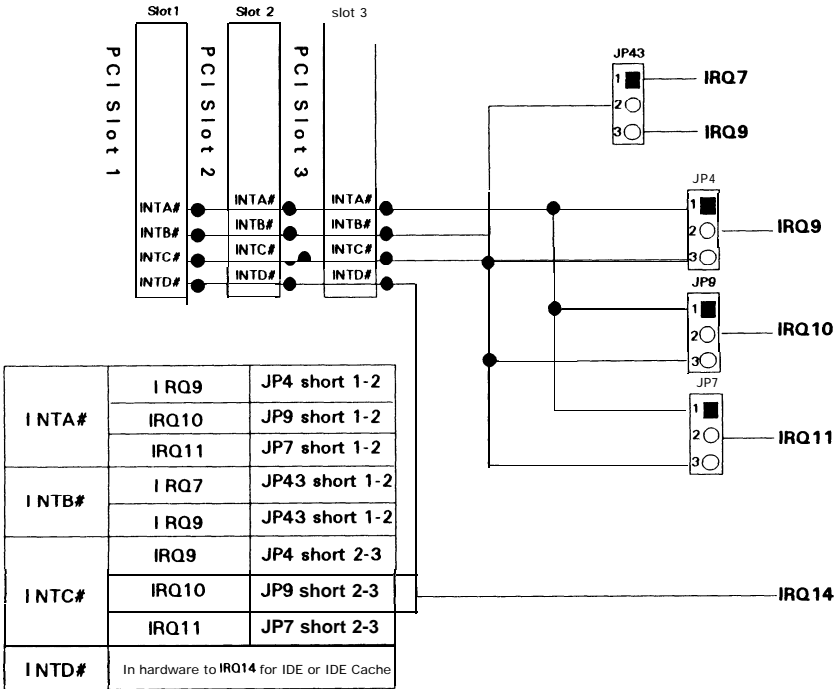

For example: If JP7 is configured as Short 1-2, INTA# is defined at IRQ1 1.

1. Only INTA# on the SA486P AIO-U supports share interrupt.
2. During IRQ setup, there are two **check points that must be followed** namely the PCI add-on card's INTX#, and the corresponding INTX# of the mainboard.
3. If the add-on card installed is an IDE or an IDE Cache, INTX# setting for the PCI IDE Cache card should be INTD#.

The following table summarizes the function and settings of each jumper on the SA486P AIO-U.

Function		Jumper Settings
Type of CPU used	486DX/DX2, 487SX,P24T (Non-SL type)	JP38 short 1-2, 3-4 JP39 open
	486DX/DX2, 487SX, P24T (SL type)	JP38 short 1-2, 3-4 JP39 short
	80486DX4	JP38 short 1-2, 3-4 JP39 short
	486SX (Non-SL type)	JP38 short 2-3 JP39 open
	486SX (SL type)	JP38 short 2-3 JP39 short
80486DX4 Clock Multiplier Select	Frequency 3 Times (default)	JP42 open
	Frequency 2 Times	JP42 short 2-3
CPU Speed Select	25MHz	JP20 short JP34 short 2-3
	33MHz	JP20 open JP34 short 1-2
BIOS	Flash ROM	JP2 short 1-2
	EPROM BIOS (default)	JP2 short 2-3
Power Management Function IRQ Sense Select	1. Choose one from the following: IRQ5 IRQ9 IRQ14 (default)	JP1 short 1-2 JP1 short 3-4 JP1 short 5-6
	2. Choose one from the following: IRQ7 (default) IRQ10 IRQ1 1	JP6 short 1-2 JP6 short 3-4 JP6 short 5-6
Cache Memory Setting	Installed (default)	JP31 short 1-2
	Not Installed	JP31 short 2-3
	Wait state =0 W.S.(default)	JP32 short 1-2
	Wait state = 1 .W.S.	JP32 short 2-3
	128KB	JP25 short 1-2 JP28 short 2-3 JP30 short 1-2
	256KB (default)	JP25 short 1-2, 3-4 JP28 short 1-2 JP30 short 2-3
	512KB	JP25 short 1-2, 3-4, 5-6 JP28 short 1-2 JP30 short 1-2

Function		Jumper Settings
PCI IRQ Select		
INTA#	IRQ9 IRQ10 IRQ11 (default)	JP4 short 1-2 JP9 short 1-2 JP7 short 1-2
INTB#	IRQ7 IRQ9 (default)	JP43 short 1-2 JP43 short 2-3
INTC#	IRQ9 IRQ10 (default) IRQ11	JP4 short 2-3 JP9 short 2-3 JP7 short 2-3
Parallel Port Interrupt/DMA Request Select	IRQ5	JP10 short 1-2
	IRQ7 (default)	JP10 short 2-3
	DACK1	JP8 short 1-2
	DACK3 (default)	JP8 short 2-3
	DRQ1	JP5 short 1-2
CPU Power 5V/3.3V select	+ 5V	JP35 short 1-2 (default) JP36 short 1-2 (default)
	+ 3.3V	JP35 short 2-3 JP36 short 2-3

Note: *1. Due to the chip set function currently, the SATURN I does not support SMM mode.*

3.4 Connectors

There are several connectors located on the SA486P AIO-U. They are used to connect with some peripheral devices to enhance the operating performance of the system.

Refer to Figure 3.1 for the positions of all the connectors on the mainboard. Their functions are listed below.

Connector	Function
J1	COM2 Port
J2	COM1 port
J4	Printer Port
J5	SCSI Connector
J6	IDE Connector
J7	FDD Connector
J8	Turbo LED
J9	Reset Switch
J10	Speaker Connector
J11	Power LED/Keylock Connector
JP16	IDE HDD LED
KB3	AT Keyboard Connector
J P44	SCSI HDD LED
PS1	Power Connector

Chapter 4

Built-in BIOS Setup Program

BIOS Setup Utility

Use the Phoenix BIOS Setup program to record changes in your hardware and to control its special features. The Setup program uses a number of menus in which you can specify the changes and turn the special features to on or off.

To display the BIOS Setup utility, take the following steps:

1. **Turn on** your system. The BIOS displays this message:
There is no device available. Press the <F1> key to retry boot, <F2> for setup utility:
2. Press the <F2 > key and the following screen will appear.

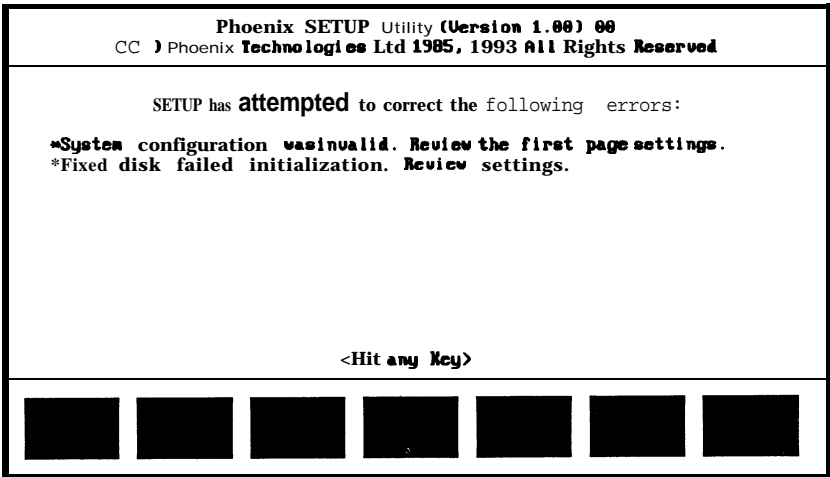

Figure 4-1. Summary Screen of Errors Detected

Note: Pressing the <Ctrl><Alt><S> key combination after the memory test will also allow access into the SEW? Utility program.

4.1 The Standard System Parameter

Upon hitting any key shown in the previous screen, the screen will automatically display the Standard System Parameters page as shown below.

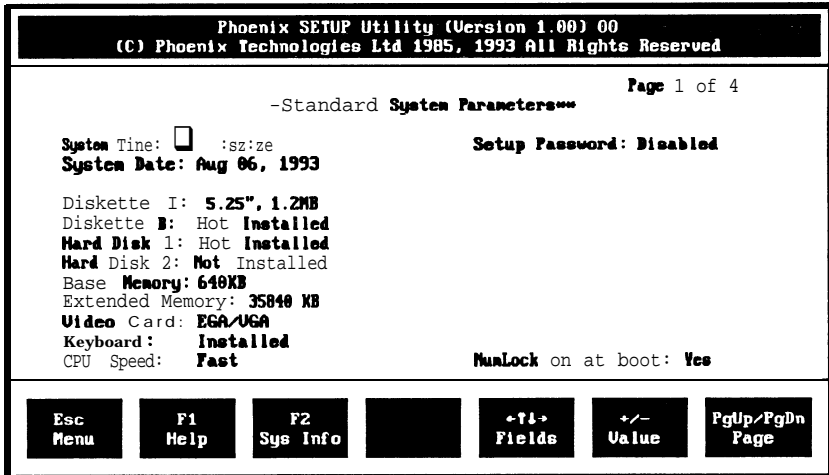

Figure 4-2. Standard System Parameters Screen

Note: *On-screen instructions at the bottom of each screen explain how to use the program.*

The Standard System Parameters allows checking or modification of general configuration information.

SystemTime - includes hour, minutes, and seconds which may be set on a 24-hour clock

System Date - allows manual setting of the electronic calendar on the main-board.

Diskette A:/B:- specify the capacity and format of the floppy drives installed in your system.

Hard Disk 1/2 - specify the physical and electronic properties of the standard hard disk drives installed. Relevant specifications include the number of cylinders, heads, write pre-compensation time, read/write head landing zone, and number of sectors per track.

Base Memory and Extended Memory - display important information about your system which includes the base and extended memory sizes. They are updated automatically by the SETUP Utility program according to the status detected by the BIOS self-test. This section of the Standard System Parameters screen is for viewing purpose only and manual modifications are not allowed.

Video Card - specifies the type of video adapter installed.

Keyboard - used to select “**Installed**” or “**Not Installed**” for the keyboard during the Power On Self Test. Normally, it is set as “**Installed**”

CPU Speed - selects the speed rate of the CPU which the BIOS uses in setting the microprocessor clock every boot process.

Setup Password - determines whether or not the password security will be required each time you enter SETUP.

NumLock at boot - sets the Num Lock key to either on or off during system boot-up.

It is highly recommended that you list down all the values within the SETUP Utility program before marking any changes. Doing so will save a lot of time restoring the system back in the event of a configuration memory loss.

Select an item on the screen by using the < Up > and < Down > arrow keys. To scroll through the selection on each item, use the < + > and < - > keys.

Pressing the < F1 > key will provide you with the on-line help of the current screen/item selected. Pressing < ESC > will provide you with a sub-menu that gives the option of continuing with SETUP < ESC >, saving the values then exiting and rebooting the system < F4 >, loading the default values for all the pages of the SETUP Utility program < F5 >, or aborting SETUP without saving the values < F6 >.

The < F2 > key provides you with the current system information screen which is for viewing purposes only. Manual modifications are not allowed within the system information screen.

4.2 PCI Device Configuration

Once the modifications on the Standard System Parameters are done, press the <PgDn> key and the PCI Device Configuration screen will appear as shown below.

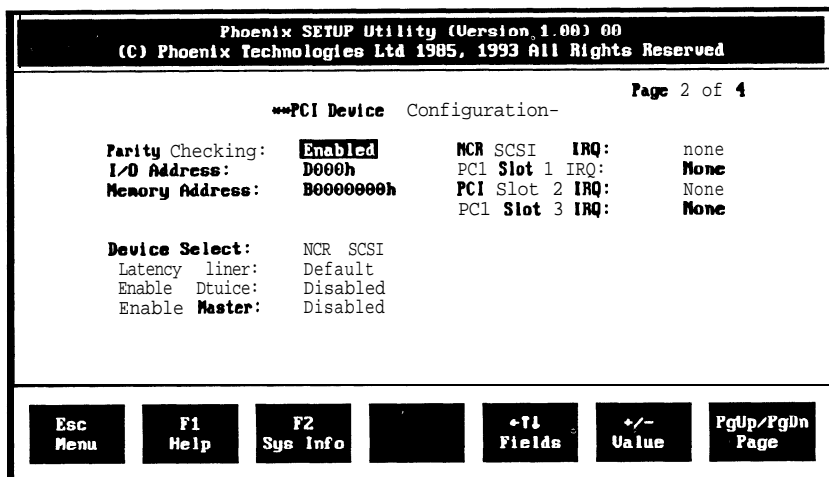

Note: *The contents of this menu depends on the chipset installed on your mainboard. Consult your dealer or the <F1> help screens before changing any of the items. If you set them incorrectly, they may cause the system to malfunction.*

Parity Checking - allows parity checking on the PCI devices. The available options are:

- Enabled (default)
- Disabled

I/O Address - a user-definable address that specifies the I/O port number wherein the BIOS will start from when assigning sequential I/O ports to the PCI devices.

Memory Address - a userdefmeable address that assigns the value(in 64KB boundary) of the four high-order digits which specify the starting memory address for the BIOS to designate the sequential I/O ports to the PCI device.

Device Select - determines which **PCI** device is being displayed in the Latency Timer, Enable Time, and Enable Master fields. The available options are:

- NCR SCSI (default)
- PCI Slot 1
- PCI Slot 2
- PCI Slot 3**

Latency Timer - “**Default**” allows the **PCI** device to use the built-in (power-on) default setting. “**Override**” specifies the hexadecimal value with which the BIOS should program the device’s latency timer. The available options are:

- Override options from **00h** to **F8h**
- Default (Override =**40h**)

Enable Device - *enables* or *disables* the device specified on the Device Select option. The available options are:

- Enabled
- Disabled (default)

Enable Master - allows you to set the device on the Device Select as a **PCI** Master when “**enabled**”. Note that only **a** number of devices may be set as masters. The available options are:

- Enabled
- Disabled (default)

NCR SCSI/PCI Slots 1121314 IRQ - allows assignment of a hardware interrupt (IRQ), that matches any jumper or dip switch settings of a PCI device. The available options are:

- IRQ3
- IRQ4
- IRQ5
- IRQ6
- IRQ7
- IRQ9
- IRQ10
- IRQ11
- ◁ IRQ12
- IRQ14
- IRQ15
- None (default)

4.3 Advanced Feature Control

Press the <PgDn> key after modifying the settings in the PCI Device Configuration screen and the third page of the program, the Advanced Feature Control's first menu, will be displayed on the screen.

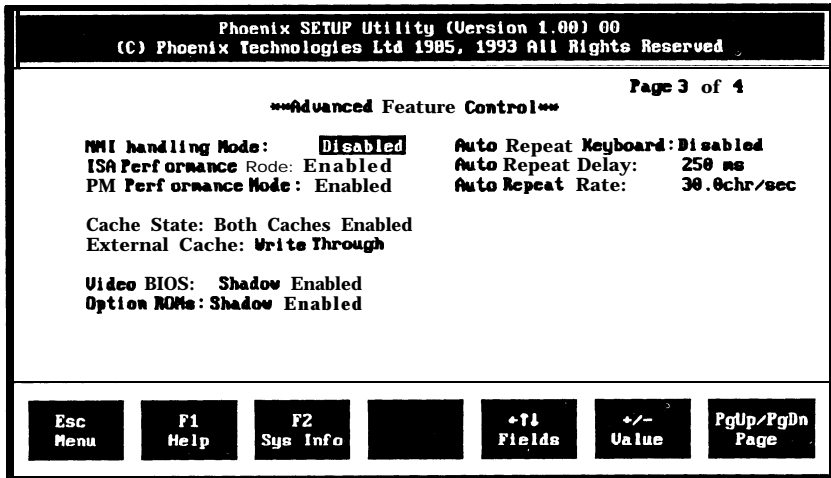

Note: *The contents of this menu depends on the chipset installed on your motherboard, and chipsets vary widely. Consult your dealer or the <F1> help screens before changing the items on this menu. If you set them incorrectly, they may cause your system to malfunction.*

NMI Handling Mode - provides more detailed error handling when a non-mask interrupt (NMI) occurs. The available options are:

- Enabled (default)
- Disabled

ISA Performance Mode - allows the ISA bus accesses to perform at a fast rate. However, problems may arise if the system contains slow ISA devices. The available options are:

- Enabled (default)
- Disabled

DRAM Performance Mode - maximizes the DRAM performance of the system. The available options are:

- Enabled (default)
- Disabled

Cache State - enables the internal **8KB** cache of the **80486** CPU and the on-board secondary cache when set to "Both **Caches Enabled**" (default). Choosing "**80486 Cache Enabled**" will only enable the internal cache of the 80486 CPU. "**Disabled**" turns off both internal/external memory.

External Cache - provides External Cache Read/Write method. This version only supports **Write Through**.

Video BIOS - enables the system shadowing and achieve the best performance of the system. The available options are:

- Shadow Enabled (default)
- Shadow Disabled

Options ROMs - enables the shadowing on the ISA option ROMs and achieve the best performance of the system. The available options are:

- Shadow Enabled
- Shadow Disabled (default)

Auto Repeat Keyboard - enables or disables the typematic rate of the keyboard. The available options are:

- Disabled (default)
- Enabled

Auto Repeat Delay - specifies the time in milliseconds for an autorepeat to occur. The available options are:

- 250 ms (default)
- 500 ms
- 750ms
- 1000 ms

Auto Repeat Rate - specifies the rate (characters per second) at which the autorepeat is expected to occur. This option's default value is 30.0 chr/sec.

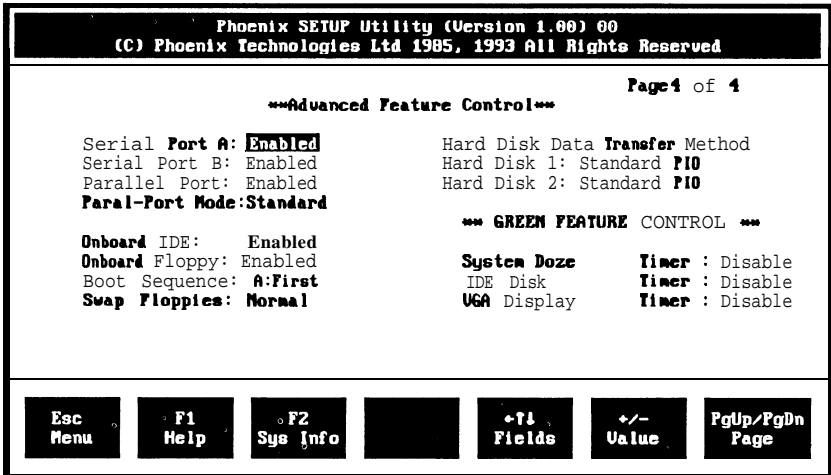

To enter the Advanced Feature Control's second menu, simply press the < PgDn > key again after modifications are done on the first menu and the screen will show the following screen.

When saving the new values, press the < ESC > until a pop-up menu appears on the right side of the screen. Press the < F4 > key to save the changes made and the system will automatically exit the Setup utility program and reboot.

Serial Port **A.B-** disables the on board serial port , if you have an adapter card in your system which uses the I/O ports or the IRQ be used by this port. Serial Port **A** uses the I/O ports **3F8h-3FFh** and **IRQ4**, serial port B uses I/O ports **2F8h-2FFh** and **IRQ3**. The available options are :

- Enabled (default)
- Disabled

Parallel Port - disables the on board parallel port if you have an adapter card in your system which uses the I/O ports **3BCh-3BFh** or the **IRQ7**. The available options are :

- Enabled (default)
- Disabled

Paral_ Port Mode - In “ECP & EPP” mode, EPP can select through the ECR register of ECP mode **100**. In SPP can be selected through the ECR register as mode **000**. The available options are:

- Standard (default)
- EPP & SPP
- ECP mode
- EPP & ECP

On board IDE - enables the on board primary IDE interface when enabled this interface will reside at the normal address for hard disk 1 (**1FQh-1F7h**). The available options are:

- Enabled (default)
- Disabled

On board Floppy - enables the on board floppy interface.

- Enabled (default)
- Disabled

Boot Sequence - selects the drive where the system would search for the operating system to run with. The available options are:

- A: First (default)
- C: First

Swap Floppies - “Swapped” will effectively change the A: drive to B: and the B: to A: drive. “Normal” (default) sets the floppy drives in their default states.

Hard Disk Data Transfer Method

Hard Disk 1/2 - allows you to control how data is transferred from the hard disk controller to the system memory. The available options are:

- Standard **PIO** (default) -uses the CPU to copy one sector at a time.
- 2/4/8/16 Sector Block PIO** - uses the CPU to copy multiple sectors at a time.
- DMA** - Speeds up the data transfer compared to when using the CPU.
- Automatic Selection (reserved)

Green Feature Control

System Doze Timer - specifies the length of time after which the BIOS will turn-off the IDE HDD spin motor, blank-off the VGA or turn-off the DPMS monitor, and slow down the CPU speed to **8MHz**. The available options are:

- Disable (default)
- 1 min.
- 5 min. to 60 min. (at increments of 5 minutes)

IDE Disk Timer - specifies the length of time after which the BIOS will turn-off the IDE HDD spin motor. The available options are:

- Disable (default)
- 1 to 10 minutes

VGA Display Timer - specifies the length of time after which the BIOS; will **blank-off** the VGA or turn-off the DPMS **monitor**. The available options are:

- Disable (default)
- 1 to 10 minutes

Note: *If it uses UNIX or Netware OS, doesn't enable green function.*

4.4 Quitting SETUP

After all modifications are made in any of the SETUP pages, press the <ESC> key until a pop-up menu appears on the right side of the screen.

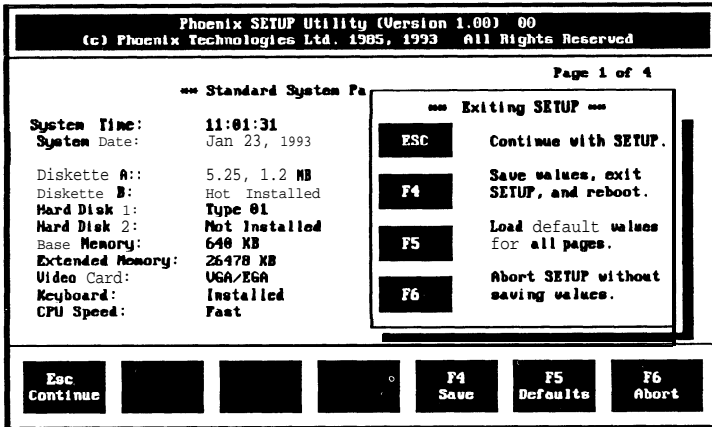

Figure 4-6. Write to CMOS and Exit Screen

Press <F4> to save the values then exiting and reboot the system. Pressing <F5> loads the default value for all the pages of the SETUP Utility program. Once the <F6> key is pressed, the changes made are aborted and the program exits then reboots the system.

4.5 BIOS Errors and Messages

After entering the SETUP choices, the system will reboot. The SETUP summary and system information will appear on screen along with messages. These may include ERROR messages concerning the system or SETUP.

Phoenix BIOS performs various diagnostic tests at the time the system is turned on. Whenever an error is encountered during these tests, error codes will be displayed on the screen. The following table lists the error codes and their respective meanings.

Error Codes	Meaning
002h TP_VERIFY_REAL	If the CPU is in protected mode, turn on A20 and pulse the reset line, forcing a shutdown 0.
004h TP_GET_CPU_TYPE	On a cold boot, save the CPU type information value in the CMOS.
006h TP_HW_INIT	Reset the DMA controllers. Disable the videos. Clear any pending interrupts from the real time clock. Setup port B register.
008h TP_CS_INT	Initialize chipset control registers to power-on defaults.
00Ah TP_SET_INT_POST	Set a bit in the CMOS that indicates that we are in POST. This bit is used to determine if the current configuration causes the BIOS to hang. If so, the BIOS, on the text POST, will use default values for its configuration.
00Ch TP_IO_INIT	Initialize IO module control registers.
00Eh TP_CACHE_INIT	External CPU caches are initialized. Cache registers are set to default. Does implementaion specific cache initialization.
010h TP PM INIT 012h TP-USERPATCHO 014h TP-8742 INIT	Verify whether or not the 8742 is responding.
016h TP_CHECKSUM	Verify that the ROM BIOS checksums to zero.
018 h TP_TIMER_INIT	Initialize all three of the 8254 timers.
01Ah TP_DMA_INIT	Initialize DMA command register. Initialize 8 DMA channels.
01 Ch TP-RESET_PIC	Initialize the 8259 interrupt controller to: ICW4 needed, Cascade, and edge-triggered mode.

Error Codes	Meaning
020h TP_REFRESH	Verify that DRAM refresh is operating by polling the refresh bit in PORTB.
022h TP_8742_TEST	Verify the 8742 is responding. Send a self-test command to the 8742 and wait for results. Also read the switch inputs from the 8742 and write the keyboard controller command byte.
024h TP_SET_HUGE_ES	Make a huge (4 GByte) ES segment.
026h TP_ENABLE_A20	Enable the A20 address line.
00AhTP_SET IN-POST	Set a bit in the CMOS that indicates that we are in POST. This bit is used to determine if the current configuration cause the BIOS to hang. If so, the BIOS, on the next POST, will use default values for its configuration.
028h TP_SIZE_RAM	Determine DRAM size and configure the chipset accordingly.
02Ah TP_ZERO_BASE	Zero the first 64K of RAM.
02Ch TP_ADDR_TEST	Test address lines of the RAM.
02Eh TP-BASERAML	Perform a memory test on the first 64K bank of memory. The memory test consists of a chip address line test and a ram test.
030h TP BASERAMH 032h TP-COMPUTE SPEED	Find the true MHz value.
034h TP_CMOS_TEST	Clear the CMOS diagnostic byte (register E). Check the real time clock and verify the battery has not lost power. Checksum the CMOS and verify it has not been corrupted.
036h TPCHK RESUME 038h TP_SYS_SHADOW 03Ah TP_CACHE AUTO	External cache is autosized and its configuration saved memory for enabling later in POST.
03Ch TP_ADV_CS_CONFIG	Configure advanced cache features. Configuration external cache's configurable parameters (if any).
03Eh TP_READ_HW	Read the hardware configuration from the keyboard controller.
040h TP_SPEED	Set the power-on speed of the system to the rate determined by CMOS. If CMOS is invalid, use a conservative speed.
042h TP_VECTOR_INIT	Initialize interrupt vectors 0 thru 77h to the BIOS general interrupt handler.
044h TP_SET_BIOS INIT	Initialize interrupt vectors 0 thru 20h to proper values from the BIOS Interrupt Table.

Error Codes	Meaning
046h TP_COPYRIGHT	Verify the copyright message checksum.
048h TP_CONFIG	Verify video configuration.
04Ah TP_VIDEO	Initialize both the monochrome and color graphics video adapters.
04Ch TP_VID_SHADOW 04Eh TP-CR_DISPLAY	Display the copyright message.
050h TP_CPU_DISPLAY	Display CPU type and speed.
052h TP_KB_TEST	Test for the self-test code if the system is being started from a cold start. When powered, the keyboard performs a self test and seconds an AA if successful.
054h TP_KEY_CLICK	Initialize keystroke clicker during POST.
056h TP_ENABLE_KB	Enable the keyboard.
058h TP_HOT_INT	Test for any hot interrupts. That is, any unexpected interrupts. First do an STI for hot interrupts. Secondly, test the NMI for an unexpected interrupt. Thirdly, enable the parity checkers and read from memory, checking for an unexpected interrupt.
05Ah TP_DISPLAY_F2	Display "Press F2 for Setup" prompt.
05Ch TP_MEMORY_TEST	Determine and test the amount of memory available. Save the total memory size in the BIOS variable called bdaMemory Size.
05Eh TPBASE-ADDR	Perform an address test on the base memory. The following address lines are tested based on the memory size.
060h TP_EXT_MEMORY	Determine and test the amount of extended memory available . Save the total extended memory size in the CMOS at cmosExtended .
062h TP_EXT_ADDR	Perform an address line test on A0 to the amount of memory available. This test is dependent on the processor, since the test will vary depending on the width of memory (16 or 32 bits). This test will also use A20 as the skew address to prevent corruption of the system memory.
068h TP_CACHE_CONFIG	External cache and CPU cache, if present, are enabled. Non-cacheable regions are configured if necessary.
06Ah TP_DISP_CACHE	Display cache size on the screen if it is non-zero.

Error Codes	Meaning
06Ch TP_DISP_SHADOWS	Display BIOS shadow status.
06Eh TP-DISP_NONDISP	Display the starting offset of the non-disposable section of the BIOS.
070h TP_ERROR_MSGS	Check flags in CMOS and in the BIOS data area to see if any errors have been detected during POST. If so, display error messages on the screen.
072h TP_TEST_CONFIG	Check status bits to see if configuration problems were detected. If so, display error messages on the screen.
074h TP_RTC_TEST	Verify the Real Time Clock is running if the battery has not lost power. If the RTC is not running or the battery has lost power, set the incorrect time bit in Register E of the CMOS.
076h TP_KEYBOARD	Check status bits to see if any keyboard related failures were detected. If so, display error messages on the screen.
078h TP_STUCK_KEY	Check for any stuck keys on the keyboard. If so, display error message on the screen.
07Ah TP_KEYLOCK	Enable Keyboard locking.
07Ch TP_HW_INTS	Initialize hardware interrupt vectors.
07Eh TP_COPROC	This is the coprocessor initialization test.
080h TP IO BEFORE 082h TP-RS232	Test and identify RS232 ports.
084h TP_LPT	Test and identify parallel ports.
086h TP IO AFTER 088h TP-BIOS INIT	Initialize timeouts, key buffer, soft reset flag.
08Ah TP_INIT_EXT_BDA	Initialize extended BIOS data area and initialize the mouse.
08Ch TP_FLOPPY	Initialize both the floppy disks and display an error message if failure was detected. Both drives are checked so the appropriate diskette types are established in the BIOS data area.
08Eh TP-AUTOTYPE	Autotype hard disks.
090h TP_FDISK	If the CMOS RAM is valid and intact, and fixed disks are defined then call the fixed disk init routine to initialize the fixed disk system and take over the appropriate interrupt vectors.
092h TP_USERPATCH 094h TP-DISABLE A20	Disable the A20 address line.
096h TP_CLEAR HUGE-ES 098h TP_ROM_SCAN	Scan for ROM BIOS extensions.

Error Codes	Meaning
09Eh TP_IRQS	Enable the proper hardware interrupt.
0A0h TP_TIME_OF_DAY	Set time of day.
0A2h TP_KEYLOCK_TEST	Setup Num-Lock indicator. Display a message if key switch is locked
0A4h TP_KEY_RATE	Initialize keyboard typematic rate.
0A6h TP_KEY_AUTOPARK	Initialize hard disk autoparking.
0A8h TP_ERASE_F2	Remove "Press F2 " prompt from the screen.
0AAh TP_SCAN_FOR F2	Scan the keyboard buffer for F2 keystrokes.
0ACh TP_SETUP_CHECK	Check to see if SETUP should be executed.
0AEh TP-CLEAR-BOOT	Clear ConfigFailedBit and InPostBit in CMOS.
0B0h TP-ERROR-CHECK	Check for POST errors.
0B2h TP_POST_DONE	Set/clear status bits to reflect POST complete.
0B4h TP_ONE_BEEP	Beep once quickly.
0B6h TP_PASSWORD	Query for password before boot.
0B8h TP_SYSTEM_INIT	Clear out the GDT .
0BAh TP_INIT_SS	Initialize the screen saver.
0BCh TP_PARITY	Clear the parity error latch.
0BEh TP_CLEAR_SCREEN	Clear the screen.
0C0h TP_INT19	Interrupt 19 boot loader.
0D0h TP_EXCEPTION 0D2h TP_UNKNOWN_INT	In the event that an interrupt occurs before the interrupt vectors have been initialized, this generalized interrupt handler will try to determine if the interrupt caused was an 8259 interrupt, and if so which one. If the interrupt is unknown, then InterruptFlag will be FF, otherwise it will contain the IRQ number that occurred.
0D4h TP_PENDING_INTS	Clear pending timer and keyboard interrupts, and transfer control to the double word address located at RomCheck .
0D6h TP_SHUTDOWN_5 0D8h TP_SHUTDOWN_ERROR 0DAh TP_EBM	Return from Extended Block MOve .

Chapter 5

Power Management Function

The Power Management Function included in the SA486P AIO-U is an architecture designed to allow programming of the monitored system events of six devices. It is also aimed at reducing the system's power consumption during idle stages.

5.1 How Does Power Management Function Work?

Power Management Function implements a PMU (Power Management Unit) handler that monitors the interrupt signals of different devices (i.e. ,keyboard.floppy **diskette**,**hard** disk,serial **mouse**,**option** card,etc.) from the interrupt events detector.Once interrupt **signals**,in a period of time specified by the user,are not accessed from the devices to the PMU **handler**,the system will automatically be put into sleep **mode**.The diagram below describes the operation.

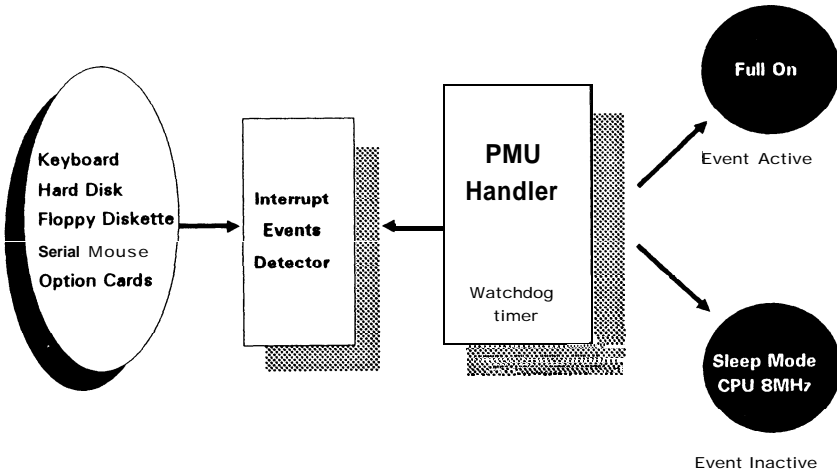

Appendix A

Setting the System Speed

There are two methods to select the system processing speed. You can change the speed during operation while you are working with your application program.

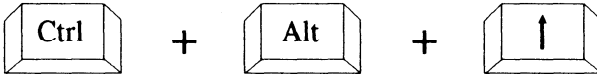

■ High Speed

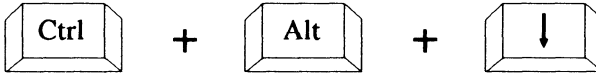

■ Low Speed

* "+" means one must press the keys simultaneously.