

**VIA MVP3**  
**AT**  
**SYSTEM BOARD**

**OPERATION MANUAL**

## TABLE OF CONTENTS

Chapter & Section	Page
1. INTRODUCTION .....	1-1
1.1 SYSTEM OVERVIEW .....	1-1
1.2 SYSTEM BOARD LAYOUT .....	1-2
2. FEATURES .....	2-1
2.1 MAINBOARD SPECIFICATIONS .....	2-1
3. HARDWARE SETUP .....	3-1
3.1 UNPACKING.....	3-1
3.2 HARDWARE CONFIGURATION.....	3-2
3.2.1 CONNECTORS.....	3-2
3.2.2 JUMPERS .....	3-9
3.2.3 SUGGESTED MEMORY MODULES.....	3-22
4. AWARD BIOS SETUP .....	4-1
4.1 GETTING STARTED.....	4-1
4.2 MAIN MENU.....	4-3
4.3 CONTROL KEYS.....	4-4
4.4 STANDARD CMOS SETUP .....	4-5
4.5 BIOS FEATURES SETUP .....	4-6
4.6 CHIPSET FEATURES SETUP .....	4-11
4.7 POWER MANAGEMENT SETUP.....	4-14
4.8 PNP/PCI CONFIGURATION .....	4-19
4.9 INTEGRATED PERIPHERALS.....	4-22
4.10 LOAD SETUP DEFAULTS .....	4-25
4.11 SUPERVISOR PASSWORD / USER PASSWORD.....	4-26
4.12 IDE HDD AUTO DETECTION .....	4-26
4.13 HDD LOW LEVEL FORMAT .....	4-28
4.14 SAVE &EXIT SETUP .....	4-29
4.15 EXIT WITHOUT SAVING.....	4-30

### **TRADEMARKS**

All trademarks used in this manual are the property of their respective owners.

### **NOTE**

The “LOAD SETUP DEFAULTS” function loads the default settings directly from BIOS default table, these default settings are the best-case values that will optimize the system performance and increase the system stability. This strongly recommended when you first receive this system board, or the system CMOS data is corrupted.

Move the selection bar to “LOAD SETUP DEFAULTS” and then press the “ENTER” key and then the SETUP default values will be loaded into the system. (Please refers to the Chapter 4 AWARD BIOS SETUP procedures in this manual.)

### **NOTICE**

Information presented in this manual has been carefully checked for reliability; however, no responsibility is assumed for inaccuracies. The information contained in this manual is subject to change without prior notice.

## **1. INTRODUCTION**

### **1.1 SYSTEM OVERVIEW**

This mainboard is an AT form-factor PCI Local Bus Pentium system board with the updated AGP technology designed onboard. The most updated VIA MVP3 chipset for 100MHz Front Side Bus (FSB) is designed on the board.

This mainboard is designed for the high performance Pentium or other equivalent processors for high-end application and it is a true GREEN-PC computer system. The FSB clock speed can be adjusted to 100MHz when we are installing the processors with 100MHz FSB speed.

This system board supports the Peripheral Component Interconnect (PCI) Local Bus standard (PCI Specification Rev. 2.1 compliant). It not only breaks through the I/O bottlenecks of the traditional ISA mainboard, but also provides the ultra high performance for networking and multi-user environments.

The mainboard has built-in two channels PIO and Bus Master Enhanced PCI IDE port, one Floppy Disk control port, two high speed Serial ports (UARTs), one multi-mode Parallel port, one AT keyboard port, one PS/2 mouse port, one IR port, two USB ports.

The Accelerated Graphic Port (A.G.P.) on the board is designed for the updated AGP 3D video display card. Unlike the traditional PCI-based display cards, AGP technology provides lightening data throughput to fully facilitate the 3Diminsional and multimedia graphic display. The data transfer rate on the AGP port can be as fast as 133MHz and it is much faster than the traditional 33MHz PCI VGA cards.

The AGP is a new video display technology and it requires the device driver or new operating system to enable the accelerated graphic feature. Windows® 98 will supports AGP directly, but Windows® 95 still needs the appropriate device drivers to enable the AGP feature. Please don't worry about the device driver, you can always find the device driver included in the AGP card.

## 1.2 SYSTEM BOARD LAYOUT

The following picture displays the position of all connectors and jumpers. Please refer to the following sections for the detail description.

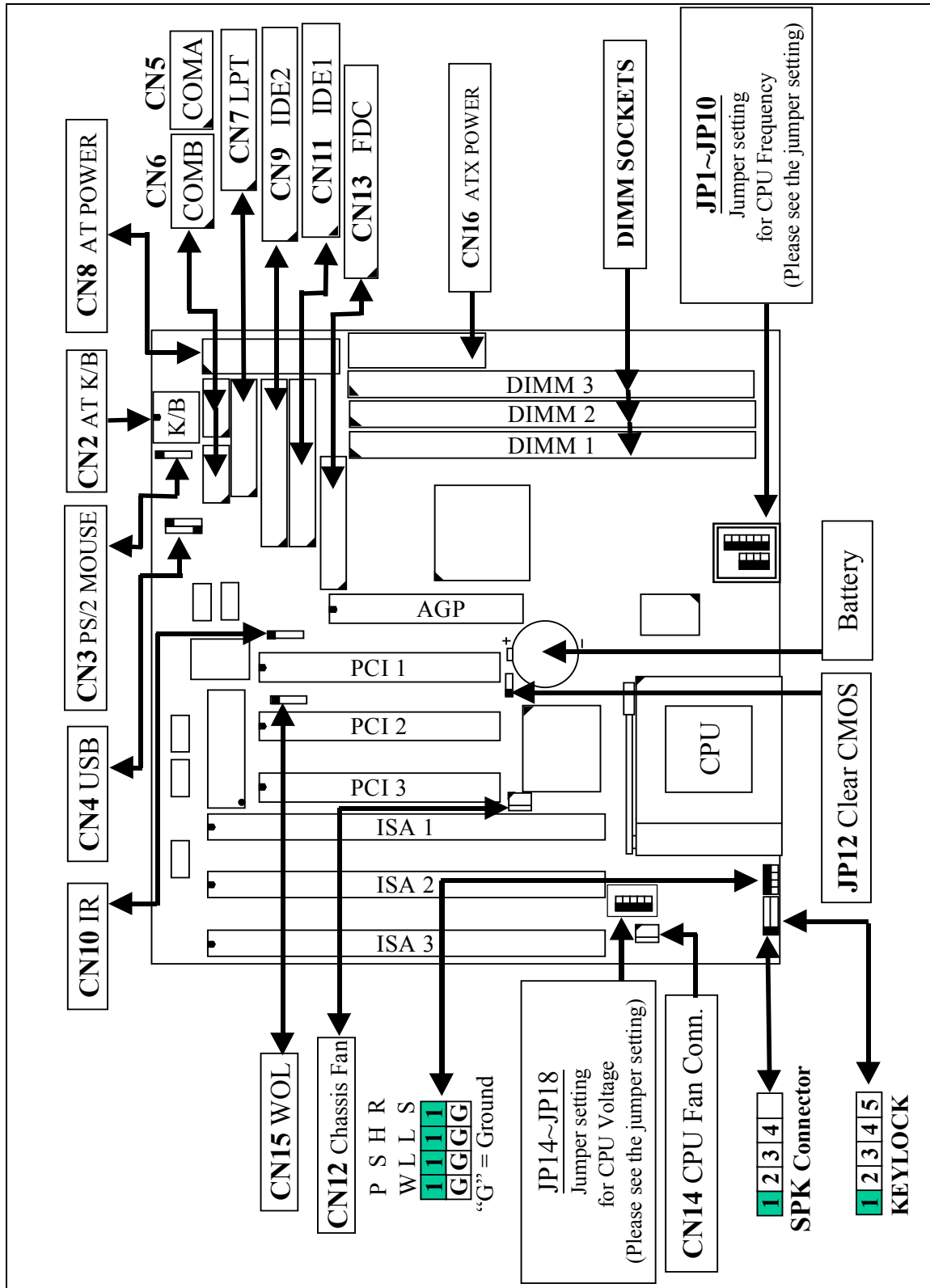

## 2. FEATURES

### 2.1 MAINBOARD SPECIFICATIONS

#### □ Chipset

VIA MVP3 (VT82C598MVP, VT82C586B) and Winbond W83877F / TF.

#### □ CPU

Intel : Pentium processor and OverDrive processor

90 / 100 / 120 / 133 / 150 / 166 / 200 / 233 MHz.

Cyrix : 6x86 / 6x86L - P150+ / P166+ / P200+.

6x86MX - PR166 / PR200 / PR233, 6x86MII - 266/300/333/366.

AMD : K5 - PR90 / PR100 / PR120 / PR133 / PR150 / PR166.

K6 / PR2-166 / 200 / 233 / 266 / 300

K6-2 / 266 / 300 / 333 / 350 / 366 / 380 / 400 / 450.

K6-3 / 400 / 450.

IDT : Win Chip C6-180 / 200 / 225 / 240.

Win Chip 2 - 200 / 233 / 266 / 300.

#### □ CPU Voltage

(1).CPU I/O voltage : “+3.3V DC” or ”+3.5V DC”.

(2).CPU CORE voltage: +1.3V DC ~ +3.5V DC.

#### □ System Clock

60 / 66 / 75 / 83 / 95 / 100 MHz

#### □ Memory

DRAM: Three banks, each bank can be single or double sided, 8MB up to 1GB.

Supports Extended Data Out (EDO), and SDRAM memory (Use 168-pin DIMM module x 3). Support +3.3V DC operating voltage on DIMM sockets.

SRAM : 512KB pipelined burst SRAM on board.

#### □ BIOS

AWARD System BIOS. 128KB x 8 Flash ROM (for Plug & Play BIOS).

**Expansion Slots**

AGP Slots: 32-bit x 1 (Supports 1x/2x AGP graphics cards)

PCI Slots : 32-bit x 3 (All Master / Slave, PCI 2.1 Compliant).

ISA Slots : 16-bit x 3 (PCI / ISA slot share one slot).

 **IDE Ports**

Two channel PIO and “Ultra DMA/33” Bus Master PCI IDE ports, which will connect maximum 4 IDE devices like IDE Hard Disk and ATAPI CD-ROM device.

PIO Mode 4 transfer rate up to 14 Mbytes/s transfer rates and supports “Ultra DMA/33” mode transfers up to 33 Mbytes/sec.

 **USB Ports**

Two Universal Serial Bus (USB) ports.

 **Super I/O Ports**

1. Two high speed NS16C550 compatible Serial ports (UARTs).

2. One SPP / EPP / ECP mode Bi-directional parallel port.

3. One Floppy Disk Control port.

 **WOL Port (Active only with ATX power supply)**

One WOL connector supports Wake-On-LAN (WOL up-designed)

 **IR Port**

One HPSIR and ASKIR compatible Infrared port. (FIR is optional )

 **Mouse and Keyboard**

Supports PS/2 Mouse connector, PS/2 Keyboard connector (optional) and AT Keyboard connector.

 **Software compatibility**

MS-DOS, Windows NT, OS/2, UNIX, NOVELL, MS Windows, CAD/CAM, Windows 98 , ...etc.

 **DIMENSION**

Width & Length : 220 mm x 220 mm.

Height : 3/4 inches with components mounted.

PCB Thickness : 4-layers, 0.05 inches normal.

Weight : 20 ounces.

**□ ENVIRONMENT**

Operating Temperature : 10°C to 40°C. (50°F to 104°F).

Require Airflow : 50 linear feet per minute across CPU.

Storage Temperature : -40°C to 70°C. (-40°F to 158°F).

Humidity : 0 to 90% non-condensing.

Altitude : 0 to 10,000 feet.

### 3. HARDWARE SETUP

This chapter explains how to configure the mainboard hardware. When you are installing the mainboard, you will have to make jumper settings and cable connections. Please refer to the following sections for the details:

#### 3.1 UNPACKING

The system board package contains the following parts :

- This system board.
- Operation manual.
- Cable set for IDE and I/O device.
- One CD diskette which includes device driver and utility program

The mainboard contains electric sensitive components which can be easily damaged by static electricity, please leave the mainboard sealed in its original packing until when installation.

Unpacking and installation shall be done on a grounded anti-static mat. The operator will have to wear an anti static wristband, grounded at the same point as the anti-static mat.

Inspect the mainboard carton to see whether there is any obvious damage. Shipping and handling may cause damage to your board. Be sure there is no shipping or handling damages on the board before proceeding.

After opening the motherboard color box, extract the mainboard and place it only on a grounded anti-static surface with the component side up. Inspect the board again to see whether there is any damage.

Press on all of the socket IC's to make sure that they are properly seated. Do this only with the board placed on a firm flat surface.

## 3.2 HARDWARE CONFIGURATION

Before the system board is ready for operating, the hardware must be configured to make sure it will work properly with different environment. To configure the system board is a simple task, only a few jumpers, connectors, cables and sockets needs to be selected and installed.

### 3.2.1 CONNECTORS

A connector is two or more pins that are used make connections to the system standard accessories (such as power, mouse, printer,...etc.). The following is a list of connectors on board, as well as descriptions of each individual connector.

#### (A) BAT1 Non-rechargeable battery (Using 3V Lithium battery : CR2032)

<u>Pin #</u>	<u>Assignment</u>
+	Battery Positive
-	Ground

#### (B) CN2 AT Keyboard connector

<u>Pin #</u>	<u>Assignment</u>	<u>Pin #</u>	<u>Assignment</u>
1	Keyboard Clock	2	Keyboard Data
3	No Connection	4	Ground
5	+5V DC		

#### (C) CN3 PS/2 Mouse connector

<u>Pin #</u>	<u>Assignment</u>
1	Mouse Data
2	No Connection
3	Ground
4	+5V DC
5	Mouse Clock

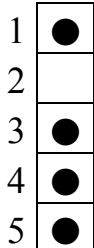

**(D) CN4** USB (Universal Serial Bus) connector

<b>(USB2)</b>		<u>Pin #</u>	5	1	<u>Pin #</u>	<b>(USB1)</b>	
Ground	(BLACK WIRE)	5	●	●	1	+5V DC	(RED WIRE)
Ground	(BLACK WIRE)	4	●	●	2	DATA-	(WHITE WIRE)
DATA+	(GREEN WIRE)	3	●	●	3	DATA+	(GREEN WIRE)
DATA-	(WHITE WIRE)	2	●	●	4	Ground	(BLACK WIRE)
+5V DC	(RED WIRE)	1	●	●	5	Ground	(BLACK WIRE)
			1	5			

**Caution:** Please make sure to use the right cable to connect USB device to the USB ports, wrong connector will destroy the mainboard.

**(E) CN5** COM A (Serial Port 1) connector

**(F) CN6** COM B (Serial Port 2) connector

<u>1</u>	<u>2</u>	<u>Pin #</u>	<u>Assignment</u>	<u>Pin #</u>	<u>Assignment</u>
●	●	1	DCD (Data Carrier Detect)	2	RD (Received Data)
●	●	3	TD (Transmit Data)	4	DTR (Data Terminal Ready)
●	●	5	Ground	6	DSR (Data Set Ready)
●	●	7	RTS (Request To Send)	8	CTS (Clear To Send)
●	●	9	RI (Ring Indicator)	10	No Connection
9	10				

**(G) CN7 Parallel Port Connector**

(Supports SPP/EPP/ECP mode, using IRQ7 or IRQ5, ECP modes use DMA channel 3 or channel 1, and it can be programmed by CMOS setup)

1	14	<u>Pin #</u>	<u>Assignment</u>	<u>Pin #</u>	<u>Assignment</u>
●	●	1	STROBE-	14	AUTO FEED-
●	●	2	Data Bit 0	15	ERROR-
●	●	3	Data Bit 1	16	INIT-
●	●	4	Data Bit 2	17	SLCT IN-
●	●	5	Data Bit 3	18	Ground
●	●	6	Data Bit 4	19	Ground
●	●	7	Data Bit 5	20	Ground
●	●	8	Data Bit 6	21	Ground
●	●	9	Data Bit 7	22	Ground
●	●	10	ACK-	23	Ground
●	●	11	BUSY	24	Ground
●	●	12	PE	25	Ground
●	●	13	SLCT	26	No Connection

**(H) CN8 AT Power connector**

	<u>Pin #</u>	<u>Assignment</u>	
	1	Power Good	<b>(Orange)</b>
	2	+5V DC	<b>(Red)</b>
	3	+12V DC	<b>(Yellow)</b>
	4	-12V DC	<b>(Blue)</b>
	5	Ground	<b>(Black)</b>
	6	Ground	<b>(Black)</b>
	7	Ground	<b>(Black)</b>
	8	Ground	<b>(Black)</b>
	9	-5V DC	<b>(White)</b>
	10	+5V DC	<b>(Red)</b>
	11	+5V DC	<b>(Red)</b>
	12	+5V DC	<b>(Red)</b>

**(I) CN9** IDE 2 connector (Secondary IDE Port, using IRQ15)

**(J) CN10** IR (Infrared Rays) transmission connector

	<u>Pin #</u>	<u>Assignment</u>
●	1	+5V DC
	2	No Connection
●	3	IR Receive
●	4	Ground
●	5	IR Transmit

**(K) CN11** IDE 1 connector (Primary IDE Port, using IRQ14)

**(L) CN12** Chassis Fan connector

	<u>Pin #</u>	<u>Assignment</u>
●	1	Ground
●	2	+12V DC
●	3	Fan Sense Signal

**(M) CN13** Floppy Disk Control Port connector (Using IRQ6, DMA channel 2)

**(N) CN14** CPU Cooling Fan Power connector (optional)

	<u>Pin #</u>	<u>Assignment</u>
●	1	Ground
●	2	+12V DC
●	3	Fan Sense Signal

**(O) CN15** Wake On Lan connector (WOL)

	<u>Pin #</u>	<u>Assignment</u>
●	1	+5V Standby voltage
●	2	Ground
●	3	WOL Signal

**(P) KBLOCK** Front Panel Power LED & Key-Lock connector

1	<u>Pin #</u>	<u>Assignment</u>
●	1	Pullup (+5V DC for Power LED)
●	2	No Connection
●	3	Ground
●	4	Keyboard Lock
●	5	Ground

**(Q) SPK** Speaker connector

1	<u>Pin #</u>	<u>Assignment</u>
●	1	+5V DC
●	2	No Connection
●	3	No Connection
●	4	Speaker Data Signal

**(R) RS** Reset Button connector

Open : No action

Short : System Reset

Pin # AssignmentPin # Assignment

1 Reset Control

2 Ground

**(S) HL** IDE HDD LED connectorPin # AssignmentPin # Assignment

1 Pullup (+5V DC)

2 Signal Pin

**(T) SL** Sleep LED connectorPin # Assignment

1 Sleep Signal

2 Ground

**(U) PW. Power Switch Connector**

The PW connector shall be connected to the front panel PW button of your PC system. When different type of switching power supplier is connected to the mainboard, the PW button will have different functions:

1. When this mainboard has the ATX power supply connected, the PW connector has two different functions according to the setup in CMOS. It can be the Power Switch or Suspend Switch of your PC system. (please refer to Section-4-7 for BIOS setup)

① **If the setup in CMOS is “Delay 4 Sec.”, the switch function will be:**

**a). When system is power off :**

Click on this switch, the system will be powered on.

**b). When system power is on :**

a. The system is in Full-ON mode :

- a-1. Click on the PW switch ( less than 4 seconds ), the system will be turned into Suspend mode. (turn into the GREEN mode)
- a-2. Press and hold this switch for more than 4 seconds, the system will be powered off immediately.

b. When the system is in Suspend mode :

- b-1. Click on this switch ( less than 4 seconds ), the system will return to Full-ON mode.
- b-2. Press and hold this switch more than 4 seconds, the system will be powered off.

② **The setup in CMOS is “Instant-off”:**

a). When system power is off :

Click on this switch, the system will be powered on.

b). When system power is on :

Click on this switch, the system will be powered off instantly.

2. When this mainboard has the AT power supply connected, the PW connector will be used to turn the PC system into "Green Mode" and have the PC system waked up from the "Green Mode".

a). When the system is in the full-on mode, a click on the PW button will trun the PC system into "Green Mode".

b). When the PC system is in the "Green Mode", a click on the PW button will wake the PC system up to full-on mode

3.2.2 JUMPERS

This section will discuss the jumper setting on this mainboard. A jumper is a set of two, three or more jumper pins which allows you to make different system configuration by putting the plastic connector plug (mini-jumper) on it. The jumper setting is necessary when installing different components onto the mainboard. **Please make sure all jumper settings are correct before you can start the installation.**

In order to let you have better idea of the jumper setting, please see below for the explanation of jumper settings before you start this section.

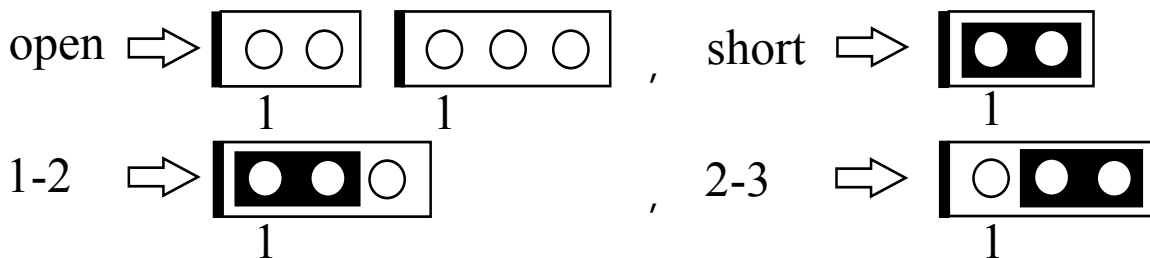

(A) JP1~ JP6, JP9, JP10 & JP14~JP18: CPU type selection

These jumpers are designed to select voltage and frequency for different CPUs, please refer to the following tables for details

CPU TYPE	JP1~6, JP9~10	JP14~JP18	CPU TYPE	JP1~6, JP9~10	JP14~JP18
	60MHz x 1.5	V <sub>CORE</sub> = 3.5V		66MHz x 1.5	V <sub>CORE</sub> = 3.5V
AMD	1 2	1 2	AMD	1 2	1 2
K5-PR90	<input checked="" type="checkbox"/> <input checked="" type="checkbox"/> JP1	<input checked="" type="checkbox"/> <input checked="" type="checkbox"/> JP14	K5-PR100	<input type="checkbox"/> <input type="checkbox"/> JP1	<input checked="" type="checkbox"/> <input checked="" type="checkbox"/> JP14
K5-PR120	<input checked="" type="checkbox"/> <input checked="" type="checkbox"/> JP2	<input checked="" type="checkbox"/> <input checked="" type="checkbox"/> JP15	K5-PR133	<input checked="" type="checkbox"/> <input checked="" type="checkbox"/> JP2	<input checked="" type="checkbox"/> <input checked="" type="checkbox"/> JP15
	<input checked="" type="checkbox"/> <input checked="" type="checkbox"/> JP3	<input checked="" type="checkbox"/> <input checked="" type="checkbox"/> JP16		<input checked="" type="checkbox"/> <input checked="" type="checkbox"/> JP3	<input checked="" type="checkbox"/> <input checked="" type="checkbox"/> JP16
	<input type="checkbox"/> <input type="checkbox"/> JP4	<input checked="" type="checkbox"/> <input checked="" type="checkbox"/> JP17		<input type="checkbox"/> <input type="checkbox"/> JP4	<input checked="" type="checkbox"/> <input checked="" type="checkbox"/> JP17
	<input type="checkbox"/> <input type="checkbox"/> JP5	<input type="checkbox"/> <input type="checkbox"/> JP18		<input type="checkbox"/> <input type="checkbox"/> JP5	<input type="checkbox"/> <input type="checkbox"/> JP18
	<input type="checkbox"/> <input type="checkbox"/> JP6			<input type="checkbox"/> <input type="checkbox"/> JP6	
	<input checked="" type="checkbox"/> <input checked="" type="checkbox"/> JP9			<input checked="" type="checkbox"/> <input checked="" type="checkbox"/> JP9	
	<input checked="" type="checkbox"/> <input checked="" type="checkbox"/> JP10			<input checked="" type="checkbox"/> <input checked="" type="checkbox"/> JP10	

CPU TYPE	JP1~6, JP9~10	JP14~JP18	CPU TYPE	JP1~6, JP9~10	JP14~JP18
----------	---------------	-----------	----------	---------------	-----------

**MVP3 SYSTEM BOARD**

**HARDWARE SETUP**

AMD K5-PR150	60MHz x 2.5	V <sub>CORE</sub> = 3.5V	AMD K5-PR166	66MHz x 2.5	V <sub>CORE</sub> = 3.5V
	1 2	1 2		1 2	1 2
	<input checked="" type="checkbox"/> <input checked="" type="checkbox"/> JP1	<input checked="" type="checkbox"/> <input checked="" type="checkbox"/> JP14		<input type="checkbox"/> <input type="checkbox"/> JP1	<input checked="" type="checkbox"/> <input checked="" type="checkbox"/> JP14
	<input checked="" type="checkbox"/> <input checked="" type="checkbox"/> JP2	<input checked="" type="checkbox"/> <input checked="" type="checkbox"/> JP15		<input checked="" type="checkbox"/> <input checked="" type="checkbox"/> JP2	<input checked="" type="checkbox"/> <input checked="" type="checkbox"/> JP15
	<input checked="" type="checkbox"/> <input checked="" type="checkbox"/> JP3	<input checked="" type="checkbox"/> <input checked="" type="checkbox"/> JP16		<input checked="" type="checkbox"/> <input checked="" type="checkbox"/> JP3	<input checked="" type="checkbox"/> <input checked="" type="checkbox"/> JP16
	<input checked="" type="checkbox"/> <input checked="" type="checkbox"/> JP4	<input checked="" type="checkbox"/> <input checked="" type="checkbox"/> JP17		<input checked="" type="checkbox"/> <input checked="" type="checkbox"/> JP4	<input checked="" type="checkbox"/> <input checked="" type="checkbox"/> JP17
	<input checked="" type="checkbox"/> <input checked="" type="checkbox"/> JP5	<input type="checkbox"/> <input type="checkbox"/> JP18		<input checked="" type="checkbox"/> <input checked="" type="checkbox"/> JP5	<input type="checkbox"/> <input type="checkbox"/> JP18
	<input type="checkbox"/> <input type="checkbox"/> JP6			<input type="checkbox"/> <input type="checkbox"/> JP6	
	<input checked="" type="checkbox"/> <input checked="" type="checkbox"/> JP9			<input checked="" type="checkbox"/> <input checked="" type="checkbox"/> JP9	
	<input checked="" type="checkbox"/> <input checked="" type="checkbox"/> JP10			<input checked="" type="checkbox"/> <input checked="" type="checkbox"/> JP10	

CPU TYPE	JP1~6, JP9~10	JP14~JP18	CPU TYPE	JP1~6, JP9~10	JP14~JP18
AMD K6 / PR2 -166	66MHz x 2.5	V <sub>CORE</sub> = 2.9V	AMD K6 / PR2 -200	66MHz x 3	V <sub>CORE</sub> = 2.9V
	1 2	1 2		1 2	1 2
	<input type="checkbox"/> <input type="checkbox"/> JP1	<input checked="" type="checkbox"/> <input checked="" type="checkbox"/> JP14		<input type="checkbox"/> <input type="checkbox"/> JP1	<input checked="" type="checkbox"/> <input checked="" type="checkbox"/> JP14
	<input checked="" type="checkbox"/> <input checked="" type="checkbox"/> JP2	<input type="checkbox"/> <input type="checkbox"/> JP15		<input checked="" type="checkbox"/> <input checked="" type="checkbox"/> JP2	<input type="checkbox"/> <input type="checkbox"/> JP15
	<input checked="" type="checkbox"/> <input checked="" type="checkbox"/> JP3	<input type="checkbox"/> <input type="checkbox"/> JP16		<input checked="" type="checkbox"/> <input checked="" type="checkbox"/> JP3	<input type="checkbox"/> <input type="checkbox"/> JP16
	<input checked="" type="checkbox"/> <input checked="" type="checkbox"/> JP4	<input checked="" type="checkbox"/> <input checked="" type="checkbox"/> JP17		<input type="checkbox"/> <input type="checkbox"/> JP4	<input checked="" type="checkbox"/> <input checked="" type="checkbox"/> JP17
	<input checked="" type="checkbox"/> <input checked="" type="checkbox"/> JP5	<input type="checkbox"/> <input type="checkbox"/> JP18		<input checked="" type="checkbox"/> <input checked="" type="checkbox"/> JP5	<input type="checkbox"/> <input type="checkbox"/> JP18
	<input type="checkbox"/> <input type="checkbox"/> JP6			<input type="checkbox"/> <input type="checkbox"/> JP6	
	<input checked="" type="checkbox"/> <input checked="" type="checkbox"/> JP9			<input checked="" type="checkbox"/> <input checked="" type="checkbox"/> JP9	
	<input checked="" type="checkbox"/> <input checked="" type="checkbox"/> JP10			<input checked="" type="checkbox"/> <input checked="" type="checkbox"/> JP10	

CPU TYPE	JP1~6, JP9~10	JP14~JP18	CPU TYPE	JP1~6, JP9~10	JP14~JP18
AMD K6-233	66MHz x 3.5	V <sub>CORE</sub> = 3.2V	AMD K6 / 266 K6-2 / 266	66MHz x 4	V <sub>CORE</sub> = 2.2V
	1 2	1 2		1 2	1 2
	<input type="checkbox"/> <input type="checkbox"/> JP1	<input type="checkbox"/> <input type="checkbox"/> JP14		<input type="checkbox"/> <input type="checkbox"/> JP1	<input type="checkbox"/> <input type="checkbox"/> JP14
	<input checked="" type="checkbox"/> <input checked="" type="checkbox"/> JP2	<input type="checkbox"/> <input type="checkbox"/> JP15		<input checked="" type="checkbox"/> <input checked="" type="checkbox"/> JP2	<input checked="" type="checkbox"/> <input checked="" type="checkbox"/> JP15
	<input checked="" type="checkbox"/> <input checked="" type="checkbox"/> JP3	<input checked="" type="checkbox"/> <input checked="" type="checkbox"/> JP16		<input checked="" type="checkbox"/> <input checked="" type="checkbox"/> JP3	<input type="checkbox"/> <input type="checkbox"/> JP16
	<input type="checkbox"/> <input type="checkbox"/> JP4	<input checked="" type="checkbox"/> <input checked="" type="checkbox"/> JP17		<input checked="" type="checkbox"/> <input checked="" type="checkbox"/> JP4	<input type="checkbox"/> <input type="checkbox"/> JP17
	<input type="checkbox"/> <input type="checkbox"/> JP5	<input type="checkbox"/> <input type="checkbox"/> JP18		<input type="checkbox"/> <input type="checkbox"/> JP5	<input type="checkbox"/> <input type="checkbox"/> JP18
	<input type="checkbox"/> <input type="checkbox"/> JP6			<input checked="" type="checkbox"/> <input checked="" type="checkbox"/> JP6	
	<input checked="" type="checkbox"/> <input checked="" type="checkbox"/> JP9			<input checked="" type="checkbox"/> <input checked="" type="checkbox"/> JP9	
	<input checked="" type="checkbox"/> <input checked="" type="checkbox"/> JP10			<input checked="" type="checkbox"/> <input checked="" type="checkbox"/> JP10	

CPU TYPE	JP1~6, JP9~10	JP14~JP18	CPU TYPE	JP1~6, JP9~10	JP14~JP18
----------	---------------	-----------	----------	---------------	-----------

AMD K6 / 300	66MHz x 4.5	V <sub>CORE</sub> = 2.2V	AMD K6-2/300	100MHz x 3	V <sub>CORE</sub> = 2.2V																																																																																								
	<table border="0"> <tr><td>1</td><td>2</td><td></td></tr> <tr><td><input type="checkbox"/></td><td><input type="checkbox"/></td><td>JP1</td></tr> <tr><td><input checked="" type="checkbox"/></td><td><input checked="" type="checkbox"/></td><td>JP2</td></tr> <tr><td><input checked="" type="checkbox"/></td><td><input checked="" type="checkbox"/></td><td>JP3</td></tr> <tr><td><input checked="" type="checkbox"/></td><td><input checked="" type="checkbox"/></td><td>JP4</td></tr> <tr><td><input checked="" type="checkbox"/></td><td><input checked="" type="checkbox"/></td><td>JP5</td></tr> <tr><td><input checked="" type="checkbox"/></td><td><input checked="" type="checkbox"/></td><td>JP6</td></tr> <tr><td><input checked="" type="checkbox"/></td><td><input checked="" type="checkbox"/></td><td>JP9</td></tr> <tr><td><input checked="" type="checkbox"/></td><td><input checked="" type="checkbox"/></td><td>JP10</td></tr> </table>	1		2		<input type="checkbox"/>	<input type="checkbox"/>	JP1	<input checked="" type="checkbox"/>	<input checked="" type="checkbox"/>	JP2	<input checked="" type="checkbox"/>	<input checked="" type="checkbox"/>	JP3	<input checked="" type="checkbox"/>	<input checked="" type="checkbox"/>	JP4	<input checked="" type="checkbox"/>	<input checked="" type="checkbox"/>	JP5	<input checked="" type="checkbox"/>	<input checked="" type="checkbox"/>	JP6	<input checked="" type="checkbox"/>	<input checked="" type="checkbox"/>	JP9	<input checked="" type="checkbox"/>	<input checked="" type="checkbox"/>	JP10	<table border="0"> <tr><td>1</td><td>2</td><td></td></tr> <tr><td><input type="checkbox"/></td><td><input type="checkbox"/></td><td>JP14</td></tr> <tr><td><input checked="" type="checkbox"/></td><td><input checked="" type="checkbox"/></td><td>JP15</td></tr> <tr><td><input type="checkbox"/></td><td><input type="checkbox"/></td><td>JP16</td></tr> <tr><td><input type="checkbox"/></td><td><input type="checkbox"/></td><td>JP17</td></tr> <tr><td><input type="checkbox"/></td><td><input type="checkbox"/></td><td>JP18</td></tr> </table>	1	2		<input type="checkbox"/>	<input type="checkbox"/>	JP14	<input checked="" type="checkbox"/>	<input checked="" type="checkbox"/>	JP15	<input type="checkbox"/>	<input type="checkbox"/>	JP16	<input type="checkbox"/>	<input type="checkbox"/>	JP17	<input type="checkbox"/>	<input type="checkbox"/>	JP18	<table border="0"> <tr><td>1</td><td>2</td><td></td></tr> <tr><td><input type="checkbox"/></td><td><input type="checkbox"/></td><td>JP1</td></tr> <tr><td><input type="checkbox"/></td><td><input type="checkbox"/></td><td>JP2</td></tr> <tr><td><input type="checkbox"/></td><td><input type="checkbox"/></td><td>JP3</td></tr> <tr><td><input type="checkbox"/></td><td><input type="checkbox"/></td><td>JP4</td></tr> <tr><td><input checked="" type="checkbox"/></td><td><input checked="" type="checkbox"/></td><td>JP5</td></tr> <tr><td><input type="checkbox"/></td><td><input type="checkbox"/></td><td>JP6</td></tr> <tr><td><input type="checkbox"/></td><td><input type="checkbox"/></td><td>JP9</td></tr> <tr><td><input checked="" type="checkbox"/></td><td><input checked="" type="checkbox"/></td><td>JP10</td></tr> </table>	1	2		<input type="checkbox"/>	<input type="checkbox"/>	JP1	<input type="checkbox"/>	<input type="checkbox"/>	JP2	<input type="checkbox"/>	<input type="checkbox"/>	JP3	<input type="checkbox"/>	<input type="checkbox"/>	JP4	<input checked="" type="checkbox"/>	<input checked="" type="checkbox"/>	JP5	<input type="checkbox"/>	<input type="checkbox"/>	JP6	<input type="checkbox"/>	<input type="checkbox"/>	JP9	<input checked="" type="checkbox"/>	<input checked="" type="checkbox"/>	JP10	<table border="0"> <tr><td>1</td><td>2</td><td></td></tr> <tr><td><input type="checkbox"/></td><td><input type="checkbox"/></td><td>JP14</td></tr> <tr><td><input checked="" type="checkbox"/></td><td><input checked="" type="checkbox"/></td><td>JP15</td></tr> <tr><td><input type="checkbox"/></td><td><input type="checkbox"/></td><td>JP16</td></tr> <tr><td><input type="checkbox"/></td><td><input type="checkbox"/></td><td>JP17</td></tr> <tr><td><input type="checkbox"/></td><td><input type="checkbox"/></td><td>JP18</td></tr> </table>	1	2		<input type="checkbox"/>	<input type="checkbox"/>	JP14	<input checked="" type="checkbox"/>	<input checked="" type="checkbox"/>	JP15	<input type="checkbox"/>	<input type="checkbox"/>	JP16	<input type="checkbox"/>	<input type="checkbox"/>	JP17	<input type="checkbox"/>
1	2																																																																																												
<input type="checkbox"/>	<input type="checkbox"/>	JP1																																																																																											
<input checked="" type="checkbox"/>	<input checked="" type="checkbox"/>	JP2																																																																																											
<input checked="" type="checkbox"/>	<input checked="" type="checkbox"/>	JP3																																																																																											
<input checked="" type="checkbox"/>	<input checked="" type="checkbox"/>	JP4																																																																																											
<input checked="" type="checkbox"/>	<input checked="" type="checkbox"/>	JP5																																																																																											
<input checked="" type="checkbox"/>	<input checked="" type="checkbox"/>	JP6																																																																																											
<input checked="" type="checkbox"/>	<input checked="" type="checkbox"/>	JP9																																																																																											
<input checked="" type="checkbox"/>	<input checked="" type="checkbox"/>	JP10																																																																																											
1	2																																																																																												
<input type="checkbox"/>	<input type="checkbox"/>	JP14																																																																																											
<input checked="" type="checkbox"/>	<input checked="" type="checkbox"/>	JP15																																																																																											
<input type="checkbox"/>	<input type="checkbox"/>	JP16																																																																																											
<input type="checkbox"/>	<input type="checkbox"/>	JP17																																																																																											
<input type="checkbox"/>	<input type="checkbox"/>	JP18																																																																																											
1	2																																																																																												
<input type="checkbox"/>	<input type="checkbox"/>	JP1																																																																																											
<input type="checkbox"/>	<input type="checkbox"/>	JP2																																																																																											
<input type="checkbox"/>	<input type="checkbox"/>	JP3																																																																																											
<input type="checkbox"/>	<input type="checkbox"/>	JP4																																																																																											
<input checked="" type="checkbox"/>	<input checked="" type="checkbox"/>	JP5																																																																																											
<input type="checkbox"/>	<input type="checkbox"/>	JP6																																																																																											
<input type="checkbox"/>	<input type="checkbox"/>	JP9																																																																																											
<input checked="" type="checkbox"/>	<input checked="" type="checkbox"/>	JP10																																																																																											
1	2																																																																																												
<input type="checkbox"/>	<input type="checkbox"/>	JP14																																																																																											
<input checked="" type="checkbox"/>	<input checked="" type="checkbox"/>	JP15																																																																																											
<input type="checkbox"/>	<input type="checkbox"/>	JP16																																																																																											
<input type="checkbox"/>	<input type="checkbox"/>	JP17																																																																																											
<input type="checkbox"/>	<input type="checkbox"/>	JP18																																																																																											

CPU TYPE	JP1~6, JP9~10	JP14~JP18	CPU TYPE	JP1~6, JP9~10	JP14~JP18																																																																																								
AMD K6-2 / 333	95MHz x 3.5	V <sub>CORE</sub> = 2.2V	AMD K6-2/350	100MHz x 3.5	V <sub>CORE</sub> = 2.2V																																																																																								
	<table border="0"> <tr><td>1</td><td>2</td><td></td></tr> <tr><td><input checked="" type="checkbox"/></td><td><input checked="" type="checkbox"/></td><td>JP1</td></tr> <tr><td><input type="checkbox"/></td><td><input type="checkbox"/></td><td>JP2</td></tr> <tr><td><input type="checkbox"/></td><td><input type="checkbox"/></td><td>JP3</td></tr> <tr><td><input type="checkbox"/></td><td><input type="checkbox"/></td><td>JP4</td></tr> <tr><td><input type="checkbox"/></td><td><input type="checkbox"/></td><td>JP5</td></tr> <tr><td><input type="checkbox"/></td><td><input type="checkbox"/></td><td>JP6</td></tr> <tr><td><input type="checkbox"/></td><td><input type="checkbox"/></td><td>JP9</td></tr> <tr><td><input checked="" type="checkbox"/></td><td><input checked="" type="checkbox"/></td><td>JP10</td></tr> </table>	1		2		<input checked="" type="checkbox"/>	<input checked="" type="checkbox"/>	JP1	<input type="checkbox"/>	<input type="checkbox"/>	JP2	<input type="checkbox"/>	<input type="checkbox"/>	JP3	<input type="checkbox"/>	<input type="checkbox"/>	JP4	<input type="checkbox"/>	<input type="checkbox"/>	JP5	<input type="checkbox"/>	<input type="checkbox"/>	JP6	<input type="checkbox"/>	<input type="checkbox"/>	JP9	<input checked="" type="checkbox"/>	<input checked="" type="checkbox"/>	JP10	<table border="0"> <tr><td>1</td><td>2</td><td></td></tr> <tr><td><input type="checkbox"/></td><td><input type="checkbox"/></td><td>JP14</td></tr> <tr><td><input checked="" type="checkbox"/></td><td><input checked="" type="checkbox"/></td><td>JP15</td></tr> <tr><td><input type="checkbox"/></td><td><input type="checkbox"/></td><td>JP16</td></tr> <tr><td><input type="checkbox"/></td><td><input type="checkbox"/></td><td>JP17</td></tr> <tr><td><input type="checkbox"/></td><td><input type="checkbox"/></td><td>JP18</td></tr> </table>	1	2		<input type="checkbox"/>	<input type="checkbox"/>	JP14	<input checked="" type="checkbox"/>	<input checked="" type="checkbox"/>	JP15	<input type="checkbox"/>	<input type="checkbox"/>	JP16	<input type="checkbox"/>	<input type="checkbox"/>	JP17	<input type="checkbox"/>	<input type="checkbox"/>	JP18	<table border="0"> <tr><td>1</td><td>2</td><td></td></tr> <tr><td><input type="checkbox"/></td><td><input type="checkbox"/></td><td>JP1</td></tr> <tr><td><input type="checkbox"/></td><td><input type="checkbox"/></td><td>JP2</td></tr> <tr><td><input type="checkbox"/></td><td><input type="checkbox"/></td><td>JP3</td></tr> <tr><td><input type="checkbox"/></td><td><input type="checkbox"/></td><td>JP4</td></tr> <tr><td><input type="checkbox"/></td><td><input type="checkbox"/></td><td>JP5</td></tr> <tr><td><input type="checkbox"/></td><td><input type="checkbox"/></td><td>JP6</td></tr> <tr><td><input type="checkbox"/></td><td><input type="checkbox"/></td><td>JP9</td></tr> <tr><td><input checked="" type="checkbox"/></td><td><input checked="" type="checkbox"/></td><td>JP10</td></tr> </table>	1	2		<input type="checkbox"/>	<input type="checkbox"/>	JP1	<input type="checkbox"/>	<input type="checkbox"/>	JP2	<input type="checkbox"/>	<input type="checkbox"/>	JP3	<input type="checkbox"/>	<input type="checkbox"/>	JP4	<input type="checkbox"/>	<input type="checkbox"/>	JP5	<input type="checkbox"/>	<input type="checkbox"/>	JP6	<input type="checkbox"/>	<input type="checkbox"/>	JP9	<input checked="" type="checkbox"/>	<input checked="" type="checkbox"/>	JP10	<table border="0"> <tr><td>1</td><td>2</td><td></td></tr> <tr><td><input type="checkbox"/></td><td><input type="checkbox"/></td><td>JP14</td></tr> <tr><td><input checked="" type="checkbox"/></td><td><input checked="" type="checkbox"/></td><td>JP15</td></tr> <tr><td><input type="checkbox"/></td><td><input type="checkbox"/></td><td>JP16</td></tr> <tr><td><input type="checkbox"/></td><td><input type="checkbox"/></td><td>JP17</td></tr> <tr><td><input type="checkbox"/></td><td><input type="checkbox"/></td><td>JP18</td></tr> </table>	1	2		<input type="checkbox"/>	<input type="checkbox"/>	JP14	<input checked="" type="checkbox"/>	<input checked="" type="checkbox"/>	JP15	<input type="checkbox"/>	<input type="checkbox"/>	JP16	<input type="checkbox"/>	<input type="checkbox"/>	JP17	<input type="checkbox"/>
1	2																																																																																												
<input checked="" type="checkbox"/>	<input checked="" type="checkbox"/>	JP1																																																																																											
<input type="checkbox"/>	<input type="checkbox"/>	JP2																																																																																											
<input type="checkbox"/>	<input type="checkbox"/>	JP3																																																																																											
<input type="checkbox"/>	<input type="checkbox"/>	JP4																																																																																											
<input type="checkbox"/>	<input type="checkbox"/>	JP5																																																																																											
<input type="checkbox"/>	<input type="checkbox"/>	JP6																																																																																											
<input type="checkbox"/>	<input type="checkbox"/>	JP9																																																																																											
<input checked="" type="checkbox"/>	<input checked="" type="checkbox"/>	JP10																																																																																											
1	2																																																																																												
<input type="checkbox"/>	<input type="checkbox"/>	JP14																																																																																											
<input checked="" type="checkbox"/>	<input checked="" type="checkbox"/>	JP15																																																																																											
<input type="checkbox"/>	<input type="checkbox"/>	JP16																																																																																											
<input type="checkbox"/>	<input type="checkbox"/>	JP17																																																																																											
<input type="checkbox"/>	<input type="checkbox"/>	JP18																																																																																											
1	2																																																																																												
<input type="checkbox"/>	<input type="checkbox"/>	JP1																																																																																											
<input type="checkbox"/>	<input type="checkbox"/>	JP2																																																																																											
<input type="checkbox"/>	<input type="checkbox"/>	JP3																																																																																											
<input type="checkbox"/>	<input type="checkbox"/>	JP4																																																																																											
<input type="checkbox"/>	<input type="checkbox"/>	JP5																																																																																											
<input type="checkbox"/>	<input type="checkbox"/>	JP6																																																																																											
<input type="checkbox"/>	<input type="checkbox"/>	JP9																																																																																											
<input checked="" type="checkbox"/>	<input checked="" type="checkbox"/>	JP10																																																																																											
1	2																																																																																												
<input type="checkbox"/>	<input type="checkbox"/>	JP14																																																																																											
<input checked="" type="checkbox"/>	<input checked="" type="checkbox"/>	JP15																																																																																											
<input type="checkbox"/>	<input type="checkbox"/>	JP16																																																																																											
<input type="checkbox"/>	<input type="checkbox"/>	JP17																																																																																											
<input type="checkbox"/>	<input type="checkbox"/>	JP18																																																																																											

CPU TYPE	JP1~6, JP9~10	JP14~JP18	CPU TYPE	JP1~6, JP9~10	JP14~JP18																																																																																								
AMD K6-2 / 366	66MHz x 5.5	V <sub>CORE</sub> = 2.2V	AMD K6-2 / 380	95MHz x 4	V <sub>CORE</sub> = 2.2V																																																																																								
	<table border="0"> <tr><td>1</td><td>2</td><td></td></tr> <tr><td><input type="checkbox"/></td><td><input type="checkbox"/></td><td>JP1</td></tr> <tr><td><input checked="" type="checkbox"/></td><td><input checked="" type="checkbox"/></td><td>JP2</td></tr> <tr><td><input checked="" type="checkbox"/></td><td><input checked="" type="checkbox"/></td><td>JP3</td></tr> <tr><td><input type="checkbox"/></td><td><input type="checkbox"/></td><td>JP4</td></tr> <tr><td><input type="checkbox"/></td><td><input type="checkbox"/></td><td>JP5</td></tr> <tr><td><input checked="" type="checkbox"/></td><td><input checked="" type="checkbox"/></td><td>JP6</td></tr> <tr><td><input checked="" type="checkbox"/></td><td><input checked="" type="checkbox"/></td><td>JP9</td></tr> <tr><td><input checked="" type="checkbox"/></td><td><input checked="" type="checkbox"/></td><td>JP10</td></tr> </table>	1		2		<input type="checkbox"/>	<input type="checkbox"/>	JP1	<input checked="" type="checkbox"/>	<input checked="" type="checkbox"/>	JP2	<input checked="" type="checkbox"/>	<input checked="" type="checkbox"/>	JP3	<input type="checkbox"/>	<input type="checkbox"/>	JP4	<input type="checkbox"/>	<input type="checkbox"/>	JP5	<input checked="" type="checkbox"/>	<input checked="" type="checkbox"/>	JP6	<input checked="" type="checkbox"/>	<input checked="" type="checkbox"/>	JP9	<input checked="" type="checkbox"/>	<input checked="" type="checkbox"/>	JP10	<table border="0"> <tr><td>1</td><td>2</td><td></td></tr> <tr><td><input type="checkbox"/></td><td><input type="checkbox"/></td><td>JP14</td></tr> <tr><td><input checked="" type="checkbox"/></td><td><input checked="" type="checkbox"/></td><td>JP15</td></tr> <tr><td><input type="checkbox"/></td><td><input type="checkbox"/></td><td>JP16</td></tr> <tr><td><input type="checkbox"/></td><td><input type="checkbox"/></td><td>JP17</td></tr> <tr><td><input type="checkbox"/></td><td><input type="checkbox"/></td><td>JP18</td></tr> </table>	1	2		<input type="checkbox"/>	<input type="checkbox"/>	JP14	<input checked="" type="checkbox"/>	<input checked="" type="checkbox"/>	JP15	<input type="checkbox"/>	<input type="checkbox"/>	JP16	<input type="checkbox"/>	<input type="checkbox"/>	JP17	<input type="checkbox"/>	<input type="checkbox"/>	JP18	<table border="0"> <tr><td>1</td><td>2</td><td></td></tr> <tr><td><input checked="" type="checkbox"/></td><td><input checked="" type="checkbox"/></td><td>JP1</td></tr> <tr><td><input type="checkbox"/></td><td><input type="checkbox"/></td><td>JP2</td></tr> <tr><td><input type="checkbox"/></td><td><input type="checkbox"/></td><td>JP3</td></tr> <tr><td><input checked="" type="checkbox"/></td><td><input checked="" type="checkbox"/></td><td>JP4</td></tr> <tr><td><input type="checkbox"/></td><td><input type="checkbox"/></td><td>JP5</td></tr> <tr><td><input checked="" type="checkbox"/></td><td><input checked="" type="checkbox"/></td><td>JP6</td></tr> <tr><td><input type="checkbox"/></td><td><input type="checkbox"/></td><td>JP9</td></tr> <tr><td><input checked="" type="checkbox"/></td><td><input checked="" type="checkbox"/></td><td>JP10</td></tr> </table>	1	2		<input checked="" type="checkbox"/>	<input checked="" type="checkbox"/>	JP1	<input type="checkbox"/>	<input type="checkbox"/>	JP2	<input type="checkbox"/>	<input type="checkbox"/>	JP3	<input checked="" type="checkbox"/>	<input checked="" type="checkbox"/>	JP4	<input type="checkbox"/>	<input type="checkbox"/>	JP5	<input checked="" type="checkbox"/>	<input checked="" type="checkbox"/>	JP6	<input type="checkbox"/>	<input type="checkbox"/>	JP9	<input checked="" type="checkbox"/>	<input checked="" type="checkbox"/>	JP10	<table border="0"> <tr><td>1</td><td>2</td><td></td></tr> <tr><td><input type="checkbox"/></td><td><input type="checkbox"/></td><td>JP14</td></tr> <tr><td><input checked="" type="checkbox"/></td><td><input checked="" type="checkbox"/></td><td>JP15</td></tr> <tr><td><input type="checkbox"/></td><td><input type="checkbox"/></td><td>JP16</td></tr> <tr><td><input type="checkbox"/></td><td><input type="checkbox"/></td><td>JP17</td></tr> <tr><td><input type="checkbox"/></td><td><input type="checkbox"/></td><td>JP18</td></tr> </table>	1	2		<input type="checkbox"/>	<input type="checkbox"/>	JP14	<input checked="" type="checkbox"/>	<input checked="" type="checkbox"/>	JP15	<input type="checkbox"/>	<input type="checkbox"/>	JP16	<input type="checkbox"/>	<input type="checkbox"/>	JP17	<input type="checkbox"/>
1	2																																																																																												
<input type="checkbox"/>	<input type="checkbox"/>	JP1																																																																																											
<input checked="" type="checkbox"/>	<input checked="" type="checkbox"/>	JP2																																																																																											
<input checked="" type="checkbox"/>	<input checked="" type="checkbox"/>	JP3																																																																																											
<input type="checkbox"/>	<input type="checkbox"/>	JP4																																																																																											
<input type="checkbox"/>	<input type="checkbox"/>	JP5																																																																																											
<input checked="" type="checkbox"/>	<input checked="" type="checkbox"/>	JP6																																																																																											
<input checked="" type="checkbox"/>	<input checked="" type="checkbox"/>	JP9																																																																																											
<input checked="" type="checkbox"/>	<input checked="" type="checkbox"/>	JP10																																																																																											
1	2																																																																																												
<input type="checkbox"/>	<input type="checkbox"/>	JP14																																																																																											
<input checked="" type="checkbox"/>	<input checked="" type="checkbox"/>	JP15																																																																																											
<input type="checkbox"/>	<input type="checkbox"/>	JP16																																																																																											
<input type="checkbox"/>	<input type="checkbox"/>	JP17																																																																																											
<input type="checkbox"/>	<input type="checkbox"/>	JP18																																																																																											
1	2																																																																																												
<input checked="" type="checkbox"/>	<input checked="" type="checkbox"/>	JP1																																																																																											
<input type="checkbox"/>	<input type="checkbox"/>	JP2																																																																																											
<input type="checkbox"/>	<input type="checkbox"/>	JP3																																																																																											
<input checked="" type="checkbox"/>	<input checked="" type="checkbox"/>	JP4																																																																																											
<input type="checkbox"/>	<input type="checkbox"/>	JP5																																																																																											
<input checked="" type="checkbox"/>	<input checked="" type="checkbox"/>	JP6																																																																																											
<input type="checkbox"/>	<input type="checkbox"/>	JP9																																																																																											
<input checked="" type="checkbox"/>	<input checked="" type="checkbox"/>	JP10																																																																																											
1	2																																																																																												
<input type="checkbox"/>	<input type="checkbox"/>	JP14																																																																																											
<input checked="" type="checkbox"/>	<input checked="" type="checkbox"/>	JP15																																																																																											
<input type="checkbox"/>	<input type="checkbox"/>	JP16																																																																																											
<input type="checkbox"/>	<input type="checkbox"/>	JP17																																																																																											
<input type="checkbox"/>	<input type="checkbox"/>	JP18																																																																																											

CPU TYPE	JP1~6, JP9~10	JP14~JP18	CPU TYPE	JP1~6, JP9~10	JP14~JP18																																																																																								
AMD K6-2/400	100MHz x 4	V <sub>CORE</sub> = 2.2V	AMD K6-2/450	100MHz x 4.5	V <sub>CORE</sub> = 2.4V																																																																																								
	<table border="0"> <tr><td>1</td><td>2</td><td></td></tr> <tr><td><input type="checkbox"/></td><td><input type="checkbox"/></td><td>JP1</td></tr> <tr><td><input type="checkbox"/></td><td><input type="checkbox"/></td><td>JP2</td></tr> <tr><td><input type="checkbox"/></td><td><input type="checkbox"/></td><td>JP3</td></tr> <tr><td><input checked="" type="checkbox"/></td><td><input checked="" type="checkbox"/></td><td>JP4</td></tr> <tr><td><input type="checkbox"/></td><td><input type="checkbox"/></td><td>JP5</td></tr> <tr><td><input checked="" type="checkbox"/></td><td><input checked="" type="checkbox"/></td><td>JP6</td></tr> <tr><td><input type="checkbox"/></td><td><input type="checkbox"/></td><td>JP9</td></tr> <tr><td><input checked="" type="checkbox"/></td><td><input checked="" type="checkbox"/></td><td>JP10</td></tr> </table>	1		2		<input type="checkbox"/>	<input type="checkbox"/>	JP1	<input type="checkbox"/>	<input type="checkbox"/>	JP2	<input type="checkbox"/>	<input type="checkbox"/>	JP3	<input checked="" type="checkbox"/>	<input checked="" type="checkbox"/>	JP4	<input type="checkbox"/>	<input type="checkbox"/>	JP5	<input checked="" type="checkbox"/>	<input checked="" type="checkbox"/>	JP6	<input type="checkbox"/>	<input type="checkbox"/>	JP9	<input checked="" type="checkbox"/>	<input checked="" type="checkbox"/>	JP10	<table border="0"> <tr><td>1</td><td>2</td><td></td></tr> <tr><td><input type="checkbox"/></td><td><input type="checkbox"/></td><td>JP14</td></tr> <tr><td><input checked="" type="checkbox"/></td><td><input checked="" type="checkbox"/></td><td>JP15</td></tr> <tr><td><input type="checkbox"/></td><td><input type="checkbox"/></td><td>JP16</td></tr> <tr><td><input type="checkbox"/></td><td><input type="checkbox"/></td><td>JP17</td></tr> <tr><td><input type="checkbox"/></td><td><input type="checkbox"/></td><td>JP18</td></tr> </table>	1	2		<input type="checkbox"/>	<input type="checkbox"/>	JP14	<input checked="" type="checkbox"/>	<input checked="" type="checkbox"/>	JP15	<input type="checkbox"/>	<input type="checkbox"/>	JP16	<input type="checkbox"/>	<input type="checkbox"/>	JP17	<input type="checkbox"/>	<input type="checkbox"/>	JP18	<table border="0"> <tr><td>1</td><td>2</td><td></td></tr> <tr><td><input type="checkbox"/></td><td><input type="checkbox"/></td><td>JP1</td></tr> <tr><td><input type="checkbox"/></td><td><input type="checkbox"/></td><td>JP2</td></tr> <tr><td><input type="checkbox"/></td><td><input type="checkbox"/></td><td>JP3</td></tr> <tr><td><input checked="" type="checkbox"/></td><td><input checked="" type="checkbox"/></td><td>JP4</td></tr> <tr><td><input checked="" type="checkbox"/></td><td><input checked="" type="checkbox"/></td><td>JP5</td></tr> <tr><td><input checked="" type="checkbox"/></td><td><input checked="" type="checkbox"/></td><td>JP6</td></tr> <tr><td><input type="checkbox"/></td><td><input type="checkbox"/></td><td>JP9</td></tr> <tr><td><input checked="" type="checkbox"/></td><td><input checked="" type="checkbox"/></td><td>JP10</td></tr> </table>	1	2		<input type="checkbox"/>	<input type="checkbox"/>	JP1	<input type="checkbox"/>	<input type="checkbox"/>	JP2	<input type="checkbox"/>	<input type="checkbox"/>	JP3	<input checked="" type="checkbox"/>	<input checked="" type="checkbox"/>	JP4	<input checked="" type="checkbox"/>	<input checked="" type="checkbox"/>	JP5	<input checked="" type="checkbox"/>	<input checked="" type="checkbox"/>	JP6	<input type="checkbox"/>	<input type="checkbox"/>	JP9	<input checked="" type="checkbox"/>	<input checked="" type="checkbox"/>	JP10	<table border="0"> <tr><td>1</td><td>2</td><td></td></tr> <tr><td><input type="checkbox"/></td><td><input type="checkbox"/></td><td>JP14</td></tr> <tr><td><input type="checkbox"/></td><td><input type="checkbox"/></td><td>JP15</td></tr> <tr><td><input checked="" type="checkbox"/></td><td><input checked="" type="checkbox"/></td><td>JP16</td></tr> <tr><td><input type="checkbox"/></td><td><input type="checkbox"/></td><td>JP17</td></tr> <tr><td><input type="checkbox"/></td><td><input type="checkbox"/></td><td>JP18</td></tr> </table>	1	2		<input type="checkbox"/>	<input type="checkbox"/>	JP14	<input type="checkbox"/>	<input type="checkbox"/>	JP15	<input checked="" type="checkbox"/>	<input checked="" type="checkbox"/>	JP16	<input type="checkbox"/>	<input type="checkbox"/>	JP17	<input type="checkbox"/>
1	2																																																																																												
<input type="checkbox"/>	<input type="checkbox"/>	JP1																																																																																											
<input type="checkbox"/>	<input type="checkbox"/>	JP2																																																																																											
<input type="checkbox"/>	<input type="checkbox"/>	JP3																																																																																											
<input checked="" type="checkbox"/>	<input checked="" type="checkbox"/>	JP4																																																																																											
<input type="checkbox"/>	<input type="checkbox"/>	JP5																																																																																											
<input checked="" type="checkbox"/>	<input checked="" type="checkbox"/>	JP6																																																																																											
<input type="checkbox"/>	<input type="checkbox"/>	JP9																																																																																											
<input checked="" type="checkbox"/>	<input checked="" type="checkbox"/>	JP10																																																																																											
1	2																																																																																												
<input type="checkbox"/>	<input type="checkbox"/>	JP14																																																																																											
<input checked="" type="checkbox"/>	<input checked="" type="checkbox"/>	JP15																																																																																											
<input type="checkbox"/>	<input type="checkbox"/>	JP16																																																																																											
<input type="checkbox"/>	<input type="checkbox"/>	JP17																																																																																											
<input type="checkbox"/>	<input type="checkbox"/>	JP18																																																																																											
1	2																																																																																												
<input type="checkbox"/>	<input type="checkbox"/>	JP1																																																																																											
<input type="checkbox"/>	<input type="checkbox"/>	JP2																																																																																											
<input type="checkbox"/>	<input type="checkbox"/>	JP3																																																																																											
<input checked="" type="checkbox"/>	<input checked="" type="checkbox"/>	JP4																																																																																											
<input checked="" type="checkbox"/>	<input checked="" type="checkbox"/>	JP5																																																																																											
<input checked="" type="checkbox"/>	<input checked="" type="checkbox"/>	JP6																																																																																											
<input type="checkbox"/>	<input type="checkbox"/>	JP9																																																																																											
<input checked="" type="checkbox"/>	<input checked="" type="checkbox"/>	JP10																																																																																											
1	2																																																																																												
<input type="checkbox"/>	<input type="checkbox"/>	JP14																																																																																											
<input type="checkbox"/>	<input type="checkbox"/>	JP15																																																																																											
<input checked="" type="checkbox"/>	<input checked="" type="checkbox"/>	JP16																																																																																											
<input type="checkbox"/>	<input type="checkbox"/>	JP17																																																																																											
<input type="checkbox"/>	<input type="checkbox"/>	JP18																																																																																											
AMD K6-3/400	100MHz x 4	V <sub>CORE</sub> = 2.4V	AMD K6-3/450	100MHz x 4.5	V <sub>CORE</sub> = 2.4V																																																																																								
	<table border="0"> <tr><td>1</td><td>2</td><td></td></tr> <tr><td><input type="checkbox"/></td><td><input type="checkbox"/></td><td>JP1</td></tr> <tr><td><input type="checkbox"/></td><td><input type="checkbox"/></td><td>JP2</td></tr> <tr><td><input type="checkbox"/></td><td><input type="checkbox"/></td><td>JP3</td></tr> <tr><td><input checked="" type="checkbox"/></td><td><input checked="" type="checkbox"/></td><td>JP4</td></tr> <tr><td><input type="checkbox"/></td><td><input type="checkbox"/></td><td>JP5</td></tr> <tr><td><input checked="" type="checkbox"/></td><td><input checked="" type="checkbox"/></td><td>JP6</td></tr> <tr><td><input type="checkbox"/></td><td><input type="checkbox"/></td><td>JP9</td></tr> <tr><td><input checked="" type="checkbox"/></td><td><input checked="" type="checkbox"/></td><td>JP10</td></tr> </table>	1		2		<input type="checkbox"/>	<input type="checkbox"/>	JP1	<input type="checkbox"/>	<input type="checkbox"/>	JP2	<input type="checkbox"/>	<input type="checkbox"/>	JP3	<input checked="" type="checkbox"/>	<input checked="" type="checkbox"/>	JP4	<input type="checkbox"/>	<input type="checkbox"/>	JP5	<input checked="" type="checkbox"/>	<input checked="" type="checkbox"/>	JP6	<input type="checkbox"/>	<input type="checkbox"/>	JP9	<input checked="" type="checkbox"/>	<input checked="" type="checkbox"/>	JP10	<table border="0"> <tr><td>1</td><td>2</td><td></td></tr> <tr><td><input type="checkbox"/></td><td><input type="checkbox"/></td><td>JP14</td></tr> <tr><td><input type="checkbox"/></td><td><input type="checkbox"/></td><td>JP15</td></tr> <tr><td><input checked="" type="checkbox"/></td><td><input checked="" type="checkbox"/></td><td>JP16</td></tr> <tr><td><input type="checkbox"/></td><td><input type="checkbox"/></td><td>JP17</td></tr> <tr><td><input type="checkbox"/></td><td><input type="checkbox"/></td><td>JP18</td></tr> </table>	1	2		<input type="checkbox"/>	<input type="checkbox"/>	JP14	<input type="checkbox"/>	<input type="checkbox"/>	JP15	<input checked="" type="checkbox"/>	<input checked="" type="checkbox"/>	JP16	<input type="checkbox"/>	<input type="checkbox"/>	JP17	<input type="checkbox"/>	<input type="checkbox"/>	JP18	<table border="0"> <tr><td>1</td><td>2</td><td></td></tr> <tr><td><input type="checkbox"/></td><td><input type="checkbox"/></td><td>JP1</td></tr> <tr><td><input type="checkbox"/></td><td><input type="checkbox"/></td><td>JP2</td></tr> <tr><td><input type="checkbox"/></td><td><input type="checkbox"/></td><td>JP3</td></tr> <tr><td><input checked="" type="checkbox"/></td><td><input checked="" type="checkbox"/></td><td>JP4</td></tr> <tr><td><input checked="" type="checkbox"/></td><td><input checked="" type="checkbox"/></td><td>JP5</td></tr> <tr><td><input checked="" type="checkbox"/></td><td><input checked="" type="checkbox"/></td><td>JP6</td></tr> <tr><td><input type="checkbox"/></td><td><input type="checkbox"/></td><td>JP9</td></tr> <tr><td><input checked="" type="checkbox"/></td><td><input checked="" type="checkbox"/></td><td>JP10</td></tr> </table>	1	2		<input type="checkbox"/>	<input type="checkbox"/>	JP1	<input type="checkbox"/>	<input type="checkbox"/>	JP2	<input type="checkbox"/>	<input type="checkbox"/>	JP3	<input checked="" type="checkbox"/>	<input checked="" type="checkbox"/>	JP4	<input checked="" type="checkbox"/>	<input checked="" type="checkbox"/>	JP5	<input checked="" type="checkbox"/>	<input checked="" type="checkbox"/>	JP6	<input type="checkbox"/>	<input type="checkbox"/>	JP9	<input checked="" type="checkbox"/>	<input checked="" type="checkbox"/>	JP10	<table border="0"> <tr><td>1</td><td>2</td><td></td></tr> <tr><td><input type="checkbox"/></td><td><input type="checkbox"/></td><td>JP14</td></tr> <tr><td><input type="checkbox"/></td><td><input type="checkbox"/></td><td>JP15</td></tr> <tr><td><input checked="" type="checkbox"/></td><td><input checked="" type="checkbox"/></td><td>JP16</td></tr> <tr><td><input type="checkbox"/></td><td><input type="checkbox"/></td><td>JP17</td></tr> <tr><td><input type="checkbox"/></td><td><input type="checkbox"/></td><td>JP18</td></tr> </table>	1	2		<input type="checkbox"/>	<input type="checkbox"/>	JP14	<input type="checkbox"/>	<input type="checkbox"/>	JP15	<input checked="" type="checkbox"/>	<input checked="" type="checkbox"/>	JP16	<input type="checkbox"/>	<input type="checkbox"/>	JP17	<input type="checkbox"/>
1	2																																																																																												
<input type="checkbox"/>	<input type="checkbox"/>	JP1																																																																																											
<input type="checkbox"/>	<input type="checkbox"/>	JP2																																																																																											
<input type="checkbox"/>	<input type="checkbox"/>	JP3																																																																																											
<input checked="" type="checkbox"/>	<input checked="" type="checkbox"/>	JP4																																																																																											
<input type="checkbox"/>	<input type="checkbox"/>	JP5																																																																																											
<input checked="" type="checkbox"/>	<input checked="" type="checkbox"/>	JP6																																																																																											
<input type="checkbox"/>	<input type="checkbox"/>	JP9																																																																																											
<input checked="" type="checkbox"/>	<input checked="" type="checkbox"/>	JP10																																																																																											
1	2																																																																																												
<input type="checkbox"/>	<input type="checkbox"/>	JP14																																																																																											
<input type="checkbox"/>	<input type="checkbox"/>	JP15																																																																																											
<input checked="" type="checkbox"/>	<input checked="" type="checkbox"/>	JP16																																																																																											
<input type="checkbox"/>	<input type="checkbox"/>	JP17																																																																																											
<input type="checkbox"/>	<input type="checkbox"/>	JP18																																																																																											
1	2																																																																																												
<input type="checkbox"/>	<input type="checkbox"/>	JP1																																																																																											
<input type="checkbox"/>	<input type="checkbox"/>	JP2																																																																																											
<input type="checkbox"/>	<input type="checkbox"/>	JP3																																																																																											
<input checked="" type="checkbox"/>	<input checked="" type="checkbox"/>	JP4																																																																																											
<input checked="" type="checkbox"/>	<input checked="" type="checkbox"/>	JP5																																																																																											
<input checked="" type="checkbox"/>	<input checked="" type="checkbox"/>	JP6																																																																																											
<input type="checkbox"/>	<input type="checkbox"/>	JP9																																																																																											
<input checked="" type="checkbox"/>	<input checked="" type="checkbox"/>	JP10																																																																																											
1	2																																																																																												
<input type="checkbox"/>	<input type="checkbox"/>	JP14																																																																																											
<input type="checkbox"/>	<input type="checkbox"/>	JP15																																																																																											
<input checked="" type="checkbox"/>	<input checked="" type="checkbox"/>	JP16																																																																																											
<input type="checkbox"/>	<input type="checkbox"/>	JP17																																																																																											
<input type="checkbox"/>	<input type="checkbox"/>	JP18																																																																																											
Cyrrix / IBM 6x86 -P150+	60MHz x 2	V <sub>CORE</sub> = 3.5V	Cyrrix / IBM 6x86L -P150+	60MHz x 2	V <sub>CORE</sub> = 2.8V																																																																																								
	<table border="0"> <tr><td>1</td><td>2</td><td></td></tr> <tr><td><input checked="" type="checkbox"/></td><td><input checked="" type="checkbox"/></td><td>JP1</td></tr> <tr><td><input checked="" type="checkbox"/></td><td><input checked="" type="checkbox"/></td><td>JP2</td></tr> <tr><td><input checked="" type="checkbox"/></td><td><input checked="" type="checkbox"/></td><td>JP3</td></tr> <tr><td><input checked="" type="checkbox"/></td><td><input checked="" type="checkbox"/></td><td>JP4</td></tr> <tr><td><input type="checkbox"/></td><td><input type="checkbox"/></td><td>JP5</td></tr> <tr><td><input type="checkbox"/></td><td><input type="checkbox"/></td><td>JP6</td></tr> <tr><td><input checked="" type="checkbox"/></td><td><input checked="" type="checkbox"/></td><td>JP9</td></tr> <tr><td><input checked="" type="checkbox"/></td><td><input checked="" type="checkbox"/></td><td>JP10</td></tr> </table>	1		2		<input checked="" type="checkbox"/>	<input checked="" type="checkbox"/>	JP1	<input checked="" type="checkbox"/>	<input checked="" type="checkbox"/>	JP2	<input checked="" type="checkbox"/>	<input checked="" type="checkbox"/>	JP3	<input checked="" type="checkbox"/>	<input checked="" type="checkbox"/>	JP4	<input type="checkbox"/>	<input type="checkbox"/>	JP5	<input type="checkbox"/>	<input type="checkbox"/>	JP6	<input checked="" type="checkbox"/>	<input checked="" type="checkbox"/>	JP9	<input checked="" type="checkbox"/>	<input checked="" type="checkbox"/>	JP10	<table border="0"> <tr><td>1</td><td>2</td><td></td></tr> <tr><td><input checked="" type="checkbox"/></td><td><input checked="" type="checkbox"/></td><td>JP14</td></tr> <tr><td><input checked="" type="checkbox"/></td><td><input checked="" type="checkbox"/></td><td>JP15</td></tr> <tr><td><input checked="" type="checkbox"/></td><td><input checked="" type="checkbox"/></td><td>JP16</td></tr> <tr><td><input checked="" type="checkbox"/></td><td><input checked="" type="checkbox"/></td><td>JP17</td></tr> <tr><td><input type="checkbox"/></td><td><input type="checkbox"/></td><td>JP18</td></tr> </table>	1	2		<input checked="" type="checkbox"/>	<input checked="" type="checkbox"/>	JP14	<input checked="" type="checkbox"/>	<input checked="" type="checkbox"/>	JP15	<input checked="" type="checkbox"/>	<input checked="" type="checkbox"/>	JP16	<input checked="" type="checkbox"/>	<input checked="" type="checkbox"/>	JP17	<input type="checkbox"/>	<input type="checkbox"/>	JP18	<table border="0"> <tr><td>1</td><td>2</td><td></td></tr> <tr><td><input checked="" type="checkbox"/></td><td><input checked="" type="checkbox"/></td><td>JP1</td></tr> <tr><td><input checked="" type="checkbox"/></td><td><input checked="" type="checkbox"/></td><td>JP2</td></tr> <tr><td><input checked="" type="checkbox"/></td><td><input checked="" type="checkbox"/></td><td>JP3</td></tr> <tr><td><input checked="" type="checkbox"/></td><td><input checked="" type="checkbox"/></td><td>JP4</td></tr> <tr><td><input type="checkbox"/></td><td><input type="checkbox"/></td><td>JP5</td></tr> <tr><td><input type="checkbox"/></td><td><input type="checkbox"/></td><td>JP6</td></tr> <tr><td><input checked="" type="checkbox"/></td><td><input checked="" type="checkbox"/></td><td>JP9</td></tr> <tr><td><input checked="" type="checkbox"/></td><td><input checked="" type="checkbox"/></td><td>JP10</td></tr> </table>	1	2		<input checked="" type="checkbox"/>	<input checked="" type="checkbox"/>	JP1	<input checked="" type="checkbox"/>	<input checked="" type="checkbox"/>	JP2	<input checked="" type="checkbox"/>	<input checked="" type="checkbox"/>	JP3	<input checked="" type="checkbox"/>	<input checked="" type="checkbox"/>	JP4	<input type="checkbox"/>	<input type="checkbox"/>	JP5	<input type="checkbox"/>	<input type="checkbox"/>	JP6	<input checked="" type="checkbox"/>	<input checked="" type="checkbox"/>	JP9	<input checked="" type="checkbox"/>	<input checked="" type="checkbox"/>	JP10	<table border="0"> <tr><td>1</td><td>2</td><td></td></tr> <tr><td><input type="checkbox"/></td><td><input type="checkbox"/></td><td>JP14</td></tr> <tr><td><input type="checkbox"/></td><td><input type="checkbox"/></td><td>JP15</td></tr> <tr><td><input type="checkbox"/></td><td><input type="checkbox"/></td><td>JP16</td></tr> <tr><td><input checked="" type="checkbox"/></td><td><input checked="" type="checkbox"/></td><td>JP17</td></tr> <tr><td><input type="checkbox"/></td><td><input type="checkbox"/></td><td>JP18</td></tr> </table>	1	2		<input type="checkbox"/>	<input type="checkbox"/>	JP14	<input type="checkbox"/>	<input type="checkbox"/>	JP15	<input type="checkbox"/>	<input type="checkbox"/>	JP16	<input checked="" type="checkbox"/>	<input checked="" type="checkbox"/>	JP17	<input type="checkbox"/>
1	2																																																																																												
<input checked="" type="checkbox"/>	<input checked="" type="checkbox"/>	JP1																																																																																											
<input checked="" type="checkbox"/>	<input checked="" type="checkbox"/>	JP2																																																																																											
<input checked="" type="checkbox"/>	<input checked="" type="checkbox"/>	JP3																																																																																											
<input checked="" type="checkbox"/>	<input checked="" type="checkbox"/>	JP4																																																																																											
<input type="checkbox"/>	<input type="checkbox"/>	JP5																																																																																											
<input type="checkbox"/>	<input type="checkbox"/>	JP6																																																																																											
<input checked="" type="checkbox"/>	<input checked="" type="checkbox"/>	JP9																																																																																											
<input checked="" type="checkbox"/>	<input checked="" type="checkbox"/>	JP10																																																																																											
1	2																																																																																												
<input checked="" type="checkbox"/>	<input checked="" type="checkbox"/>	JP14																																																																																											
<input checked="" type="checkbox"/>	<input checked="" type="checkbox"/>	JP15																																																																																											
<input checked="" type="checkbox"/>	<input checked="" type="checkbox"/>	JP16																																																																																											
<input checked="" type="checkbox"/>	<input checked="" type="checkbox"/>	JP17																																																																																											
<input type="checkbox"/>	<input type="checkbox"/>	JP18																																																																																											
1	2																																																																																												
<input checked="" type="checkbox"/>	<input checked="" type="checkbox"/>	JP1																																																																																											
<input checked="" type="checkbox"/>	<input checked="" type="checkbox"/>	JP2																																																																																											
<input checked="" type="checkbox"/>	<input checked="" type="checkbox"/>	JP3																																																																																											
<input checked="" type="checkbox"/>	<input checked="" type="checkbox"/>	JP4																																																																																											
<input type="checkbox"/>	<input type="checkbox"/>	JP5																																																																																											
<input type="checkbox"/>	<input type="checkbox"/>	JP6																																																																																											
<input checked="" type="checkbox"/>	<input checked="" type="checkbox"/>	JP9																																																																																											
<input checked="" type="checkbox"/>	<input checked="" type="checkbox"/>	JP10																																																																																											
1	2																																																																																												
<input type="checkbox"/>	<input type="checkbox"/>	JP14																																																																																											
<input type="checkbox"/>	<input type="checkbox"/>	JP15																																																																																											
<input type="checkbox"/>	<input type="checkbox"/>	JP16																																																																																											
<input checked="" type="checkbox"/>	<input checked="" type="checkbox"/>	JP17																																																																																											
<input type="checkbox"/>	<input type="checkbox"/>	JP18																																																																																											

**MVP3 SYSTEM BOARD**

**HARDWARE SETUP**

CPU TYPE	JP1~6, JP9~10	JP14~JP18	CPU TYPE	JP1~6, JP9~10	JP14~JP18																																																																																								
Cyrilx / IBM 6x86 -P166+	66MHz x 2	V <sub>CORE</sub> = 3.5V	Cyrilx / IBM 6x86L -P166+	66MHz x 2	V <sub>CORE</sub> = 2.8V																																																																																								
	<table border="0"> <tr><td>1</td><td>2</td><td></td></tr> <tr><td><input type="checkbox"/></td><td><input type="checkbox"/></td><td>JP1</td></tr> <tr><td><input checked="" type="checkbox"/></td><td><input checked="" type="checkbox"/></td><td>JP2</td></tr> <tr><td><input checked="" type="checkbox"/></td><td><input checked="" type="checkbox"/></td><td>JP3</td></tr> <tr><td><input checked="" type="checkbox"/></td><td><input checked="" type="checkbox"/></td><td>JP4</td></tr> <tr><td><input type="checkbox"/></td><td><input type="checkbox"/></td><td>JP5</td></tr> <tr><td><input type="checkbox"/></td><td><input type="checkbox"/></td><td>JP6</td></tr> <tr><td><input checked="" type="checkbox"/></td><td><input checked="" type="checkbox"/></td><td>JP9</td></tr> <tr><td><input checked="" type="checkbox"/></td><td><input checked="" type="checkbox"/></td><td>JP10</td></tr> </table>	1		2		<input type="checkbox"/>	<input type="checkbox"/>	JP1	<input checked="" type="checkbox"/>	<input checked="" type="checkbox"/>	JP2	<input checked="" type="checkbox"/>	<input checked="" type="checkbox"/>	JP3	<input checked="" type="checkbox"/>	<input checked="" type="checkbox"/>	JP4	<input type="checkbox"/>	<input type="checkbox"/>	JP5	<input type="checkbox"/>	<input type="checkbox"/>	JP6	<input checked="" type="checkbox"/>	<input checked="" type="checkbox"/>	JP9	<input checked="" type="checkbox"/>	<input checked="" type="checkbox"/>	JP10	<table border="0"> <tr><td>1</td><td>2</td><td></td></tr> <tr><td><input checked="" type="checkbox"/></td><td><input checked="" type="checkbox"/></td><td>JP14</td></tr> <tr><td><input checked="" type="checkbox"/></td><td><input checked="" type="checkbox"/></td><td>JP15</td></tr> <tr><td><input checked="" type="checkbox"/></td><td><input checked="" type="checkbox"/></td><td>JP16</td></tr> <tr><td><input checked="" type="checkbox"/></td><td><input checked="" type="checkbox"/></td><td>JP17</td></tr> <tr><td><input type="checkbox"/></td><td><input type="checkbox"/></td><td>JP18</td></tr> </table>	1	2		<input checked="" type="checkbox"/>	<input checked="" type="checkbox"/>	JP14	<input checked="" type="checkbox"/>	<input checked="" type="checkbox"/>	JP15	<input checked="" type="checkbox"/>	<input checked="" type="checkbox"/>	JP16	<input checked="" type="checkbox"/>	<input checked="" type="checkbox"/>	JP17	<input type="checkbox"/>	<input type="checkbox"/>	JP18	<table border="0"> <tr><td>1</td><td>2</td><td></td></tr> <tr><td><input type="checkbox"/></td><td><input type="checkbox"/></td><td>JP1</td></tr> <tr><td><input checked="" type="checkbox"/></td><td><input checked="" type="checkbox"/></td><td>JP2</td></tr> <tr><td><input checked="" type="checkbox"/></td><td><input checked="" type="checkbox"/></td><td>JP3</td></tr> <tr><td><input checked="" type="checkbox"/></td><td><input checked="" type="checkbox"/></td><td>JP4</td></tr> <tr><td><input type="checkbox"/></td><td><input type="checkbox"/></td><td>JP5</td></tr> <tr><td><input type="checkbox"/></td><td><input type="checkbox"/></td><td>JP6</td></tr> <tr><td><input checked="" type="checkbox"/></td><td><input checked="" type="checkbox"/></td><td>JP9</td></tr> <tr><td><input checked="" type="checkbox"/></td><td><input checked="" type="checkbox"/></td><td>JP10</td></tr> </table>	1	2		<input type="checkbox"/>	<input type="checkbox"/>	JP1	<input checked="" type="checkbox"/>	<input checked="" type="checkbox"/>	JP2	<input checked="" type="checkbox"/>	<input checked="" type="checkbox"/>	JP3	<input checked="" type="checkbox"/>	<input checked="" type="checkbox"/>	JP4	<input type="checkbox"/>	<input type="checkbox"/>	JP5	<input type="checkbox"/>	<input type="checkbox"/>	JP6	<input checked="" type="checkbox"/>	<input checked="" type="checkbox"/>	JP9	<input checked="" type="checkbox"/>	<input checked="" type="checkbox"/>	JP10	<table border="0"> <tr><td>1</td><td>2</td><td></td></tr> <tr><td><input type="checkbox"/></td><td><input type="checkbox"/></td><td>JP14</td></tr> <tr><td><input type="checkbox"/></td><td><input type="checkbox"/></td><td>JP15</td></tr> <tr><td><input type="checkbox"/></td><td><input type="checkbox"/></td><td>JP16</td></tr> <tr><td><input checked="" type="checkbox"/></td><td><input checked="" type="checkbox"/></td><td>JP17</td></tr> <tr><td><input type="checkbox"/></td><td><input type="checkbox"/></td><td>JP18</td></tr> </table>	1	2		<input type="checkbox"/>	<input type="checkbox"/>	JP14	<input type="checkbox"/>	<input type="checkbox"/>	JP15	<input type="checkbox"/>	<input type="checkbox"/>	JP16	<input checked="" type="checkbox"/>	<input checked="" type="checkbox"/>	JP17	<input type="checkbox"/>
1	2																																																																																												
<input type="checkbox"/>	<input type="checkbox"/>	JP1																																																																																											
<input checked="" type="checkbox"/>	<input checked="" type="checkbox"/>	JP2																																																																																											
<input checked="" type="checkbox"/>	<input checked="" type="checkbox"/>	JP3																																																																																											
<input checked="" type="checkbox"/>	<input checked="" type="checkbox"/>	JP4																																																																																											
<input type="checkbox"/>	<input type="checkbox"/>	JP5																																																																																											
<input type="checkbox"/>	<input type="checkbox"/>	JP6																																																																																											
<input checked="" type="checkbox"/>	<input checked="" type="checkbox"/>	JP9																																																																																											
<input checked="" type="checkbox"/>	<input checked="" type="checkbox"/>	JP10																																																																																											
1	2																																																																																												
<input checked="" type="checkbox"/>	<input checked="" type="checkbox"/>	JP14																																																																																											
<input checked="" type="checkbox"/>	<input checked="" type="checkbox"/>	JP15																																																																																											
<input checked="" type="checkbox"/>	<input checked="" type="checkbox"/>	JP16																																																																																											
<input checked="" type="checkbox"/>	<input checked="" type="checkbox"/>	JP17																																																																																											
<input type="checkbox"/>	<input type="checkbox"/>	JP18																																																																																											
1	2																																																																																												
<input type="checkbox"/>	<input type="checkbox"/>	JP1																																																																																											
<input checked="" type="checkbox"/>	<input checked="" type="checkbox"/>	JP2																																																																																											
<input checked="" type="checkbox"/>	<input checked="" type="checkbox"/>	JP3																																																																																											
<input checked="" type="checkbox"/>	<input checked="" type="checkbox"/>	JP4																																																																																											
<input type="checkbox"/>	<input type="checkbox"/>	JP5																																																																																											
<input type="checkbox"/>	<input type="checkbox"/>	JP6																																																																																											
<input checked="" type="checkbox"/>	<input checked="" type="checkbox"/>	JP9																																																																																											
<input checked="" type="checkbox"/>	<input checked="" type="checkbox"/>	JP10																																																																																											
1	2																																																																																												
<input type="checkbox"/>	<input type="checkbox"/>	JP14																																																																																											
<input type="checkbox"/>	<input type="checkbox"/>	JP15																																																																																											
<input type="checkbox"/>	<input type="checkbox"/>	JP16																																																																																											
<input checked="" type="checkbox"/>	<input checked="" type="checkbox"/>	JP17																																																																																											
<input type="checkbox"/>	<input type="checkbox"/>	JP18																																																																																											
Cyrilx / IBM 6x86 -P200+	75MHz x 2	V <sub>CORE</sub> = 3.5V	Cyrilx / IBM 6x86L -P200+	75MHz x 2	V <sub>CORE</sub> = 2.8V																																																																																								
	<table border="0"> <tr><td>1</td><td>2</td><td></td></tr> <tr><td><input checked="" type="checkbox"/></td><td><input checked="" type="checkbox"/></td><td>JP1</td></tr> <tr><td><input checked="" type="checkbox"/></td><td><input checked="" type="checkbox"/></td><td>JP2</td></tr> <tr><td><input type="checkbox"/></td><td><input type="checkbox"/></td><td>JP3</td></tr> <tr><td><input checked="" type="checkbox"/></td><td><input checked="" type="checkbox"/></td><td>JP4</td></tr> <tr><td><input type="checkbox"/></td><td><input type="checkbox"/></td><td>JP5</td></tr> <tr><td><input type="checkbox"/></td><td><input type="checkbox"/></td><td>JP6</td></tr> <tr><td><input type="checkbox"/></td><td><input type="checkbox"/></td><td>JP9</td></tr> <tr><td><input type="checkbox"/></td><td><input type="checkbox"/></td><td>JP10</td></tr> </table>	1		2		<input checked="" type="checkbox"/>	<input checked="" type="checkbox"/>	JP1	<input checked="" type="checkbox"/>	<input checked="" type="checkbox"/>	JP2	<input type="checkbox"/>	<input type="checkbox"/>	JP3	<input checked="" type="checkbox"/>	<input checked="" type="checkbox"/>	JP4	<input type="checkbox"/>	<input type="checkbox"/>	JP5	<input type="checkbox"/>	<input type="checkbox"/>	JP6	<input type="checkbox"/>	<input type="checkbox"/>	JP9	<input type="checkbox"/>	<input type="checkbox"/>	JP10	<table border="0"> <tr><td>1</td><td>2</td><td></td></tr> <tr><td><input checked="" type="checkbox"/></td><td><input checked="" type="checkbox"/></td><td>JP14</td></tr> <tr><td><input checked="" type="checkbox"/></td><td><input checked="" type="checkbox"/></td><td>JP15</td></tr> <tr><td><input checked="" type="checkbox"/></td><td><input checked="" type="checkbox"/></td><td>JP16</td></tr> <tr><td><input checked="" type="checkbox"/></td><td><input checked="" type="checkbox"/></td><td>JP17</td></tr> <tr><td><input type="checkbox"/></td><td><input type="checkbox"/></td><td>JP18</td></tr> </table>	1	2		<input checked="" type="checkbox"/>	<input checked="" type="checkbox"/>	JP14	<input checked="" type="checkbox"/>	<input checked="" type="checkbox"/>	JP15	<input checked="" type="checkbox"/>	<input checked="" type="checkbox"/>	JP16	<input checked="" type="checkbox"/>	<input checked="" type="checkbox"/>	JP17	<input type="checkbox"/>	<input type="checkbox"/>	JP18	<table border="0"> <tr><td>1</td><td>2</td><td></td></tr> <tr><td><input checked="" type="checkbox"/></td><td><input checked="" type="checkbox"/></td><td>JP1</td></tr> <tr><td><input checked="" type="checkbox"/></td><td><input checked="" type="checkbox"/></td><td>JP2</td></tr> <tr><td><input type="checkbox"/></td><td><input type="checkbox"/></td><td>JP3</td></tr> <tr><td><input checked="" type="checkbox"/></td><td><input checked="" type="checkbox"/></td><td>JP4</td></tr> <tr><td><input type="checkbox"/></td><td><input type="checkbox"/></td><td>JP5</td></tr> <tr><td><input type="checkbox"/></td><td><input type="checkbox"/></td><td>JP6</td></tr> <tr><td><input type="checkbox"/></td><td><input type="checkbox"/></td><td>JP9</td></tr> <tr><td><input type="checkbox"/></td><td><input type="checkbox"/></td><td>JP10</td></tr> </table>	1	2		<input checked="" type="checkbox"/>	<input checked="" type="checkbox"/>	JP1	<input checked="" type="checkbox"/>	<input checked="" type="checkbox"/>	JP2	<input type="checkbox"/>	<input type="checkbox"/>	JP3	<input checked="" type="checkbox"/>	<input checked="" type="checkbox"/>	JP4	<input type="checkbox"/>	<input type="checkbox"/>	JP5	<input type="checkbox"/>	<input type="checkbox"/>	JP6	<input type="checkbox"/>	<input type="checkbox"/>	JP9	<input type="checkbox"/>	<input type="checkbox"/>	JP10	<table border="0"> <tr><td>1</td><td>2</td><td></td></tr> <tr><td><input type="checkbox"/></td><td><input type="checkbox"/></td><td>JP14</td></tr> <tr><td><input type="checkbox"/></td><td><input type="checkbox"/></td><td>JP15</td></tr> <tr><td><input type="checkbox"/></td><td><input type="checkbox"/></td><td>JP16</td></tr> <tr><td><input checked="" type="checkbox"/></td><td><input checked="" type="checkbox"/></td><td>JP17</td></tr> <tr><td><input type="checkbox"/></td><td><input type="checkbox"/></td><td>JP18</td></tr> </table>	1	2		<input type="checkbox"/>	<input type="checkbox"/>	JP14	<input type="checkbox"/>	<input type="checkbox"/>	JP15	<input type="checkbox"/>	<input type="checkbox"/>	JP16	<input checked="" type="checkbox"/>	<input checked="" type="checkbox"/>	JP17	<input type="checkbox"/>
1	2																																																																																												
<input checked="" type="checkbox"/>	<input checked="" type="checkbox"/>	JP1																																																																																											
<input checked="" type="checkbox"/>	<input checked="" type="checkbox"/>	JP2																																																																																											
<input type="checkbox"/>	<input type="checkbox"/>	JP3																																																																																											
<input checked="" type="checkbox"/>	<input checked="" type="checkbox"/>	JP4																																																																																											
<input type="checkbox"/>	<input type="checkbox"/>	JP5																																																																																											
<input type="checkbox"/>	<input type="checkbox"/>	JP6																																																																																											
<input type="checkbox"/>	<input type="checkbox"/>	JP9																																																																																											
<input type="checkbox"/>	<input type="checkbox"/>	JP10																																																																																											
1	2																																																																																												
<input checked="" type="checkbox"/>	<input checked="" type="checkbox"/>	JP14																																																																																											
<input checked="" type="checkbox"/>	<input checked="" type="checkbox"/>	JP15																																																																																											
<input checked="" type="checkbox"/>	<input checked="" type="checkbox"/>	JP16																																																																																											
<input checked="" type="checkbox"/>	<input checked="" type="checkbox"/>	JP17																																																																																											
<input type="checkbox"/>	<input type="checkbox"/>	JP18																																																																																											
1	2																																																																																												
<input checked="" type="checkbox"/>	<input checked="" type="checkbox"/>	JP1																																																																																											
<input checked="" type="checkbox"/>	<input checked="" type="checkbox"/>	JP2																																																																																											
<input type="checkbox"/>	<input type="checkbox"/>	JP3																																																																																											
<input checked="" type="checkbox"/>	<input checked="" type="checkbox"/>	JP4																																																																																											
<input type="checkbox"/>	<input type="checkbox"/>	JP5																																																																																											
<input type="checkbox"/>	<input type="checkbox"/>	JP6																																																																																											
<input type="checkbox"/>	<input type="checkbox"/>	JP9																																																																																											
<input type="checkbox"/>	<input type="checkbox"/>	JP10																																																																																											
1	2																																																																																												
<input type="checkbox"/>	<input type="checkbox"/>	JP14																																																																																											
<input type="checkbox"/>	<input type="checkbox"/>	JP15																																																																																											
<input type="checkbox"/>	<input type="checkbox"/>	JP16																																																																																											
<input checked="" type="checkbox"/>	<input checked="" type="checkbox"/>	JP17																																																																																											
<input type="checkbox"/>	<input type="checkbox"/>	JP18																																																																																											
Cyrilx / IBM 6x86MX -PR166	66MHz x 2	V <sub>CORE</sub> = 2.9V	Cyrilx / IBM 6x86MX -PR200 (66MHz Bus)	66MHz x 2.5	V <sub>CORE</sub> = 2.9V																																																																																								
	<table border="0"> <tr><td>1</td><td>2</td><td></td></tr> <tr><td><input type="checkbox"/></td><td><input type="checkbox"/></td><td>JP1</td></tr> <tr><td><input checked="" type="checkbox"/></td><td><input checked="" type="checkbox"/></td><td>JP2</td></tr> <tr><td><input checked="" type="checkbox"/></td><td><input checked="" type="checkbox"/></td><td>JP3</td></tr> <tr><td><input checked="" type="checkbox"/></td><td><input checked="" type="checkbox"/></td><td>JP4</td></tr> <tr><td><input type="checkbox"/></td><td><input type="checkbox"/></td><td>JP5</td></tr> <tr><td><input type="checkbox"/></td><td><input type="checkbox"/></td><td>JP6</td></tr> <tr><td><input checked="" type="checkbox"/></td><td><input checked="" type="checkbox"/></td><td>JP9</td></tr> <tr><td><input checked="" type="checkbox"/></td><td><input checked="" type="checkbox"/></td><td>JP10</td></tr> </table>	1		2		<input type="checkbox"/>	<input type="checkbox"/>	JP1	<input checked="" type="checkbox"/>	<input checked="" type="checkbox"/>	JP2	<input checked="" type="checkbox"/>	<input checked="" type="checkbox"/>	JP3	<input checked="" type="checkbox"/>	<input checked="" type="checkbox"/>	JP4	<input type="checkbox"/>	<input type="checkbox"/>	JP5	<input type="checkbox"/>	<input type="checkbox"/>	JP6	<input checked="" type="checkbox"/>	<input checked="" type="checkbox"/>	JP9	<input checked="" type="checkbox"/>	<input checked="" type="checkbox"/>	JP10	<table border="0"> <tr><td>1</td><td>2</td><td></td></tr> <tr><td><input checked="" type="checkbox"/></td><td><input checked="" type="checkbox"/></td><td>JP14</td></tr> <tr><td><input type="checkbox"/></td><td><input type="checkbox"/></td><td>JP15</td></tr> <tr><td><input type="checkbox"/></td><td><input type="checkbox"/></td><td>JP16</td></tr> <tr><td><input checked="" type="checkbox"/></td><td><input checked="" type="checkbox"/></td><td>JP17</td></tr> <tr><td><input type="checkbox"/></td><td><input type="checkbox"/></td><td>JP18</td></tr> </table>	1	2		<input checked="" type="checkbox"/>	<input checked="" type="checkbox"/>	JP14	<input type="checkbox"/>	<input type="checkbox"/>	JP15	<input type="checkbox"/>	<input type="checkbox"/>	JP16	<input checked="" type="checkbox"/>	<input checked="" type="checkbox"/>	JP17	<input type="checkbox"/>	<input type="checkbox"/>	JP18	<table border="0"> <tr><td>1</td><td>2</td><td></td></tr> <tr><td><input type="checkbox"/></td><td><input type="checkbox"/></td><td>JP1</td></tr> <tr><td><input checked="" type="checkbox"/></td><td><input checked="" type="checkbox"/></td><td>JP2</td></tr> <tr><td><input checked="" type="checkbox"/></td><td><input checked="" type="checkbox"/></td><td>JP3</td></tr> <tr><td><input checked="" type="checkbox"/></td><td><input checked="" type="checkbox"/></td><td>JP4</td></tr> <tr><td><input checked="" type="checkbox"/></td><td><input checked="" type="checkbox"/></td><td>JP5</td></tr> <tr><td><input type="checkbox"/></td><td><input type="checkbox"/></td><td>JP6</td></tr> <tr><td><input checked="" type="checkbox"/></td><td><input checked="" type="checkbox"/></td><td>JP9</td></tr> <tr><td><input checked="" type="checkbox"/></td><td><input checked="" type="checkbox"/></td><td>JP10</td></tr> </table>	1	2		<input type="checkbox"/>	<input type="checkbox"/>	JP1	<input checked="" type="checkbox"/>	<input checked="" type="checkbox"/>	JP2	<input checked="" type="checkbox"/>	<input checked="" type="checkbox"/>	JP3	<input checked="" type="checkbox"/>	<input checked="" type="checkbox"/>	JP4	<input checked="" type="checkbox"/>	<input checked="" type="checkbox"/>	JP5	<input type="checkbox"/>	<input type="checkbox"/>	JP6	<input checked="" type="checkbox"/>	<input checked="" type="checkbox"/>	JP9	<input checked="" type="checkbox"/>	<input checked="" type="checkbox"/>	JP10	<table border="0"> <tr><td>1</td><td>2</td><td></td></tr> <tr><td><input checked="" type="checkbox"/></td><td><input checked="" type="checkbox"/></td><td>JP14</td></tr> <tr><td><input type="checkbox"/></td><td><input type="checkbox"/></td><td>JP15</td></tr> <tr><td><input type="checkbox"/></td><td><input type="checkbox"/></td><td>JP16</td></tr> <tr><td><input checked="" type="checkbox"/></td><td><input checked="" type="checkbox"/></td><td>JP17</td></tr> <tr><td><input type="checkbox"/></td><td><input type="checkbox"/></td><td>JP18</td></tr> </table>	1	2		<input checked="" type="checkbox"/>	<input checked="" type="checkbox"/>	JP14	<input type="checkbox"/>	<input type="checkbox"/>	JP15	<input type="checkbox"/>	<input type="checkbox"/>	JP16	<input checked="" type="checkbox"/>	<input checked="" type="checkbox"/>	JP17	<input type="checkbox"/>
1	2																																																																																												
<input type="checkbox"/>	<input type="checkbox"/>	JP1																																																																																											
<input checked="" type="checkbox"/>	<input checked="" type="checkbox"/>	JP2																																																																																											
<input checked="" type="checkbox"/>	<input checked="" type="checkbox"/>	JP3																																																																																											
<input checked="" type="checkbox"/>	<input checked="" type="checkbox"/>	JP4																																																																																											
<input type="checkbox"/>	<input type="checkbox"/>	JP5																																																																																											
<input type="checkbox"/>	<input type="checkbox"/>	JP6																																																																																											
<input checked="" type="checkbox"/>	<input checked="" type="checkbox"/>	JP9																																																																																											
<input checked="" type="checkbox"/>	<input checked="" type="checkbox"/>	JP10																																																																																											
1	2																																																																																												
<input checked="" type="checkbox"/>	<input checked="" type="checkbox"/>	JP14																																																																																											
<input type="checkbox"/>	<input type="checkbox"/>	JP15																																																																																											
<input type="checkbox"/>	<input type="checkbox"/>	JP16																																																																																											
<input checked="" type="checkbox"/>	<input checked="" type="checkbox"/>	JP17																																																																																											
<input type="checkbox"/>	<input type="checkbox"/>	JP18																																																																																											
1	2																																																																																												
<input type="checkbox"/>	<input type="checkbox"/>	JP1																																																																																											
<input checked="" type="checkbox"/>	<input checked="" type="checkbox"/>	JP2																																																																																											
<input checked="" type="checkbox"/>	<input checked="" type="checkbox"/>	JP3																																																																																											
<input checked="" type="checkbox"/>	<input checked="" type="checkbox"/>	JP4																																																																																											
<input checked="" type="checkbox"/>	<input checked="" type="checkbox"/>	JP5																																																																																											
<input type="checkbox"/>	<input type="checkbox"/>	JP6																																																																																											
<input checked="" type="checkbox"/>	<input checked="" type="checkbox"/>	JP9																																																																																											
<input checked="" type="checkbox"/>	<input checked="" type="checkbox"/>	JP10																																																																																											
1	2																																																																																												
<input checked="" type="checkbox"/>	<input checked="" type="checkbox"/>	JP14																																																																																											
<input type="checkbox"/>	<input type="checkbox"/>	JP15																																																																																											
<input type="checkbox"/>	<input type="checkbox"/>	JP16																																																																																											
<input checked="" type="checkbox"/>	<input checked="" type="checkbox"/>	JP17																																																																																											
<input type="checkbox"/>	<input type="checkbox"/>	JP18																																																																																											

CPU TYPE	JP1~6, JP9~10	JP14~JP18	CPU TYPE	JP1~6, JP9~10	JP14~JP18																																																																																								
Cyrix / IBM 6x86MX -PR200 (75MHz Bus)	75MHz x 2	V <sub>CORE</sub> = 2.9V	Cyrix / IBM 6x86MX -PR233 (66MHz Bus)	66MHz x 3	V <sub>CORE</sub> = 2.9V																																																																																								
	<table border="0"> <tr><td>1</td><td>2</td><td></td></tr> <tr><td><input checked="" type="checkbox"/></td><td><input checked="" type="checkbox"/></td><td>JP1</td></tr> <tr><td><input checked="" type="checkbox"/></td><td><input checked="" type="checkbox"/></td><td>JP2</td></tr> <tr><td><input type="checkbox"/></td><td><input type="checkbox"/></td><td>JP3</td></tr> <tr><td><input checked="" type="checkbox"/></td><td><input checked="" type="checkbox"/></td><td>JP4</td></tr> <tr><td><input type="checkbox"/></td><td><input type="checkbox"/></td><td>JP5</td></tr> <tr><td><input type="checkbox"/></td><td><input type="checkbox"/></td><td>JP6</td></tr> <tr><td><input type="checkbox"/></td><td><input type="checkbox"/></td><td>JP9</td></tr> <tr><td><input type="checkbox"/></td><td><input type="checkbox"/></td><td>JP10</td></tr> </table>	1		2		<input checked="" type="checkbox"/>	<input checked="" type="checkbox"/>	JP1	<input checked="" type="checkbox"/>	<input checked="" type="checkbox"/>	JP2	<input type="checkbox"/>	<input type="checkbox"/>	JP3	<input checked="" type="checkbox"/>	<input checked="" type="checkbox"/>	JP4	<input type="checkbox"/>	<input type="checkbox"/>	JP5	<input type="checkbox"/>	<input type="checkbox"/>	JP6	<input type="checkbox"/>	<input type="checkbox"/>	JP9	<input type="checkbox"/>	<input type="checkbox"/>	JP10	<table border="0"> <tr><td>1</td><td>2</td><td></td></tr> <tr><td><input checked="" type="checkbox"/></td><td><input checked="" type="checkbox"/></td><td>JP14</td></tr> <tr><td><input type="checkbox"/></td><td><input type="checkbox"/></td><td>JP15</td></tr> <tr><td><input type="checkbox"/></td><td><input type="checkbox"/></td><td>JP16</td></tr> <tr><td><input checked="" type="checkbox"/></td><td><input checked="" type="checkbox"/></td><td>JP17</td></tr> <tr><td><input type="checkbox"/></td><td><input type="checkbox"/></td><td>JP18</td></tr> </table>	1	2		<input checked="" type="checkbox"/>	<input checked="" type="checkbox"/>	JP14	<input type="checkbox"/>	<input type="checkbox"/>	JP15	<input type="checkbox"/>	<input type="checkbox"/>	JP16	<input checked="" type="checkbox"/>	<input checked="" type="checkbox"/>	JP17	<input type="checkbox"/>	<input type="checkbox"/>	JP18	<table border="0"> <tr><td>1</td><td>2</td><td></td></tr> <tr><td><input type="checkbox"/></td><td><input type="checkbox"/></td><td>JP1</td></tr> <tr><td><input checked="" type="checkbox"/></td><td><input checked="" type="checkbox"/></td><td>JP2</td></tr> <tr><td><input checked="" type="checkbox"/></td><td><input checked="" type="checkbox"/></td><td>JP3</td></tr> <tr><td><input type="checkbox"/></td><td><input type="checkbox"/></td><td>JP4</td></tr> <tr><td><input checked="" type="checkbox"/></td><td><input checked="" type="checkbox"/></td><td>JP5</td></tr> <tr><td><input type="checkbox"/></td><td><input type="checkbox"/></td><td>JP6</td></tr> <tr><td><input checked="" type="checkbox"/></td><td><input checked="" type="checkbox"/></td><td>JP9</td></tr> <tr><td><input checked="" type="checkbox"/></td><td><input checked="" type="checkbox"/></td><td>JP10</td></tr> </table>	1	2		<input type="checkbox"/>	<input type="checkbox"/>	JP1	<input checked="" type="checkbox"/>	<input checked="" type="checkbox"/>	JP2	<input checked="" type="checkbox"/>	<input checked="" type="checkbox"/>	JP3	<input type="checkbox"/>	<input type="checkbox"/>	JP4	<input checked="" type="checkbox"/>	<input checked="" type="checkbox"/>	JP5	<input type="checkbox"/>	<input type="checkbox"/>	JP6	<input checked="" type="checkbox"/>	<input checked="" type="checkbox"/>	JP9	<input checked="" type="checkbox"/>	<input checked="" type="checkbox"/>	JP10	<table border="0"> <tr><td>1</td><td>2</td><td></td></tr> <tr><td><input checked="" type="checkbox"/></td><td><input checked="" type="checkbox"/></td><td>JP14</td></tr> <tr><td><input type="checkbox"/></td><td><input type="checkbox"/></td><td>JP15</td></tr> <tr><td><input type="checkbox"/></td><td><input type="checkbox"/></td><td>JP16</td></tr> <tr><td><input checked="" type="checkbox"/></td><td><input checked="" type="checkbox"/></td><td>JP17</td></tr> <tr><td><input type="checkbox"/></td><td><input type="checkbox"/></td><td>JP18</td></tr> </table>	1	2		<input checked="" type="checkbox"/>	<input checked="" type="checkbox"/>	JP14	<input type="checkbox"/>	<input type="checkbox"/>	JP15	<input type="checkbox"/>	<input type="checkbox"/>	JP16	<input checked="" type="checkbox"/>	<input checked="" type="checkbox"/>	JP17	<input type="checkbox"/>
1	2																																																																																												
<input checked="" type="checkbox"/>	<input checked="" type="checkbox"/>	JP1																																																																																											
<input checked="" type="checkbox"/>	<input checked="" type="checkbox"/>	JP2																																																																																											
<input type="checkbox"/>	<input type="checkbox"/>	JP3																																																																																											
<input checked="" type="checkbox"/>	<input checked="" type="checkbox"/>	JP4																																																																																											
<input type="checkbox"/>	<input type="checkbox"/>	JP5																																																																																											
<input type="checkbox"/>	<input type="checkbox"/>	JP6																																																																																											
<input type="checkbox"/>	<input type="checkbox"/>	JP9																																																																																											
<input type="checkbox"/>	<input type="checkbox"/>	JP10																																																																																											
1	2																																																																																												
<input checked="" type="checkbox"/>	<input checked="" type="checkbox"/>	JP14																																																																																											
<input type="checkbox"/>	<input type="checkbox"/>	JP15																																																																																											
<input type="checkbox"/>	<input type="checkbox"/>	JP16																																																																																											
<input checked="" type="checkbox"/>	<input checked="" type="checkbox"/>	JP17																																																																																											
<input type="checkbox"/>	<input type="checkbox"/>	JP18																																																																																											
1	2																																																																																												
<input type="checkbox"/>	<input type="checkbox"/>	JP1																																																																																											
<input checked="" type="checkbox"/>	<input checked="" type="checkbox"/>	JP2																																																																																											
<input checked="" type="checkbox"/>	<input checked="" type="checkbox"/>	JP3																																																																																											
<input type="checkbox"/>	<input type="checkbox"/>	JP4																																																																																											
<input checked="" type="checkbox"/>	<input checked="" type="checkbox"/>	JP5																																																																																											
<input type="checkbox"/>	<input type="checkbox"/>	JP6																																																																																											
<input checked="" type="checkbox"/>	<input checked="" type="checkbox"/>	JP9																																																																																											
<input checked="" type="checkbox"/>	<input checked="" type="checkbox"/>	JP10																																																																																											
1	2																																																																																												
<input checked="" type="checkbox"/>	<input checked="" type="checkbox"/>	JP14																																																																																											
<input type="checkbox"/>	<input type="checkbox"/>	JP15																																																																																											
<input type="checkbox"/>	<input type="checkbox"/>	JP16																																																																																											
<input checked="" type="checkbox"/>	<input checked="" type="checkbox"/>	JP17																																																																																											
<input type="checkbox"/>	<input type="checkbox"/>	JP18																																																																																											
Cyrix / IBM 6x86MX -PR233 (75MHz Bus)	75MHz x 2.5	V <sub>CORE</sub> = 2.9V	Cyrix 6x86 MII -266 / IBM 6x86MX -PR266 (83MHz Bus)	83MHz x 2.5	V <sub>CORE</sub> = 2.9V																																																																																								
	<table border="0"> <tr><td>1</td><td>2</td><td></td></tr> <tr><td><input checked="" type="checkbox"/></td><td><input checked="" type="checkbox"/></td><td>JP1</td></tr> <tr><td><input checked="" type="checkbox"/></td><td><input checked="" type="checkbox"/></td><td>JP2</td></tr> <tr><td><input type="checkbox"/></td><td><input type="checkbox"/></td><td>JP3</td></tr> <tr><td><input checked="" type="checkbox"/></td><td><input checked="" type="checkbox"/></td><td>JP4</td></tr> <tr><td><input checked="" type="checkbox"/></td><td><input checked="" type="checkbox"/></td><td>JP5</td></tr> <tr><td><input type="checkbox"/></td><td><input type="checkbox"/></td><td>JP6</td></tr> <tr><td><input type="checkbox"/></td><td><input type="checkbox"/></td><td>JP9</td></tr> <tr><td><input type="checkbox"/></td><td><input type="checkbox"/></td><td>JP10</td></tr> </table>	1		2		<input checked="" type="checkbox"/>	<input checked="" type="checkbox"/>	JP1	<input checked="" type="checkbox"/>	<input checked="" type="checkbox"/>	JP2	<input type="checkbox"/>	<input type="checkbox"/>	JP3	<input checked="" type="checkbox"/>	<input checked="" type="checkbox"/>	JP4	<input checked="" type="checkbox"/>	<input checked="" type="checkbox"/>	JP5	<input type="checkbox"/>	<input type="checkbox"/>	JP6	<input type="checkbox"/>	<input type="checkbox"/>	JP9	<input type="checkbox"/>	<input type="checkbox"/>	JP10	<table border="0"> <tr><td>1</td><td>2</td><td></td></tr> <tr><td><input checked="" type="checkbox"/></td><td><input checked="" type="checkbox"/></td><td>JP14</td></tr> <tr><td><input type="checkbox"/></td><td><input type="checkbox"/></td><td>JP15</td></tr> <tr><td><input type="checkbox"/></td><td><input type="checkbox"/></td><td>JP16</td></tr> <tr><td><input checked="" type="checkbox"/></td><td><input checked="" type="checkbox"/></td><td>JP17</td></tr> <tr><td><input type="checkbox"/></td><td><input type="checkbox"/></td><td>JP18</td></tr> </table>	1	2		<input checked="" type="checkbox"/>	<input checked="" type="checkbox"/>	JP14	<input type="checkbox"/>	<input type="checkbox"/>	JP15	<input type="checkbox"/>	<input type="checkbox"/>	JP16	<input checked="" type="checkbox"/>	<input checked="" type="checkbox"/>	JP17	<input type="checkbox"/>	<input type="checkbox"/>	JP18	<table border="0"> <tr><td>1</td><td>2</td><td></td></tr> <tr><td><input type="checkbox"/></td><td><input type="checkbox"/></td><td>JP1</td></tr> <tr><td><input checked="" type="checkbox"/></td><td><input checked="" type="checkbox"/></td><td>JP2</td></tr> <tr><td><input type="checkbox"/></td><td><input type="checkbox"/></td><td>JP3</td></tr> <tr><td><input checked="" type="checkbox"/></td><td><input checked="" type="checkbox"/></td><td>JP4</td></tr> <tr><td><input checked="" type="checkbox"/></td><td><input checked="" type="checkbox"/></td><td>JP5</td></tr> <tr><td><input type="checkbox"/></td><td><input type="checkbox"/></td><td>JP6</td></tr> <tr><td><input type="checkbox"/></td><td><input type="checkbox"/></td><td>JP9</td></tr> <tr><td><input type="checkbox"/></td><td><input type="checkbox"/></td><td>JP10</td></tr> </table>	1	2		<input type="checkbox"/>	<input type="checkbox"/>	JP1	<input checked="" type="checkbox"/>	<input checked="" type="checkbox"/>	JP2	<input type="checkbox"/>	<input type="checkbox"/>	JP3	<input checked="" type="checkbox"/>	<input checked="" type="checkbox"/>	JP4	<input checked="" type="checkbox"/>	<input checked="" type="checkbox"/>	JP5	<input type="checkbox"/>	<input type="checkbox"/>	JP6	<input type="checkbox"/>	<input type="checkbox"/>	JP9	<input type="checkbox"/>	<input type="checkbox"/>	JP10	<table border="0"> <tr><td>1</td><td>2</td><td></td></tr> <tr><td><input checked="" type="checkbox"/></td><td><input checked="" type="checkbox"/></td><td>JP14</td></tr> <tr><td><input type="checkbox"/></td><td><input type="checkbox"/></td><td>JP15</td></tr> <tr><td><input type="checkbox"/></td><td><input type="checkbox"/></td><td>JP16</td></tr> <tr><td><input checked="" type="checkbox"/></td><td><input checked="" type="checkbox"/></td><td>JP17</td></tr> <tr><td><input type="checkbox"/></td><td><input type="checkbox"/></td><td>JP18</td></tr> </table>	1	2		<input checked="" type="checkbox"/>	<input checked="" type="checkbox"/>	JP14	<input type="checkbox"/>	<input type="checkbox"/>	JP15	<input type="checkbox"/>	<input type="checkbox"/>	JP16	<input checked="" type="checkbox"/>	<input checked="" type="checkbox"/>	JP17	<input type="checkbox"/>
1	2																																																																																												
<input checked="" type="checkbox"/>	<input checked="" type="checkbox"/>	JP1																																																																																											
<input checked="" type="checkbox"/>	<input checked="" type="checkbox"/>	JP2																																																																																											
<input type="checkbox"/>	<input type="checkbox"/>	JP3																																																																																											
<input checked="" type="checkbox"/>	<input checked="" type="checkbox"/>	JP4																																																																																											
<input checked="" type="checkbox"/>	<input checked="" type="checkbox"/>	JP5																																																																																											
<input type="checkbox"/>	<input type="checkbox"/>	JP6																																																																																											
<input type="checkbox"/>	<input type="checkbox"/>	JP9																																																																																											
<input type="checkbox"/>	<input type="checkbox"/>	JP10																																																																																											
1	2																																																																																												
<input checked="" type="checkbox"/>	<input checked="" type="checkbox"/>	JP14																																																																																											
<input type="checkbox"/>	<input type="checkbox"/>	JP15																																																																																											
<input type="checkbox"/>	<input type="checkbox"/>	JP16																																																																																											
<input checked="" type="checkbox"/>	<input checked="" type="checkbox"/>	JP17																																																																																											
<input type="checkbox"/>	<input type="checkbox"/>	JP18																																																																																											
1	2																																																																																												
<input type="checkbox"/>	<input type="checkbox"/>	JP1																																																																																											
<input checked="" type="checkbox"/>	<input checked="" type="checkbox"/>	JP2																																																																																											
<input type="checkbox"/>	<input type="checkbox"/>	JP3																																																																																											
<input checked="" type="checkbox"/>	<input checked="" type="checkbox"/>	JP4																																																																																											
<input checked="" type="checkbox"/>	<input checked="" type="checkbox"/>	JP5																																																																																											
<input type="checkbox"/>	<input type="checkbox"/>	JP6																																																																																											
<input type="checkbox"/>	<input type="checkbox"/>	JP9																																																																																											
<input type="checkbox"/>	<input type="checkbox"/>	JP10																																																																																											
1	2																																																																																												
<input checked="" type="checkbox"/>	<input checked="" type="checkbox"/>	JP14																																																																																											
<input type="checkbox"/>	<input type="checkbox"/>	JP15																																																																																											
<input type="checkbox"/>	<input type="checkbox"/>	JP16																																																																																											
<input checked="" type="checkbox"/>	<input checked="" type="checkbox"/>	JP17																																																																																											
<input type="checkbox"/>	<input type="checkbox"/>	JP18																																																																																											
Cyrix 6x86MII -300 / IBM 6x86MX -PR300 (66MHz Bus)	66MHz x 3.5	V <sub>CORE</sub> = 2.9V	Cyrix 6x86MII -300 / IBM 6x86MX -PR300 (75MHz Bus)	75MHz x 3	V <sub>CORE</sub> = 2.9V																																																																																								
	<table border="0"> <tr><td>1</td><td>2</td><td></td></tr> <tr><td><input type="checkbox"/></td><td><input type="checkbox"/></td><td>JP1</td></tr> <tr><td><input checked="" type="checkbox"/></td><td><input checked="" type="checkbox"/></td><td>JP2</td></tr> <tr><td><input checked="" type="checkbox"/></td><td><input checked="" type="checkbox"/></td><td>JP3</td></tr> <tr><td><input type="checkbox"/></td><td><input type="checkbox"/></td><td>JP4</td></tr> <tr><td><input type="checkbox"/></td><td><input type="checkbox"/></td><td>JP5</td></tr> <tr><td><input type="checkbox"/></td><td><input type="checkbox"/></td><td>JP6</td></tr> <tr><td><input checked="" type="checkbox"/></td><td><input checked="" type="checkbox"/></td><td>JP9</td></tr> <tr><td><input checked="" type="checkbox"/></td><td><input checked="" type="checkbox"/></td><td>JP10</td></tr> </table>	1		2		<input type="checkbox"/>	<input type="checkbox"/>	JP1	<input checked="" type="checkbox"/>	<input checked="" type="checkbox"/>	JP2	<input checked="" type="checkbox"/>	<input checked="" type="checkbox"/>	JP3	<input type="checkbox"/>	<input type="checkbox"/>	JP4	<input type="checkbox"/>	<input type="checkbox"/>	JP5	<input type="checkbox"/>	<input type="checkbox"/>	JP6	<input checked="" type="checkbox"/>	<input checked="" type="checkbox"/>	JP9	<input checked="" type="checkbox"/>	<input checked="" type="checkbox"/>	JP10	<table border="0"> <tr><td>1</td><td>2</td><td></td></tr> <tr><td><input checked="" type="checkbox"/></td><td><input checked="" type="checkbox"/></td><td>JP14</td></tr> <tr><td><input type="checkbox"/></td><td><input type="checkbox"/></td><td>JP15</td></tr> <tr><td><input type="checkbox"/></td><td><input type="checkbox"/></td><td>JP16</td></tr> <tr><td><input checked="" type="checkbox"/></td><td><input checked="" type="checkbox"/></td><td>JP17</td></tr> <tr><td><input type="checkbox"/></td><td><input type="checkbox"/></td><td>JP18</td></tr> </table>	1	2		<input checked="" type="checkbox"/>	<input checked="" type="checkbox"/>	JP14	<input type="checkbox"/>	<input type="checkbox"/>	JP15	<input type="checkbox"/>	<input type="checkbox"/>	JP16	<input checked="" type="checkbox"/>	<input checked="" type="checkbox"/>	JP17	<input type="checkbox"/>	<input type="checkbox"/>	JP18	<table border="0"> <tr><td>1</td><td>2</td><td></td></tr> <tr><td><input checked="" type="checkbox"/></td><td><input checked="" type="checkbox"/></td><td>JP1</td></tr> <tr><td><input checked="" type="checkbox"/></td><td><input checked="" type="checkbox"/></td><td>JP2</td></tr> <tr><td><input type="checkbox"/></td><td><input type="checkbox"/></td><td>JP3</td></tr> <tr><td><input type="checkbox"/></td><td><input type="checkbox"/></td><td>JP4</td></tr> <tr><td><input checked="" type="checkbox"/></td><td><input checked="" type="checkbox"/></td><td>JP5</td></tr> <tr><td><input type="checkbox"/></td><td><input type="checkbox"/></td><td>JP6</td></tr> <tr><td><input type="checkbox"/></td><td><input type="checkbox"/></td><td>JP9</td></tr> <tr><td><input type="checkbox"/></td><td><input type="checkbox"/></td><td>JP10</td></tr> </table>	1	2		<input checked="" type="checkbox"/>	<input checked="" type="checkbox"/>	JP1	<input checked="" type="checkbox"/>	<input checked="" type="checkbox"/>	JP2	<input type="checkbox"/>	<input type="checkbox"/>	JP3	<input type="checkbox"/>	<input type="checkbox"/>	JP4	<input checked="" type="checkbox"/>	<input checked="" type="checkbox"/>	JP5	<input type="checkbox"/>	<input type="checkbox"/>	JP6	<input type="checkbox"/>	<input type="checkbox"/>	JP9	<input type="checkbox"/>	<input type="checkbox"/>	JP10	<table border="0"> <tr><td>1</td><td>2</td><td></td></tr> <tr><td><input checked="" type="checkbox"/></td><td><input checked="" type="checkbox"/></td><td>JP14</td></tr> <tr><td><input type="checkbox"/></td><td><input type="checkbox"/></td><td>JP15</td></tr> <tr><td><input type="checkbox"/></td><td><input type="checkbox"/></td><td>JP16</td></tr> <tr><td><input checked="" type="checkbox"/></td><td><input checked="" type="checkbox"/></td><td>JP17</td></tr> <tr><td><input type="checkbox"/></td><td><input type="checkbox"/></td><td>JP18</td></tr> </table>	1	2		<input checked="" type="checkbox"/>	<input checked="" type="checkbox"/>	JP14	<input type="checkbox"/>	<input type="checkbox"/>	JP15	<input type="checkbox"/>	<input type="checkbox"/>	JP16	<input checked="" type="checkbox"/>	<input checked="" type="checkbox"/>	JP17	<input type="checkbox"/>
1	2																																																																																												
<input type="checkbox"/>	<input type="checkbox"/>	JP1																																																																																											
<input checked="" type="checkbox"/>	<input checked="" type="checkbox"/>	JP2																																																																																											
<input checked="" type="checkbox"/>	<input checked="" type="checkbox"/>	JP3																																																																																											
<input type="checkbox"/>	<input type="checkbox"/>	JP4																																																																																											
<input type="checkbox"/>	<input type="checkbox"/>	JP5																																																																																											
<input type="checkbox"/>	<input type="checkbox"/>	JP6																																																																																											
<input checked="" type="checkbox"/>	<input checked="" type="checkbox"/>	JP9																																																																																											
<input checked="" type="checkbox"/>	<input checked="" type="checkbox"/>	JP10																																																																																											
1	2																																																																																												
<input checked="" type="checkbox"/>	<input checked="" type="checkbox"/>	JP14																																																																																											
<input type="checkbox"/>	<input type="checkbox"/>	JP15																																																																																											
<input type="checkbox"/>	<input type="checkbox"/>	JP16																																																																																											
<input checked="" type="checkbox"/>	<input checked="" type="checkbox"/>	JP17																																																																																											
<input type="checkbox"/>	<input type="checkbox"/>	JP18																																																																																											
1	2																																																																																												
<input checked="" type="checkbox"/>	<input checked="" type="checkbox"/>	JP1																																																																																											
<input checked="" type="checkbox"/>	<input checked="" type="checkbox"/>	JP2																																																																																											
<input type="checkbox"/>	<input type="checkbox"/>	JP3																																																																																											
<input type="checkbox"/>	<input type="checkbox"/>	JP4																																																																																											
<input checked="" type="checkbox"/>	<input checked="" type="checkbox"/>	JP5																																																																																											
<input type="checkbox"/>	<input type="checkbox"/>	JP6																																																																																											
<input type="checkbox"/>	<input type="checkbox"/>	JP9																																																																																											
<input type="checkbox"/>	<input type="checkbox"/>	JP10																																																																																											
1	2																																																																																												
<input checked="" type="checkbox"/>	<input checked="" type="checkbox"/>	JP14																																																																																											
<input type="checkbox"/>	<input type="checkbox"/>	JP15																																																																																											
<input type="checkbox"/>	<input type="checkbox"/>	JP16																																																																																											
<input checked="" type="checkbox"/>	<input checked="" type="checkbox"/>	JP17																																																																																											
<input type="checkbox"/>	<input type="checkbox"/>	JP18																																																																																											

Note: Please select the correct FSB clock when using Cyrix and IDT CPU. Wrong setting may cause problem to the PC system

**MVP3 SYSTEM BOARD**

**HARDWARE SETUP**

CPU TYPE	JP1~6, JP9~10	JP14~JP18	CPU TYPE	JP1~6, JP9~10	JP14~JP18
Cyrux 6x86MII -333 / IBM 6x86MX -PR333	83MHz x 3	V <sub>CORE</sub> = 2.9V	Cyrux 6x86MII -366 / IBM 6x86MX -PR366	100MHz x 2.5	V <sub>CORE</sub> = 2.9V
	1 2	1 2		1 2	1 2
	<input type="checkbox"/> <input type="checkbox"/> JP1	<input checked="" type="checkbox"/> <input checked="" type="checkbox"/> JP14		<input type="checkbox"/> <input type="checkbox"/> JP1	<input checked="" type="checkbox"/> <input checked="" type="checkbox"/> JP14
	<input checked="" type="checkbox"/> <input checked="" type="checkbox"/> JP2	<input type="checkbox"/> <input type="checkbox"/> JP15		<input type="checkbox"/> <input type="checkbox"/> JP2	<input type="checkbox"/> <input type="checkbox"/> JP15
	<input type="checkbox"/> <input type="checkbox"/> JP3	<input type="checkbox"/> <input type="checkbox"/> JP16		<input type="checkbox"/> <input type="checkbox"/> JP3	<input type="checkbox"/> <input type="checkbox"/> JP16
	<input type="checkbox"/> <input type="checkbox"/> JP4	<input checked="" type="checkbox"/> <input checked="" type="checkbox"/> JP17		<input checked="" type="checkbox"/> <input checked="" type="checkbox"/> JP4	<input checked="" type="checkbox"/> <input checked="" type="checkbox"/> JP17
	<input checked="" type="checkbox"/> <input checked="" type="checkbox"/> JP5	<input type="checkbox"/> <input type="checkbox"/> JP18		<input checked="" type="checkbox"/> <input checked="" type="checkbox"/> JP5	<input type="checkbox"/> <input type="checkbox"/> JP18
	<input type="checkbox"/> <input type="checkbox"/> JP6			<input type="checkbox"/> <input type="checkbox"/> JP6	
<input type="checkbox"/> <input type="checkbox"/> JP9		<input type="checkbox"/> <input type="checkbox"/> JP9			
<input type="checkbox"/> <input type="checkbox"/> JP10		<input checked="" type="checkbox"/> <input checked="" type="checkbox"/> JP10			

CPU TYPE	JP1~6, JP9~10	JP14~JP18	CPU TYPE	JP1~6, JP9~10	JP14~JP18
Intel 80502 -90	60MHz x 1.5	V <sub>CORE</sub> = 3.3V	Intel 80502 -100	66MHz x 1.5	V <sub>CORE</sub> = 3.3V
	1 2	1 2		1 2	1 2
	<input checked="" type="checkbox"/> <input checked="" type="checkbox"/> JP1	<input checked="" type="checkbox"/> <input checked="" type="checkbox"/> JP14		<input type="checkbox"/> <input type="checkbox"/> JP1	<input checked="" type="checkbox"/> <input checked="" type="checkbox"/> JP14
	<input checked="" type="checkbox"/> <input checked="" type="checkbox"/> JP2	<input type="checkbox"/> <input type="checkbox"/> JP15		<input checked="" type="checkbox"/> <input checked="" type="checkbox"/> JP2	<input type="checkbox"/> <input type="checkbox"/> JP15
	<input checked="" type="checkbox"/> <input checked="" type="checkbox"/> JP3	<input checked="" type="checkbox"/> <input checked="" type="checkbox"/> JP16		<input checked="" type="checkbox"/> <input checked="" type="checkbox"/> JP3	<input checked="" type="checkbox"/> <input checked="" type="checkbox"/> JP16
	<input type="checkbox"/> <input type="checkbox"/> JP4	<input checked="" type="checkbox"/> <input checked="" type="checkbox"/> JP17		<input type="checkbox"/> <input type="checkbox"/> JP4	<input checked="" type="checkbox"/> <input checked="" type="checkbox"/> JP17
	<input type="checkbox"/> <input type="checkbox"/> JP5	<input type="checkbox"/> <input type="checkbox"/> JP18		<input type="checkbox"/> <input type="checkbox"/> JP5	<input type="checkbox"/> <input type="checkbox"/> JP18
	<input type="checkbox"/> <input type="checkbox"/> JP6			<input type="checkbox"/> <input type="checkbox"/> JP6	
<input checked="" type="checkbox"/> <input checked="" type="checkbox"/> JP9		<input checked="" type="checkbox"/> <input checked="" type="checkbox"/> JP9			
<input checked="" type="checkbox"/> <input checked="" type="checkbox"/> JP10		<input checked="" type="checkbox"/> <input checked="" type="checkbox"/> JP10			

CPU TYPE	JP1~6, JP9~10	JP14~JP18	CPU TYPE	JP1~6, JP9~10	JP14~JP18
Intel 80502 -120	60MHz x 2	V <sub>CORE</sub> = 3.3V	Intel 80502 -133	66MHz x 2	V <sub>CORE</sub> = 3.3V
	1 2	1 2		1 2	1 2
	<input checked="" type="checkbox"/> <input checked="" type="checkbox"/> JP1	<input checked="" type="checkbox"/> <input checked="" type="checkbox"/> JP14		<input type="checkbox"/> <input type="checkbox"/> JP1	<input checked="" type="checkbox"/> <input checked="" type="checkbox"/> JP14
	<input checked="" type="checkbox"/> <input checked="" type="checkbox"/> JP2	<input type="checkbox"/> <input type="checkbox"/> JP15		<input checked="" type="checkbox"/> <input checked="" type="checkbox"/> JP2	<input type="checkbox"/> <input type="checkbox"/> JP15
	<input checked="" type="checkbox"/> <input checked="" type="checkbox"/> JP3	<input checked="" type="checkbox"/> <input checked="" type="checkbox"/> JP16		<input checked="" type="checkbox"/> <input checked="" type="checkbox"/> JP3	<input checked="" type="checkbox"/> <input checked="" type="checkbox"/> JP16
	<input checked="" type="checkbox"/> <input checked="" type="checkbox"/> JP4	<input checked="" type="checkbox"/> <input checked="" type="checkbox"/> JP17		<input checked="" type="checkbox"/> <input checked="" type="checkbox"/> JP4	<input checked="" type="checkbox"/> <input checked="" type="checkbox"/> JP17
	<input type="checkbox"/> <input type="checkbox"/> JP5	<input type="checkbox"/> <input type="checkbox"/> JP18		<input type="checkbox"/> <input type="checkbox"/> JP5	<input type="checkbox"/> <input type="checkbox"/> JP18
	<input type="checkbox"/> <input type="checkbox"/> JP6			<input type="checkbox"/> <input type="checkbox"/> JP6	
<input checked="" type="checkbox"/> <input checked="" type="checkbox"/> JP9		<input checked="" type="checkbox"/> <input checked="" type="checkbox"/> JP9			
<input checked="" type="checkbox"/> <input checked="" type="checkbox"/> JP10		<input checked="" type="checkbox"/> <input checked="" type="checkbox"/> JP10			

CPU TYPE	JP1~6, JP9~10	JP14~JP18	CPU TYPE	JP1~6, JP9~10	JP14~JP18
----------	---------------	-----------	----------	---------------	-----------

**MVP3 SYSTEM BOARD**

**HARDWARE SETUP**

	60MHz x 2.5	V <sub>CORE</sub> = 3.3V		66MHz x 2.5	V <sub>CORE</sub> = 3.3V																																																																
Intel 80502 -150	<table border="1"> <tr><td>1</td><td>2</td></tr> <tr><td><input checked="" type="checkbox"/></td><td><input checked="" type="checkbox"/></td></tr> <tr><td><input checked="" type="checkbox"/></td><td><input checked="" type="checkbox"/></td></tr> <tr><td><input checked="" type="checkbox"/></td><td><input checked="" type="checkbox"/></td></tr> <tr><td><input checked="" type="checkbox"/></td><td><input checked="" type="checkbox"/></td></tr> <tr><td><input checked="" type="checkbox"/></td><td><input checked="" type="checkbox"/></td></tr> <tr><td><input type="checkbox"/></td><td><input type="checkbox"/></td></tr> <tr><td><input checked="" type="checkbox"/></td><td><input checked="" type="checkbox"/></td></tr> <tr><td><input checked="" type="checkbox"/></td><td><input checked="" type="checkbox"/></td></tr> </table>	1	2	<input checked="" type="checkbox"/>	<input checked="" type="checkbox"/>	<input checked="" type="checkbox"/>	<input checked="" type="checkbox"/>	<input checked="" type="checkbox"/>	<input checked="" type="checkbox"/>	<input checked="" type="checkbox"/>	<input checked="" type="checkbox"/>	<input checked="" type="checkbox"/>	<input checked="" type="checkbox"/>	<input type="checkbox"/>	<input type="checkbox"/>	<input checked="" type="checkbox"/>	<input checked="" type="checkbox"/>	<input checked="" type="checkbox"/>	<input checked="" type="checkbox"/>	<table border="1"> <tr><td>1</td><td>2</td></tr> <tr><td><input checked="" type="checkbox"/></td><td><input checked="" type="checkbox"/></td></tr> <tr><td><input type="checkbox"/></td><td><input type="checkbox"/></td></tr> <tr><td><input checked="" type="checkbox"/></td><td><input checked="" type="checkbox"/></td></tr> <tr><td><input checked="" type="checkbox"/></td><td><input checked="" type="checkbox"/></td></tr> <tr><td><input type="checkbox"/></td><td><input type="checkbox"/></td></tr> </table>	1	2	<input checked="" type="checkbox"/>	<input checked="" type="checkbox"/>	<input type="checkbox"/>	<input type="checkbox"/>	<input checked="" type="checkbox"/>	<input checked="" type="checkbox"/>	<input checked="" type="checkbox"/>	<input checked="" type="checkbox"/>	<input type="checkbox"/>	<input type="checkbox"/>	Intel 80502 -166	<table border="1"> <tr><td>1</td><td>2</td></tr> <tr><td><input type="checkbox"/></td><td><input type="checkbox"/></td></tr> <tr><td><input checked="" type="checkbox"/></td><td><input checked="" type="checkbox"/></td></tr> <tr><td><input checked="" type="checkbox"/></td><td><input checked="" type="checkbox"/></td></tr> <tr><td><input checked="" type="checkbox"/></td><td><input checked="" type="checkbox"/></td></tr> <tr><td><input checked="" type="checkbox"/></td><td><input checked="" type="checkbox"/></td></tr> <tr><td><input checked="" type="checkbox"/></td><td><input checked="" type="checkbox"/></td></tr> <tr><td><input type="checkbox"/></td><td><input type="checkbox"/></td></tr> <tr><td><input checked="" type="checkbox"/></td><td><input checked="" type="checkbox"/></td></tr> <tr><td><input checked="" type="checkbox"/></td><td><input checked="" type="checkbox"/></td></tr> </table>	1	2	<input type="checkbox"/>	<input type="checkbox"/>	<input checked="" type="checkbox"/>	<input checked="" type="checkbox"/>	<input checked="" type="checkbox"/>	<input checked="" type="checkbox"/>	<input checked="" type="checkbox"/>	<input checked="" type="checkbox"/>	<input checked="" type="checkbox"/>	<input checked="" type="checkbox"/>	<input checked="" type="checkbox"/>	<input checked="" type="checkbox"/>	<input type="checkbox"/>	<input type="checkbox"/>	<input checked="" type="checkbox"/>	<input checked="" type="checkbox"/>	<input checked="" type="checkbox"/>	<input checked="" type="checkbox"/>	<table border="1"> <tr><td>1</td><td>2</td></tr> <tr><td><input checked="" type="checkbox"/></td><td><input checked="" type="checkbox"/></td></tr> <tr><td><input type="checkbox"/></td><td><input type="checkbox"/></td></tr> <tr><td><input checked="" type="checkbox"/></td><td><input checked="" type="checkbox"/></td></tr> <tr><td><input checked="" type="checkbox"/></td><td><input checked="" type="checkbox"/></td></tr> <tr><td><input checked="" type="checkbox"/></td><td><input checked="" type="checkbox"/></td></tr> <tr><td><input type="checkbox"/></td><td><input type="checkbox"/></td></tr> </table>	1	2	<input checked="" type="checkbox"/>	<input checked="" type="checkbox"/>	<input type="checkbox"/>	<input type="checkbox"/>	<input checked="" type="checkbox"/>	<input checked="" type="checkbox"/>	<input checked="" type="checkbox"/>	<input checked="" type="checkbox"/>	<input checked="" type="checkbox"/>	<input checked="" type="checkbox"/>	<input type="checkbox"/>	<input type="checkbox"/>
1	2																																																																				
<input checked="" type="checkbox"/>	<input checked="" type="checkbox"/>																																																																				
<input checked="" type="checkbox"/>	<input checked="" type="checkbox"/>																																																																				
<input checked="" type="checkbox"/>	<input checked="" type="checkbox"/>																																																																				
<input checked="" type="checkbox"/>	<input checked="" type="checkbox"/>																																																																				
<input checked="" type="checkbox"/>	<input checked="" type="checkbox"/>																																																																				
<input type="checkbox"/>	<input type="checkbox"/>																																																																				
<input checked="" type="checkbox"/>	<input checked="" type="checkbox"/>																																																																				
<input checked="" type="checkbox"/>	<input checked="" type="checkbox"/>																																																																				
1	2																																																																				
<input checked="" type="checkbox"/>	<input checked="" type="checkbox"/>																																																																				
<input type="checkbox"/>	<input type="checkbox"/>																																																																				
<input checked="" type="checkbox"/>	<input checked="" type="checkbox"/>																																																																				
<input checked="" type="checkbox"/>	<input checked="" type="checkbox"/>																																																																				
<input type="checkbox"/>	<input type="checkbox"/>																																																																				
1	2																																																																				
<input type="checkbox"/>	<input type="checkbox"/>																																																																				
<input checked="" type="checkbox"/>	<input checked="" type="checkbox"/>																																																																				
<input checked="" type="checkbox"/>	<input checked="" type="checkbox"/>																																																																				
<input checked="" type="checkbox"/>	<input checked="" type="checkbox"/>																																																																				
<input checked="" type="checkbox"/>	<input checked="" type="checkbox"/>																																																																				
<input checked="" type="checkbox"/>	<input checked="" type="checkbox"/>																																																																				
<input type="checkbox"/>	<input type="checkbox"/>																																																																				
<input checked="" type="checkbox"/>	<input checked="" type="checkbox"/>																																																																				
<input checked="" type="checkbox"/>	<input checked="" type="checkbox"/>																																																																				
1	2																																																																				
<input checked="" type="checkbox"/>	<input checked="" type="checkbox"/>																																																																				
<input type="checkbox"/>	<input type="checkbox"/>																																																																				
<input checked="" type="checkbox"/>	<input checked="" type="checkbox"/>																																																																				
<input checked="" type="checkbox"/>	<input checked="" type="checkbox"/>																																																																				
<input checked="" type="checkbox"/>	<input checked="" type="checkbox"/>																																																																				
<input type="checkbox"/>	<input type="checkbox"/>																																																																				

CPU TYPE	JP1~6, JP9~10	JP14~JP18	CPU TYPE	JP1~6, JP9~10	JP14~JP18																																																														
	66MHz x 3	V <sub>CORE</sub> = 3.3V		66MHz x 2.5	V <sub>CORE</sub> = 2.8V																																																														
Intel 80502 -200	<table border="1"> <tr><td>1</td><td>2</td></tr> <tr><td><input type="checkbox"/></td><td><input type="checkbox"/></td></tr> <tr><td><input checked="" type="checkbox"/></td><td><input checked="" type="checkbox"/></td></tr> <tr><td><input checked="" type="checkbox"/></td><td><input checked="" type="checkbox"/></td></tr> <tr><td><input type="checkbox"/></td><td><input type="checkbox"/></td></tr> <tr><td><input checked="" type="checkbox"/></td><td><input checked="" type="checkbox"/></td></tr> <tr><td><input type="checkbox"/></td><td><input type="checkbox"/></td></tr> <tr><td><input checked="" type="checkbox"/></td><td><input checked="" type="checkbox"/></td></tr> <tr><td><input checked="" type="checkbox"/></td><td><input checked="" type="checkbox"/></td></tr> </table>	1	2	<input type="checkbox"/>	<input type="checkbox"/>	<input checked="" type="checkbox"/>	<input checked="" type="checkbox"/>	<input checked="" type="checkbox"/>	<input checked="" type="checkbox"/>	<input type="checkbox"/>	<input type="checkbox"/>	<input checked="" type="checkbox"/>	<input checked="" type="checkbox"/>	<input type="checkbox"/>	<input type="checkbox"/>	<input checked="" type="checkbox"/>	<input checked="" type="checkbox"/>	<input checked="" type="checkbox"/>	<input checked="" type="checkbox"/>	<table border="1"> <tr><td>1</td><td>2</td></tr> <tr><td><input checked="" type="checkbox"/></td><td><input checked="" type="checkbox"/></td></tr> <tr><td><input type="checkbox"/></td><td><input type="checkbox"/></td></tr> <tr><td><input checked="" type="checkbox"/></td><td><input checked="" type="checkbox"/></td></tr> <tr><td><input checked="" type="checkbox"/></td><td><input checked="" type="checkbox"/></td></tr> <tr><td><input type="checkbox"/></td><td><input type="checkbox"/></td></tr> </table>	1	2	<input checked="" type="checkbox"/>	<input checked="" type="checkbox"/>	<input type="checkbox"/>	<input type="checkbox"/>	<input checked="" type="checkbox"/>	<input checked="" type="checkbox"/>	<input checked="" type="checkbox"/>	<input checked="" type="checkbox"/>	<input type="checkbox"/>	<input type="checkbox"/>	Intel 80503 -166	<table border="1"> <tr><td>1</td><td>2</td></tr> <tr><td><input type="checkbox"/></td><td><input type="checkbox"/></td></tr> <tr><td><input checked="" type="checkbox"/></td><td><input checked="" type="checkbox"/></td></tr> <tr><td><input checked="" type="checkbox"/></td><td><input checked="" type="checkbox"/></td></tr> <tr><td><input checked="" type="checkbox"/></td><td><input checked="" type="checkbox"/></td></tr> <tr><td><input checked="" type="checkbox"/></td><td><input checked="" type="checkbox"/></td></tr> <tr><td><input checked="" type="checkbox"/></td><td><input checked="" type="checkbox"/></td></tr> <tr><td><input type="checkbox"/></td><td><input type="checkbox"/></td></tr> <tr><td><input checked="" type="checkbox"/></td><td><input checked="" type="checkbox"/></td></tr> <tr><td><input checked="" type="checkbox"/></td><td><input checked="" type="checkbox"/></td></tr> </table>	1	2	<input type="checkbox"/>	<input type="checkbox"/>	<input checked="" type="checkbox"/>	<input checked="" type="checkbox"/>	<input checked="" type="checkbox"/>	<input checked="" type="checkbox"/>	<input checked="" type="checkbox"/>	<input checked="" type="checkbox"/>	<input checked="" type="checkbox"/>	<input checked="" type="checkbox"/>	<input checked="" type="checkbox"/>	<input checked="" type="checkbox"/>	<input type="checkbox"/>	<input type="checkbox"/>	<input checked="" type="checkbox"/>	<input checked="" type="checkbox"/>	<input checked="" type="checkbox"/>	<input checked="" type="checkbox"/>	<table border="1"> <tr><td>1</td><td>2</td></tr> <tr><td><input type="checkbox"/></td><td><input type="checkbox"/></td></tr> <tr><td><input type="checkbox"/></td><td><input type="checkbox"/></td></tr> <tr><td><input type="checkbox"/></td><td><input type="checkbox"/></td></tr> <tr><td><input checked="" type="checkbox"/></td><td><input checked="" type="checkbox"/></td></tr> <tr><td><input type="checkbox"/></td><td><input type="checkbox"/></td></tr> </table>	1	2	<input type="checkbox"/>	<input type="checkbox"/>	<input type="checkbox"/>	<input type="checkbox"/>	<input type="checkbox"/>	<input type="checkbox"/>	<input checked="" type="checkbox"/>	<input checked="" type="checkbox"/>	<input type="checkbox"/>	<input type="checkbox"/>
1	2																																																																		
<input type="checkbox"/>	<input type="checkbox"/>																																																																		
<input checked="" type="checkbox"/>	<input checked="" type="checkbox"/>																																																																		
<input checked="" type="checkbox"/>	<input checked="" type="checkbox"/>																																																																		
<input type="checkbox"/>	<input type="checkbox"/>																																																																		
<input checked="" type="checkbox"/>	<input checked="" type="checkbox"/>																																																																		
<input type="checkbox"/>	<input type="checkbox"/>																																																																		
<input checked="" type="checkbox"/>	<input checked="" type="checkbox"/>																																																																		
<input checked="" type="checkbox"/>	<input checked="" type="checkbox"/>																																																																		
1	2																																																																		
<input checked="" type="checkbox"/>	<input checked="" type="checkbox"/>																																																																		
<input type="checkbox"/>	<input type="checkbox"/>																																																																		
<input checked="" type="checkbox"/>	<input checked="" type="checkbox"/>																																																																		
<input checked="" type="checkbox"/>	<input checked="" type="checkbox"/>																																																																		
<input type="checkbox"/>	<input type="checkbox"/>																																																																		
1	2																																																																		
<input type="checkbox"/>	<input type="checkbox"/>																																																																		
<input checked="" type="checkbox"/>	<input checked="" type="checkbox"/>																																																																		
<input checked="" type="checkbox"/>	<input checked="" type="checkbox"/>																																																																		
<input checked="" type="checkbox"/>	<input checked="" type="checkbox"/>																																																																		
<input checked="" type="checkbox"/>	<input checked="" type="checkbox"/>																																																																		
<input checked="" type="checkbox"/>	<input checked="" type="checkbox"/>																																																																		
<input type="checkbox"/>	<input type="checkbox"/>																																																																		
<input checked="" type="checkbox"/>	<input checked="" type="checkbox"/>																																																																		
<input checked="" type="checkbox"/>	<input checked="" type="checkbox"/>																																																																		
1	2																																																																		
<input type="checkbox"/>	<input type="checkbox"/>																																																																		
<input type="checkbox"/>	<input type="checkbox"/>																																																																		
<input type="checkbox"/>	<input type="checkbox"/>																																																																		
<input checked="" type="checkbox"/>	<input checked="" type="checkbox"/>																																																																		
<input type="checkbox"/>	<input type="checkbox"/>																																																																		

CPU TYPE	JP1~6, JP9~10	JP14~JP18	CPU TYPE	JP1~6, JP9~10	JP14~JP18																																																												
	66MHz x 3	V <sub>CORE</sub> = 2.8V		66MHz x 3.5	V <sub>CORE</sub> = 2.8V																																																												
Intel 80503 -200	<table border="1"> <tr><td>1</td><td>2</td></tr> <tr><td><input type="checkbox"/></td><td><input type="checkbox"/></td></tr> <tr><td><input checked="" type="checkbox"/></td><td><input checked="" type="checkbox"/></td></tr> <tr><td><input checked="" type="checkbox"/></td><td><input checked="" type="checkbox"/></td></tr> <tr><td><input type="checkbox"/></td><td><input type="checkbox"/></td></tr> <tr><td><input checked="" type="checkbox"/></td><td><input checked="" type="checkbox"/></td></tr> <tr><td><input type="checkbox"/></td><td><input type="checkbox"/></td></tr> <tr><td><input checked="" type="checkbox"/></td><td><input checked="" type="checkbox"/></td></tr> <tr><td><input checked="" type="checkbox"/></td><td><input checked="" type="checkbox"/></td></tr> </table>	1	2	<input type="checkbox"/>	<input type="checkbox"/>	<input checked="" type="checkbox"/>	<input checked="" type="checkbox"/>	<input checked="" type="checkbox"/>	<input checked="" type="checkbox"/>	<input type="checkbox"/>	<input type="checkbox"/>	<input checked="" type="checkbox"/>	<input checked="" type="checkbox"/>	<input type="checkbox"/>	<input type="checkbox"/>	<input checked="" type="checkbox"/>	<input checked="" type="checkbox"/>	<input checked="" type="checkbox"/>	<input checked="" type="checkbox"/>	<table border="1"> <tr><td>1</td><td>2</td></tr> <tr><td><input type="checkbox"/></td><td><input type="checkbox"/></td></tr> <tr><td><input type="checkbox"/></td><td><input type="checkbox"/></td></tr> <tr><td><input type="checkbox"/></td><td><input type="checkbox"/></td></tr> <tr><td><input checked="" type="checkbox"/></td><td><input checked="" type="checkbox"/></td></tr> <tr><td><input type="checkbox"/></td><td><input type="checkbox"/></td></tr> </table>	1	2	<input type="checkbox"/>	<input type="checkbox"/>	<input type="checkbox"/>	<input type="checkbox"/>	<input type="checkbox"/>	<input type="checkbox"/>	<input checked="" type="checkbox"/>	<input checked="" type="checkbox"/>	<input type="checkbox"/>	<input type="checkbox"/>	Intel 80503 -233	<table border="1"> <tr><td>1</td><td>2</td></tr> <tr><td><input type="checkbox"/></td><td><input type="checkbox"/></td></tr> <tr><td><input checked="" type="checkbox"/></td><td><input checked="" type="checkbox"/></td></tr> <tr><td><input checked="" type="checkbox"/></td><td><input checked="" type="checkbox"/></td></tr> <tr><td><input type="checkbox"/></td><td><input type="checkbox"/></td></tr> <tr><td><input type="checkbox"/></td><td><input type="checkbox"/></td></tr> <tr><td><input type="checkbox"/></td><td><input type="checkbox"/></td></tr> <tr><td><input checked="" type="checkbox"/></td><td><input checked="" type="checkbox"/></td></tr> <tr><td><input checked="" type="checkbox"/></td><td><input checked="" type="checkbox"/></td></tr> </table>	1	2	<input type="checkbox"/>	<input type="checkbox"/>	<input checked="" type="checkbox"/>	<input checked="" type="checkbox"/>	<input checked="" type="checkbox"/>	<input checked="" type="checkbox"/>	<input type="checkbox"/>	<input type="checkbox"/>	<input type="checkbox"/>	<input type="checkbox"/>	<input type="checkbox"/>	<input type="checkbox"/>	<input checked="" type="checkbox"/>	<input checked="" type="checkbox"/>	<input checked="" type="checkbox"/>	<input checked="" type="checkbox"/>	<table border="1"> <tr><td>1</td><td>2</td></tr> <tr><td><input type="checkbox"/></td><td><input type="checkbox"/></td></tr> <tr><td><input type="checkbox"/></td><td><input type="checkbox"/></td></tr> <tr><td><input type="checkbox"/></td><td><input type="checkbox"/></td></tr> <tr><td><input checked="" type="checkbox"/></td><td><input checked="" type="checkbox"/></td></tr> <tr><td><input type="checkbox"/></td><td><input type="checkbox"/></td></tr> </table>	1	2	<input type="checkbox"/>	<input type="checkbox"/>	<input type="checkbox"/>	<input type="checkbox"/>	<input type="checkbox"/>	<input type="checkbox"/>	<input checked="" type="checkbox"/>	<input checked="" type="checkbox"/>	<input type="checkbox"/>	<input type="checkbox"/>
1	2																																																																
<input type="checkbox"/>	<input type="checkbox"/>																																																																
<input checked="" type="checkbox"/>	<input checked="" type="checkbox"/>																																																																
<input checked="" type="checkbox"/>	<input checked="" type="checkbox"/>																																																																
<input type="checkbox"/>	<input type="checkbox"/>																																																																
<input checked="" type="checkbox"/>	<input checked="" type="checkbox"/>																																																																
<input type="checkbox"/>	<input type="checkbox"/>																																																																
<input checked="" type="checkbox"/>	<input checked="" type="checkbox"/>																																																																
<input checked="" type="checkbox"/>	<input checked="" type="checkbox"/>																																																																
1	2																																																																
<input type="checkbox"/>	<input type="checkbox"/>																																																																
<input type="checkbox"/>	<input type="checkbox"/>																																																																
<input type="checkbox"/>	<input type="checkbox"/>																																																																
<input checked="" type="checkbox"/>	<input checked="" type="checkbox"/>																																																																
<input type="checkbox"/>	<input type="checkbox"/>																																																																
1	2																																																																
<input type="checkbox"/>	<input type="checkbox"/>																																																																
<input checked="" type="checkbox"/>	<input checked="" type="checkbox"/>																																																																
<input checked="" type="checkbox"/>	<input checked="" type="checkbox"/>																																																																
<input type="checkbox"/>	<input type="checkbox"/>																																																																
<input type="checkbox"/>	<input type="checkbox"/>																																																																
<input type="checkbox"/>	<input type="checkbox"/>																																																																
<input checked="" type="checkbox"/>	<input checked="" type="checkbox"/>																																																																
<input checked="" type="checkbox"/>	<input checked="" type="checkbox"/>																																																																
1	2																																																																
<input type="checkbox"/>	<input type="checkbox"/>																																																																
<input type="checkbox"/>	<input type="checkbox"/>																																																																
<input type="checkbox"/>	<input type="checkbox"/>																																																																
<input checked="" type="checkbox"/>	<input checked="" type="checkbox"/>																																																																
<input type="checkbox"/>	<input type="checkbox"/>																																																																

CPU TYPE	JP1~6, JP9~10	JP14~JP18	CPU TYPE	JP1~6, JP9~10	JP14~JP18
----------	---------------	-----------	----------	---------------	-----------

**MVP3 SYSTEM BOARD**

**HARDWARE SETUP**

IDT C6-180	60MHz x 3	V <sub>CORE</sub> = 3.5V	IDT C6-200	66MHz x 3	V <sub>CORE</sub> = 3.5V
	1 2  JP1 JP2 JP3 JP4 JP5 JP6 JP9 JP10	1 2  JP14 JP15 JP16 JP17 JP18		1 2  JP1 JP2 JP3 JP4 JP5 JP6 JP9 JP10	1 2  JP14 JP15 JP16 JP17 JP18

CPU TYPE	JP1~6, JP9~10	JP14~JP18	CPU TYPE	JP1~6, JP9~10	JP14~JP18
IDT C6-225	75MHz x 3	V <sub>CORE</sub> = 3.5V	IDT C6-240	60MHz x 4	V <sub>CORE</sub> = 3.5V
	1 2  JP1 JP2 JP3 JP4 JP5 JP6 JP9 JP10	1 2  JP14 JP15 JP16 JP17 JP18		1 2  JP1 JP2 JP3 JP4 JP5 JP6 JP9 JP10	1 2  JP14 JP15 JP16 JP17 JP18

CPU TYPE	JP1~6, JP9~10	JP14~JP18	CPU TYPE	JP1~6, JP9~10	JP14~JP18
IDT WinChip 2 -200	66MHz x 3	V <sub>CORE</sub> = 3.5V	IDT WinChip 2 -233	66MHz x 3.5	V <sub>CORE</sub> = 3.5V
	1 2  JP1 JP2 JP3 JP4 JP5 JP6 JP9 JP10	1 2  JP14 JP15 JP16 JP17 JP18		1 2  JP1 JP2 JP3 JP4 JP5 JP6 JP9 JP10	1 2  JP14 JP15 JP16 JP17 JP18

CPU TYPE	JP1~6, JP9~10	JP14~JP18	CPU TYPE	JP1~6, JP9~10	JP14~JP18
	100MHz x 2.33	V <sub>CORE</sub> = 3.5V		100MHz x 2.5	V <sub>CORE</sub> = 3.5V

**MVP3 SYSTEM BOARD**

**HARDWARE SETUP**

IDT WinChip 2 -266	<table border="1"> <tr><td>1</td><td>2</td></tr> <tr><td><input type="checkbox"/></td><td><input type="checkbox"/></td></tr> <tr><td><input type="checkbox"/></td><td><input type="checkbox"/></td></tr> <tr><td><input type="checkbox"/></td><td><input type="checkbox"/></td></tr> <tr><td><input type="checkbox"/></td><td><input type="checkbox"/></td></tr> <tr><td><input checked="" type="checkbox"/></td><td><input checked="" type="checkbox"/></td></tr> <tr><td><input checked="" type="checkbox"/></td><td><input checked="" type="checkbox"/></td></tr> <tr><td><input type="checkbox"/></td><td><input type="checkbox"/></td></tr> <tr><td><input checked="" type="checkbox"/></td><td><input checked="" type="checkbox"/></td></tr> </table> JP1 JP2 JP3 JP4 JP5 JP6 JP9 JP10	1	2	<input type="checkbox"/>	<input type="checkbox"/>	<input type="checkbox"/>	<input type="checkbox"/>	<input type="checkbox"/>	<input type="checkbox"/>	<input type="checkbox"/>	<input type="checkbox"/>	<input checked="" type="checkbox"/>	<input checked="" type="checkbox"/>	<input checked="" type="checkbox"/>	<input checked="" type="checkbox"/>	<input type="checkbox"/>	<input type="checkbox"/>	<input checked="" type="checkbox"/>	<input checked="" type="checkbox"/>	<table border="1"> <tr><td>1</td><td>2</td></tr> <tr><td><input checked="" type="checkbox"/></td><td><input checked="" type="checkbox"/></td></tr> <tr><td><input checked="" type="checkbox"/></td><td><input checked="" type="checkbox"/></td></tr> <tr><td><input checked="" type="checkbox"/></td><td><input checked="" type="checkbox"/></td></tr> <tr><td><input checked="" type="checkbox"/></td><td><input checked="" type="checkbox"/></td></tr> <tr><td><input type="checkbox"/></td><td><input type="checkbox"/></td></tr> </table> JP14 JP15 JP16 JP17 JP18	1	2	<input checked="" type="checkbox"/>	<input checked="" type="checkbox"/>	<input checked="" type="checkbox"/>	<input checked="" type="checkbox"/>	<input checked="" type="checkbox"/>	<input checked="" type="checkbox"/>	<input checked="" type="checkbox"/>	<input checked="" type="checkbox"/>	<input type="checkbox"/>	<input type="checkbox"/>	IDT WinChip 2 -300	<table border="1"> <tr><td>1</td><td>2</td></tr> <tr><td><input type="checkbox"/></td><td><input type="checkbox"/></td></tr> <tr><td><input type="checkbox"/></td><td><input type="checkbox"/></td></tr> <tr><td><input type="checkbox"/></td><td><input type="checkbox"/></td></tr> <tr><td><input checked="" type="checkbox"/></td><td><input checked="" type="checkbox"/></td></tr> <tr><td><input checked="" type="checkbox"/></td><td><input checked="" type="checkbox"/></td></tr> <tr><td><input type="checkbox"/></td><td><input type="checkbox"/></td></tr> <tr><td><input type="checkbox"/></td><td><input type="checkbox"/></td></tr> <tr><td><input checked="" type="checkbox"/></td><td><input checked="" type="checkbox"/></td></tr> </table> JP1 JP2 JP3 JP4 JP5 JP6 JP9 JP10	1	2	<input type="checkbox"/>	<input type="checkbox"/>	<input type="checkbox"/>	<input type="checkbox"/>	<input type="checkbox"/>	<input type="checkbox"/>	<input checked="" type="checkbox"/>	<input checked="" type="checkbox"/>	<input checked="" type="checkbox"/>	<input checked="" type="checkbox"/>	<input type="checkbox"/>	<input type="checkbox"/>	<input type="checkbox"/>	<input type="checkbox"/>	<input checked="" type="checkbox"/>	<input checked="" type="checkbox"/>	<table border="1"> <tr><td>1</td><td>2</td></tr> <tr><td><input checked="" type="checkbox"/></td><td><input checked="" type="checkbox"/></td></tr> <tr><td><input checked="" type="checkbox"/></td><td><input checked="" type="checkbox"/></td></tr> <tr><td><input checked="" type="checkbox"/></td><td><input checked="" type="checkbox"/></td></tr> <tr><td><input checked="" type="checkbox"/></td><td><input checked="" type="checkbox"/></td></tr> <tr><td><input type="checkbox"/></td><td><input type="checkbox"/></td></tr> </table> JP14 JP15 JP16 JP17 JP18	1	2	<input checked="" type="checkbox"/>	<input checked="" type="checkbox"/>	<input checked="" type="checkbox"/>	<input checked="" type="checkbox"/>	<input checked="" type="checkbox"/>	<input checked="" type="checkbox"/>	<input checked="" type="checkbox"/>	<input checked="" type="checkbox"/>	<input type="checkbox"/>	<input type="checkbox"/>				
1	2																																																																				
<input type="checkbox"/>	<input type="checkbox"/>																																																																				
<input type="checkbox"/>	<input type="checkbox"/>																																																																				
<input type="checkbox"/>	<input type="checkbox"/>																																																																				
<input type="checkbox"/>	<input type="checkbox"/>																																																																				
<input checked="" type="checkbox"/>	<input checked="" type="checkbox"/>																																																																				
<input checked="" type="checkbox"/>	<input checked="" type="checkbox"/>																																																																				
<input type="checkbox"/>	<input type="checkbox"/>																																																																				
<input checked="" type="checkbox"/>	<input checked="" type="checkbox"/>																																																																				
1	2																																																																				
<input checked="" type="checkbox"/>	<input checked="" type="checkbox"/>																																																																				
<input checked="" type="checkbox"/>	<input checked="" type="checkbox"/>																																																																				
<input checked="" type="checkbox"/>	<input checked="" type="checkbox"/>																																																																				
<input checked="" type="checkbox"/>	<input checked="" type="checkbox"/>																																																																				
<input type="checkbox"/>	<input type="checkbox"/>																																																																				
1	2																																																																				
<input type="checkbox"/>	<input type="checkbox"/>																																																																				
<input type="checkbox"/>	<input type="checkbox"/>																																																																				
<input type="checkbox"/>	<input type="checkbox"/>																																																																				
<input checked="" type="checkbox"/>	<input checked="" type="checkbox"/>																																																																				
<input checked="" type="checkbox"/>	<input checked="" type="checkbox"/>																																																																				
<input type="checkbox"/>	<input type="checkbox"/>																																																																				
<input type="checkbox"/>	<input type="checkbox"/>																																																																				
<input checked="" type="checkbox"/>	<input checked="" type="checkbox"/>																																																																				
1	2																																																																				
<input checked="" type="checkbox"/>	<input checked="" type="checkbox"/>																																																																				
<input checked="" type="checkbox"/>	<input checked="" type="checkbox"/>																																																																				
<input checked="" type="checkbox"/>	<input checked="" type="checkbox"/>																																																																				
<input checked="" type="checkbox"/>	<input checked="" type="checkbox"/>																																																																				
<input type="checkbox"/>	<input type="checkbox"/>																																																																				
CPU TYPE	JP1~6, JP9~10	JP14~JP18	CPU TYPE	JP1~6, JP9~10	JP14~JP18																																																																
IDT WinChip 3 -266	66MHz x 3.5 <table border="1"> <tr><td>1</td><td>2</td></tr> <tr><td><input type="checkbox"/></td><td><input type="checkbox"/></td></tr> <tr><td><input checked="" type="checkbox"/></td><td><input checked="" type="checkbox"/></td></tr> <tr><td><input checked="" type="checkbox"/></td><td><input checked="" type="checkbox"/></td></tr> <tr><td><input type="checkbox"/></td><td><input type="checkbox"/></td></tr> <tr><td><input type="checkbox"/></td><td><input type="checkbox"/></td></tr> <tr><td><input type="checkbox"/></td><td><input type="checkbox"/></td></tr> <tr><td><input checked="" type="checkbox"/></td><td><input checked="" type="checkbox"/></td></tr> <tr><td><input checked="" type="checkbox"/></td><td><input checked="" type="checkbox"/></td></tr> </table> JP1 JP2 JP3 JP4 JP5 JP6 JP9 JP10	1	2	<input type="checkbox"/>	<input type="checkbox"/>	<input checked="" type="checkbox"/>	<input checked="" type="checkbox"/>	<input checked="" type="checkbox"/>	<input checked="" type="checkbox"/>	<input type="checkbox"/>	<input type="checkbox"/>	<input type="checkbox"/>	<input type="checkbox"/>	<input type="checkbox"/>	<input type="checkbox"/>	<input checked="" type="checkbox"/>	<input checked="" type="checkbox"/>	<input checked="" type="checkbox"/>	<input checked="" type="checkbox"/>	V <sub>CORE</sub> = 2.8V <table border="1"> <tr><td>1</td><td>2</td></tr> <tr><td><input type="checkbox"/></td><td><input type="checkbox"/></td></tr> <tr><td><input type="checkbox"/></td><td><input type="checkbox"/></td></tr> <tr><td><input type="checkbox"/></td><td><input type="checkbox"/></td></tr> <tr><td><input checked="" type="checkbox"/></td><td><input checked="" type="checkbox"/></td></tr> <tr><td><input type="checkbox"/></td><td><input type="checkbox"/></td></tr> </table> JP14 JP15 JP16 JP17 JP18	1	2	<input type="checkbox"/>	<input type="checkbox"/>	<input type="checkbox"/>	<input type="checkbox"/>	<input type="checkbox"/>	<input type="checkbox"/>	<input checked="" type="checkbox"/>	<input checked="" type="checkbox"/>	<input type="checkbox"/>	<input type="checkbox"/>	IDT WinChip 3 300	66MHz x 4 <table border="1"> <tr><td>1</td><td>2</td></tr> <tr><td><input type="checkbox"/></td><td><input type="checkbox"/></td></tr> <tr><td><input checked="" type="checkbox"/></td><td><input checked="" type="checkbox"/></td></tr> <tr><td><input checked="" type="checkbox"/></td><td><input checked="" type="checkbox"/></td></tr> <tr><td><input checked="" type="checkbox"/></td><td><input checked="" type="checkbox"/></td></tr> <tr><td><input type="checkbox"/></td><td><input type="checkbox"/></td></tr> <tr><td><input checked="" type="checkbox"/></td><td><input checked="" type="checkbox"/></td></tr> <tr><td><input checked="" type="checkbox"/></td><td><input checked="" type="checkbox"/></td></tr> <tr><td><input checked="" type="checkbox"/></td><td><input checked="" type="checkbox"/></td></tr> </table> JP1 JP2 JP3 JP4 JP5 JP6 JP9 JP10	1	2	<input type="checkbox"/>	<input type="checkbox"/>	<input checked="" type="checkbox"/>	<input checked="" type="checkbox"/>	<input checked="" type="checkbox"/>	<input checked="" type="checkbox"/>	<input checked="" type="checkbox"/>	<input checked="" type="checkbox"/>	<input type="checkbox"/>	<input type="checkbox"/>	<input checked="" type="checkbox"/>	<input checked="" type="checkbox"/>	<input checked="" type="checkbox"/>	<input checked="" type="checkbox"/>	<input checked="" type="checkbox"/>	<input checked="" type="checkbox"/>	<table border="1"> <tr><td>1</td><td>2</td></tr> <tr><td><input type="checkbox"/></td><td><input type="checkbox"/></td></tr> <tr><td><input type="checkbox"/></td><td><input type="checkbox"/></td></tr> <tr><td><input type="checkbox"/></td><td><input type="checkbox"/></td></tr> <tr><td><input checked="" type="checkbox"/></td><td><input checked="" type="checkbox"/></td></tr> <tr><td><input type="checkbox"/></td><td><input type="checkbox"/></td></tr> </table> JP14 JP15 JP16 JP17 JP18	1	2	<input type="checkbox"/>	<input type="checkbox"/>	<input type="checkbox"/>	<input type="checkbox"/>	<input type="checkbox"/>	<input type="checkbox"/>	<input checked="" type="checkbox"/>	<input checked="" type="checkbox"/>	<input type="checkbox"/>	<input type="checkbox"/>				
1	2																																																																				
<input type="checkbox"/>	<input type="checkbox"/>																																																																				
<input checked="" type="checkbox"/>	<input checked="" type="checkbox"/>																																																																				
<input checked="" type="checkbox"/>	<input checked="" type="checkbox"/>																																																																				
<input type="checkbox"/>	<input type="checkbox"/>																																																																				
<input type="checkbox"/>	<input type="checkbox"/>																																																																				
<input type="checkbox"/>	<input type="checkbox"/>																																																																				
<input checked="" type="checkbox"/>	<input checked="" type="checkbox"/>																																																																				
<input checked="" type="checkbox"/>	<input checked="" type="checkbox"/>																																																																				
1	2																																																																				
<input type="checkbox"/>	<input type="checkbox"/>																																																																				
<input type="checkbox"/>	<input type="checkbox"/>																																																																				
<input type="checkbox"/>	<input type="checkbox"/>																																																																				
<input checked="" type="checkbox"/>	<input checked="" type="checkbox"/>																																																																				
<input type="checkbox"/>	<input type="checkbox"/>																																																																				
1	2																																																																				
<input type="checkbox"/>	<input type="checkbox"/>																																																																				
<input checked="" type="checkbox"/>	<input checked="" type="checkbox"/>																																																																				
<input checked="" type="checkbox"/>	<input checked="" type="checkbox"/>																																																																				
<input checked="" type="checkbox"/>	<input checked="" type="checkbox"/>																																																																				
<input type="checkbox"/>	<input type="checkbox"/>																																																																				
<input checked="" type="checkbox"/>	<input checked="" type="checkbox"/>																																																																				
<input checked="" type="checkbox"/>	<input checked="" type="checkbox"/>																																																																				
<input checked="" type="checkbox"/>	<input checked="" type="checkbox"/>																																																																				
1	2																																																																				
<input type="checkbox"/>	<input type="checkbox"/>																																																																				
<input type="checkbox"/>	<input type="checkbox"/>																																																																				
<input type="checkbox"/>	<input type="checkbox"/>																																																																				
<input checked="" type="checkbox"/>	<input checked="" type="checkbox"/>																																																																				
<input type="checkbox"/>	<input type="checkbox"/>																																																																				
CPU TYPE	JP1~6, JP9~10	JP14~JP18	CPU TYPE	JP1~6, JP9~10	JP14~JP18																																																																
IDT WinChip 3 -333	100MHz x 2.66 <table border="1"> <tr><td>1</td><td>2</td></tr> <tr><td><input type="checkbox"/></td><td><input type="checkbox"/></td></tr> <tr><td><input type="checkbox"/></td><td><input type="checkbox"/></td></tr> <tr><td><input type="checkbox"/></td><td><input type="checkbox"/></td></tr> <tr><td><input type="checkbox"/></td><td><input type="checkbox"/></td></tr> <tr><td><input type="checkbox"/></td><td><input type="checkbox"/></td></tr> <tr><td><input checked="" type="checkbox"/></td><td><input checked="" type="checkbox"/></td></tr> <tr><td><input checked="" type="checkbox"/></td><td><input checked="" type="checkbox"/></td></tr> <tr><td><input type="checkbox"/></td><td><input type="checkbox"/></td></tr> <tr><td><input checked="" type="checkbox"/></td><td><input checked="" type="checkbox"/></td></tr> </table> JP1 JP2 JP3 JP4 JP5 JP6 JP9 JP10	1	2	<input type="checkbox"/>	<input type="checkbox"/>	<input type="checkbox"/>	<input type="checkbox"/>	<input type="checkbox"/>	<input type="checkbox"/>	<input type="checkbox"/>	<input type="checkbox"/>	<input type="checkbox"/>	<input type="checkbox"/>	<input checked="" type="checkbox"/>	<input checked="" type="checkbox"/>	<input checked="" type="checkbox"/>	<input checked="" type="checkbox"/>	<input type="checkbox"/>	<input type="checkbox"/>	<input checked="" type="checkbox"/>	<input checked="" type="checkbox"/>	V <sub>CORE</sub> = 2.8V <table border="1"> <tr><td>1</td><td>2</td></tr> <tr><td><input type="checkbox"/></td><td><input type="checkbox"/></td></tr> <tr><td><input type="checkbox"/></td><td><input type="checkbox"/></td></tr> <tr><td><input type="checkbox"/></td><td><input type="checkbox"/></td></tr> <tr><td><input checked="" type="checkbox"/></td><td><input checked="" type="checkbox"/></td></tr> <tr><td><input type="checkbox"/></td><td><input type="checkbox"/></td></tr> </table> JP14 JP15 JP16 JP17 JP18	1	2	<input type="checkbox"/>	<input type="checkbox"/>	<input type="checkbox"/>	<input type="checkbox"/>	<input type="checkbox"/>	<input type="checkbox"/>	<input checked="" type="checkbox"/>	<input checked="" type="checkbox"/>	<input type="checkbox"/>	<input type="checkbox"/>	IDT WinChip 3 -350	95MHz x 3 <table border="1"> <tr><td>1</td><td>2</td></tr> <tr><td><input checked="" type="checkbox"/></td><td><input checked="" type="checkbox"/></td></tr> <tr><td><input type="checkbox"/></td><td><input type="checkbox"/></td></tr> <tr><td><input type="checkbox"/></td><td><input type="checkbox"/></td></tr> <tr><td><input type="checkbox"/></td><td><input type="checkbox"/></td></tr> <tr><td><input type="checkbox"/></td><td><input type="checkbox"/></td></tr> <tr><td><input checked="" type="checkbox"/></td><td><input checked="" type="checkbox"/></td></tr> <tr><td><input type="checkbox"/></td><td><input type="checkbox"/></td></tr> <tr><td><input type="checkbox"/></td><td><input type="checkbox"/></td></tr> <tr><td><input checked="" type="checkbox"/></td><td><input checked="" type="checkbox"/></td></tr> </table> JP1 JP2 JP3 JP4 JP5 JP6 JP9 JP10	1	2	<input checked="" type="checkbox"/>	<input checked="" type="checkbox"/>	<input type="checkbox"/>	<input type="checkbox"/>	<input type="checkbox"/>	<input type="checkbox"/>	<input type="checkbox"/>	<input type="checkbox"/>	<input type="checkbox"/>	<input type="checkbox"/>	<input checked="" type="checkbox"/>	<input checked="" type="checkbox"/>	<input type="checkbox"/>	<input type="checkbox"/>	<input type="checkbox"/>	<input type="checkbox"/>	<input checked="" type="checkbox"/>	<input checked="" type="checkbox"/>	<table border="1"> <tr><td>1</td><td>2</td></tr> <tr><td><input type="checkbox"/></td><td><input type="checkbox"/></td></tr> <tr><td><input type="checkbox"/></td><td><input type="checkbox"/></td></tr> <tr><td><input type="checkbox"/></td><td><input type="checkbox"/></td></tr> <tr><td><input checked="" type="checkbox"/></td><td><input checked="" type="checkbox"/></td></tr> <tr><td><input type="checkbox"/></td><td><input type="checkbox"/></td></tr> </table> JP14 JP15 JP16 JP17 JP18	1	2	<input type="checkbox"/>	<input type="checkbox"/>	<input type="checkbox"/>	<input type="checkbox"/>	<input type="checkbox"/>	<input type="checkbox"/>	<input checked="" type="checkbox"/>	<input checked="" type="checkbox"/>	<input type="checkbox"/>	<input type="checkbox"/>
1	2																																																																				
<input type="checkbox"/>	<input type="checkbox"/>																																																																				
<input type="checkbox"/>	<input type="checkbox"/>																																																																				
<input type="checkbox"/>	<input type="checkbox"/>																																																																				
<input type="checkbox"/>	<input type="checkbox"/>																																																																				
<input type="checkbox"/>	<input type="checkbox"/>																																																																				
<input checked="" type="checkbox"/>	<input checked="" type="checkbox"/>																																																																				
<input checked="" type="checkbox"/>	<input checked="" type="checkbox"/>																																																																				
<input type="checkbox"/>	<input type="checkbox"/>																																																																				
<input checked="" type="checkbox"/>	<input checked="" type="checkbox"/>																																																																				
1	2																																																																				
<input type="checkbox"/>	<input type="checkbox"/>																																																																				
<input type="checkbox"/>	<input type="checkbox"/>																																																																				
<input type="checkbox"/>	<input type="checkbox"/>																																																																				
<input checked="" type="checkbox"/>	<input checked="" type="checkbox"/>																																																																				
<input type="checkbox"/>	<input type="checkbox"/>																																																																				
1	2																																																																				
<input checked="" type="checkbox"/>	<input checked="" type="checkbox"/>																																																																				
<input type="checkbox"/>	<input type="checkbox"/>																																																																				
<input type="checkbox"/>	<input type="checkbox"/>																																																																				
<input type="checkbox"/>	<input type="checkbox"/>																																																																				
<input type="checkbox"/>	<input type="checkbox"/>																																																																				
<input checked="" type="checkbox"/>	<input checked="" type="checkbox"/>																																																																				
<input type="checkbox"/>	<input type="checkbox"/>																																																																				
<input type="checkbox"/>	<input type="checkbox"/>																																																																				
<input checked="" type="checkbox"/>	<input checked="" type="checkbox"/>																																																																				
1	2																																																																				
<input type="checkbox"/>	<input type="checkbox"/>																																																																				
<input type="checkbox"/>	<input type="checkbox"/>																																																																				
<input type="checkbox"/>	<input type="checkbox"/>																																																																				
<input checked="" type="checkbox"/>	<input checked="" type="checkbox"/>																																																																				
<input type="checkbox"/>	<input type="checkbox"/>																																																																				
CPU TYPE	JP1~6, JP9~10	JP14~JP18	CPU TYPE	JP1~6, JP9~10	JP14~JP18																																																																

**(B) OTHER CPU CLOCK SETTING RESERVED ON THE BOARD :**

66MHz x 5	66MHz x 5.5	75MHz x 3.5	75MHz x 4	75MHz x 4.5
-----------	-------------	-------------	-----------	-------------

<p>1 2</p> <p><input type="checkbox"/> <input type="checkbox"/> JP1</p> <p><input checked="" type="checkbox"/> <input checked="" type="checkbox"/> JP2</p> <p><input checked="" type="checkbox"/> <input checked="" type="checkbox"/> JP3</p> <p><input type="checkbox"/> <input type="checkbox"/> JP4</p> <p><input checked="" type="checkbox"/> <input checked="" type="checkbox"/> JP5</p> <p><input checked="" type="checkbox"/> <input checked="" type="checkbox"/> JP6</p> <p><input checked="" type="checkbox"/> <input checked="" type="checkbox"/> JP9</p> <p><input checked="" type="checkbox"/> <input checked="" type="checkbox"/> JP10</p>	<p>1 2</p> <p><input type="checkbox"/> <input type="checkbox"/> JP1</p> <p><input checked="" type="checkbox"/> <input checked="" type="checkbox"/> JP2</p> <p><input checked="" type="checkbox"/> <input checked="" type="checkbox"/> JP3</p> <p><input type="checkbox"/> <input type="checkbox"/> JP4</p> <p><input type="checkbox"/> <input type="checkbox"/> JP5</p> <p><input checked="" type="checkbox"/> <input checked="" type="checkbox"/> JP6</p> <p><input checked="" type="checkbox"/> <input checked="" type="checkbox"/> JP9</p> <p><input checked="" type="checkbox"/> <input checked="" type="checkbox"/> JP10</p>	<p>1 2</p> <p><input checked="" type="checkbox"/> <input checked="" type="checkbox"/> JP1</p> <p><input checked="" type="checkbox"/> <input checked="" type="checkbox"/> JP2</p> <p><input type="checkbox"/> <input type="checkbox"/> JP3</p> <p><input type="checkbox"/> <input type="checkbox"/> JP4</p> <p><input type="checkbox"/> <input type="checkbox"/> JP5</p> <p><input type="checkbox"/> <input type="checkbox"/> JP6</p> <p><input type="checkbox"/> <input type="checkbox"/> JP9</p> <p><input type="checkbox"/> <input type="checkbox"/> JP10</p>	<p>1 2</p> <p><input checked="" type="checkbox"/> <input checked="" type="checkbox"/> JP1</p> <p><input checked="" type="checkbox"/> <input checked="" type="checkbox"/> JP2</p> <p><input type="checkbox"/> <input type="checkbox"/> JP3</p> <p><input checked="" type="checkbox"/> <input checked="" type="checkbox"/> JP4</p> <p><input type="checkbox"/> <input type="checkbox"/> JP5</p> <p><input checked="" type="checkbox"/> <input checked="" type="checkbox"/> JP6</p> <p><input type="checkbox"/> <input type="checkbox"/> JP9</p> <p><input type="checkbox"/> <input type="checkbox"/> JP10</p>	<p>1 2</p> <p><input checked="" type="checkbox"/> <input checked="" type="checkbox"/> JP1</p> <p><input checked="" type="checkbox"/> <input checked="" type="checkbox"/> JP2</p> <p><input type="checkbox"/> <input type="checkbox"/> JP3</p> <p><input checked="" type="checkbox"/> <input checked="" type="checkbox"/> JP4</p> <p><input checked="" type="checkbox"/> <input checked="" type="checkbox"/> JP5</p> <p><input checked="" type="checkbox"/> <input checked="" type="checkbox"/> JP6</p> <p><input type="checkbox"/> <input type="checkbox"/> JP9</p> <p><input type="checkbox"/> <input type="checkbox"/> JP10</p>
---	---	---	---	---

<b>75MHz x 5</b>	<b>83MHz x 3.5</b>	<b>83MHz x 4</b>	<b>83MHz x 4.5</b>	<b>83MHz x 5</b>
<p>1 2</p> <p><input checked="" type="checkbox"/> <input checked="" type="checkbox"/> JP1</p> <p><input checked="" type="checkbox"/> <input checked="" type="checkbox"/> JP2</p> <p><input type="checkbox"/> <input type="checkbox"/> JP3</p> <p><input type="checkbox"/> <input type="checkbox"/> JP4</p> <p><input checked="" type="checkbox"/> <input checked="" type="checkbox"/> JP5</p> <p><input checked="" type="checkbox"/> <input checked="" type="checkbox"/> JP6</p> <p><input type="checkbox"/> <input type="checkbox"/> JP9</p> <p><input type="checkbox"/> <input type="checkbox"/> JP10</p>	<p>1 2</p> <p><input type="checkbox"/> <input type="checkbox"/> JP1</p> <p><input checked="" type="checkbox"/> <input checked="" type="checkbox"/> JP2</p> <p><input type="checkbox"/> <input type="checkbox"/> JP3</p> <p><input type="checkbox"/> <input type="checkbox"/> JP4</p> <p><input type="checkbox"/> <input type="checkbox"/> JP5</p> <p><input type="checkbox"/> <input type="checkbox"/> JP6</p> <p><input type="checkbox"/> <input type="checkbox"/> JP9</p> <p><input type="checkbox"/> <input type="checkbox"/> JP10</p>	<p>1 2</p> <p><input type="checkbox"/> <input type="checkbox"/> JP1</p> <p><input checked="" type="checkbox"/> <input checked="" type="checkbox"/> JP2</p> <p><input type="checkbox"/> <input type="checkbox"/> JP3</p> <p><input checked="" type="checkbox"/> <input checked="" type="checkbox"/> JP4</p> <p><input type="checkbox"/> <input type="checkbox"/> JP5</p> <p><input checked="" type="checkbox"/> <input checked="" type="checkbox"/> JP6</p> <p><input type="checkbox"/> <input type="checkbox"/> JP9</p> <p><input type="checkbox"/> <input type="checkbox"/> JP10</p>	<p>1 2</p> <p><input type="checkbox"/> <input type="checkbox"/> JP1</p> <p><input checked="" type="checkbox"/> <input checked="" type="checkbox"/> JP2</p> <p><input type="checkbox"/> <input type="checkbox"/> JP3</p> <p><input checked="" type="checkbox"/> <input checked="" type="checkbox"/> JP4</p> <p><input checked="" type="checkbox"/> <input checked="" type="checkbox"/> JP5</p> <p><input checked="" type="checkbox"/> <input checked="" type="checkbox"/> JP6</p> <p><input type="checkbox"/> <input type="checkbox"/> JP9</p> <p><input type="checkbox"/> <input type="checkbox"/> JP10</p>	<p>1 2</p> <p><input type="checkbox"/> <input type="checkbox"/> JP1</p> <p><input checked="" type="checkbox"/> <input checked="" type="checkbox"/> JP2</p> <p><input type="checkbox"/> <input type="checkbox"/> JP3</p> <p><input type="checkbox"/> <input type="checkbox"/> JP4</p> <p><input checked="" type="checkbox"/> <input checked="" type="checkbox"/> JP5</p> <p><input checked="" type="checkbox"/> <input checked="" type="checkbox"/> JP6</p> <p><input type="checkbox"/> <input type="checkbox"/> JP9</p> <p><input type="checkbox"/> <input type="checkbox"/> JP10</p>

<b>83MHz x 5.5</b>	<b>95MHz x 3</b>	<b>95MHz x 3.5</b>	<b>95MHz x 4</b>	<b>95MHz x 4.5</b>
<p>1 2</p> <p><input type="checkbox"/> <input type="checkbox"/> JP1</p> <p><input checked="" type="checkbox"/> <input checked="" type="checkbox"/> JP2</p> <p><input type="checkbox"/> <input type="checkbox"/> JP3</p> <p><input type="checkbox"/> <input type="checkbox"/> JP4</p> <p><input type="checkbox"/> <input type="checkbox"/> JP5</p> <p><input checked="" type="checkbox"/> <input checked="" type="checkbox"/> JP6</p> <p><input type="checkbox"/> <input type="checkbox"/> JP9</p> <p><input type="checkbox"/> <input type="checkbox"/> JP10</p>	<p>1 2</p> <p><input checked="" type="checkbox"/> <input checked="" type="checkbox"/> JP1</p> <p><input type="checkbox"/> <input type="checkbox"/> JP2</p> <p><input type="checkbox"/> <input type="checkbox"/> JP3</p> <p><input type="checkbox"/> <input type="checkbox"/> JP4</p> <p><input checked="" type="checkbox"/> <input checked="" type="checkbox"/> JP5</p> <p><input type="checkbox"/> <input type="checkbox"/> JP6</p> <p><input type="checkbox"/> <input type="checkbox"/> JP9</p> <p><input checked="" type="checkbox"/> <input checked="" type="checkbox"/> JP10</p>	<p>1 2</p> <p><input checked="" type="checkbox"/> <input checked="" type="checkbox"/> JP1</p> <p><input type="checkbox"/> <input type="checkbox"/> JP2</p> <p><input type="checkbox"/> <input type="checkbox"/> JP3</p> <p><input type="checkbox"/> <input type="checkbox"/> JP4</p> <p><input type="checkbox"/> <input type="checkbox"/> JP5</p> <p><input type="checkbox"/> <input type="checkbox"/> JP6</p> <p><input type="checkbox"/> <input type="checkbox"/> JP9</p> <p><input checked="" type="checkbox"/> <input checked="" type="checkbox"/> JP10</p>	<p>1 2</p> <p><input checked="" type="checkbox"/> <input checked="" type="checkbox"/> JP1</p> <p><input type="checkbox"/> <input type="checkbox"/> JP2</p> <p><input type="checkbox"/> <input type="checkbox"/> JP3</p> <p><input checked="" type="checkbox"/> <input checked="" type="checkbox"/> JP4</p> <p><input type="checkbox"/> <input type="checkbox"/> JP5</p> <p><input checked="" type="checkbox"/> <input checked="" type="checkbox"/> JP6</p> <p><input type="checkbox"/> <input type="checkbox"/> JP9</p> <p><input checked="" type="checkbox"/> <input checked="" type="checkbox"/> JP10</p>	<p>1 2</p> <p><input checked="" type="checkbox"/> <input checked="" type="checkbox"/> JP1</p> <p><input type="checkbox"/> <input type="checkbox"/> JP2</p> <p><input type="checkbox"/> <input type="checkbox"/> JP3</p> <p><input checked="" type="checkbox"/> <input checked="" type="checkbox"/> JP4</p> <p><input checked="" type="checkbox"/> <input checked="" type="checkbox"/> JP5</p> <p><input checked="" type="checkbox"/> <input checked="" type="checkbox"/> JP6</p> <p><input type="checkbox"/> <input type="checkbox"/> JP9</p> <p><input checked="" type="checkbox"/> <input checked="" type="checkbox"/> JP10</p>

<b>95MHz x 5</b>	<b>95MHz x 5.5</b>	<b>100MHz x 3.5</b>	<b>100MHz x 4</b>	<b>100MHz x 4.5</b>
<p>1 2</p> <p><input checked="" type="checkbox"/> <input checked="" type="checkbox"/> JP1</p>	<p>1 2</p> <p><input checked="" type="checkbox"/> <input checked="" type="checkbox"/> JP1</p>	<p>1 2</p> <p><input type="checkbox"/> <input type="checkbox"/> JP1</p>	<p>1 2</p> <p><input type="checkbox"/> <input type="checkbox"/> JP1</p>	<p>1 2</p> <p><input type="checkbox"/> <input type="checkbox"/> JP1</p>

<input type="checkbox"/> <input type="checkbox"/> JP2	<input type="checkbox"/> <input type="checkbox"/> JP2	<input type="checkbox"/> <input type="checkbox"/> JP2	<input type="checkbox"/> <input type="checkbox"/> JP2	<input type="checkbox"/> <input type="checkbox"/> JP2
<input type="checkbox"/> <input type="checkbox"/> JP3	<input type="checkbox"/> <input type="checkbox"/> JP3	<input type="checkbox"/> <input type="checkbox"/> JP3	<input type="checkbox"/> <input type="checkbox"/> JP3	<input type="checkbox"/> <input type="checkbox"/> JP3
<input type="checkbox"/> <input type="checkbox"/> JP4	<input type="checkbox"/> <input type="checkbox"/> JP4	<input type="checkbox"/> <input type="checkbox"/> JP4	<input checked="" type="checkbox"/> <input checked="" type="checkbox"/> JP4	<input checked="" type="checkbox"/> <input checked="" type="checkbox"/> JP4
<input checked="" type="checkbox"/> <input checked="" type="checkbox"/> JP5	<input type="checkbox"/> <input type="checkbox"/> JP5	<input type="checkbox"/> <input type="checkbox"/> JP5	<input type="checkbox"/> <input type="checkbox"/> JP5	<input checked="" type="checkbox"/> <input checked="" type="checkbox"/> JP5
<input checked="" type="checkbox"/> <input checked="" type="checkbox"/> JP6	<input checked="" type="checkbox"/> <input checked="" type="checkbox"/> JP6	<input type="checkbox"/> <input type="checkbox"/> JP6	<input checked="" type="checkbox"/> <input checked="" type="checkbox"/> JP6	<input checked="" type="checkbox"/> <input checked="" type="checkbox"/> JP6
<input type="checkbox"/> <input type="checkbox"/> JP9	<input type="checkbox"/> <input type="checkbox"/> JP9	<input type="checkbox"/> <input type="checkbox"/> JP9	<input type="checkbox"/> <input type="checkbox"/> JP9	<input type="checkbox"/> <input type="checkbox"/> JP9
<input checked="" type="checkbox"/> <input checked="" type="checkbox"/> JP10	<input checked="" type="checkbox"/> <input checked="" type="checkbox"/> JP10	<input checked="" type="checkbox"/> <input checked="" type="checkbox"/> JP10	<input checked="" type="checkbox"/> <input checked="" type="checkbox"/> JP10	<input checked="" type="checkbox"/> <input checked="" type="checkbox"/> JP10

100MHz x 5		100MHz x 5.5	
1	2	1	2
<input type="checkbox"/>	<input type="checkbox"/> JP1	<input type="checkbox"/>	<input type="checkbox"/> JP1
<input type="checkbox"/>	<input type="checkbox"/> JP2	<input type="checkbox"/>	<input type="checkbox"/> JP2
<input type="checkbox"/>	<input type="checkbox"/> JP3	<input type="checkbox"/>	<input type="checkbox"/> JP3
<input type="checkbox"/>	<input type="checkbox"/> JP4	<input type="checkbox"/>	<input type="checkbox"/> JP4
<input checked="" type="checkbox"/>	<input checked="" type="checkbox"/> JP5	<input type="checkbox"/>	<input type="checkbox"/> JP5
<input checked="" type="checkbox"/>	<input checked="" type="checkbox"/> JP6	<input checked="" type="checkbox"/>	<input checked="" type="checkbox"/> JP6
<input type="checkbox"/>	<input type="checkbox"/> JP9	<input type="checkbox"/>	<input type="checkbox"/> JP9
<input checked="" type="checkbox"/>	<input checked="" type="checkbox"/> JP10	<input checked="" type="checkbox"/>	<input checked="" type="checkbox"/> JP10

**(C) For IDT CPU Clock and Ratio**

Clock = 60MHz	66MHz	75MHz	83MHz	95MHz	
1	2	1	2	1	2
<input checked="" type="checkbox"/>	<input checked="" type="checkbox"/> JP1	<input checked="" type="checkbox"/>	<input type="checkbox"/>	<input checked="" type="checkbox"/>	<input checked="" type="checkbox"/> JP1
<input checked="" type="checkbox"/>	<input checked="" type="checkbox"/> JP2	<input checked="" type="checkbox"/>	<input checked="" type="checkbox"/>	<input type="checkbox"/>	<input type="checkbox"/> JP2
<input checked="" type="checkbox"/>	<input checked="" type="checkbox"/> JP3	<input type="checkbox"/>	<input type="checkbox"/>	<input type="checkbox"/>	<input type="checkbox"/> JP3
<input checked="" type="checkbox"/>	<input checked="" type="checkbox"/> JP9	<input type="checkbox"/>	<input type="checkbox"/>	<input type="checkbox"/>	<input type="checkbox"/> JP9
<input checked="" type="checkbox"/>	<input checked="" type="checkbox"/> JP10	<input type="checkbox"/>	<input type="checkbox"/>	<input checked="" type="checkbox"/>	<input checked="" type="checkbox"/> JP10

100MHz	
1	2
<input type="checkbox"/>	<input type="checkbox"/> JP1
<input type="checkbox"/>	<input type="checkbox"/> JP2

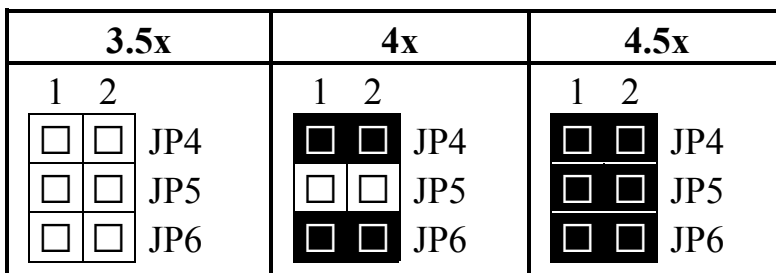
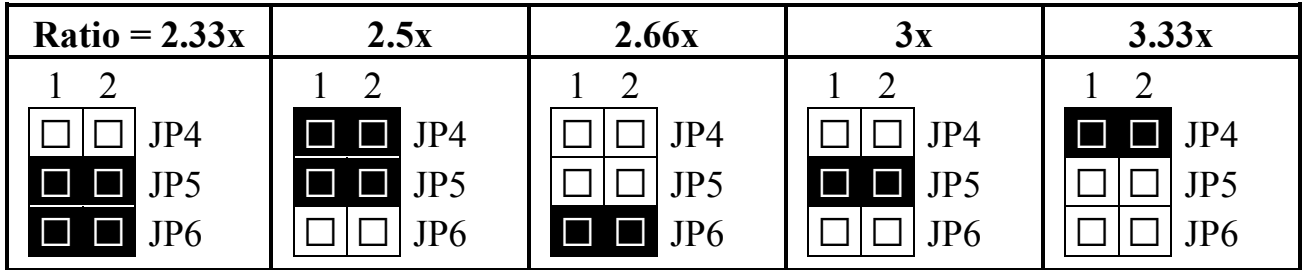
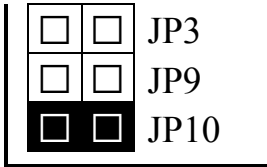

**(D) OTHER CPU VOLTAGE SETTING RESERVED ON THE BOARD:**

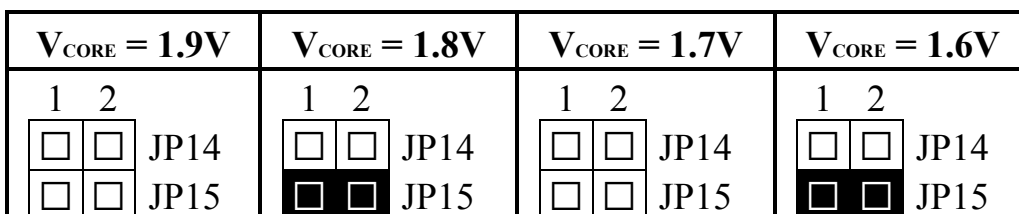
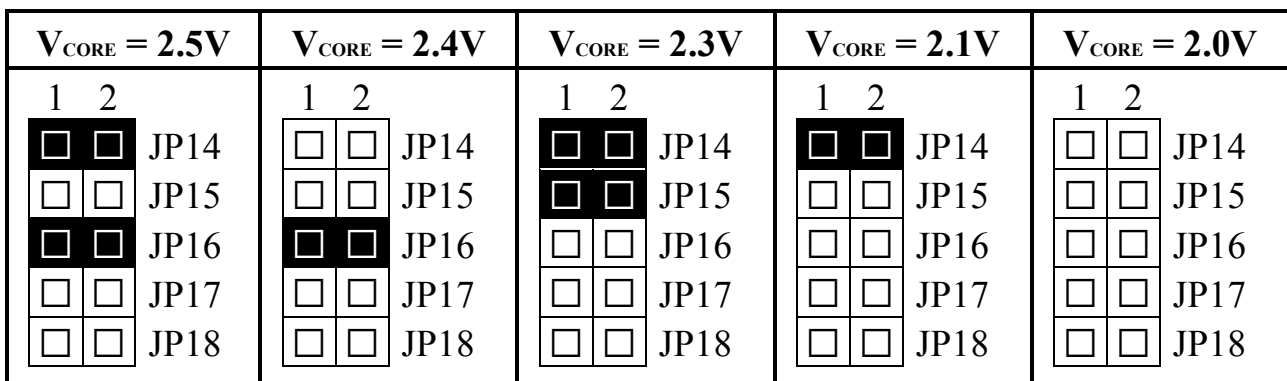
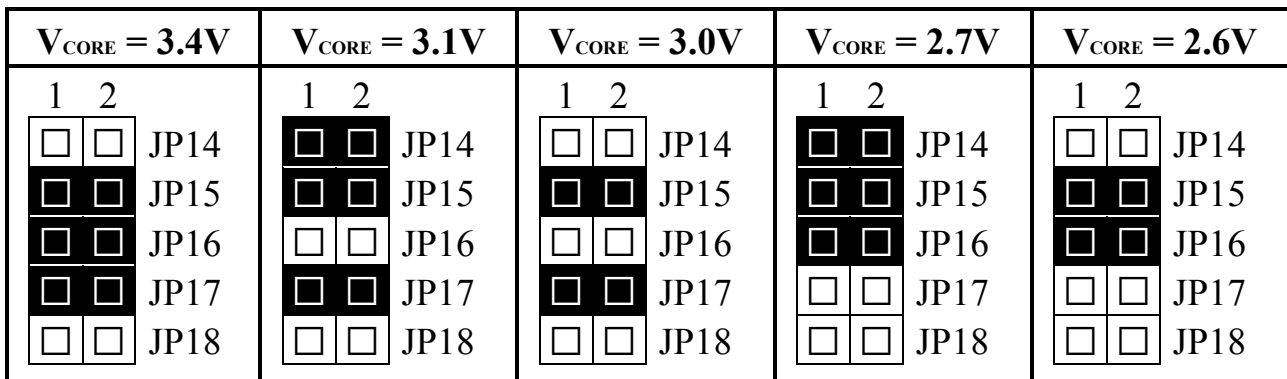

**(E) JP12** Clear CMOS button

<u>Pin #</u>	<u>Function</u>
1 - 2	Normal Operation
2 - 3	Clear CMOS

*Note: Improper BIOS setting may cause hang-up to the PC system, Should it be happened, you can use JP12 to clear the information which is stored in the CMOS memory and get the PC system back to normal status. Improper connection may cause permanent damage to the mainboard. Please refer to the following steps to clear the CMOS*

- 1. Unplug the AC power cable from the PC system.*
- 2. Put the mini jumper on pin 2-3 of JP12 around 3 to 5 seconds will clear the CMOS data, and then return it to the original position ( pin 1-2 ).*
- 3. Re-connect the AC power cable.*

**(F) JP7, JP8** DRAM Clock selection

JP7 and JP8 allow you to adjust the SDRAM clock of the memory sub-system. When you select AGP clock, the system memory will be running at 66MHz (PC-66). When you select CPU clock, the SDRAM clock will be the same speed of CPU FSB clock. Followings are the settings of JP7 and JP8:

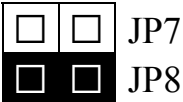
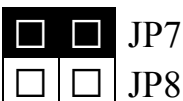
JP7, JP8	SDRAM CLOCK SELECT
<p>1 2</p> 	SDRAM CLOCK = CPU CLOCK
<p>1 2</p> 	SDRAM CLOCK = AGP CLOCK

**3.2.3 SUGGESTED MEMORY MODULES**

This mainboard has three banks of main memory (bank0 - 2) on board (DIMM 1-3) each bank can be single-sided or double-sided, 8MB up to 1GB of local memory can

be populated on the board. Standard fast page mode (FPM), Extended Data Out (EDO) and synchronous DRAM (SDRAM) memory are all supported by this mainboard.

The suggested DRAM modules to use on this mainboard is shown as following. :

- (1) FPM and EDO memory : 512Kbx32 **(2MB)**, 1Mbx32 **(4MB)**,  
2Mbx32 **(8MB)**, 4Mbx32 **(16MB)**,  
8Mbx32 **(32MB)**, 16Mbx32 **(64MB)**.
- (2) SDRAM memory : 1Mbx64 **(8MB)**, 2Mbx64 **(16MB)**,  
4Mbx64 **(32MB)**, 8Mbx64 **(64MB)**,  
16Mbx64 **(128MB)**.

In order to make the mainboard working properly, at least one bank of memory have to be installed on the board. The “BANK” is the definition of the memory subsystem addressing. Please refer to the following for the definition of “BANK”

**BANK0: DIMM 1**  
**BANK1: DIMM 2**  
**BANK2: DIMM 3**

This mainboard supports EDO, FPM and SDRAM types of memory module. When installing memory modules, you don't have to start from Bank0 first. Basically, the memory can be populated on the board in any order and the system board will detect the memory installed on the board automatically.

So you can install a DIMM module onto one of the DIMM sockets and then you may upgrade your system memory by plugging in another DIMM module in one of the rest DIMM sockets afterward and need not to worry about the sequence.

**Note:** You can use either PC-66 or PC-100 DIMM module on this mainboard. In order to make sure that the DIMM module will be working properly on this mainboard, please refer to page 3-22 for the jumper settings of JP7 and JP8.

## 4. AWARD BIOS SETUP

### 4.1 GETTING STARTED

When the system is powered on or reset, the BIOS will execute the Power-On Self Test routines (POST) and checks the functionality of every component in the PC system. During the POST, you will see a copyright message on the screen followed by a diagnostics and initialization procedure. (If an EGA or VGA card is installed, the copyright message of the video card maybe displayed on the screen first.) When the system detects any error, it will gives a series of beeping sounds or display the error message on your screen.

When you have turn on the system, you will see the following display on the system::

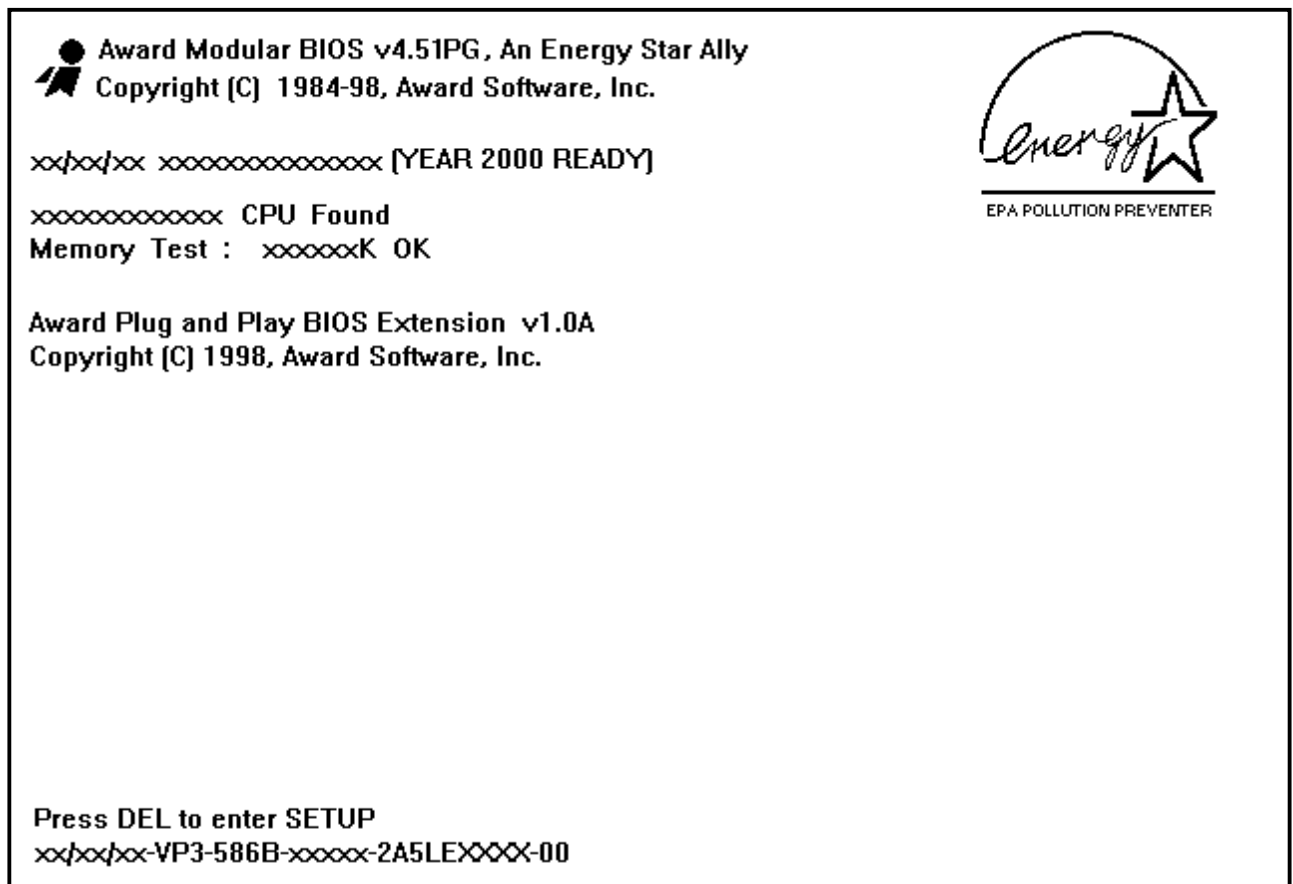

Fig. 4-1 Initial Power-On screen.

When the POST routines are completed, you will find the following message appears on the lower-left screen :

“ Press **DEL** to enter SETUP ”

To execute the Award BIOS Setup program, press the **DEL** key and the “MAIN MENU” of the BIOS setup utility as shown in Fig 4-2 will be triggered.

## 4.2 MAIN MENU

ROM PCI / ISA BIOS (2A5LEXXX)  
 CMOS SETUP UTILITY  
 AWARD SOFTWARE, INC.

<b>STANDARD CMOS SETUP</b>	SUPERVISOR PASSWORD
BIOS FEATURES SETUP	USER PASSWORD
CHIPSET FEATURES SETUP	IDE HDD AUTO DETECTION
POWER MANAGEMENT SETUP	HDD LOW LEVEL FORMAT
PNP/PCI CONFIGURATION	SAVE & EXIT SETUP
INTEGRATED PERIPHERALS	EXIT WITHOUT SAVING
LOAD SETUP DEFAULTS	
ESC : Quit	↑↓←→ : Select Item
F10 : Save & Exit Setup	(Shift)F2 : Change Color
Time, Date, Hard Disk Type ...	

Fig. 4-2 CMOS SETUP MAIN MENU screen.

### 4.3 CONTROL KEYS

Listed below is an explanation of the keys displayed at the bottom of the screens which will be used in the BIOS SETUP program :

- Arrow Keys** : Use the arrow keys to move the cursor to the desired item.
- Enter** : To select the desired item.
- F1** : Display the help screen for the selected feature.
- (Shift)F2** : To change the screen color, total 16 colors.
- ESC** : Exit to the previous screen.
- PgUp(-)/PgDn(+)** : To modify or change the default value of the highlighted item.
- F7** : Loads the SETUP default values from BIOS default table, (only for the current page will be recovered)
- F10** : Save all changes made to CMOS RAM in the MAIN MENU.

The following sections shows all the screens which you will find in the CMOS SETUP routine, each figure contains the setup items and its default settings. At the bottom of some screen display, you may find the description of all function key which you can use it to change the settings. If you are not quite sure of the definition for some specific items, please consult your mainboard supplier for details.

## 4.4 STANDARD CMOS SETUP

ROM PCI / ISA BIOS (2A5LEXXX)  
STANDARD CMOS SETUP  
AWARD SOFTWARE, INC.

Date (mm : dd : yy)	Sat	Jul	4	1998						
Time (hh : mm : ss)	08	:	35	:	45					
HARD DISKS	TYPE	SIZE	CYLS	HEAD	PRECOMP	LANDZ	SECTOR	MODE		
Primary Master	Auto	0	0	0	0	0	0	Auto		
Primary Slave	None	0	0	0	0	0	0	-----		
Secondary Master	Auto	0	0	0	0	0	0	Auto		
Secondary Slave	None	0	0	0	0	0	0	-----		
Drive A	:	1.44M,	3.5 in.							
Drive B	:	None								
Video	:	EGA/VGA								
Halt On	:	All Errors								
						Base Memory	:	640 K		
						Extended Memory	:	xxxxxxx K		
						Other Memory	:	xxxxxxx K		
						Total Memory	:	xxxxxxx K		
ESC	:	Quit		↑↓←→	:	Select Item		PU/PD/+/-	:	Modify
F1	:	Help		(Shift)F2	:	Change Color				

Fig. 4-3 STANDARD CMOS SETUP screen.

### MODE:

The BIOS on the mainboard provides three different modes to support both normal size IDE hard disk drive and the hard disk drive which is above 528MB:

- **NORMAL** : For IDE hard disk drives which is smaller than 528MB.
- **LBA** : For IDE hard disk drive which is above 528MB (ideally, it can be as big as 8.4GB ) that use Logic Block Addressing (LBA) mode.
- **Large** : For IDE hard disks size larger then 528MB but it does not support the LBA mode. (**Note:** Large mode is not fully supported by most operation systems so far. Only MS-DOS is recommended on such hard disk drive. )

*Note* : Some certain operation system (like SCO-UNIX) will have to choose the "NORMAL" mode when installation.

## 4.5 BIOS FEATURES SETUP

ROM PCI / ISA BIOS (2A5LEXXX)

BIOS FEATURES SETUP

AWARD SOFTWARE, INC.

Virus Warning	: Disabled	Video BIOS Shadow	: Enabled
CPU Internal Cache	: Enabled	C8000-CBFFF Shadow	: Disabled
External Cache	: Enabled	CC000-CFFFF Shadow	: Disabled
Quick Power On Self Test	: Enabled	D0000-D3FFF Shadow	: Disabled
Boot Sequence	: A,C,SCSI	D4000-D7FFF Shadow	: Disabled
Swap Floppy Drive	: Disabled	D8000-DBFFF Shadow	: Disabled
Boot Up Floppy Seek	: Enabled	DC000-DFFFF Shadow	: Disabled
Boot Up NumLock Status	: On		
Gate A20 Option	: Normal		
Memory Parity/ECC Check	: Enabled		
Typematic Rate Setting	: Disabled		
Typematic Rate (Chars/Sec)	: 6		
Typematic Rate (Msec)	: 250		
Security Option	: Setup	ESC	: Quit ↑↓←→ :Select Item
PS/2 mouse function control	: Enabled	F1	: Help PU/PD/+/- :Modify
PCI/VGA Palette Snoop	: Disabled	F5	: Old Values (Shift)F2 : Color
OS Select For DRAM > 64MB	: Non-OS2	F7	: Load Setup Defaults

Fig. 4-4 BIOS FEATURES SETUP screen.

**Virus Warning**

When this item is enabled, the system BIOS will monitor the boot sector and partition table of the hard disk drive for any attempt of modification. If an attempt is detected, the BIOS will halt the system and the following error message will appear. When you find such message, please run an anti-virus program to locate and remove the.

! WARNING !  
 Disk boot sector is to be modified  
 Type "Y" to accept write or "N" to  
 abort write  
 Award Software, Inc.

Enabled	Activates automatically when the system boots up causing a warning message to appear when anything attempts to access the boot sector or hard disk partition table.
Disabled	No warning message will appear when anything attempts to access the boot sector or hard disk partition table.

**NOTE:** Many disk diagnostic programs which attempt to access the boot sector table can cause the above warning message. If you will be running such a program, we recommend that you first disable Virus Protection beforehand.

### CPU Internal /External Cache

These two categories allow you to enable or disable the cache memory on the CPU to speed up memory access. The default value is enabled.

### Quick Power On Self Test

This category speeds up Power On Self Test (POST) after you power up the computer. If it is set to Enable, the system BIOS will shorten or skip some check items during POST.

Enabled	Enable quick POST
Disabled	Normal POST

### Boot Sequence

This category determines which drive to search first for the disk operating system (i.e., DOS). The options available are "A,C,SCSI", "C,A,SCSI", "C,CDROM,A", "CDROM,C,A", "D,A,SCSI", "E,A,SCSI", "F,A,SCSI", "SCSI,A,C", "SCSI,C,A", "C only" and "LS/ZIP,C". Default value is A,C,SCSI.

When select to load the OS from "CDROM,C,A" or "LS/ZIP,C", you must select the "HARD DISK TYPE and MODE" properly, the "Auto" selection is recommended so that you can use CDROM or LS/ZIP device to load the OS into your system. (You can find these items in the "STANDARD CMOS SETUP" )

### Swap Floppy Drive

This item allows you to determine whether enable the swap floppy drive or not. The choice: Enabled/Disabled.

**Boot Up Floppy Seek**

During POST, BIOS will determine if the floppy disk drive installed is 40 or 80 tracks. 360K type is 40 tracks while 720K, 1.2M and 1.44M are all 80 tracks.

Enabled	BIOS searches for floppy disk drive to determine if it is 40 or 80 tracks. Note that BIOS can not tell from 720K, 1.2M or 1.44M drive type as they are all 80 tracks.
Disabled	BIOS will not search for the type of floppy disk drive by track number. Note that there will not be any warning message if the drive installed is 360K.

**Boot Up NumLock Status**

This allows you to determine the default state of the numeric keypad. By default, the system boots up with NumLock on.

On	Keypad is number keys
Off	Keypad is arrow keys

**Boot Up System Speed**

Selects the default system speed -- the normal operating speed at power up.

High	Set the speed to high
Low	Set the speed to low

**Gate A20 Option**

This entry allows you to select how the gate A20 is handled. The gate A20 is a device used to address memory above 1 Mbytes. Initially, the gate A20 was handled via a pin on the keyboard. Today, while keyboards still provide this support, it is more common, and much faster, for the system chipset to provide support for gate A20.

Normal	keyboard
Fast	chipset

**Typematic Rate Setting**

This determines if the typematic rate is to be used. When disabled, continually holding down a key on your keyboard will generate only one instance. In other words, the BIOS will only report that the key is down. When the typematic rate is enabled, the BIOS will report as before, but it will then wait a moment, and, if the key is still down, it will begin the report that the key has been depressed repeatedly. For example, you would use such a feature to accelerate cursor movements with the arrow keys.

Enabled	Enable typematic rate
Disabled	Disable typematic rate

**Typematic Rate (Chars/Sec)**

When the typematic rate is enabled, this selection allows you select the rate at which the keys are accelerated.

6	6 characters per second
8	8 characters per second
10	10 characters per second
12	12 characters per second
15	15 characters per second
20	20 characters per second
24	24 characters per second
30	30 characters per second

**Typematic Delay (Msec)**

When the typematic rate is enabled, this selection allows you to select the delay between when the key was first depressed and when the acceleration begins.

250	250 msec
500	500 msec
750	750 msec
1000	1000 msec

**Security Option**

This category allows you to limit access to the system and Setup, or just to Setup

System	The system will not boot and access to Setup will be denied if the correct password is not entered at the prompt.
Setup	The system will boot, but access to Setup will be denied if the correct password is not entered at the prompt.

**Note:** To disable security, select PASSWORD SETTING at Main Menu and then you will be asked to enter password. Do not type anything and just press <Enter>, it will disable security. Once the security is disabled, the system will boot and you can enter Setup freely.

**PCI / VGA Palette Snoop**

It determines whether the MPEG ISA/VESA VGA Cards can work with PCI/VGA or not.

Enabled	When PCI/VGA working with MPEG ISA/VESA VGA Card.
Disabled	When PCI/VGA not working with MPEG ISA/VESA VGA Card.

**OS Select for DRAM > 64**

This item allows you to access the memory that over 64MB in OS/2.  
The choice: Non-OS2, OS2.

**Video BIOS Shadow**

Determines whether video BIOS will be copied to RAM. However, it is optional depending on chipset design. Video Shadow will increase the video speed.

Enabled	Video shadow is enabled
Disabled	Video shadow is disabled

**C8000 - CBFFF Shadow/DC000 - DFFFF Shadow**

These categories determine whether option ROMs will be copied to RAM. An example of such option ROM would be support of on-board SCSI.

Enabled	Optional shadow is enabled
Disabled	Optional shadow is disabled

## 4.6 CHIPSET FEATURES SETUP

ROM PCI / ISA BIOS (2A5LEXXX)

CMOS SETUP UTILITY

CHIPSET FEATURES SETUP

Bank 0/1 DRAM Timing	: SDRAM 10ns	OnChip USB	: Enabled
Bank 2/3 DRAM Timing	: FP/EDO 70ns	USB Keyboard Support	: Disabled
Bank 4/5 DRAM Timing	: FP/EDO 70ns		
SDRAM Cycle Length	: 3	Auto Detect DIMM/PCI CLK	: Enabled
DRAM Read Pipeline	: Enabled	Spread Spectrum	: Disabled
Cache Rd+CPU Wt Pipeline	: Enabled		
Cache Timing	: Fast		
Video BIOS Cacheable	: Enabled		
System BIOS Cacheable	: Enabled		
Memory Hole At 15Mb Addr.	: Disabled		
AGP Aperture Size	: 64M		
		ESC : Quit	↑↓←→ : Select Item
		F1 : Help	PU/PD/+/- : Modify
		F5 : Old Values	(Shift)F2 : Color
		F7 : Load Setup Defaults	

Fig. 4-5 CHIPSET FEATURES SETUP screen.

**WARNING :** *The selection fields on this screen are provided for the professional technician who can modify the Chipset features to meet some specific requirement. If you do not have the related technical background, do not attempt to make any change except the following items.*

This section allows you to configure the system based on the specific features of the installed chipset. This chipset manages bus speeds and access to system memory resources, such as DRAM and the external cache. It also coordinates communications between the conventional ISA bus and the PCI bus. It must be stated that these items should never need to be altered. The default settings have been chosen because they provide the best operating conditions for your system. The only time you might consider making any changes would be if you discovered that data was being lost while using your system.

**Bank 0/1 ( 2/3, 4/5)DRAM Timing :**

BANK 0/1: DIMM1

BANK 2/3: DIMM2

BANK 4/5: DIMM3

The memory modules inserted onto the mainboard will be detected by the system BIOS automatically. For example, when you insert a SDRAM module onto DIMM1, DIMM2 or DIMM3, "SDRAM 10ns" will be displayed on the screen shown above. (It will be "FP/EDO 70ns" when SDRAM module is absent on the DIMM subsystem.) There are two optimum values suggested for the chipset and CPU registers. As for SDRAM modules, "10ns" is suggested for most modules. "8ns" will let you have better performance, but it may cause system unstable when SDRAM modules are not fast enough.

**SDRAM Cycle Length**

This field sets the CAS latency timing.

The Choice: 2, 3.

**DRAM Read Pipeline**

You may select *Enabled* for this field when PDSRAMs are installed. Pipelining improves system performance.

The Choice: Enabled, Disabled.

**Cache Rd+CPU Wt Pipeline**

This item allows you to enable/disable the cache timing.

The Choice: Enabled, Disabled.

**Video BIOS Cacheable**

When enabled. The Video BIOS cache will cause access to video BIOS addressed at C0000H to C7FFFH to be cached, if the cache controller is also enabled

The Choice: Enabled, Disabled.

**System BIOS Cacheable**

As with caching the Video BIOS above, enabling this selection allows accesses to the system BIOS ROM addressed at F0000H-FFFFFFH to be cached, provided that the cache controller is enabled.

The Choice: Enabled, Disabled.

**Memory Hole At 15Mb Addr**

In order to improve performance, certain space in memory is reserved for ISA cards. This memory must be mapped into the memory space below 16MB.

The Choice: Disabled, 15M-16M, 14M-16M.

**AGP Aperture Size**

Select the size of Accelerated Graphics Port (AGP) aperture. The aperture is a portion of the PCI memory address range dedicated for graphics memory address space. Host cycles that hit the aperture range are forwarded to the AGP without any translation. See [www.apgforum.org](http://www.apgforum.org) for AGP information.

The Choice: 4M, 8M, 16M, 32M, 65M, 128M, 256M.

**OnChip USB**

Select Enabled if your system contains a Universal Serial Bus (USB) controller and you have a USB peripheral.

The Choice: Enabled, Disabled.

**USB Keyboard Support**

Select Enabled if your system contains a Universal Serial Bus (USB) controller and you have a USB keyboard.

The Choice: Enabled, Disabled.

## 4.7 POWER MANAGEMENT SETUP

ROM PCI / ISA BIOS (2A5LEXXX)  
 POWER MANAGEMENT SETUP  
 AWARD SOFTWARE, INC.

Power Management	: User Define	Primary INTR	: ON
PM Control by APM	: Yes	IRQ3 (COM2)	: Primary
Video Off Option	: Suspend->Off	IRQ4 (COM1)	: Primary
Video Off Method	: Blank Screen	IRQ5 (LPT2)	: Primary
MODEM Use IRQ	: 3	IRQ6 (Floppy Disk)	: Primary
Soft-Off by PWRBTN	: Instant-Off	IRQ7 (LPT1)	: Primary
** PM Timers **		IRQ8 (RTC Alarm)	: Disabled
HDD Power Down	: Disabled	IRQ9 (IRQ2 Redir)	: Secondary
Doze Mode	: Disabled	IRQ10 (Reserved)	: Secondary
Suspend Mode	: Disabled	IRQ11 (Reserved)	: Secondary
** PM Events **		IRQ12 (PS/2 Mouse)	: Primary
VGA	: OFF	IRQ13 (Coprocessor)	: Primary
LPT & COM	: LPT/COM	IRQ14 (Hard Disk)	: Primary
HDD & FDD	: ON	IRQ15 (Reserved)	: Disabled
DMA/master	: OFF	ESC : Quit	↑↓←→ : Select Item
Modem or LAN Resume	: Disabled	F1 : Help	PU/PD/+/- : Modify
RTC Alarm Resume	: Disabled	F5 : Old Values (Shift)	F2 : Color
		F7 : Load Setup Defaults	

Fig. 4-6 POWER MANAGEMENT SETUP screen.

**WARNING :** *The selection fields on this screen are provided for the professional technician who can modify the Chipset features to meet some specific requirement. If you do not have the related technical background, do not attempt to make any change except the following items.*

### Power Management

This category allows you to select the type (or degree) of power saving and is directly related to the following modes:

1. Doze Mode
2. Suspend Mode
3. HDD Power Down

There are four selections for Power Management, three of which have fixed mode settings.

Disable (default)	No power management. Disables all four modes
Min. Power Saving	Minimum power management. Doze Mode = 1 hr. Standby Mode = 1 hr., Suspend Mode = 1 hr., HDD Power Down = 15 min.
Max. Power Saving	Maximum power management -- <b>ONLY AVAILABLE FOR SL CPU'S.</b> Doze Mode = 1 min., Standby Mode = 1 min., Suspend Mode = 1 min., HDD Power Down = 1 min.
User Defined	Allows you to set each mode individually. When not disabled, each of the ranges are from 1 min. to 1 hr. except for HDD Power Down which ranges from 1 min. to 15 min. and disable.

### PM Control APM

When enabled, an Advanced Power Management device will be activated to enhance the Max. Power Saving mode and stop the CPU internal clock. If Advance Power Management (APM) is installed on your system, selecting Yes gives better power savings.

If the Max. Power Saving is not enabled, this will be preset to *No*.

**Video Off Option**

When enabled, this feature allows the VGA adapter to operate in a power saving mode.

Always On	Monitor will remain on during power saving modes.
Suspend --> Off	Monitor blanked when the systems enters the Suspend mode.
Susp,Stby --> Off	Monitor blanked when the system enters either Suspend or Standby modes.
All Modes --> Off	Monitor blanked when the system enters any power saving mode.

**Video Off Method**

This determines the manner in which the monitor is blanked.

V/H SYNC+Blank	This selection will cause the system to turn off the vertical and horizontal synchronization ports and write blanks to the video buffer.
Blank Screen	This option only writes blanks to the video buffer.
DPMS	Select this option if your monitor supports the Display Power Management Signaling (DPMS) standard of the Video Electronics Standards to select video power management values.

**MODEM Use IRQ**

This determines the IRQ in which the MODEM can use.

The choice: 1, 3, 4, 5, 7, 9, 10, 11, NA.

**Soft-Off by PWRBTN**

When Enabled, turning the system off with the on/off button places the system in a very low-power-usage state, with only enough circuitry receiving power to detect power button activity or Resume by Ring activity.

The choice: Delay 4 Sec, Instant Off.

---

### PM Timers

---

The following four modes are Green PC power saving functions which are only user configurable when *User Defined* Power Management has been selected. See above for available selections.

#### HDD Power Down

When enabled and after the set time of system inactivity, the hard disk drive will be powered down while all other devices remain active.

#### Doze Mode

When enabled and after the set time of system inactivity, the CPU clock will run at slower speed while all other devices still operate at full speed

#### Suspend Mode

When enabled and after the set time of system inactivity, all devices except the CPU will be shut off.

---

### \*\* PM Events \*\*

---

PM events are I/O events whose occurrence can prevent the system from entering a power saving mode or can awaken the system from such a mode. In effect, the system remains alert for anything which occurs to a device which is configured as *On*, even when the system is in a power down mode.

#### VGA

When set to *On* (default), any event occurring at a VGA port will awaken a system which has been powered down.

#### LPT & COM

When set to LPT/COM, any event occurring at a COM(serial)/LPT (printer) port will awaken a system which has been powered down.

#### HDD & FDD

When set to *On* (default), any event occurring at a hard or floppy drive port will awaken a system which has been powered down.

#### DMA/master

When set to *On* (default:Off), any event occurring to the DMA controller will awaken a system which has been powered down.

---

**Modem or LAN Resume**

When set to *Enabled* , any event occurring to the Modem Ring will awaken a system which has been powered down.

**RTC Alarm Resume**

When set to *Enable RTA Alarm Resume*, you could set the date (of month) and timer (hh:mm:ss), any event occurring at will awaken a system which has been powered down.

**Primary INTR**

When set to *On* (default), any event occurring at will awaken a system which has been powered down.

The following is a list of IRQ's, **I**nterrupt **ReQ**uests, which can be exempted much as the COM ports and LPT ports above can. When an I/O device wants to gain the attention of the operating system, it signals this by causing an IRQ to occur. When the operating system is ready to respond to the request, it interrupts itself and performs the service. As above, the choices are *On* and *Off*. *On* is the default.

When set *On*, activity will neither prevent the system from going into a power management mode nor awaken it.

- **IRQ3 (COM 2 )**
- **IRQ4 (COM 1)**
- **IRQ5 (LPT 2)**
- **IRQ6 (Floppy Disk)**
- **IRQ7 (LPT 1)**
- **IRQ8 (RTC Alarm)**
- **IRQ9 (IRQ2 Redir)**
- **IRQ10 (Reserved)**
- **IRQ11 (Reserved)**
- **IRQ12 ( PS / 2 Mouse )**
- **IRQ13 (Coprocessor)**
- **IRQ14 (Reserved)**
- **IRQ15 (Reserved)**

## 4.8 PNP/PCI CONFIGURATION

ROM PCI / ISA BIOS (2A5LEXXX)

INTEGRATED PERIPHERALS

AWARD SOFTWARE, INC.

PNP OS Installed : <b>No</b>	CPU to PCI Write Buffer : Enabled
Resources Controlled By : Manual	PCI Dynamic Bursting : Enabled
Reset Configuration Data : Disabled	PCI Master 0 WS Write : Enabled
	PCI Delay Transaction : Enabled
IRQ-3 assigned to : PCI/ISA PnP	PCI Master Read Prefetch : Enabled
IRQ-4 assigned to : PCI/ISA PnP	PCI #2 Access #1 Retry : Disabled
IRQ-5 assigned to : PCI/ISA PnP	AGP Master 1 WS Write : Enabled
IRQ-7 assigned to : PCI/ISA PnP	AGP Master 1 WS Read : Disabled
IRQ-9 assigned to : PCI/ISA PnP	
IRQ-10 assigned to : PCI/ISA PnP	PCI IRQ Actived By : Level
IRQ-11 assigned to : PCI/ISA PnP	Assign IRQ For USB : Enabled
IRQ-12 assigned to : PCI/ISA PnP	Assign IRQ For VGA : Enabled
IRQ-14 assigned to : PCI/ISA PnP	
IRQ-15 assigned to : PCI/ISA PnP	
DMA-0 assigned to : PCI/ISA PnP	
DMA-1 assigned to : PCI/ISA PnP	ESC : Quit    ↑↓←→ : Select Item
DMA-3 assigned to : PCI/ISA PnP	F1 : Help    PU/PD/+/- : Modify
DMA-5 assigned to : PCI/ISA PnP	F5 : Old Values    (Shift)F2 : Color
DMA-6 assigned to : PCI/ISA PnP	F7 : Load Setup Defaults
DMA-7 assigned to : PCI/ISA PnP	

Fig. 4-7 PNP/PCI CONFIGURATION setup screen.

**WARNING** : The selection fields on this screen are provided for the professional technician who can modify the Chipset features to meet some specific requirement. If you do not have the related technical background, do not attempt to make any change except the following items.

**PNP OS Installed**

Select Yes if the system operating environment is Plug-and-Play aware (e.g., Windows 95).

The Choice: Yes and No.

**Resource controlled by**

The Award Plug and Play BIOS has the capacity to automatically configure all of the boot and Plug and Play compatible devices. However, this capability means absolutely nothing unless you are using a Plug and Play operating system such as Windows®95.

The choice: Auto and Manual.

**Reset Configuration Data**

Normally, you leave this field Disabled. Select Enabled to reset Extended System Configuration Data (ESCD) when you exit Setup if you have installed a new add-on and the system reconfiguration has caused such a serious conflict that the operating system can not boot.

The choice: Enabled and Disabled .

**IRQ3/4/5/7/9/10/11/12/14/15 assigned to,**

When resources are controlled manually, assign each system interrupt as one of the following types, depending on the type of device using the interrupt:

Legacy ISA Devices compliant with the original PC AT bus specification, requiring a specific interrupt ( such as IRQ4 for serial port 1). PCI/ISA PnP Devices compliant with the Plug and Play standard, whether designed for PCI or ISA bus architecture.

The choice: Legacy ISA and PCI/ISA PnP.

**DMA0/1/3/5/6/7 assigned to**

When resources are controlled manually, assign each system DMA channel as one of the following types, depending on the type of device using the interrupt:

Legacy ISA Devices compliant with the original PC AT bus specification, requiring a specific interrupt ( such as IRQ4 for serial port 1). PCI/ISA PnP Devices compliant with the Plug and Play standard, whether designed for PCI or ISA bus architecture.

The choice: Legacy ISA and PCI/ISA PnP.

**CPU to PCI Write Buffer**

When enabled, up to four D words of data can be written to the PCI bus without interrupting the CPU. When disabled, a write buffer is not used and the CPU read cycle will not be completed until the PCI bus signals that it is ready to receive the data..

The choice: Enabled, Disabled.

**PCI Dynamic Bursting**

When Enabled, data transfers on the PCI bus, where possible, make use of the high-performance PCI burst protocol, in which greater amounts of data are transferred at a single command..

The choice: Enabled, Disabled.

**PCI Master 0 WS Write**

When Enabled, writes to the PCI bus are command with zero wait states.

The choice: Enabled, Disabled.

**PCI Delay Transaction**

The chipset has an embedded 32-bit posted write buffer to support delay transactions cycles. Select Enabled to support compliance with PCI specification version 2.1.

The choice: Enabled, Disabled.

**PCI Master Read Prefetch**

This item allows you enable/disable the PCI Master Read Prefetch.

The choice: Enabled, Disabled.

**PCI #2 Access #1 Retry**

This item allows you enable/disable the PCI #2 Access #1 Retry.

The choice: Enabled, Disabled.

**PCI Master 1 WS Write**

This implements a single delay when writing to the PCI Bus. By default, two-wait states are used by the system, allowing for greater stability.

The choice: Enabled, Disabled.

**PCI Master 1 WS Read**

This implements a single delay when reading to the PCI Bus. By default, two-wait states are used by the system, allowing for greater stability.

The choice: Enabled, Disabled.

## 4.9 INTEGRATED PERIPHERALS

ROM PCI / ISA BIOS (2A5LEXXX)

INTEGRATED PERIPHERALS

AWARD SOFTWARE, INC.

On-Chip IDE First Channel	: Enabled	Onboard Parallel Port	: 378 / IRQ 7
On-Chip IDE Second Channel	: Enabled	Onboard Parallel Mode	: SPP
IDE Prefetch Mode	: Enabled		
IDE HDD Block Mode	: Enabled		
IDE Primary Master PIO	: Auto		
IDE Primary Slave PIO	: Auto		
IDE Secondary Master PIO	: Auto		
IDE Secondary Slave PIO	: Auto		
IDE Primary Master UDMA	: Auto		
IDE Primary Slave UDMA	: Auto		
IDE Secondary Master UDMA	: Auto		
IDE Secondary Slave UDMA	: Auto		
Init AGP Display First	: PCI Slot		
Onboard FDC Controller	: Enabled		
Onboard Serial Port 1	: 3F8 / IRQ 4	ESC : Quit	↑↓←→ : Select Item
Onboard Serial Port 2	: 2F8 / IRQ 3	F1 : Help	PU/PD/+/- : Modify
UART 2 Mode	: Standard	F5 : Old Values	(Shift)F2 : Color
		F7 : Load Setup Defaults	

Fig. 4-8 INTEGRATED PERIPHERALS setup screen.

### OnChip IDE First Channel

This chipset contains a PCI IDE interface with support for two IDE channels. Select Enabled to activate the first and/or second IDE interface. Select Disabled to deactivate this interface, if you install a first and/or second add-in IDE interface IDE interface.

Enabled	First HDD controller used – Default
Disabled	First HDD controller not used.

**OnChip IDE Second Channel**

This chipset contains a PCI IDE interface with support for two IDE channels. Select Enabled to activate the first and/or second IDE interface. Select Disabled to deactivate this interface, if you install a first and/or second add-in IDE interface IDE interface.

Enabled	Second HDD controller used
Disabled	Second HDD controller not used.

**IDE Prefetch Mode**

Enable prefetching for IDE drive interfaces that support its faster drive accesses. If you are getting disk drive errors, change the setting to omit the drive interface where the errors occur. Depending on the configuration of your IDE subsystem, this field may not appear, and it does not appear when the Internal PCI/IDE field, above, is Disabled.

The choice: Enabled, Disabled.

**IDE HDD Block Mode**

This item allows your hard disk controller to use the fast block mode to transfer data to and from your hard disk drive (HDD). Select Enabled only if your hard drives support block mode.

Enabled	IDE controller uses block mode.
Disabled	IDE controller uses standard mode.

**IDE Primary/Secondary Master/Slave PIO**

The four IDE PIO (Programmed Input/Output) fields let you set a PIO mode (0-4) for each of the four IDE devices that the onboard IDE interface supports. Modes 0 through 4 provide successively increased performance. In Auto mode, the system automatically determines the best mode for each device.

**IDE Primary/Secondary Master/Slave UDMA**

Ultra DMA/33 implementation is possible only if your IDE hard drive supports it and the operating environment includes a DMA driver (Windows 95 OSR2 or a third-party IDE bus master driver). If your hard drive and your system software both support Ultra DMA/33, select Auto to enable BIOS support.

The Choice: Auto, Disabled

**Onboard FDC Controller**

This should be enabled if your system has a floppy disk drive (FDD) installed on the system board and you wish to use it. Even when so equipped, if you add a higher performance controller, you will need to disable this feature.

The choice: Enabled, Disabled.

**Onboard Serial Port 1/Port 2**

This item allows you to determine access onboard serial port 1/port 2 controller with which I/O address.

The choice: 3F8/IRQ4, 2E8/IRQ3, 3E8/IRQ4, 2F8/IRQ3, Disabled.

**UART 2 Mode**

This item allows you to determine which Infra Red (IR) function (CN10) of onboard I/O chip.

The choice: Standard, ASKIR, HPSIR

**Onboard Parallel Port**

This item allows you to determine access onboard parallel port controller with which I/O address.

The choice: 378/IRQ7, 278/IRQ5, 3BC/IRQ7, Disabled.

**Onboard Parallel Mode**

Select an operating mode for the onboard parallel (printer) port. Normal EPP (Extended Parallel Port), ECP (Extended Capabilities Port) ECP+EPP PC AT parallel port Bi-directional port Fast, buffered port Fast, buffered, bi-directional port. Select Normal unless you are certain your hardware and software both support EPP or ECP mode.

The choice: SPP, ECP/EPP, ECP, EPP/SPP.

## 4.10 LOAD SETUP DEFAULTS

ROM PCI / ISA BIOS (2A5LEXXX)  
 INTEGRATED PERIPHERALS  
 AWARD SOFTWARE, INC.

STANDARD CMOS SETUP	SUPERVISOR PASSWORD
BIOS FEATURES SETUP	USER PASSWORD
CHIPSET FEATURES SETUP	IDE HDD AUTO DETECTION
POWER MANAGEMENT SETUP	HDD LOW LEVEL FORMAT
INTEGRATED PERIPHERALS	SAVE & EXIT SETUP
PNP/PCI CONFIGURATION	EXIT WITHOUT SAVING
<b>LOAD SETUP DEFAULTS</b>	
ESC : Quit	<input type="checkbox"/> <input type="checkbox"/> <input type="checkbox"/> <input type="checkbox"/> : Select Item
F10 : Save & Exit Setup	(Shift)F2 : Change Color
	Time, Date, Hard Disk Type ...

If you lost the CMOS data or you don't know how to complete the setup procedure, you may use this option to load the SETUP default values from the BIOS default table. It is easy to load the default value, simply highlight the "LOAD SETUP DEFAULTS" field and then press the "Enter" key, when you see the "LOAD SETUP DEFAULTS (Y/N)" displayed on the screen, response to it with "Y" and then press the "Enter" key. The SETUP default values will be loaded. Basically, the SETUP default settings are the best-case values that will optimize system performance and increase system stability.

In case that the CMOS data is corrupted, the SETUP DEFAULTS settings will be loaded automatically when you press the "Del" key and enter the main setup screen. So you may select "SAVE & EXIT SETUP" to leave setup program and the system is loaded with the default settings.

## 4.11 SUPERVISOR PASSWORD / USER PASSWORD

ROM PCI / ISA BIOS (2A5LEXXX)  
 INTEGRATED PERIPHERALS  
 AWARD SOFTWARE, INC.

STANDARD CMOS SETUP	<b>SUPERVISOR PASSWORD</b>
BIOS FEATURES SETUP	USER PASSWORD
CHIPSET FEATURES SETUP	IDE HDD AUTO DETECTION
POWER MANAGEMENT SETUP	HDD LOW LEVEL FORMAT
INTEGRATED PERIPHERALS	SAVE & EXIT SETUP
PNP/PCI CONFIGURATION	EXIT WITHOUT SAVING
LOAD SETUP DEFAULTS	
ESC : Quit	<input type="checkbox"/> <input type="checkbox"/> <input type="checkbox"/> <input type="checkbox"/> : Select Item
F10 : Save & Exit Setup	(Shift)F2 : Change Color
	Time, Date, Hard Disk Type ...

The “SUPERVISOR PASSWORD” and “USER PASSWORD” will be used to check the authority when power-on. Whenever there is the password stored in either of these fields, the correct password will be requested so that the PC system will continue to load the operation system.

You can enter up to eight alphanumeric characters here. When you have typed in the password and pressed the “Enter” key, you will be asked to reconfirm your password again to complete password setup. If you press the “Enter” key twice without any alphanumeric character entered, the PASSWORD will be disabled.

If the “User Password” and the “Supervisor Password” are both enabled and they have different password setup, “Supervisor Password” is always has the higher priority, Basically, an “User” is only authorized to change the content of “User Password”, while a “Supervisor” has the authorization to dominate all settings.

## 4.12 IDE HDD AUTO DETECTION

ROM PCI / ISA BIOS (2A5LEXXX)









