

633X
Pentium !!!
Celeron
Socket 370
ATX MAINBOARD
(VER. 1.x)

USER'S MANUAL

TABLE OF CONTENTS

Chapter & Section	Page
1. INTRODUCTION	1-1
1.1 OVERVIEW	1-1
1.2 MAINBOARD LAYOUT	1-3
1.3 SPECIFICATIONS	1-4
2. INSTALLATION	2-1
2.1 UNPACKING	2-1
2.2 QUICK INSTALLATION.....	2-2
2.3 AMAZING WAYS TO POWER ON THE PC SYSTEM.....	2-3
2.4 POWER OFF THE PC SYSTEM.....	2-4
3. HARDWARE SETUP	3-1
3.1 INSTALLATION OF CPU	3-1
3.2 INSTALL THE DRAM MODULES	3-2
3.3 CONNECTORS	3-3
3.4 JUMPERS	3-15
3.5 INSTALLATION OF DEVICE DRIVERS.....	3-19
4. AWARD BIOS SETUP	4-1
4.1 GETTING STARTED	4-1
4.2 CONTROL KEYS.....	4-1
4.3 MAIN MENU.....	4-2
4.4 STANDARD CMOS SETUP.....	4-3
4.5 ADVANCED BIOS FEATURES	4-4
4.6 ADVANCED CHIPSET FEATURES	4-7
4.7 INTEGRATED PERIPHERALS	4-11
4.8 POWER MANAGEMENT SETUP.....	4-14
4.9 PNP/PCI CONFIGURATION	4-19
4.10 PC HEALTH STATUS.....	4-21
4.11 FREQUENCY/VOLTAGE CONTROL	4-22
4.12 LOAD OPTIMIZED DEFAULTS.....	4-24
4.13 SET SUPERVISOR PASSWORD.....	4-25
4.14 SET USER PASSWORD	4-26
4.15 SAVE & EXIT SETUP / EXIT WITHOUT SAVING	4-28
5. HOW TO UPDATE THE SYSTEM BIOS.....	5-1

SOMETHING IMPORTANT !

☆ **TRADEMARKS**

All trademarks used in this manual are the property of their respective owners.

☆ **LOAD OPTIMIZED DEFAULTS**

“LOAD OPTIMIZED DEFAULTS” is the function which will have the BIOS default settings loaded into the CMOS memory, these default settings are the best-case values which will optimize system performance and increase system stability. This function will be necessitated when you receive this mainboard, or when the system CMOS data is corrupted. Please refer to the Section 4.12 for the procedures.

☆ **DISCHARGE CMOS DATA**

Whenever you want to discharge the CMOS data or open the system chassis to add or remove any component from the mainboard, make sure to disconnect the AC power first because there is always the 5V standby voltage connected to the ATX form-factor mainboard. Without disconnecting the AC power connector from the PC system, the mainboard can be damaged by any improper action .

☆ **WAKE ON LAN**

In order to support the Wake On LAN feature, the system requires a special SPS (Switching Power Supply), Such power supply must be able to provide at least 700 mA of driving capability on the “5V standby” voltage. Please refer to the Section 3.3 for pin assignment.

☆ **WARNING !**

The "Static Electricity" may cause damage to the components on the mainboard, In order to avoid the damage to the mainboard accidentally, please discharge all static electricity from your body before touching this mainboard.

☆ **NOTICE**

Information presented in this manual has been carefully checked for reliability; however, no responsibility is assumed for inaccuracies. The information contained in this manual is subject to change without notice.

IMPORTANT NOTICE !!!

This mainboard provides the flexible design that allows you to fine tune the CPU core voltage and front side bus frequency. However, we do not give guarantee on over clocking because there are many factors which will give different result. Please consult with an experienced technician before you start the CPU over clocking.

1. INTRODUCTION

1.1 OVERVIEW

This Mainboard is a revolutionary high performance personal computer mainboard. It is the ATX form-factor with the Socket 370 CPU connector designed on the board for the Pentium™ !!! and Celeron™ processors. VIA VT8633 and VT8233 chipsets are chosen as the system core logic of the mainboard to give the most outstanding performance and reliability. VIA PRO266 is the energy efficient chipset and it supports the system front side bus speed from 66MHz, 100MHz to 133MHz for various Celeron™ and Pentium™ !!! processors

VIA VT8233 is a high integration, high integration, power-efficient and high compatibility device which supports Intel and non-Intel processors to PCI bridge functionality to make a complete PC99-compliant PCI system.

In order to give higher system speed and reliable stability, additional Vcore and Front Side Bus (FSB) speed adjustment is introduced on the mainboard. Users may use such functions to fine tune the CPU core voltage and FSB speed so that the PC system can be running at higher speed with reliable compatibility.

There is the full featured AGP (Accelerated Graphics Port) slot designed on the mainboard which supports the 4X AGP mode. When you have the AGP display card which support the 4X display mode, it will enhance the system display performance. There is also the 3D audio interface integrated on the mainboard. So you do not have to invest any on the audio interface card. Simply have the speaker connected to the audio connector (CN18) on the mainboard and you will have the 3D sound effect in your PC system.

What is Socket 370?

Basically, Socket 370 is the CPU connector designed for the socket type of Pentium™ !!! and Celeron™ processors. The Socket 370 processor is designed for the value PC with outstanding performance. With the Socket type of Pentium™ !!! and Celeron™ processors installed on the mainboard, you will get a PC capable of running today's applications with ease, and with enough power to run the applications of tomorrow

Accelerated Graphic Port (AGP)

There is the AGP slot built on the board where you can install the AGP VGA card. Basically, the demand for 3D graphic rendering and the throughput of screen display is increasing. AGP is such a new interface that will increase massive bandwidth between VGA card and CPU to increase the display quality and performance. The AGP slot designed on the mainboard supports the 4X AGP mode. When you have the 4X AGP display card installed on the mainboard, it will enhance the system display performance tremendously.

Over Clocking

This mainboard allows you to fine tune the CPU core voltage (Vcore) and Front Side Bus clock (FSB). When users decide to increase the system performance by over clocking the CPU, they will have to change the FSB clock speed and the Vcore to achieve such purpose. This mainboard provides a flexible selection on FSB clock and Vcore and it allows you to optimize the system performance and stability when over clocking. (please refer to Section 4-11 for the settings).

Hardware Monitoring

There is the hardware monitoring designed on the mainboard. You can always use the hardware monitoring feature to monitor the system healthy status. Basically, the hardware monitoring feature will monitor the status of the cooling fan speed, CPU voltage and system temperature etc.

There is also the 3D audio interface designed on the mainboard. When the audio interface is installed on the mainboard, you need not to invest any on the audio interface card. Simply have the speaker connected to the audio connector (CN18) on the mainboard and you will have the 3D sound effect in your PC system.

According to different logic applied on this mainboard, several different model will be created as shown in the following table: Please refer to the following table for the difference:

MODEL NAME			
633X-AS			
633X-AD			

1.2 MAINBOARD LAYOUT

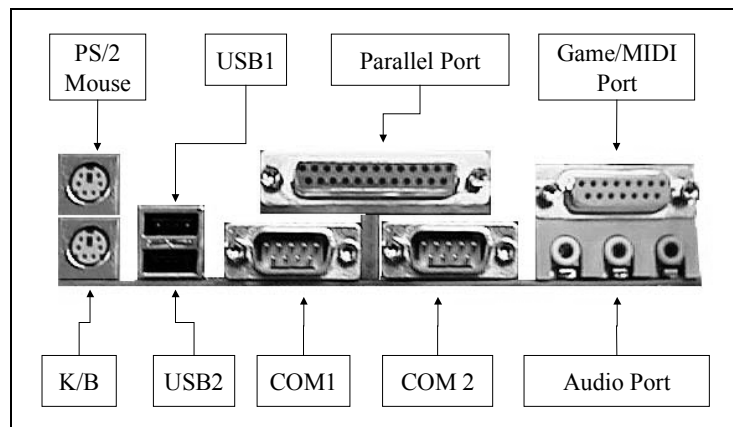
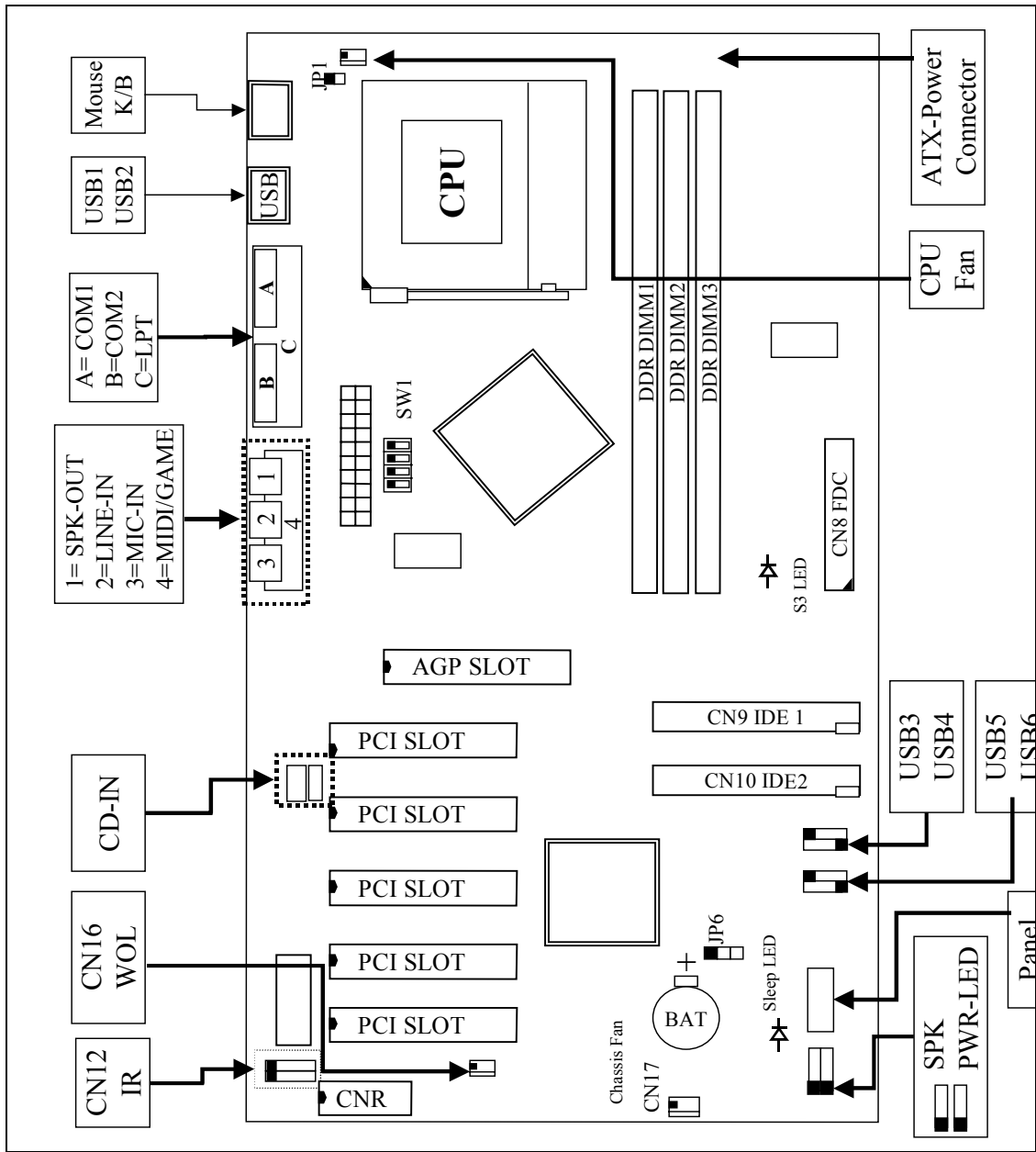

1.3 SPECIFICATIONS

⊙ CPU

Intel® Socket 370 Pentium™ !!! or Celeron™ 500, 533, 550, 600, ,650, 667, 700, 733, ,750, 766, 800, 866, 900, 933MHz and upto1GHz high speed processors

⊙ CPU VCC

Switching Voltage Regulator circuits on board, supports +1.30V DC through +2.05V DC CPU Core Voltage.

Note : The CPU Core Voltage can be fine tuned by the BIOS setup program to give higher speed and reliability.

⊙ WORD SIZE

Data Path : 8-bit, 16-bit, 32-bit, 64-bit
Address Path : 32-bit

⊙ PC SYSTEM CHIPSET

694AX and 694AXL: VIA VT82C694X and VT82C686A chipset

694BX and 694BXL: VIA VT82C694X and VT82C686B chipset

⊙ FRONT SIDE BUS FREQUENCY

66 MHz 100MHz and 133MHz..

⊙ MEMORY

Three 168-pin DIMM sockets are designed onboard. Maximum memory size can be up to1.5GB with Parity/ECC.

⊙ BIOS

AWARD System BIOS. 2M bit Flash ROM

(Supports Plug & Play, ACPI, DMI and Green functions).

⊙ EXPANSION SLOTS

AGP Slot : One 32-bit AGP Slot (Supports 1x, 2x and 4X AGP graphics cards)

PCI Slot : Five 32bit PCI slots.

ISA Slot : One 16-bit ISA slot (the ISA slot is PCI/ISA shared)

AMR Slot : One AMR slot for audio and modem interface card.

⊙ WOL PORTS

One WOL connector supports Wake-On-LAN functionality.

◎ USB PORTS

Four Universal Serial Bus (USB) ports on the board.

◎ IDE PORTS

Two channels of Ultra DMA IDE ports designed on the board, which will support up to 4 IDE devices like IDE hard disk, ATAPI CD-ROM and LS-120/ZIP-100 devices.

694AX and 694AXL: Support Ultra DMA 33/66

694BX and 694BXL: Support Ultra DMA 33/66/100

◎ SUPER I/O PORTS

1. Two high speed NS16C550 compatible serial ports (UARTs).
2. One parallel port, supports SPP/EPP/ECP mode.
3. One Floppy Disk Control port.

◎ IR PORT

One HPSIR and ASKIR compatible IR transmission connector (5-pin).

◎ MOUSE AND KEYBOARD

One PS/2™ mouse connector, One PS/2™ keyboard connector.

◎ 3D SOUND (Optional)

Integrated PCI-mastering dual full-duplex direct-sound AC97-link-compatible sound interface. (694AXL and 694BXL do not have the audio interface onboard).

◎ HARDWARE MONITORING

The hardware monitoring feature is designed on the board to monitor hardware healthy status like system voltage, system temperature, and cooling fans. Such hardware monitoring will keep scanning the mainboard healthy status. If there is something does not work properly, it will give you the warning message so that you can take proper action to prevent your system from damage.

There is the hardware monitoring program in the CD which comes with this mainboard. When you feel like to use the hardware monitoring feature to monitor the mainboard healthy status, please refer to the following for the procedure:

1. Insert the CD disc into the CD ROM drive.
2. Change the directory to "D:\Driver\Mainboard\VIA\Hardware Monitoring"
3. Click on the "SETUP" icon and follow the screen instruction to complete the setup.

◎ ACPI

Advanced Configuration and Power Interface (ACPI) function is strongly recommended by PC'98 because it will let you have many additional features and that will make your PC system becomes very friendly and convenient. Followings are the ACPI features designed on the board:

1. On Now: power on the system by panel-switch, Modem ring-in, RTC alarm or LAN signal.
2. Power off (soft-off) by OS or Panel-switch.
3. Resuming of PC system. (such as Modem ring-in, RTC alarm, etc.)
4. Supports Full-On/Doze/Standby/Suspend operating modes.





◎ DIMENSION

1. Width & Length : 305 mm x 195 mm.
2. Height : 35 mm.
3. PCB Thickness : 4 layers.
4. Weight : around 1KG.

2. INSTALLATION

2.1 UNPACKING

The mainboard contains the following components. Please inspect the following contents and confirm that everything is there in the package. If anything is missing or damaged, call your supplier for instructions before proceeding.

-  Mainboard
-  User's manual
-  One IDE cable
-  One FDD cable
- USB Cable (optional choice)
-  One CD diskette for device driver and utility programs

The color box of the mainboard can protect the mainboard from unexpected damage during transportation. Since this mainboard contains electrostatic sensitive components and it can be easily damaged by static electricity. So the mainboard is sealed inside a ESD bag so that the mainboard can be protected against the unexpected damage. Please always leave the mainboard sealed in the original packing until when installing.

A grounded anti-static mat is recommended when unpacking and installation. Please also attached an anti static wristband to your wrist and have it grounded to the same point as the anti-static mat.

When you have opened the color box of the mainboard, observe the outlook of mainboard carefully to make sure there is no shipping and handling damage.

Having finished all the procedures above, you are now ready to install the mainboard to the chassis. Please make sure that the chassis is the ATX type so that the mounting hole will match with this mainboard.

2.2 QUICK INSTALLATION

This section provides a quick installation guide. If you do not have enough experience to install the mainboard the PC system correctly, please refer to the following procedures to install your PC system:

1. Refer to Section 2-1 to avoid the static electricity damage.
2. Remove the mainboard from the packing and put it on the table. (the surface must be very smooth)
3. Lift the actuation level of the CPU socket and then refer to the CPU user's guide to install the CPU onto the socket properly. (refer to Section 3-1 to find CPU socket)
4. When the CPU is installed on the socket, close the socket by lowering and locking the actuation lever.
5. Have the CPU cooling fan installed onto the CPU and connect it to the cooling fan power connector.
6. Install the DIMM module onto the DIMM socket. (refer to Section 3-2)
7. Install the mainboard into the cabinet. **(please do not connect the power cable!!)**.
8. Connect the panel switch and LED to the mainboard. (refer to Section 3-3)
9. Use the ribbon cable to connect the FDD, IDE HDD and CD ROM drive.
10. Install the VGA card, LAN card and FAX/Modem card ... etc.
11. Have the power supply connected to the ATX power connector on the mainboard.
12. Connect the peripheral devices such as monitor, keyboard, mouse ... etc.
13. Connect the power cable and power on the PC system.
14. When you see the POST screen display (refer to Section 4-1), click the "Del" key to trigger the BIOS setup screen.
15. Select "Load Optimized Defaults" in the BIOS setup program so that the suggested parameter will be loaded into the CMOS memory.
16. Exit the BIOS setup program and then restart the PC system.
17. Install the operation system (such as Windows).
18. Install the device drivers and other application software.

IMPORTANT NOTICE:

1. *Never power on the PC system unless a qualified cooling fan is installed properly.*
2. *Before all the components are installed in the PC system properly, please do not connect the power cable to the PC system.*
3. *Do not install mainboard into the cabinet and then install DIMM module and CPU. Otherwise, this mainboard may be damaged when install CPU and DIMM module.*

2.3 AMAZING WAYS TO POWER ON THE PC SYSTEM

When the mainboard has been installed successfully, there are several ways to power on the system. Please read the following description for all the details.

POWER BUTTON

The power button can be programmed by COMS setup program and it has different features. Please refer to page 3-12 for detail function description.

RTC ALARM

PC system can be started up by the RTC setting in the CMOS. You can set the alarming date and time in the RTC memory, When RTC alarms, the PC system will be triggered and waked up automatically on the date and time which you selected in the BIOS setup program.

Enable the "RTC Alarm Resume" selection in the BIOS setup utility, and then you will see the input request for the date and time. (the " RTC Alarm Resume" is located in the "POWER MANAGEMENT SETUP", please refer to Section 4.8), When you have stored the RTC alarm setting, the PC system will be turned on automatically according to the date and time which is recorded in the CMOS memory.

MODEM RING-IN

The PC system can be used as a fax machine to send or receive fax messages. But most people still use fax machine to receive their messages because it is not practical to have the system powered on all day long waiting for the incoming messages. Now the problem can be solved because this mainboard can be triggered by a modem ring-in signal.

When you have a *external modem* installed, you can leave the PC system power off. Whenever there is the incoming message, the PC system will be triggered by the ring-in signal and wake up automatically to receive the message for you. From now on, you can tell your PC system to receive the fax message for you.

In order to use the ring-in signal to wake up your PC system, you will have to use the *EXTERNAL MODEM* and have it connected to one of the *SERIAL PORTS*

(COM1 or COM2) on the mainboard. When the mainboard detects the ring-in signal from the serial port, the system power will be turned on and start to receive the incoming messages automatically. (you need to have the software like Award Zero-Volt Data-Suspend Utility so that you can use the fax utility to receive the incoming fax message).

To enable the Modem Ring-In feature, you have to run the BIOS setup utility and enable the "Modem / LAN Resume" option (it is located in the "POWER MANAGEMENT SETUP", please refer to Section 4.8 for the settings).

Note: This function is not available when using the internal MODEM card.

□ WAKE ON LAN (WOL)

There is a WOL connector CN16 on the mainboard which is designed to connect to the signal from a LAN card which supports the Wake On LAN feature. When such LAN card is installed, you may turn on the PC system from the remote server and monitor the PC status. To enable this feature, you will have to use the BIOS setup utility to enable the "Resume by Ring or LAN" in the BIOS setup program.

2.4 POWER OFF THE PC SYSTEM

There are two ways to power off the system. They are "Shut Down by Power Button" and " Shut Down by OS". (such as Windows® 95 and Windows® 98, you can choose the **Shut Down** from the file menu and the system will be powered off immediately).

IMPORTANT NOTICE:

"Shut down by O/S" is always recommended because "Shut Down by Power Button" under Windows operation may cause data lost of wrong configuration problem. Unless your system hangs and you can not use the "Shut down by O/S" to power off the PC system, please do not use the power button on the front panel to power off the PC system.

3. HARDWARE SETUP

Before you can start to install this mainboard, some hardware setting is required so that it will work perfectly. To configure the mainboard is a simple task, only a few jumpers, connectors, cables and sockets need to be selected and configured. This section will show all the connectors and jumpers on the mainboard.

3.1 INSTALLATION OF CPU

The connector on this mainboard where we can install the CPU is the socket 370 as shown in the following picture. The front side bus (FSB) speed of this mainboard will support from 66MHz, 100MHz and up to 133 MHz. So you may feel free to install the most updated socket type Pentium™ !!! or Celeron™ processor onto this mainboard.

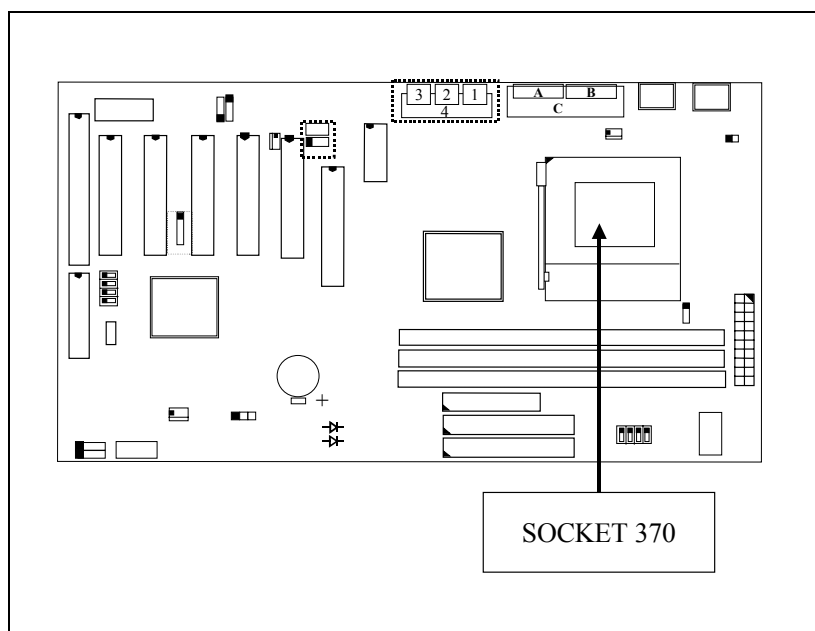

Be sure to remove the power cable from the PC system when installing CPU or any other components .

3.2 INSTALL THE DRAM MODULES

This mainboard has three DIMM sockets designed on the mainboard and you can use the single-side or double-side DIMM module on the mainboard.

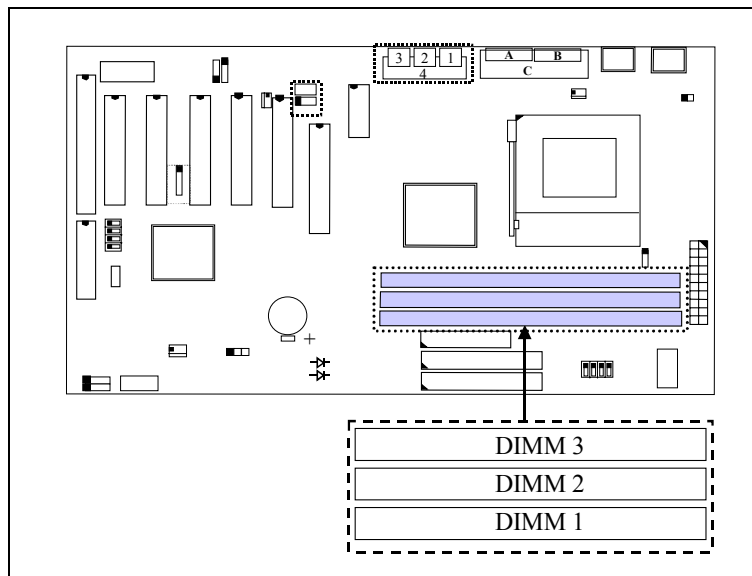

Picture of Memory sub-system.

In order to have a better performance and reliability to your PC system, please refer to the following suggestion to install the memory:

1. Outlook of DIMM modules:

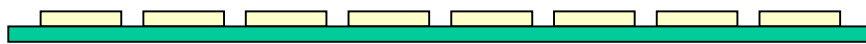

(Single-Side DIMM module)



(Double-Side DIMM Module)

2. **Minimum one DIMM module must be installed on the mainboard.**
3. **When the CPU FSB is 133MHz. please use 3.3V PC-133 DIMM module.**
4. **When the CPU FSB is 100MHz, please use 3.3V PC-100 or PC-133 DIMM module.**
5. **You can use single side or double side DIMM module on this mainboard.**

If your DIMM module does not have the parity bit, please don't enable the Parity/ECC check feature in the BIOS setup..

3.3 CONNECTORS

The connectors on the mainboard are either the pin header type or D-type connectors, they are used to connect the accessories or peripheral devices (such as power, mouse, printer,...etc.). Followings are the connectors with its description and the pin assignment which is designed on the mainboard.

(A) SLOT

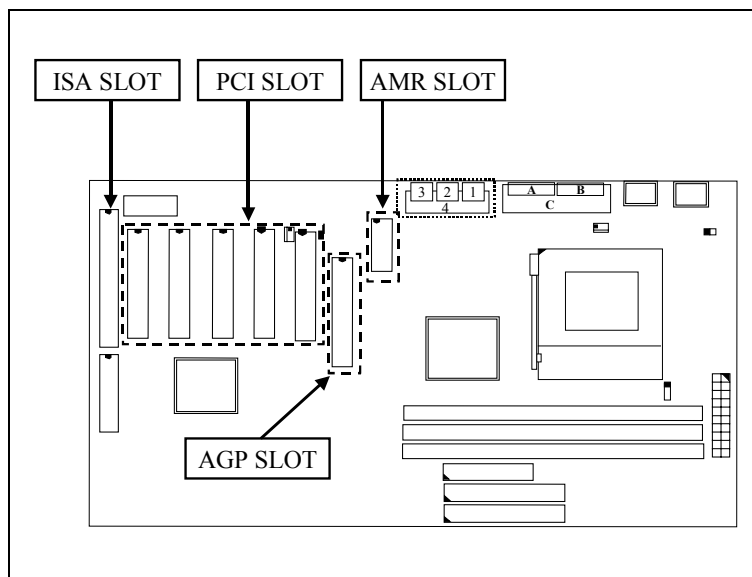

(B) CN1 / CN2: PS/2 Mouse and Keyboard Connector

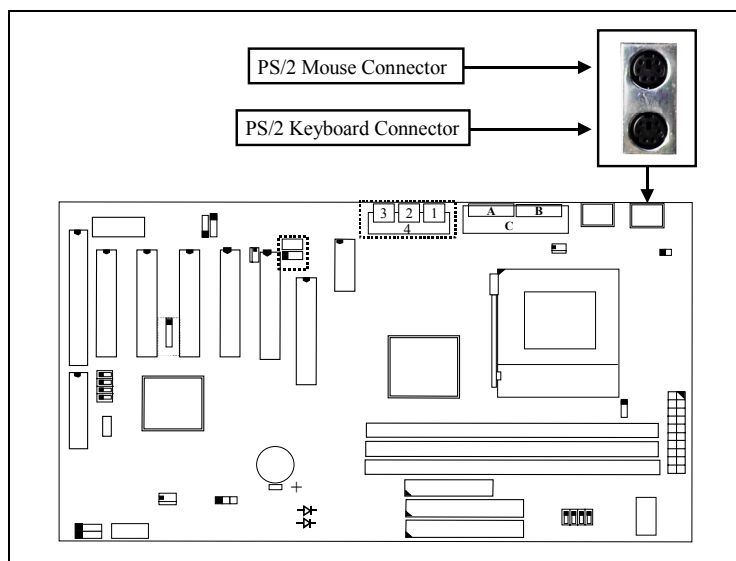

(C) CN3 : Serial Port COM 1 Connector

(D) CN4 : Serial Port COM 2 Connector

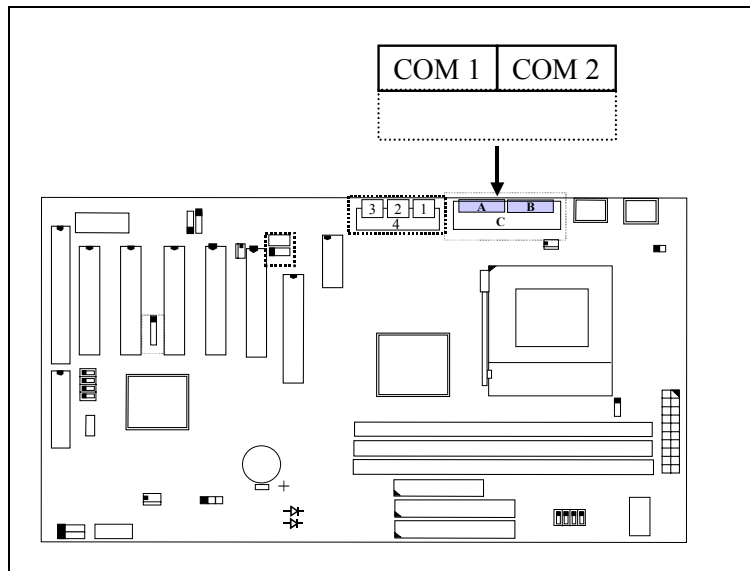

(I/O address: 3F8H/2F8H/3E8H/2E8H, IRQ3/IRQ4, selected by CMOS setup.)

(E) CN5: Parallel Port Connector

(Supports SPP/EPP/ECP modes, IRQ7 or IRQ5 is selectable, ECP mode will use either DMA channel 3 or channel 1 which can be selected by the CMOS setup program)

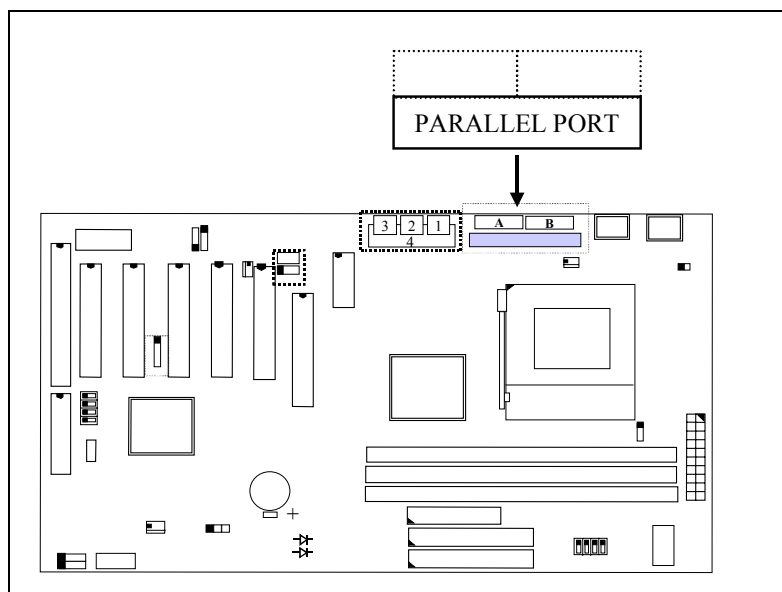

(F) CN6: USB Port 1 (Universal Serial Bus) Connector

(G) CN7: USB Port 2 (Universal Serial Bus) Connector

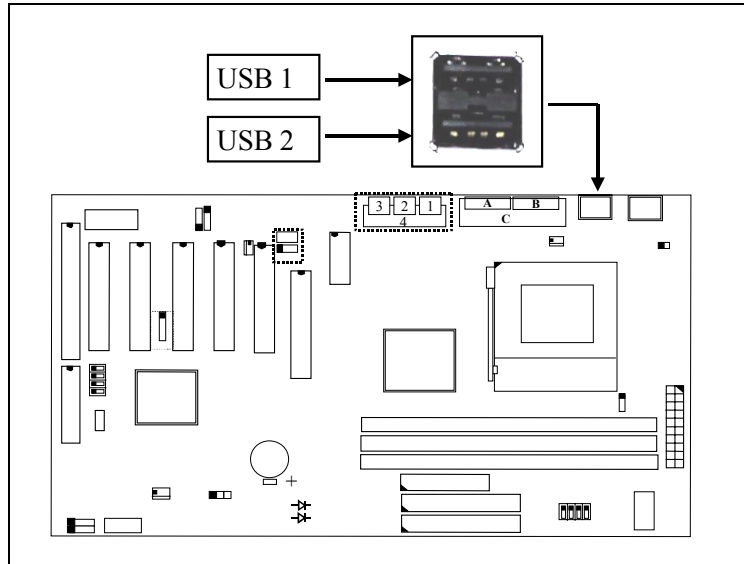

(H) CN8: Floppy Disk Control Port Connector (IRQ6, DMA channel 2)

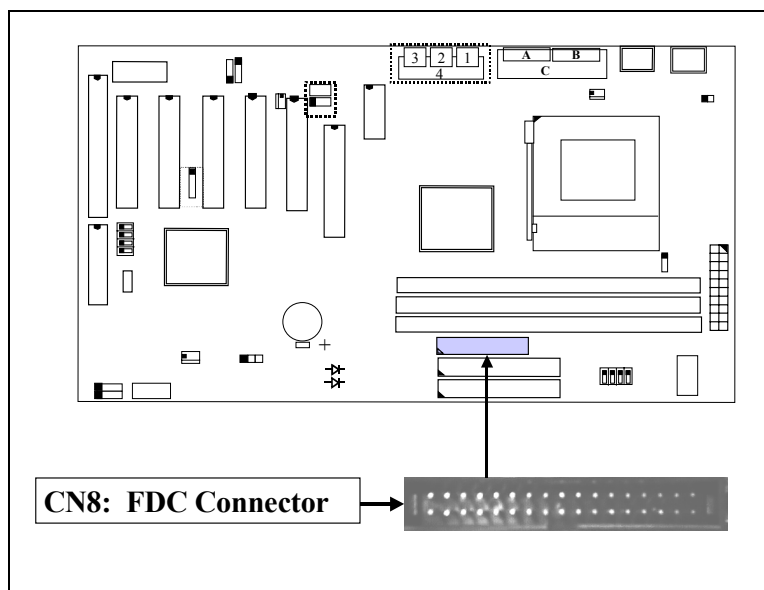

(I) CN9 : IDE 1 Connectors (Primary IDE Port: 1F0H, IRQ 14)

(J) CN10: IDE 2 Connectors (Secondary IDE Port: 170H, IRQ 15)

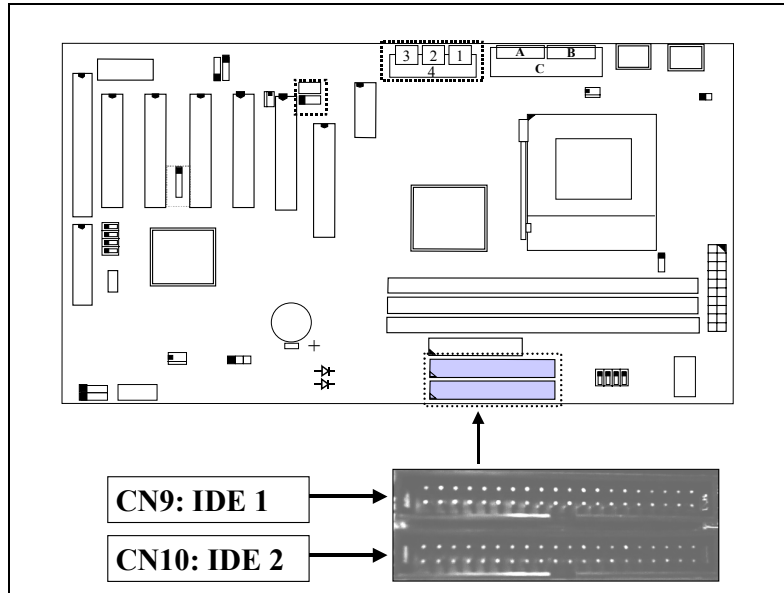

(K) CN12: IR (Infrared Rays) Connector

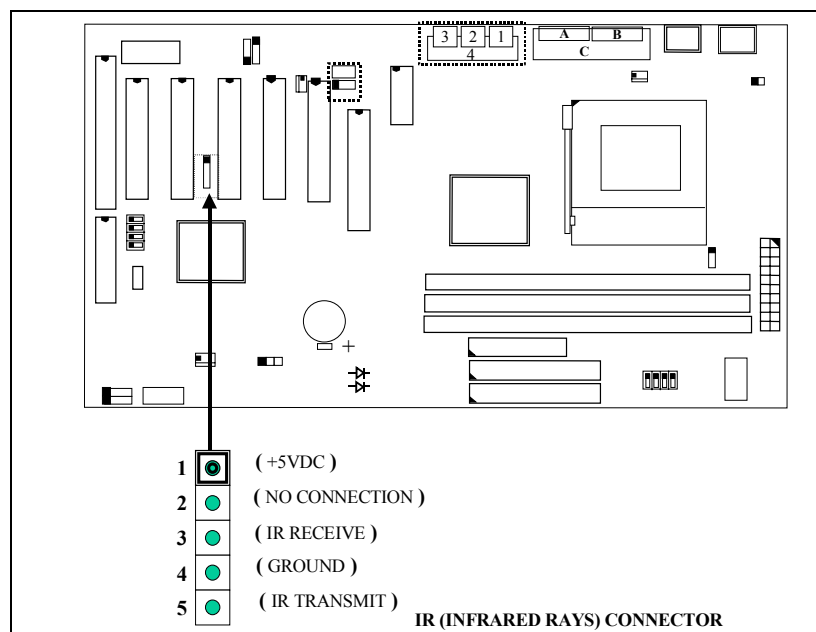

(L) CN13: CPU Cooling Fan Power Connector (Fan 1)

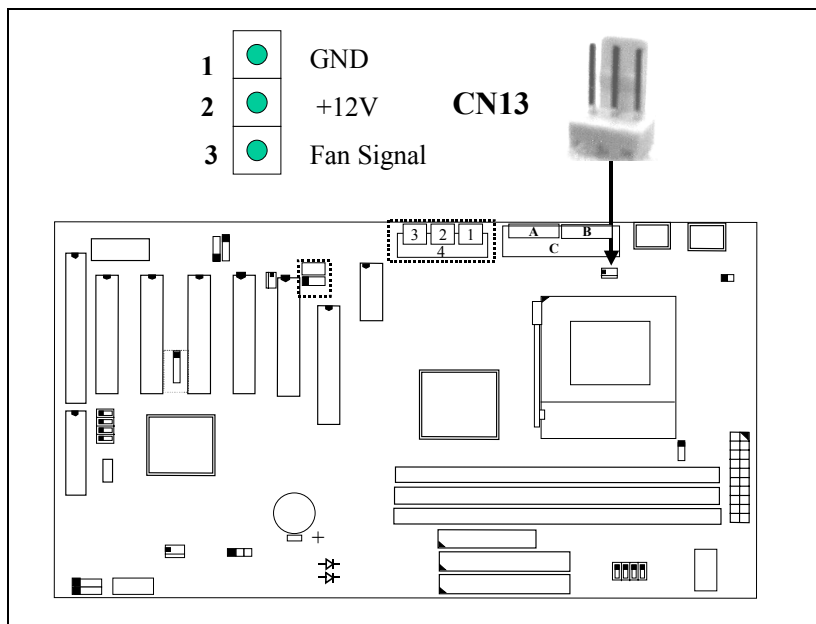

(M) CN15: ATX Power Connector

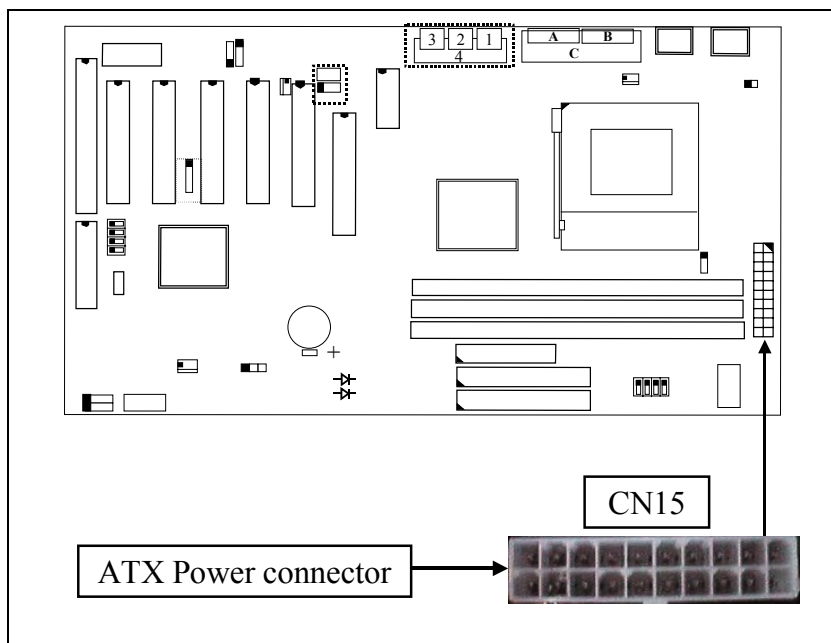

(N) CN16: WOL (Wake On LAN) Connector

In order to use the WOL LAN card to trigger the power of the PC system, the switching power supply must be able to provide at least 700mA current driving ability on the “5V standby” voltage.

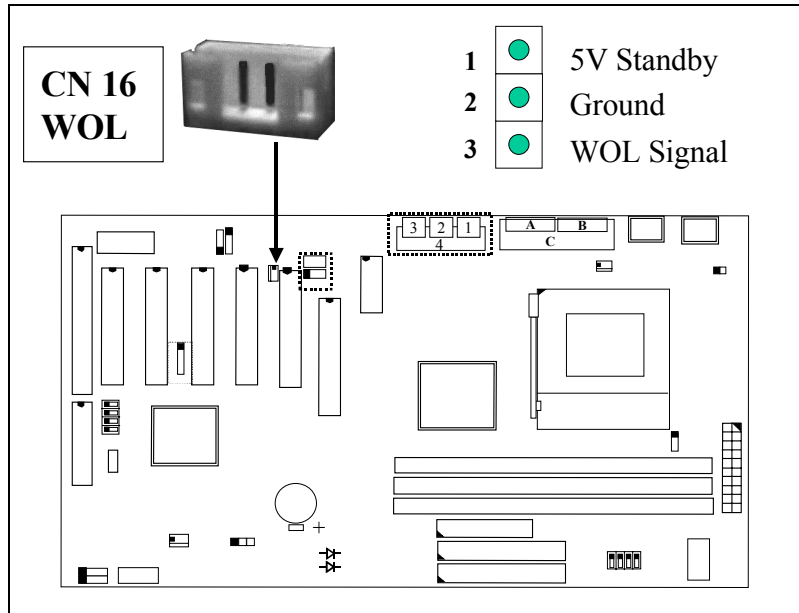

(O) CN17: Chassis Fan Power Connector (Fan 2)

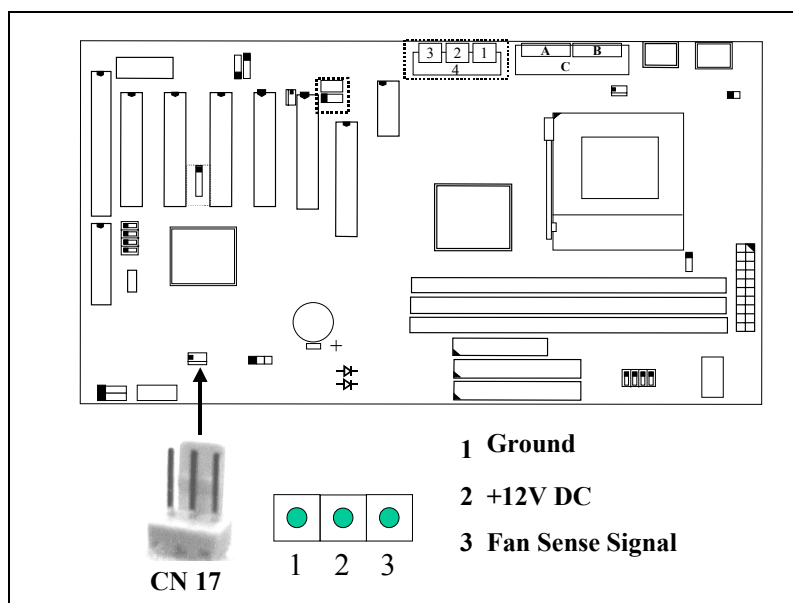

(P) CN18: Audio/Game Connector (optional choice)

The is the 3D audio interface is the optional choice for customers. If you find the CN18 installed, there is the 3D audio function included on the board.

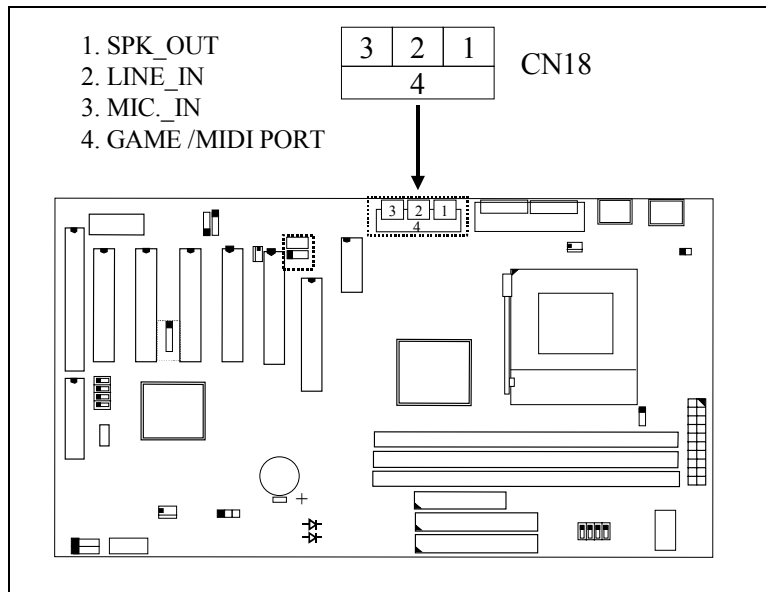

(Q) CN21 / CN22: CD-IN Connector (optional choice)

The CD-IN connectors on the board can be used to connect to the CD ROM audio out. There are two different type of connectors designed on the mainboard, please check with your CD ROM drive and decide which connector can be used to connect to the CD ROM drive.

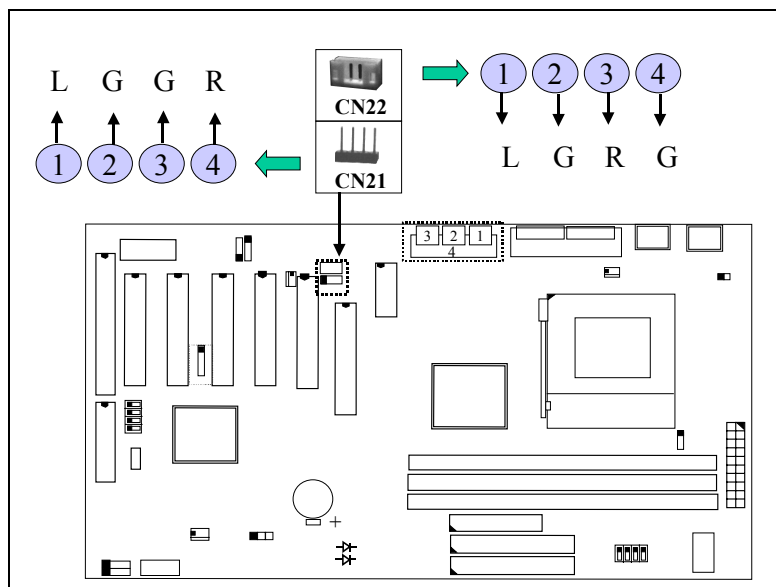

Note: L = Left channel audio-out
R = Right channel audio-out
G = Audio Ground

(R) CN30: USB Port 3 (Universal Serial Bus) Connector

(S) CN31: USB Port 4 (Universal Serial Bus) Connector

In order to connect the USB device, you will need to have the USB cable connected to the CN30 and CN31. Wrong USB cable may cause serious damage to this mainboard. Please contact your local supplier for the correct USB cable.

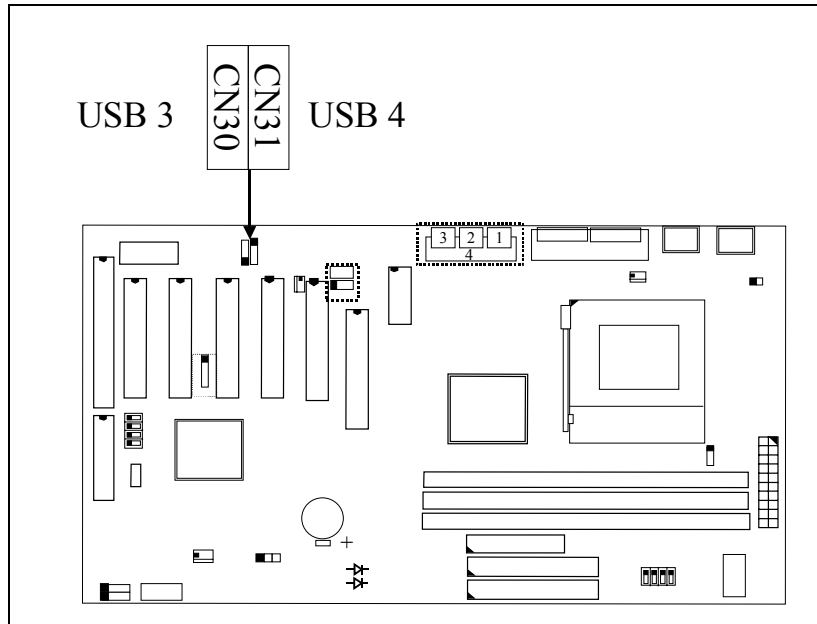

Pin assignment of USB connector:

CN 30 (USB3)

CN 31 (USB4)

<u>Pin #</u>	<u>Assignment</u>
● 5	Ground (BLACK WIRE)
● 4	Ground (BLACK WIRE)
● 3	DATA+ (GREEN WIRE)
● 3	DATA- (WHITE WIRE)
● 1	+5V DC (RED WIRE)

<u>Pin #</u>	<u>Assignment</u>
● 1	+5V DC (RED WIRE)
● 2	DATA- (WHITE WIRE)
● 3	DATA+ (GREEN WIRE)
● 4	Ground (BLACK WIRE)
● 5	Ground (BLACK WIRE)

IMPORTANT:

Wrong USB cable will destroy the mainboard, please make sure to use the correct USB cable on CN30 and CN31.

(T) Push buttons and LED connectors

A series of connectors are designed on the board to connect the push buttons and LED indicators. Followings are the details:

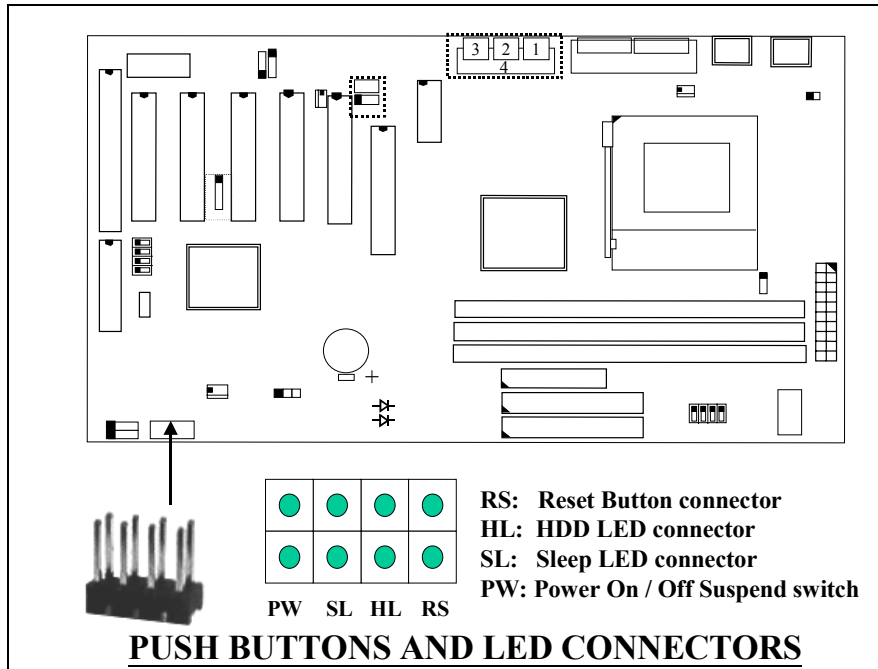
1. **RS** Reset Button Connector

<u>Pin #</u>	<u>Signal name</u>	<u>Pin1&2</u>	<u>Function</u>
1	Reset Control	Open	No action
2	Ground	Short	System Reset

2. **HL** IDE HDD LED Connector

<u>Pin #</u>	<u>Signal name</u>
1	+ 5V DC Pull-up
2	HDD Active Signal

3. **SL** Sleep LED Connector

This LED will be lightened when the AC power is connected and the system is power off, darkened when the AC power is disconnected or the system is powered on.

<u>Pin #</u>	<u>Signal name</u>
1	Signal Pin
2	Ground

4. **PW** Power On / Off and External Suspend Switch Connector
According to the setup in CMOS, the PW connector has two functions. It can be the Power Switch or Suspend Switch of your PC system.
(please refer to the Aware BIOS setup in Section 4)
- ① **If the setup in CMOS is “Delay 4 Sec.”, the function of “PW” will be:**
- A. When system power is "OFF":**
Press this switch, the system will power on.
- B. When system power is "ON" :**
- a. The system is in Full-ON mode :
- a-1. Click on this switch (less than 4 seconds), the system will be turned into Suspend mode. (turn into the GREEN mode)
- a-2. Press and hold this switch for more than 4 seconds, the system will be powered off.
- b. When the system is in Suspend mode :
- b-1. Click on this switch (less than 4 seconds), the system will return to Full-ON mode.
- b-2. Press and hold this switch more than 4 seconds, the system will be powered off.
- ② **The setup in CMOS is “Instant-off”:**
- A. When system power is "OFF" :**
Click on this switch, the system will be powered on.
- B. When system power is "ON" :**
Click on this switch, the system will be powered off instantly.

(U) Speaker and Power LED connector:

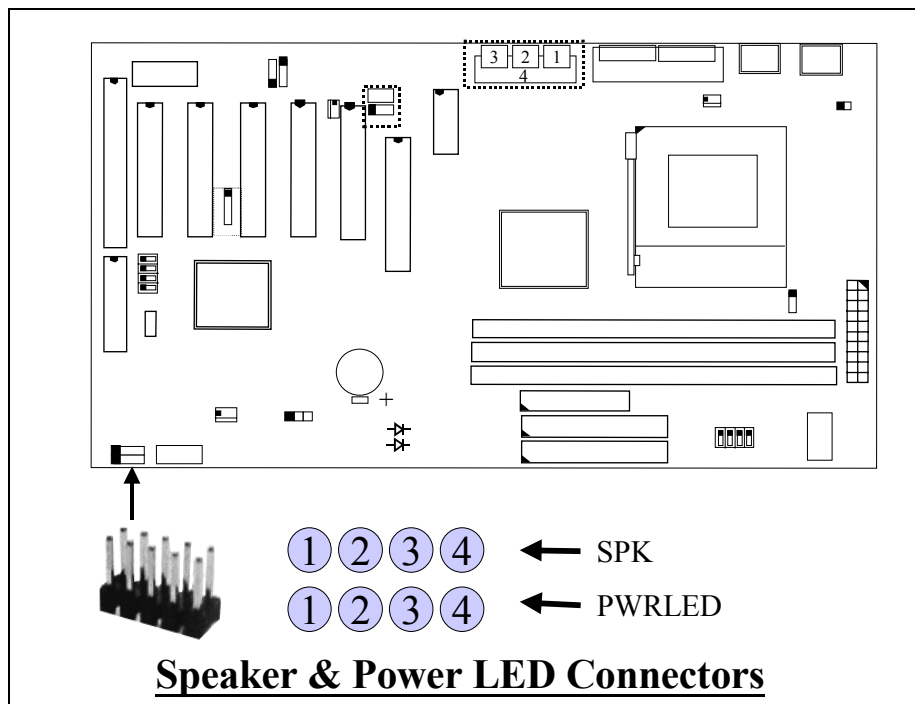

SPK: Speaker connector

<u>Pin #</u>	<u>Signal name</u>
1	+ 5V DC
2	No Connection
3	No Connection
4	Speaker Data Signal

PWRLED: Front Panel Power LED and Key-Lock Connector

<u>Pin #</u>	<u>Signal name</u>
1	Pullup (+ 5V DC for Power LED)
2	No Connection
3	Ground
4	No Connection

(V) Sleep LED Indicator:

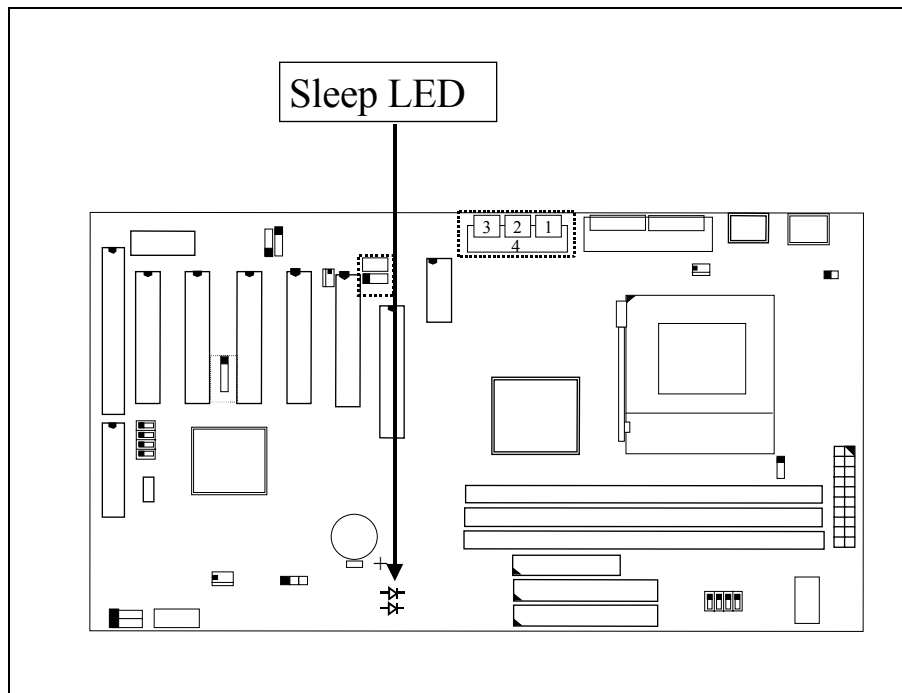

Sleep LED is designed to indicate the status of the PC system. When the PC system is powered on, the sleep LED will be darkened. When the power of the PC system is OFF, the sleep LED will be lightened to indicate the PC system is now under sleep mode.

Basically, when you see the sleep LED is lightened, it implies that the PC system is now in the sleep mode. However, since there is the standby voltage still active, so please do not install or remove any component from the mainboard. Whenever you want to install any component onto the mainboard, be sure to have the power cable disconnected to protect the PC system.

IMPORTANT !!!

Never install or remove any component on the mainboard when the system power is ON or the sleep LED is lightened.

3.4 JUMPERS

This section will discuss the jumper setting on the mainboard. In order to let you have better idea of the jumper setting, please see below for the explanation of jumper settings before you start this section.

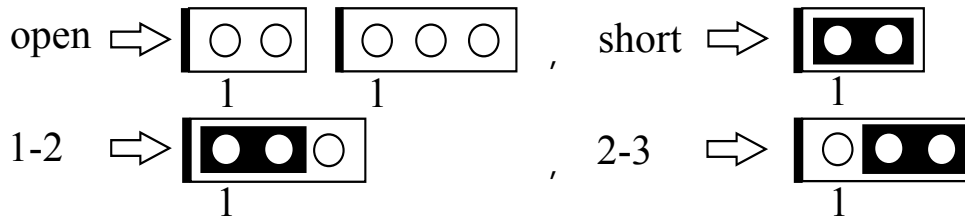

A jumper is a set of two, three or more jumper pins which allow users to make different system configuration by putting the plastic connector plug (mini-jumper) on it. The jumper setting is necessary when installing different components onto the mainboard.

(A) JP1: CPU Voltage Adjustment (Optional)

JP1 is designed for some special purpose. Sometimes you may feel that the CPU voltage detected by the mainboard can not meet your requirement and you want your CPU voltage a little bit higher than regular setting. In this case, you may use JP1 adjust the CPU voltage. When "SHORT" is selected, the CPU voltage will be 0.05V higher than normal voltage.

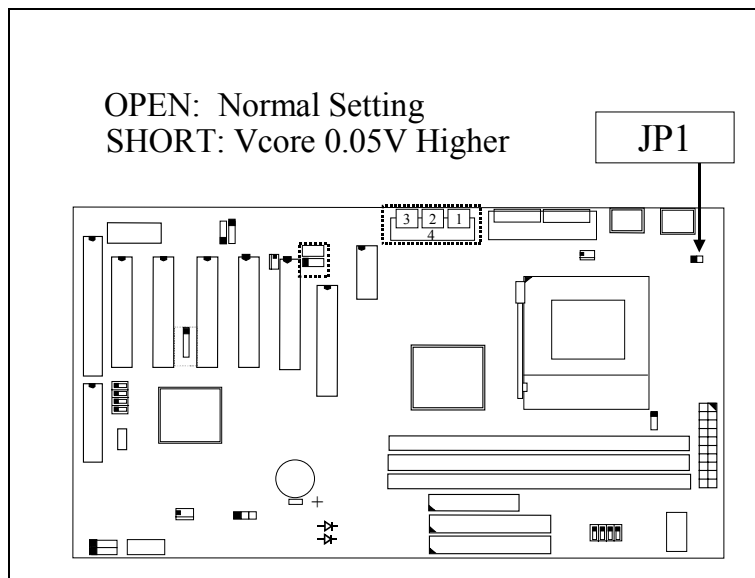

Note: When you use JP1 to raise the CPU voltage, it does not mean that CPU over clock is guaranteed!

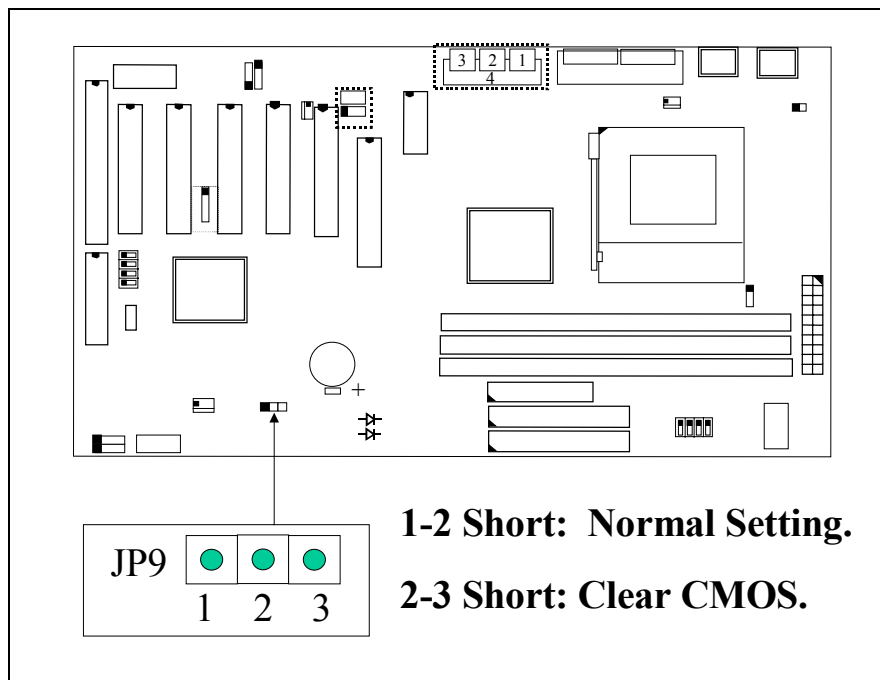
(B) JP9: CMOS Data Clear Button

Basically, the BIOS setup program will have all the setting saved in the CMOS memory which is included in the core logic of the mainboard. If you want to clear the setting which is saved in the CMOS memory, you may use JP9 and refer to the following procedure to clear the information in the CMOS.

Note: Improper BIOS setting may cause hang-up to the PC system, Should it be happened, you may use JP9 to clear the information which is stored in the CMOS memory and get the PC system back to normal. Improper connection may cause permanent damage to the mainboard. Please refer to the following steps to clear the CMOS

- 1. Unplug the AC power cable from the PC system.***
- 2. Put the mini jumper on pin 2-3 of JP9 around 3 to 5 seconds and then return it to the original position (pin 1-2).***
- 3. Re-connect the AC power cable.***

(C) SW1: CPU Front Side Bus (FSB) Speed Selection (optional choice)

SW1 is designed on the mainboard to select the CPU FSB speed. Please refer to the following for the settings:

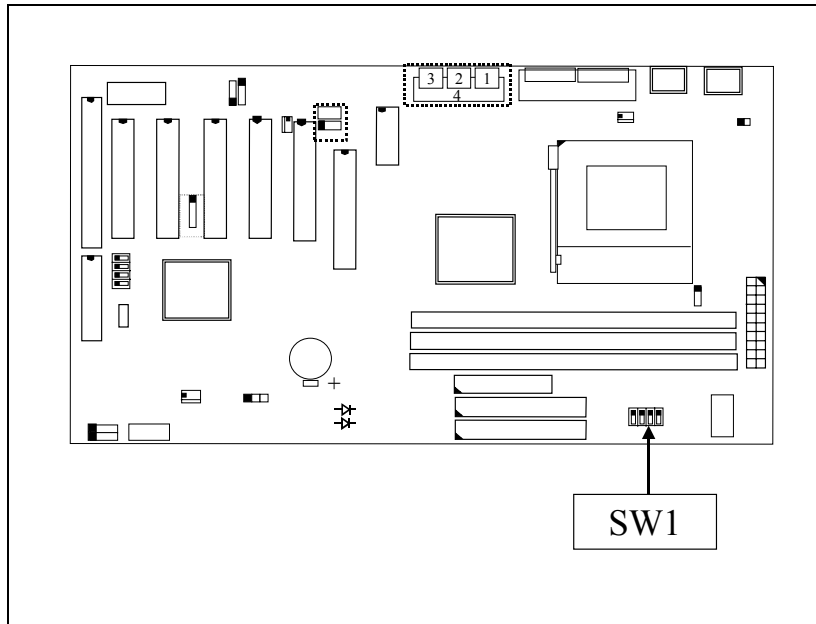

FSB Clock	SW 1-1	SW 1-2	SW 1-3	SW 1-4
AUTO	ON	OFF	ON	OFF
66MHZ	OFF	ON	OFF	ON
100MHZ	OFF	OFF	OFF	ON
133MHZ	OFF	OFF	OFF	OFF

Note. The "Auto" setting shown in the above table is strongly recommended because it will detect the CPU type and decide the proper FSB clock automatically. If you use the SW1 setting to select one of FSB clock from the above table, then no matter what kind of CPU is installed on the mainboard, the FSB clock will be all the same as what was chosen by the table above.

(D) SW2: CPU Clock Ratio Selection (optional choice)

SW2 is designed on the mainboard to select the CPU clock ratio. Basically, the CPU clock ratio will be decided by the CPU automatically. When you have installed the CPU onto the mainboard, the CPU clock ratio is decided automatically and you can not use the switch setting on SW2 to change the clock ratio. In case that your CPU allows you to change its the clock ratio, then you may use SW2 to select the clock ratio.

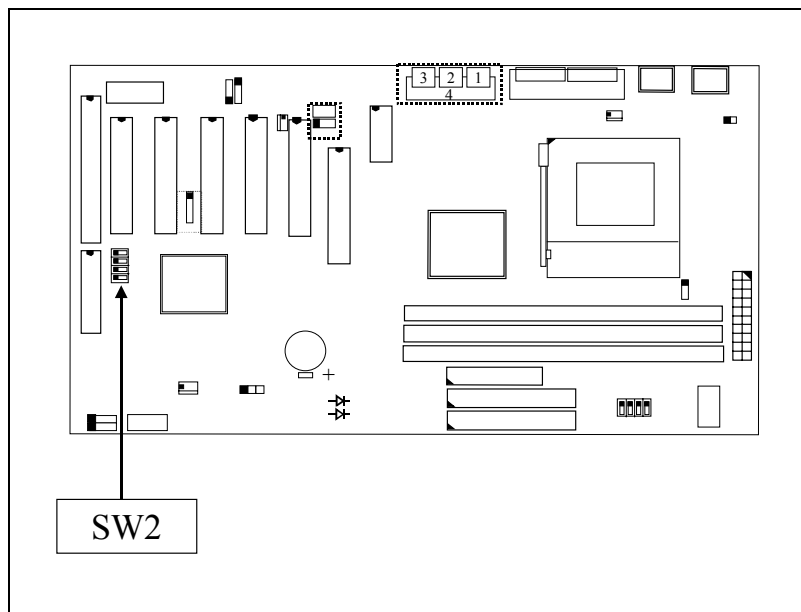

CPU Clock Ratio and its frequency				SW2			
Ratio	66MHz	100MHz	133MHz	SW2-1	SW2-2	SW2-3	SW2-4
3X	200	300	400	ON	OFF	ON	ON
3.5X	233	350	467	OFF	OFF	ON	ON
4X	266	400	533	ON	ON	OFF	ON
4.5X	300	450	600	OFF	ON	OFF	ON
5X	333	500	667	ON	OFF	OFF	ON
5.5X	366	550	733	OFF	OFF	OFF	ON
6X	400	600	800	ON	ON	ON	OFF
6.5X	433	650	866	OFF	ON	ON	OFF
7X	466	700	933	ON	OFF	ON	OFF
7.5X	500	750	1000	OFF	OFF	ON	OFF
8X	533	800		ON	ON	OFF	OFF

3.5 INSTALLATION OF DEVICE DRIVERS

IMPORTANT NOTE:

Please refer to the following sequence to install the related device drivers:

1. Install the device drivers for the mainboard.
2. Install the device driver for the onboard sound interface.
3. Install the device driver for the hardware monitoring.

A. Install the device drivers for this mainboard:

Before you can start to use this mainboard in your PC system, you will have to install some device driver so that it will work with operation system properly. Please refer to the following procedure to install the device drivers of the mainboard.

- Step1. Insert the CD into the CD ROM drive .
- Step2. Select "D:\Driver\Mainboard\VIA\Pentium_II" directory. (Note: "D:" is the device name of your CD ROM drive)
- Step3. Run "SETUP.EXE" in this directory and follow the screen display to install the mainboard device driver.

B. Install the device driver for the onboard sound interface:

There is the 3D sound interface designed on this mainboard. Please refer to the following procedure to install the device drivers:

- Step1. Insert the CD into the CD ROM drive when Windows requests for the sound card device driver. (Windows will detects the sound interface)
- Step2. Select "D:\Driver\Mainboard\VIA\Sound" directory.
- Step3. Run "SETUP.EXE" to install the device driver.

Note: You may need the Service Pack 4 (or the service pack which is newer) when installing the device driver for Microsoft Windows NT 4.0)

C. Install the device driver for the hardware monitoring:

This mainboard has the hardware monitoring feature designed on the board. Please refer to the following procedures to install the device driver of the hardware monitoring.

- Step 1. Insert the CD disc into the CD ROM drive.
- Step 2. Change the path to "D:\Driver\Mainboard\VIA\Hardware Monitoring"
- Step 3. Click on the "SETUP.EXE" icon and follow the screen instruction to complete the setup.

4. AWARD BIOS SETUP

4.1 GETTING STARTED

When you turn the system powered on or reset the PC system, the system BIOS will enter the POST routines (Power On Self Test routines). POST will execute a series of diagnostics and system initialization, and you will see the copyright message displayed on the screen.) In case that there is any error or malfunction detected, the BIOS will give a series of beeping sound or display the error message on screen.

During the power on self test (POST), the following message appears at the lower left corner of the screen:

" Press **DEL** to enter SETUP "

To execute the Award® BIOS CMOS Setup program, press the **DEL** key when you see the above message displayed on the screen to trigger the BIOS setup utility. When you start the BIOS setup program, you will see "STANDARD CMOS SETUP" displayed on the screen as shown in the next page:

4.2 CONTROL KEYS

When you have started the BIOS setup program, you will see a list of control key show at the bottom of the screen. You can use the keyboard to move the selection bar and choose the proper setting in each selection field. Please refer to the following for the definition of the control keys:

Arrow Keys : Use the arrow keys to move the cursor to the desired item.

Enter : Select the desired item.

F1 : Display the help screen for the selected feature.

ESC : Exit to the previous screen.

PgUp(-)/PgDn(+): Modify or change the content of the highlighted item.

F5 : Retrieves the previous value from CMOS data,
(only the current page setup will be retrieved).

F7 : Loads the SETUP default values from BIOS default table,
(only the current page setup will be loaded).

F10 : Save all changes to CMOS RAM from the MAIN MENU

4.3 MAIN MENU

ROM PCI / ISA BIOS (2A69KXXX)
 CMOS SETUP UTILITY
 AWARD SOFTWARE, INC.

Standard CMOS Setup	Frequency / Voltage Control
Advanced BIOS Features	Load Optimized Defaults
Advanced Chipset Features	Set Supervisor Password
Integrated Peripherals	Set User Password
Power Management Setup	Save & Exit Setup
PNP/PCI Configuration	Exit Without Saving
PC Health Status	
ESC : Quit	<input type="checkbox"/> <input type="checkbox"/> <input type="checkbox"/> <input type="checkbox"/> : Select Item
F10 : Save & Exit Setup	(Shift)F2 : Change Color
Time, Date, Hard Disk Type ...	

Fig. 4-1 CMOS SETUP MAIN MENU screen.

From the screen shown above, you will find many selection field in the BIOS setup program where you can make the setting of the mainboard configuration. In the following sections, we are going to give explanation of each selection field. Please refer to the following section and make proper configuration to your PC system.

4.4 STANDARD CMOS SETUP

CMOS Setup Utility - Copyright (C) 1984 - 2000 Award Software.

Date (mm : dd : yy) : Mon, Mar 10 2000	Item Help
Time (hh : mm : ss) : 16 : 03 : 33	Menu Level
IDE Primary Master Quantum Fireball CX13	Change this day, month, Year and century
IDE Primary Slave Pioneer DVD-ROM ATAPI	
IDE Secondary Master	
IDE Secondary Slave	
Drive A 1.44, 3.5 in.	
Drive B None	
Video EGA/VGA	
Halt On All, But Keyboard	
Base Memory 640K	
Extended Memory 130048K	
Total Memory 131072K	

This setup screen will provide you the related system information. You may setup the system date and time here. Please note that you will have to use this setup screen to select the hard disk type so that it will working normally in your PC system. Simply clock on the related selection field and then clock on the "Enter Key". And then select the correct hard disk type. (If you do not know how to make the selection, please consult with the technician for the support.)

4.5 ADVANCED BIOS FEATURES

CMOS Setup Utility - Copyright (C) 1984 - 2000 Award Software.

Advanced BIOS Features

		Item Help
Virus Warning	Disabled	
CPU Internal Cache	: Enabled	
External Cache	: Enabled	Menu Level 
CPU L2 Cache ECC Checking	: Enabled	
Processor Number Feature	: Disabled	
Quick Power On Self Test	: Enabled	Allows you to choose
First Boot Device	: Floppy	The Virus warning
Second Boot Device	: HDD-0	Feature for IDE Hard
Third Boot Device	: LS/ZIP	Disk boot sector
Boot Other Device	: Enabled	Protection. If this
Swap Floppy Drive	: Disabled	Function is enabled
Boot Up Floppy Seek	: Enabled	And some attempt to
Boot Up NumLock Status	: On	Write data into this
Gate A20 Option	: Normal	Area, BIOS will show a
Typematic Rate Setting	: Disabled	Warning message on
Typematic Rate (Chars/Sec)	: 6	Screen and alarm beep.
Typematic Delay (Msec)	: 250	
Security Option	: Setup	
PS/2 mouse function control	: Enable	
OS Select For DRAM > 64MB	: Non-OS2	
HDD S.M.A.R.T Capability	: Disabled	
Video BIOS Shadow	: Enabled	
C8000-CBFFF Shadow	: Disabled	
CC000-CFFFF Shadow	: Disabled	
D0000-D3FFF Shadow	: Disabled	
D4000-D7FFF Shadow	: Disabled	
D8000-DBFFF Shadow	: Disabled	
DC000-DFFFF Shadow	: Disabled	

Virus Warning :

This is the virus intruding warning feature in the BIOS. During and after the operation system is loaded, any attempt to write to the boot sector or partition table on the IDE hard disk drive will trigger this feature and give you some warning messages on the screen and then halt the system. When you find the message on your screen, please run the anti-virus program to see whether your system is infected by a virus or not.

Enabled : A warning message will be displayed on the screen when something attempts to access the boot sector or hard disk partition table.

Disabled : No warning message will appear on the screen when anything attempts to access the boot sector or hard disk partition table.

CPU Internal Cache / External Cache :

These fields allow you to turn on or turn off the Level 1 and Level 2 cache that built-in Pentium™ II/!!! or Celeron™ processors.

CPU L2 Cache ECC Checking:

This option will enable or disable the ECC checking on the CPU L2 cache. The ECC checking will ensure the accuracy of the data stored on the L2 cache.

Processor Number Feature:

You can not see this selection option unless you have the Pentium !!! processor installed on the mainboard. There is the serial code inside every Pentium !!! processor and it will be accessed by application to show your personal ID. If you don't feel like to give your serial code to other people, select the "Disabled" setting.

Quick Power on Self Test:

The Quick Power On Self Test will skip some test and speed up the boot process. If you find the system is working normally, you can always enable this feature so that you don't have to wait too long on the POST.

First / Second / Third Boot Device :

These fields allow you to decide the sequence of the boot devices.

Swap Floppy Drive :

When enable this option, the device name of the floppy drives will be swapped, For example, drive A will be treated as drive B, and drive B as Drive A.

Boot Up Floppy Seek

When enabled, the floppy drive will be initialized during POST.

Boot Up NumLock Status :

When enabled, the NumLock LED will be lightened after the POST.

Security Option :

This selection field allows you to select how to secure the PC system for you. There are two choice selectable - "Setup" and "System". Before you can apply the security option to your PC system, you have to select your own ""Supervisor Password" or "User Password" in the BIOS setup program.

When "Setup" is selected, you will have to input your "Passwords" before you can start the BIOS setup program. When you select "System", you will be unable to load the operation system if you don't key-in your personal "password"

PS/2 mouse function control :

This mainboard built-in a PS/2™ mouse port. In case that you prefer to connect a serial mouse to the serial port instead of using the PS/2™ mouse, you may choose "Disable" in this field so that the IRQ12 can be released for the other devices. If you are using the PS/2™ mouse, please leave this field "Enabled".

OS Select For DRAM > 64MB :

When you are using the "OS/2™" operating system and the system memory is more than 64MB, you will have to select the setting to "OS2", otherwise, leave this on the default setting "Non-OS2" for all other operating systems.

HDD S.M.A.R.T Capability :

There is the HDD which support the S.M.A.R.T. technology (Self Monitoring Analysis Reporting Technology). If your HDD support the SMART feature, you may enable this item and it will monitor and report the HDD healthy status to you.

Video BIOS / XXXX-XXXX Shadow

These fields allow you to enable / disable the shadow feature for the Video BIOS and the appropriate memory segment.

4.6 ADVANCED CHIPSET FEATURES

CMOS Setup Utility - Copyright (C) 1984 - 1999 Award Software

Advanced Chipset Features

	Disabled	Item Help
DRAM Timing By SPD	CPU Clock	
DRAM Clock	3	Menu Level 
SDRAM Cycle Length	Disabled	
Bank Interleave	Disabled	
Memory Hole	Enabled	
P2C/C2P Concurrency	Disabled	
System BIOS Cacheable	Disabled	
Video RAM Cacheable	64M	
AGP Aperture Size	Disabled	
AGP 4X Mode	Auto	
AGP Driving Control	DA	
AGP Driving Value	Disabled	
AGP Fast Write	Enabled	
On Chip USB	Disabled	
USB Keyboard Support	Auto	
OnChip Sound	Auto	
OnChip Modem	Enabled	
CPU to PCI Write Buffer	Enabled	
PCI Dynamic Bursting	Enabled	
PCI Master 0 WS Write	Enabled	
PCI Delay Transaction	Enabled	
PCI #2 Access #1 Retry	Enabled	
AGP Master 1 WS Write	Disabled	
AGP Master 1 WS Read	Disabled	
Memory Parity / ECC Check	Disabled	

This section allows you to configure the system based on the features of the VIA 82C694 chipset. This chipset manages bus speeds and access to system memory resources, such as DRAM and the external cache. It also coordinates communications between the conventional ISA bus and the PCI bus. The default settings have been chosen because they provide the best operating conditions for your system. So please do not change the default setting unless when necessary.

DRAM Timing By SPD

When enabled, the system BIOS will read the DRAM parameters from the SPD chip on the DIMM module and set the DRAM timing automatically.

DRAM Clock

This field allows you to select the DRAM access speed to control the memory performance.

DRAM Cycle Length

When synchronous DRAM is installed, the number of clock cycles of CAS latency depends on the DRAM timing. Do not reset this field from the default value specified unless you have the technical background.

BANK Interleave

This field allows you to select how many bank of DRAM is installed on the mainboard so that the system BIOS will be able to adjust the SDRAM interleave access mode to optimize the SDRAM performance.

Memory Hole

In order to improve performance, certain space in memory is reserved for ISA cards. This memory must be mapped into the memory space below 16MB. This field allows you to decide the memory mapping.

P2C/C2P Concurrency

This selection field allows you to enable/disable the PCI to CPU, CPU to PCI concurrency.

System BIOS Cacheable

Selecting *Enabled* allows caching of the system BIOS ROM at F0000h-FFFFFh, resulting in better system performance. However, if any program writes to this memory area, a system error may result.

Video RAM Cacheable

Select *Enabled* allows caching of the video RAM, resulting in better system performance. However, if any program writes to this memory area, a system error may result.

AGP Aperture Size

Select the size of Accelerated Graphics Port (AGP) aperture. The aperture is a portion of the PCI memory address range dedicated for graphics memory address space. Host cycles that hit the aperture range are forwarded to the AGP without any translation.

AGP- 4X Mode

This item allows you to enable / disable the AGP-4X Mode. Please make sure your AGP card supports the 4X AGP display mode before you can select *Enable*.

AGP Driving Control

This item allows you to adjust the AGP driving force. Choose *Manual* to key in a AGP Driving Value in the next selection. Basically, "Auto" is recommended to avoiding any error in your system.

AGP Driving Value

This item allows you to adjust the AGP driving force.

OnChip USB

This should be enabled if your system has a USB installed on the system board and you want to use it. Even when so equipped, if you add a higher performance controller, you will need to disable this feature.

USB Keyboard Support

Select *Enabled* if your system contains a Universal Serial Bus (USB) controller and you have a USB keyboard.

OnChip Sound

This item allows you to control the onboard AC 97 audio.

OnChip Modem

This item allows you to control the onboard MC 97 Modem.

CPU to PCI Write buffer

When this field is *Enabled*, writes from the CPU to the PCI bus are buffered, to compensate for the speed differences between the CPU and the PCI bus. When *Disabled*, the writes are not buffered and the CPU must wait until the write is complete before starting another write cycle.

PCI Dynamic Bursting

When *Enabled*, every write transaction goes to the write buffer. Burstable transactions then burst on the PCI bus and nonburstable transactions don't.

PCI Master 0 WS Write

When *Enabled*, writes to the PCI bus are executed with zero wait states.

PCI Delay Transaction

The chipset has an embedded 32-bit posted write buffer to support delay transactions cycles. Select *Enabled* to support compliance with PCI specification version 2.1.

PCI#2 Access #1 Retry

When disabled, PCI#2 will not be disconnected until access finishes (default). When enabled, PCI#2 will be disconnected if max retries are attempted without success.

AGP Master 1 WS Write

When *Enabled*, writes to the AGP(Accelerated Graphics Port) are executed with one wait states.

AGP Master 1 WS Read

When *Enabled*, read to the AGP (Accelerated Graphics Port) are executed with one wait states.

Memory Parity/ ECC Check

This item *enabled* to detect the memory parity and Error Checking & Correcting.

4.7 INTEGRATED PERIPHERALS

CMOS Setup Utility - Copyright (C) 1984 - 1999 Award Software

Integrated Peripherals

		Item Help
On-Chip IDE Chanel0	Enabled	
On-Chip IDE Chanel1	Enabled	
IDE Prefetch Mode	Enabled	Menu Level ➤
Primary Master PIO	Auto	
Primary Slave PIO	Auto	
Secondary Master PIO	Auto	
Secondary Slave PIO	Auto	
Primary Master UDMA	Auto	
Primary Slave UDMA	Auto	
Secondary Master UDMA	Auto	
Secondary Slave UDMA	Auto	
Init Display first	PCI Slot	
IDE HDD Block Mode	Enabled	
Onboard FDD Controller	Enabled	
Onboard Serial Port 1	Auto	
Onboard Serial Port 2	Auto	
UART 2 Mode	Standard	
IR Function Duplex	Half	
TX, RX inverting enable	No, Yes	
Onboard Parallel Port	378/IRQ7	
Onboard Parallel Mode	Normal	
ECP Mode Use DMA	3	
Parallel Port EPP Type	EPP 1.9	
Onboard Legacy Audio	Enabled	
Sound Blaster	Disabled	
SB I/O Base Address	220H	
SB IRQ Select	IRQ 5	
SB DMA Select	DMA 1	
MPU-401	Disabled	
MPU-401 I/O Address	330-333H	
Game Port (200-207H)	Enabled	

OnChip IDE Channel 0/1

The chipset contains a PCI IDE interface with support for two IDE channels. Select Enabled to activate the primary IDE interface. Select Disabled to deactivate this interface.

IDE Prefetch Mode

The onboard IDE drive interfaces supports IDE prefetching for faster drive accesses. If you install a primary and/or secondary add-in IDE interface, set this field to *Disabled* if the interface does not support prefetching.

Primary/Secondary, Master/Slave PIO

The four IDE PIO (Programmed Input/Output) fields let you set a PIO mode (0-4) for each of the four IDE devices that the onboard IDE interface supports. Modes 0 through 4 provide successively increased performance. In Auto mode, the system automatically determines the best mode for each device.

Primary/Secondary, Master/Slave UDMA

Ultra DMA/66 implementation is possible only if your IDE hard drive supports it and the operating environment includes a DMA driver (Windows 98 OSR2 or a third-party IDE bus master driver). If your hard drive and your system software both support Ultra DMA/66, select Auto to enable BIOS support.

Init Display First

This field allows you to decide to active whether PCI Slot of VGA card or AGP first.

IDE HDD Block Mode

Block mode is also called block transfer, multiple commands, or multiple sector read/write. If your IDE hard drive supports block mode (most new drives do), select Enabled for automatic detection of the optimal number of block read/writes per sector the drive can support.

Onboard FDD Controller

Select Enabled if your system has a floppy disk controller (FDC) installed on the system board and you want to use it. If you install add-in FDC or the system has no floppy drive, select Disabled in this field.

Onboard Serial Port 1/Port 2

These two selection fields allow you to select the I/O address and corresponding interrupt for the first and second serial ports.

UART 2 Mode

This item allows you to select which mode for the Onboard Serial Port 2.

IR Function Duplex

This item allows you to select the IR half/full duplex function.

TX,RX inverting enable

This item allow you to enable the TX, RX inverting which depends on different H/W requirement. This field is not recommended to change its default setting for avoiding any error in your system.

Onboard Parallel Port

This item allows you to determine onboard parallel port controller I/O address setting.

Onboard Parallel Port Mode

Select an operating mode for the onboard parallel (printer) port. Select *Normal*, *Compatible*, or *SPP* unless you are certain your hardware and software both support one of the other available modes.

ECP Mode Use DMA

This item allows you to select a DMA channel for the parallel port for use during ECP mode.

EPP Mode Select

This field allows you to select EPP port type between 1.7 or 1.9.

Onboard Legacy Audio

This field controls the onboard legacy audio.

- Sound Blaster
- SB I/O Base Address
- SB IRQ Select
- SB DMA Select
- MPU-401
- MPU-401 I/O Address
- Game Port (200-207H)

4.8 POWER MANAGEMENT SETUP

CMOS Setup Utility - Copyright (C) 1984 - 1999 Award Software
Power Management Setup

ACPI Function	Disabled	Item Help
Power Management	Press Enter	Menu Level ➤
PM Control By APM	Yes	
Video Off Option	Suspend -> off	
Video Off Method	Blank Screen	
Modem Use IRQ	3	
Soft-Off by PWRBTN	Instant – off.	
Wake-Up Events	Press Enter	

The Power Management Setup allows you to configure your system to most effectively save energy while operating in a manner consistent with your own style of computer use.

ACPI function

This item allows you to enable/disable the Advanced Configuration and Power Management (ACPI).

Power Management:

When click the "Enter" key on this selection field, the following setup screen will be triggered:

Power Management	User Define	Item Help
HDD Power Down	Disabled	Menu Level ➤
Doze Mode	Disabled	
Suspend Mode	Disabled	

Power Management

Disable	No power management. Disable all power saving modes.
Min. Power Saving	Minimum power management. Doze Mode = 1 hr. Standby Mode = 1 hr., Suspend Mode = 1 hr., and HDD Power Down = 15 min.
Max. Power Saving	Maximum power management -- ONLY AVAILABLE FOR SL CPU . Doze Mode = 1 min., Standby Mode = 1 min., Suspend Mode = 1 min., and HDD Power Down = 1 min.
User Defined	Allows you to set each mode individually. When not disabled, each of the ranges are from 1 min. to 1 hr. except for HDD Power Down which ranges from 1 min. to 15 min. and disable.

HDD Power Down

When enabled and after the set time of system inactivity, the hard disk drive will be powered down while all other devices remain active.

Doze Mode

When enabled and after the set time of system inactivity, the CPU clock will run at slower speed while all other devices still operate at full speed.

Suspend Mode

When enabled and after the set time of system inactivity, all devices except the CPU will be shut off.

PM Control by APM

When enabled, an Advanced Power Management device will be activated to enhance the Max. Power Saving mode and stop the CPU internal clock. If Advance Power Management (APM) is installed on your system, selecting Yes gives better power savings.

Video Off Option

When enabled, this feature allows the VGA adapter to operate in a power saving

mode.

Always On	Monitor will remain on during power saving modes.
Suspend --> Off	Monitor blanked when the systems enters the Suspend mode.
Susp,Stby --> Off	Monitor blanked when the system enters either Suspend or Standby modes.
All Modes --> Off	Monitor blanked when the system enters any power saving mode.

Video Off Method

This determines the manner in which the monitor is blanked.

V/H SYNC+Blank	This selection will cause the system to turn off the vertical and horizontal synchronization ports and write blanks to the video buffer.
Blank Screen	This option only writes blanks to the video buffer.
DPMS	Select this option if your monitor supports the Display Power Management Signaling (DPMS) standard of the Video Electronics Standards to select video power management values.

MODEM Use IRQ

This determines the IRQ in which the MODEM can use for power saving purpose. This mainboard has the ACPI feature designed on the board and it will “wakeup” automatically when it detects the incoming modem Ring-in signal. Before you can use the Ring-in signal to wakeup your PC system, you have to install the “External” modem to your PC system and tell the PC system which serial port connects to the modem by selecting the IRQ in this field. (officially, COM 1 uses IRQ4, and COM 2 uses IRQ3)

Soft-Off by PWRBTN

Pressing the power button for more than 4 seconds forces the system to enter the Soft-Off state when the system has “hung.”.

Suspend Type: (Default setting: "Stop Grant")

This field allows to select the suspend type, you can choose the CPU Stopy Grand Suspend or the PwrOn Suspend.

Wake Up Events:

When click the "Enter" key on this selection field, the following setup screen will be triggered:

VGA	OFF	Item Help
LPT & COM	LPT / COM	Menu Level ➤
HDD & FDD	ON	
PCI Master	OFF	
Modem / Lan Resume	Disabled	
Date (of Month)	0	
Resume Time (hh:mm:ss)	0 0 0	
Primary INTR	ON	
IRQs Activity Monitoring	Press Enter	

VGA

When *Enabled*, you can set the VGA awakens the system.

LPT & COM

When *On of* LPT & COM, any activity from one of the listed system peripheral devices or IRQs wakes up the system.

HDD & FDD

When *On of* HDD & FDD, any activity from one of the listed system peripheral devices wakes up the system.

PCI Master

When *On of* PCI Master, any activity from one of the listed system peripheral devices wakes up the system.

Modem / Lan Resume

An input signal on the serial Ring Indicator (RI) line (in other words, an incoming call on the modem) awakens the system from a soft off state.

Date (of Month)**Resume Time (hh:mm:ss)**

When RTC Alarm Resume is enabled, you can set the date and time at which the RTC (real-time clock) alarm awakens the system from Suspend mode.

IRQs Activity Monitoring

The following is a list of IRQ's, Interrupt ReQuests, which can be exempted much as the COM ports and LPT ports above can. When an I/O device wants to gain the attention of the operating system, it signals this by causing an IRQ to occur. When the operating system is ready to respond to the request, it interrupts itself and performs the service.

When set *On*, activity will neither prevent the system from going into a power management mode nor awaken it.

IRQ3 (COM 2)	Enabled	Item Help
IRQ4 (COM 1)	Enabled	Menu Level ➤
IRQ5 (LPT 2)	Enabled	
IRQ6 (Floppy Disk)	Enabled	
IRQ7 (LPT 1 Disk)	Enabled	
IRQ8 (RTC Alarm)	Disabled	
IRQ9 (IRQ2 Redir)	Disabled	
IRQ10 (Reserved)	Disabled	
IRQ11 (Reserved)	Disabled	
IRQ12 (PS/2 Mouse)	Enabled	
IRQ13 (Coprocessor)	Enabled	
IRQ14 (Hard Disk)	Enabled	
IRQ15 (Reserved)	Disabled	

4.9 PNP/PCI CONFIGURATION

CMOS Setup Utility - Copyright (C) 1984 - 1999 Award Software

PnP/PCI Configuration

PnP OS Installed	: No	Item Help
Reset Configuration Data	: Disabled	
Resources Controlled By	: Auto (ESCD)	Menu Level ➤
x IRQ Resources	: Press Enter	
x DMA Resources	: Press Enter	
PCI/VGA Palette Snoop	: Disabled	
Assign IRQ For VGA	: Enabled	
Assign IRQ for USB	: Enabled	
		Select yes if you are Using a plug and play Capable operating system. Select No if you need the BIOS to configure non-boot device.

PNP OS Installed

This item allows you to determine PnP OS is installed or not.

Reset Configuration Data

Normally, you leave this field Disabled. Select Enabled to reset Extended System Configuration Data (ESCD) when you exit Setup if you have installed a new add-on and the system reconfiguration has caused such a serious conflict that the operating system can not boot.

Resource controlled by

The Award Plug and Play BIOS has the capacity to automatically configure all of the boot and Plug and Play compatible devices. However, this capability means absolutely nothing unless you are using a Plug and Play operating system such as Windows®98.

IRQ Resources

When resources are controlled manually, assign each system interrupt a type, depending on the type of device using the interrupt

Legacy ISA Devices compliant with the original PC AT bus specification, requiring a specific interrupt (such as IRQ4 for serial port 1). PCI/ISA PnP Devices compliant with the Plug and Play standard, whether designed for PCI or ISA bus architecture.

DMA Resources

When resources are controlled manually, assign each system DMA channel as one of the following types, depending on the type of device using the interrupt.

Legacy ISA Devices compliant with the original PC AT bus specification, requiring a specific interrupt (such as IRQ4 for serial port 1). PCI/ISA PnP Devices compliant with the Plug and Play standard, whether designed for PCI or ISA bus architecture.

PCI/VGA Palette Snoop

Leave this field at *Disabled* all the time

Assign IRQ For VGA/USB:

Enable/Disable to assign IRQ for USB/VGA

4.10 PC HEALTH STATUS

CMOS Setup Utility - Copyright (C) 1984 - 1999 Award Software

PC Health Status

Current CPU Temp.	57°C/134°F	Item Help
Current System Temp.	25°C/77°F	
Current CPUFAN1 Speed	5904 RPM	Menu Level ▶
Current CPUFAN2 Speed	0 RPM	
Vcore	1.63V	
2.5V	2.58 V	
3.3V	3.55V	
5V	5.10V	
12V	12.24V	

The table above allows you to monitor the PC system healthy status. You can check on the related field and monitor the status like voltage, Temperature ... etc.

Current CPU Temp.

This field will show you the current CPU temperature

Current System Temp.

This field will show you the current temperature inside the PC system.

Current CPUFAN1 Speed

This field will show you the current CPU Cooling FAN1 speed.

Current CPUFAN2 Speed

This field will show you the current CPU Cooling FAN2 speed.

Vcore

This field and the files blow show you the current system voltage

4.11 FREQUENCY/VOLTAGE CONTROL

CMOS Setup Utility - Copyright (C) 1984 - 1999 Award Software

Frequency/Voltage Control

Auto Detect DIMM/PCI Clk	Disabled	Item Help
Spread Spectrum	Disabled	
CPU Host / PCI Clock	100 /33 MHz	Menu Level 
CPU Vcore Select	Default	

Auto Detect DIMM/PCI Clk

When “Enabled” is selected, the mainboard will detect the presence of devices on DIMM and PCI slots. When there is no device presented on some of the PCI or DIMM connector, the clock on the related DIMM and PCI slot will be disabled to reduce the Electro-Magnetic Interference (EMI).

Spread Spectrum

When Spread Spectrum is enabled, the EMI radiation on this mainboard will be reduced.

CPU Host / PCI Clock

This mainboard will detect the CPU type and decide the proper FSB and PCI clock automatically. If you want to select other clock frequency for the CPU, you can use this field to select the desired frequency. The selection is very simple. Simple use the “+” and “-“ key and you can select the frequency easily. Of course, you can also key-in the clock speed to this field directly.

CPU Vcore Select

This selection field allows you to fine tune the CPU core voltage. When you use this field to fine tune the CPU core voltage, you will see a selection table appeared as shown below:

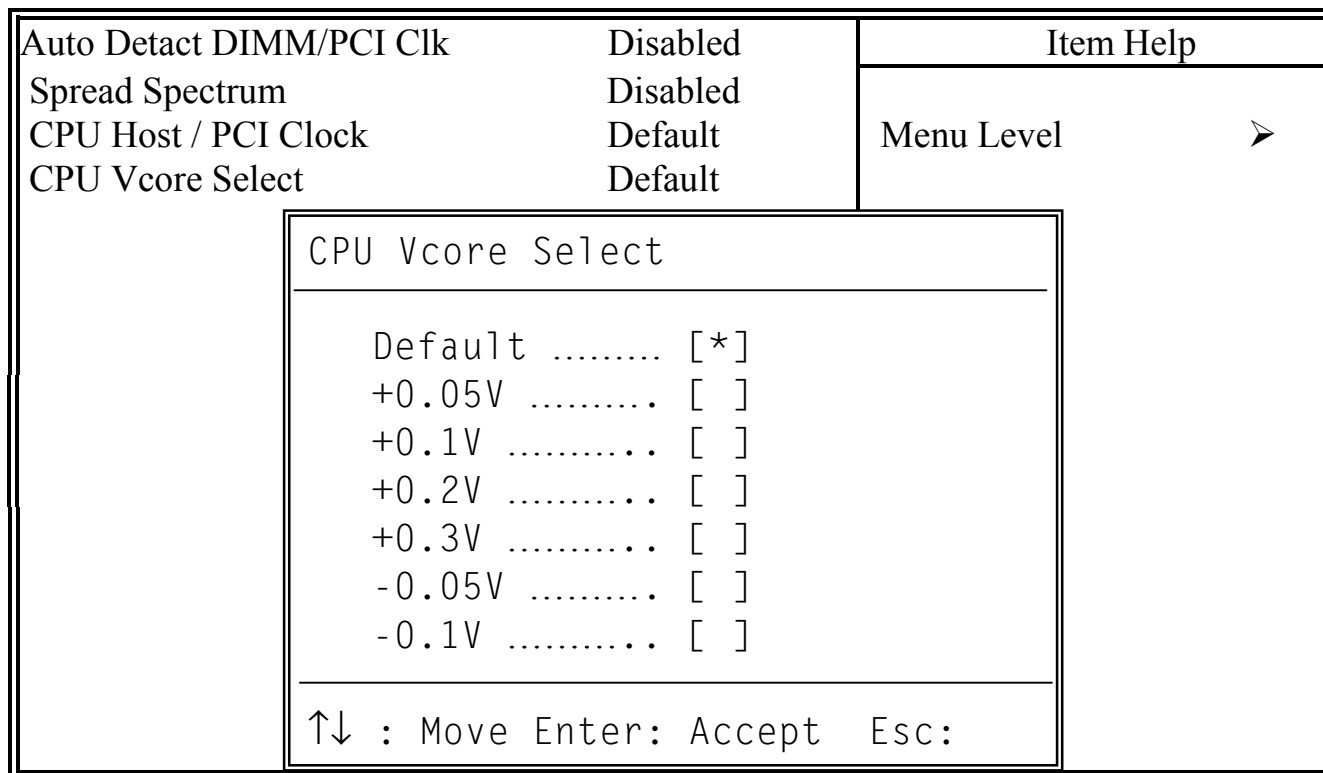

If you had used the “CPU Host / PCI Clock: to raise the CPU FSB clock speed, you may have to raise the CPU core voltage as well in order to make sure the CPU can work at the higher clock speed. Please refer to the following for the Vcore setting:

Default : Allow mainboard to detect the CPU type and decide Vcore automatically.

+0.05V: Raise the Vcore 0.05V higher than what is detected by the mainboard.

+0.1V: Raise the Vcore 0.1V higher than what is detected by the mainboard.

+0.2V: Raise the Vcore 0.2V higher than what is detected by the mainboard.

+0.3V: Raise the Vcore 0.3V higher than what is detected by the mainboard.

-0.05V: Reduce the Vcore 0.05V lower than what is detected by the mainboard.

-0.1V: Reduce the Vcore 0.1V lower than what is detected by the mainboard.

4.12 LOAD OPTIMIZED DEFAULTS

CMOS Setup Utility - Copyright (C) 1984 - 1999 Award Software

Standard CMOS Features	Frequency / Voltage Control
Advanced BIOS Features	Load Optimized Defaults
Advanced Chipset Features	Set Supervisor Password
Integrated Peripherals	Set User Password
Power Management Setup	Save & Exit Setup
PNP/PCI Configuration	Exit Without Saving
PC Health Status	
ESC : Quit	<input type="checkbox"/> <input type="checkbox"/> <input type="checkbox"/> <input type="checkbox"/> : Select Item
F10 : Save & Exit Setup	
Time, Date, Hard Disk Type ...	

There is the CMOS memory on the mainboard which can be used to store the system settings. In case that you don't know how to use the Award BIOS setup program to select the settings, you may use this field to load the optimized default which is defined in the system BIOS. Basically, the optimized default is chosen by the factory and it will give a series of parameters to make sure the best reliability and performance.

If you lost the CMOS data or you don't know how to complete the setup procedure, you may use this option to load the Optimized default values from the BIOS default table. The optimized default value is the suggested setting which will give the best reliability and also the good performance.

Incase that the CMOS data is corrupted, or if you made some CMOS setting and found that the PC system becomes very stable, then you may try to load the optimized default value and the CMOS will be changed to its default setting.

4.13 SET SUPERVISOR PASSWORD

CMOS Setup Utility - Copyright (C) 1984 - 1999 Award Software

Standard CMOS Features	Frequency / Voltage Control
Advanced BIOS Features	Load Optimized Defaults
Advanced Chipset Features	Set Supervisor Password
Integrated Peripherals	Set User Password
Power Management Setup	Save & Exit Setup
PNP/PCI Configuration	Exit Without Saving
PC Health Status	
ESC : Quit □□□□ : Select Item	
F10 : Save & Exit Setup	
Time, Date, Hard Disk Type ...	

The "SUPERVISOR PASSWORD" will be used to check the authority when power-on the PC system. The Supervisor Password will have different function according to the "Security Option" setup in Section 4.5:

When "Setup" is selected in Security Option:

If you want to change the BIOS setting, you will have to key-in the Supervisor Password so that you can start the BIOS setup program and change the system setting..

When "System" is selected in Security Option:

When turn on the PC system, it will request you to enter the Password. Without the correct password, the PC system will stop and the operation system will not be loaded.

4.14 SET USER PASSWORD

CMOS Setup Utility - Copyright (C) 1984 - 1999 Award Software

Standard CMOS Features	Frequency / Voltage Control
Advanced BIOS Features	Load Optimized Defaults
Advanced Chipset Features	Set Supervisor Password
Integrated Peripherals	Set User Password
Power Management Setup	Save & Exit Setup
PNP/PCI Configuration	Exit Without Saving
PC Health Status	
ESC : Quit □□□□ : Select Item	
F10 : Save & Exit Setup	
Time, Date, Hard Disk Type ...	

The User Password can be used to check the user's authority. However, this password entry is somewhat different to the "SUPERVISOR PASSWORD" mentioned in previous section. The User Password will have different function according to the "Supervisor Password" and the "Security Option" setup in Section 4.5:

A. When there is the password stored in the "SUPERVISOR PASSWORD"

1. When "Setup" is selected in Security Option:

When you use the "User Password" to log into the BIOS setup program, you can only select "User Password", "SAVE & EXIT SETUP" and "EXIT WITHOUT SAVING" from the main menu. (Use Supervisor Password to log into the PC system, you will have the complete right to on all BIOS settings.)

2. When "System" is selected in Security Option:

When you start the PC system, a message will appear on the screen request you to enter the Password. Without correct password, PC system will stop and the operation system won't be loaded.

B. When there is no password stored in the "SUPERVISOR PASSWORD"**1. When "Setup" is selected in Security Option:**

Users can use the "User Password" to log into the BIOS setup program, and they can make all the change in the BIOS setup program.

2. When "System" is selected in Security Option:

When turn on the PC system, it will request you to enter the Password. Without the correct password, the PC system will stop and the operation system will not be loaded.

4.15 SAVE & EXIT SETUP / EXIT WITHOUT SAVING

CMOS Setup Utility - Copyright (C) 1984 - 1999 Award Software

Standard CMOS Features	Frequency / Voltage Control
Advanced BIOS Features	Load Optimized Defaults
Advanced Chipset Features	Set Supervisor Password
Integrated Peripherals	Set User Password
Power Management Setup	Save & Exit Setup
PNP/PCI Configuration	Exit Without Saving
PC Health Status	
ESC : Quit □□□□ : Select Item	
F10 : Save & Exit Setup	
Time, Date, Hard Disk Type ...	

Save & Exit Setup:

This option will save all setup values to CMOS RAM & EXIT SETUP routine. Move the selection bar to "SAVE & EXIT SETUP" and pressing "Enter" key, then types "Y" and "Enter" key, the values will be saved and all the information will be stored in the CMOS memory.

Exit Without Saving

This item exit the setup routine without saving any changed values to CMOS RAM, When you do not want to save your change to the CMOS memory, you may choose to run this option and the setting what you made in the BIOS setup routine will be given away.

5. How to Update the System BIOS

Before we start to discuss system BIOS update, there are some important issues which you need to pay attention on it:

1. You can not exchange the system BIOS with another mainboard:
The system BIOS on different mainboard are different. If you take the system BIOS from another mainboard and have it installed on this mainboard, you may find that the mainboard fail to boot. Even the mainboard from the same manufacturer, the content of the system BIOS can be different. So please do not exchange the system BIOS.
2. Where to get the updated BIOS?
You can visit the web page of the supplier and down load the updated system BIOS. Please note that you will “kill” the PC system if you have the wrong BIOS written into the PC system. So please be sure to double check the system BIOS before you can use it to update the system BIOS.
3. No interruption is allowed during the BIOS updating:
When the BIOS updating, please do not restart the PC system or turn the power off. Otherwise, you will have a fragmentary system BIOS in your PC system and it will make you unable to start the PC system. If you reset or power off the PC system while the system BIOS is updating, you may have to send the PC system to the supplier for troubleshooting because you do not have the system BIOS in the PC system.
4. Do not change the onboard flash ROM:
The flash ROM is the storage device which is designed on the mainboard to store the system BIOS. There are different kinds of the flash ROM selling in the market. They have different capacity and different architecture. If you install improper flash ROM onto the mainboard, it may cause unexpected damage to the mainboard. So please never change the flash ROM on the mainboard, otherwise, the warranty will be void.

SYSTEM BIOS UPDATE PROCEDURE**Step 1. Download the system BIOS from the web page**

1. Visit the following web page:
<http://www.azza.com.tw>
2. Select "TECH SUPPORT"
3. Down load "AWDFLASH.EXE" program.
4. Scroll the screen downward and find the 694AX or 694BX mainboard.
5. Select the BIOS and start to down load. (the file name for 694AX and 694BX is 694XW.BIN. The file name for 694AXL and 694BXL is 694XLW.BIN)

Step 2. Prepare for the BIOS updating:

1. Windows is the multi task environment and some unexpected interruption can be occurred and stop the BIOS updating. Since no interruption is allowed during the BIOS updating. so the BIOS updating can not be made under the Windows environment.
2. Get a floppy diskette and put it into the floppy disk drive.
3. Key-in the following command under the DOS prompt:

C:> FORMAT A:/S

4. When the diskette formatting is completed, have the files which you down loaded from the web page copied into the floppy diskette. (BIOS file and AWDFLASH.EXE).

Step 3. Start to update the system BIOS:

1. Have the diskette which we made in Step 2 inserted in the floppy disk drive..
2. Start the PC system and click on the “del” key to start the BIOS setup program. Select the “Advanced BIOS features” and then make sure to select the floppy disk drive is the first boot device.
3. Having made the boot sequence selection, save the setup and restart the PC system.
4. When the DOS prompt “A:>” appears, run AWDFLASH.EXE program. (You can use “AWDFLASH /?” to more detail of the program.)
5. When you have started the “AWDFLASH.EXE”, it will ask you to input the file name of the new BIOS. Key-in “694XW.BIN or 694XLW.BIN” and then click the “ENTER” key.
6. When you see the message - Do you want to save BIOS (Y/N)?. you may choose “Y” to have the onboard BIOS copied in to the floppy diskette. If you do not want to make the backup copy of the onboard BIOS, simply chose “N” and start to update the system BIO. (if you want to make a backup copy of the onboard system BIOS, then select “Y” and then give a file name to the backup copy.)
7. You will see from the screen whether you are going to start the BIOS update. If you are sure that the new BIOS is correct and nothing is wrong, chose “Y” to start the BIOS update. (you can chose “N” and terminate the BIOS update program.)
8. During the BIOS updating, you will see the “Programming Flash Memory” message display on the screen. (**IMPORTANT: you can not stop or reset the PC system when the BIOS is updating.**)
9. When the BIOS update is completed, remove the floppy diskette from the floppy disk drive and restart the PC system..
10. When you see the PC system start to boot, it indicate that the BIOS update is successful.
11. Click the “del” key during the Power On Self Test to trigger the BIOS setup program..
12. Chose "Load Optimized Default" and have the default setting written into the CMOS memory.
13. Chose "Save and Exit" and then restart the PC system.
14. Having finished the procedures above, the BIOS update is completed.