

ASUS[®] P5A-VM
Super7 microATX Motherboard

USER'S MANUAL

USER'S NOTICE

No part of this manual, including the products and software described in it, may be reproduced, transmitted, transcribed, stored in a retrieval system, or translated into any language in any form or by any means, except documentation kept by the purchaser for backup purposes, without the express written permission of ASUSTeK COMPUTER INC. ("ASUS").

ASUS PROVIDES THIS MANUAL "AS IS" WITHOUT WARRANTY OF ANY KIND, EITHER EXPRESS OR IMPLIED, INCLUDING BUT NOT LIMITED TO THE IMPLIED WARRANTIES OR CONDITIONS OF MERCHANTABILITY OR FITNESS FOR A PARTICULAR PURPOSE. IN NO EVENT SHALL ASUS, ITS DIRECTORS, OFFICERS, EMPLOYEES OR AGENTS BE LIABLE FOR ANY INDIRECT, SPECIAL, INCIDENTAL, OR CONSEQUENTIAL DAMAGES (INCLUDING DAMAGES FOR LOSS OF PROFITS, LOSS OF BUSINESS, LOSS OF USE OR DATA, INTERRUPTION OF BUSINESS AND THE LIKE), EVEN IF ASUS HAS BEEN ADVISED OF THE POSSIBILITY OF SUCH DAMAGES ARISING FROM ANY DEFECT OR ERROR IN THIS MANUAL OR PRODUCT.

Product warranty or service will not be extended if: (1) the product is repaired, modified or altered, unless such repair, modification or alteration is authorized in writing by ASUS; or (2) the serial number of the product is defaced or missing.

Products and corporate names appearing in this manual may or may not be registered trademarks or copyrights of their respective companies, and are used only for identification or explanation and to the owners' benefit, without intent to infringe.

- ALi and Aladdin are trademarks of Acer Laboratories Inc. (ALi)
- Adobe and Acrobat are registered trademarks of Adobe Systems Incorporated.
- AMD, K6, Super7, and combinations thereof are trademarks of Advanced Micro Devices, Inc.
- Cyrix, M II, and combinations thereof are trademarks of National Semiconductor Corporation.
- ESS, Maestro, Solo-1 are registered trademarks of ESS Technology, Inc.
- IBM is a registered trademark of IBM Corporation.
- IDT and WinChip are trademarks of Integrated Device Technology, Inc.
- Intel, LANDesk, and Pentium are registered trademarks of Intel Corporation.
- Symbios is a registered trademark of Symbios Logic Corporation.
- Windows and MS-DOS are registered trademarks of Microsoft Corporation.

The product name and revision number are both printed on the product itself. Manual revisions are released for each product design represented by the digit before and after the period of the manual revision number. Manual updates are represented by the third digit in the manual revision number.

For previous or updated manuals, BIOS, drivers, or product release information, contact ASUS at <http://www.asus.com.tw> or through any of the means indicated on the following page.

SPECIFICATIONS AND INFORMATION CONTAINED IN THIS MANUAL ARE FURNISHED FOR INFORMATIONAL USE ONLY, AND ARE SUBJECT TO CHANGE AT ANY TIME WITHOUT NOTICE, AND SHOULD NOT BE CONSTRUED AS A COMMITMENT BY ASUS. ASUS ASSUMES NO RESPONSIBILITY OR LIABILITY FOR ANY ERRORS OR INACCURACIES THAT MAY APPEAR IN THIS MANUAL, INCLUDING THE PRODUCTS AND SOFTWARE DESCRIBED IN IT.

Copyright © 1999 ASUSTeK COMPUTER INC. All Rights Reserved.

Product Name:	ASUS P5A-VM
Manual Revision:	1.03 E383
Release Date:	May 1999

ASUS CONTACT INFORMATION

ASUSTeK COMPUTER INC. (Asia-Pacific)

Marketing

Address: 150 Li-Te Road, Peitou, Taipei, Taiwan 112
Telephone: +886-2-2894-3447
Fax: +886-2-2894-3449
Email: info@asus.com.tw

Technical Support

Tel (English): +886-2-2894-3447 ext. 706
Tel (Chinese): +886-2-2894-3447 ext. 111
Fax: +886-2-2895-9254
Email: tsd@asus.com.tw
Newsgroup: news2.asus.com.tw
WWW: www.asus.com.tw
FTP: ftp.asus.com.tw/pub/ASUS

ASUS COMPUTER INTERNATIONAL (America)

Marketing

Address: 6737 Mowry Avenue, Mowry Business Center, Building 2
Newark, CA 94560, USA
Fax: +1-510-608-4555
Email: info-usa@asus.com.tw

Technical Support

Fax: +1-510-608-4555
BBS: +1-510-739-3774
Email: tsd-usa@asus.com.tw
WWW: www.asus.com
FTP: ftp.asus.com.tw/pub/ASUS

ASUS COMPUTER GmbH (Europe)

Marketing

Address: Harkort Str. 25, 40880 Ratingen, BRD, Germany
Telephone: 49-2102-445011
Fax: 49-2102-442066
Email: sales@asuscom.de

Technical Support

Hotline: 49-2102-499712
BBS: 49-2102-448690
Email: tsd@asuscom.de
WWW: www.asuscom.de
FTP: ftp.asuscom.de/pub/ASUSCOM

CONTENTS

I. INTRODUCTION	7
How this Manual is Organized	7
Item Checklist	7
II. FEATURES	8
ASUS P5A-VM Motherboard	8
Introduction to ASUS Smart Series Motherboards	9
Parts of the ASUS P5A-VM Motherboard	11
III. INSTALLATION	12
ASUS P5A-VM Motherboard Layout	12
Installation Steps	14
1. Jumpers	14
Jumper Settings	14
Compatible Cyrix CPU Identification	18
2. System Memory (DIMM)	20
DIMM Memory Installation Procedures:	21
3. Central Processing Unit (CPU)	22
4. Expansion Cards	23
Expansion Card Installation Procedure:	23
Assigning IRQs for Expansion Cards	23
Assigning DMA Channels for ISA Cards	24
ISA Cards and Hardware Monitor	24
5. External Connectors	25
Power Connection Procedures	35
Support Software	36
Flash Memory Writer Utility	36
IV. BIOS SOFTWARE	36
Main Menu	36
Managing and Updating Your Motherboard's BIOS	38
6. BIOS Setup	39
Load Defaults	40

CONTENTS

Standard CMOS Setup	40
Details of Standard CMOS Setup	40
BIOS Features Setup	43
Details of BIOS Features Setup	43
Chipset Features Setup	45
Details of Chipset Features Setup	46
Power Management Setup	49
Details of Power Management Setup	49
PNP and PCI Setup	52
Details of PNP and PCI Setup	52
Load BIOS Defaults	54
Load Setup Defaults	54
Supervisor Password and User Password	55
IDE HDD Auto Detection	56
Save & Exit Setup	57
Exit Without Saving	57
V. SUPPORT SOFTWARE	58
ASUS Smart Motherboard Support CD	58
A. Video Driver	61
B. Other Video Drivers	65
C. ATI Player	75
D. Audio Driver	79
E. Audio Software	83
F. Software Wavetable	92
G. DMI Utility	93

FCC & DOC COMPLIANCE

Federal Communications Commission Statement

This device complies with FCC Rules Part 15. Operation is subject to the following two conditions:

- This device may not cause harmful interference, and
- This device must accept any interference received, including interference that may cause undesired operation.

This equipment has been tested and found to comply with the limits for a Class B digital device, pursuant to Part 15 of the FCC Rules. These limits are designed to provide reasonable protection against harmful interference in a residential installation. This equipment generates, uses and can radiate radio frequency energy and, if not installed and used in accordance with manufacturer's instructions, may cause harmful interference to radio communications. However, there is no guarantee that interference will not occur in a particular installation. If this equipment does cause harmful interference to radio or television reception, which can be determined by turning the equipment off and on, the user is encouraged to try to correct the interference by one or more of the following measures:

- Re-orient or relocate the receiving antenna.
- Increase the separation between the equipment and receiver.
- Connect the equipment to an outlet on a circuit different from that to which the receiver is connected.
- Consult the dealer or an experienced radio/TV technician for help.

WARNING! Any changes or modifications to this product not expressly approved by the manufacturer could void any assurances of safety or performance and could result in violation of Part 15 of the FCC Rules.

Canadian Department of Communications Statement

This digital apparatus does not exceed the Class B limits for radio noise emissions from digital apparatus set out in the Radio Interference Regulations of the Canadian Department of Communications.

This Class B digital apparatus complies with Canadian ICES-003.

Cet appareil numérique de la classe B est conforme à la norme NMB-003 du Canada.

I. INTRODUCTION

How this Manual is Organized

- | | |
|----------------------------|--|
| I. Introduction | Manual information and checklist |
| II. Features | Information and specifications concerning this product |
| III. Installation | Instructions on setting up the motherboard |
| IV. BIOS Software | Instructions on setting up the BIOS software |
| V. Support Software | Information on the included support software |

Item Checklist

Please check that your package is complete. If you discover damaged or missing items, contact your retailer.

- (1) ASUS Motherboard
- (1) IDE ribbon cable for master and slave drives
- (1) COM2 connector with bracket
- (1) Floppy ribbon cable for (1) 5.25inch and (2) 3.5inch floppy disks
- (1) Bag of spare jumpers
- (1) CD disc with support drivers and utilities
- (1) User's Manual
- Infrared external connector module (optional)

II. FEATURES

ASUS P5A-VM Motherboard

- **ALi AGPset:** ALi® (Acer Laboratories Inc.) Aladdin V AGPset with support for a 100MHz Front Side Bus (FSB), Accelerated Graphics Port (AGP), and all current Socket 7 processors.
- **Multi-Processor/Multi-Speed Support:** AMD K6™-III/400 & faster, AMD K6™-2/266 & faster, AMD K6™/166 & faster, AMD K5™/90–133, IBM®/Cyrix® 6x86MX™/M II™ (PR166 & faster), IDT WinChip 2™ /240 & faster, IBM®/Cyrix® 6x86-PR166+ (Rev 2.7 or later), Intel Pentium® 90–233MHz (P55C-MMX™, P54C/P54CS).
- **AGP 3D VGA:** Features optional ATI 3D Rage Pro AGP 2X (8MB SDRAM) or Rage IIC AGP (4MB SDRAM) for 3D hardware acceleration.
- **Enhanced ACPI and Anti-Boot Virus BIOS:** Features a programmable BIOS, offering enhanced ACPI for Windows 98 compatibility, built-in hardware-based virus protection through Trend ChipAwayVirus, and autodetection of most devices for virtually automatic setup.
- **PC100 Memory Support:** Equipped with three DIMM sockets to support Intel PC100-compliant SDRAMs (8, 16, 32, 64, 128, or 256MB) up to 768MB. These new SDRAMs are necessary to meet the enhanced 95MHz/100MHz bus speed requirement.
- **PCI Audio:** Features optional ESS 32-bit PCI audio onboard.
- **Ultra DMA/33 BM IDE:** Comes with an onboard PCI Bus Master IDE controller with two connectors that support four IDE devices in two channels, supports Ultra DMA/33, PIO Modes 3 and 4 and Bus Master IDE DMA Mode 2, and supports Enhanced IDE devices, such as Tape Backup, CD-ROM, and LS-120 drives.
- **Wake-On-LAN Connector:** Supports Wake-On-LAN activity with special network cards, such as the ASUS PCI-L101 10/100 Fast Ethernet PCI card.
- **PC Health Monitoring:** Provides (optional) a convenient utility to monitor your system's vital components/activities, such as fan rotations, voltages, and temperatures.
- **Super Multi-I/O:** Provides two high-speed UART compatible serial ports and one parallel port with EPP and ECP capabilities. UART2 can also be directed from COM2 (with Fast IR) to the Infrared Module for wireless connections.
- **Desktop Management Interface (DMI):** Supports DMI through BIOS, which allows hardware to communicate within a standard protocol creating a higher level of compatibility. (Requires DMI-enabled components.) (See section V)
- **Level 2 Cache SRAM/Tag RAM:** Features 512KB (up to 1MB when SRAM is available) pipelined-burst SRAM/L2 memory cache and integrated Tag RAM to make using the 100MHz bus speed possible.

II. FEATURES

Introduction to ASUS Smart Series Motherboards

Performance

- **SDRAM Optimized Performance:** ASUS Smart Series motherboards support the new generation memory—Synchronous Dynamic Random Access Memory (SDRAM)—which increases the data transfer rate from 264MB/sec maximum using EDO memory to 528MB/sec max using SDRAM.
- **Double the IDE Transfer Speed:** ASUS Smart Series motherboards with ALi's Aladdin V chipset improves IDE transfer rate using UltraDMA/33 Bus Master IDE, which can handle data transfer up to 33MB/sec. The best of all is that this new technology is compatible with existing ATA-2 IDE specifications so there is no need to upgrade current hard drives or cables.
- **Concurrent PCI:** Concurrent PCI allows multiple PCI transfers from PCI master buses to memory to CPU.
- **ACPI Ready:** ACPI (Advanced Configuration and Power Interface) is also implemented on all ASUS Smart Series motherboards. ACPI provides more Energy Saving Features for the future operating systems (OS) supporting OS Direct Power Management (OSPM) functionality. With these features implemented in the OS, PCs can be ready around the clock, yet satisfy all the energy saving standards. To fully utilize the benefits of ACPI, an OS that supports ACPI, such as Windows 98, must be used.
- **PC'98 Compliant:** Both the BIOS and hardware levels of the ASUS Smart Series motherboards meet PC'98 compliancy. The new PC'98 requirements for systems and components are based on the following high-level goals: Support for Plug and Play compatibility and power management for configuring and managing all system components, and 32-bit device drivers and installation procedures for Windows 95/Windows 98 and Windows NT.

Intelligence (with optional Hardware Monitor only)

- **Fan Status Monitoring and Alarm:** To prevent system overheat and system damage, the CPU fan and system fans are monitored for RPM and failure. Each fan can be set for its normal RPM range and alarm thresholds.
- **Temperature Monitoring and Alert:** To prevent system overheat and system damage, there is a heat sensor under the CPU and on the motherboard itself to monitor CPU and system temperature to make sure the system is operating at a safe heat level to avoid any failures triggered by extremely high temperature.

II. FEATURES

- **Voltage Monitoring and Alert:** System voltage levels are monitored to ensure stable current to critical motherboard components. Voltage specifications are more critical for future processors, so monitoring is necessary to ensure proper system configuration and management.
- **System Resources Alert:** Today's operating systems, such as Windows 95, Windows NT, and OS/2, require much more memory and hard drive space to present enormous user interfaces and run large applications. The system resource monitor will warn the user before the system resources are used up to prevent possible application crashes. Suggestions will give the user information on managing their limited resources more efficiently.
- **CPU Slow Down:** When CPU fans or system fans malfunction, the system will deactivate the CPU Clock line to decrease CPU utilization to the speed upon detection of system overheat. This will prevent CPU damage from system overheat. The CPU utilization will restore normal operations when temperature falls below a safe level.
- **Auto Fan Off:** The system fans will power off automatically **even in sleep mode**. This function reduces both energy consumption *and* **system noise**, and is an important feature in implementing silent PC systems.
- **Dual Function Power Button (requires ATX power supply):** The system can be in one of two states, one is Sleep mode and the other is Soft-Off mode. Pushing the power button for less than 4 seconds places the system into Sleep mode. When the power button is pressed for more than 4 seconds, it enters the Soft-Off mode.
- **Remote Ring On (requires ATX power supply):** This feature allows a computer to be turned on remotely through a modem. With this benefit on hand, any user can access vital information from their computer from anywhere in the world!
- **Message LED (requires ACPI-supported OS):** Chassis LEDs now act as information providers. Through the way a particular LED illuminates, the user can determine the stage the computer is in. A simple glimpse provides useful information to the user.

II. FEATURES

Parts of the ASUS P5A-VM Motherboard

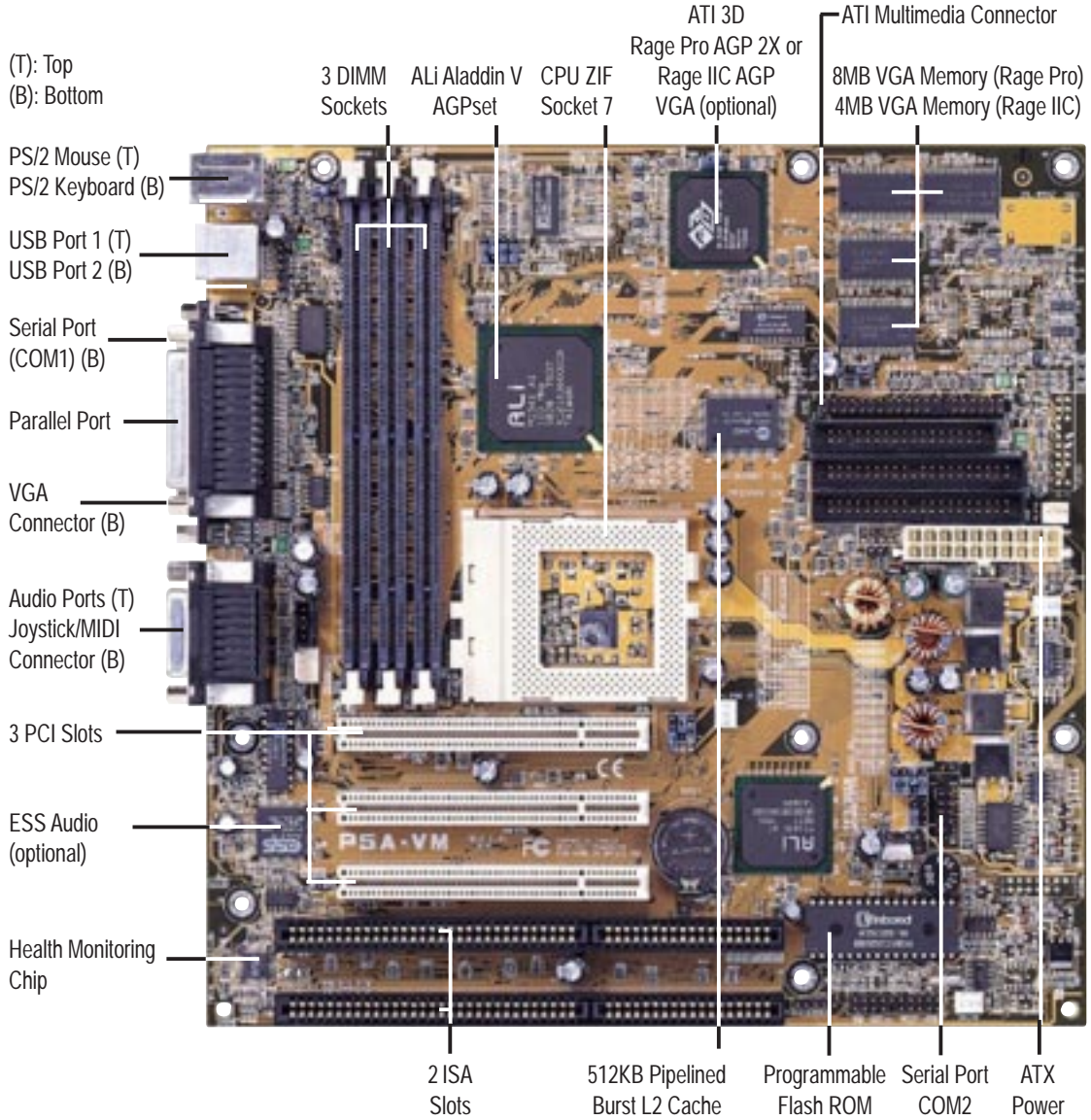

II. FEATURES
Motherboard Parts

III. INSTALLATION

ASUS P5A-VM Motherboard Layout

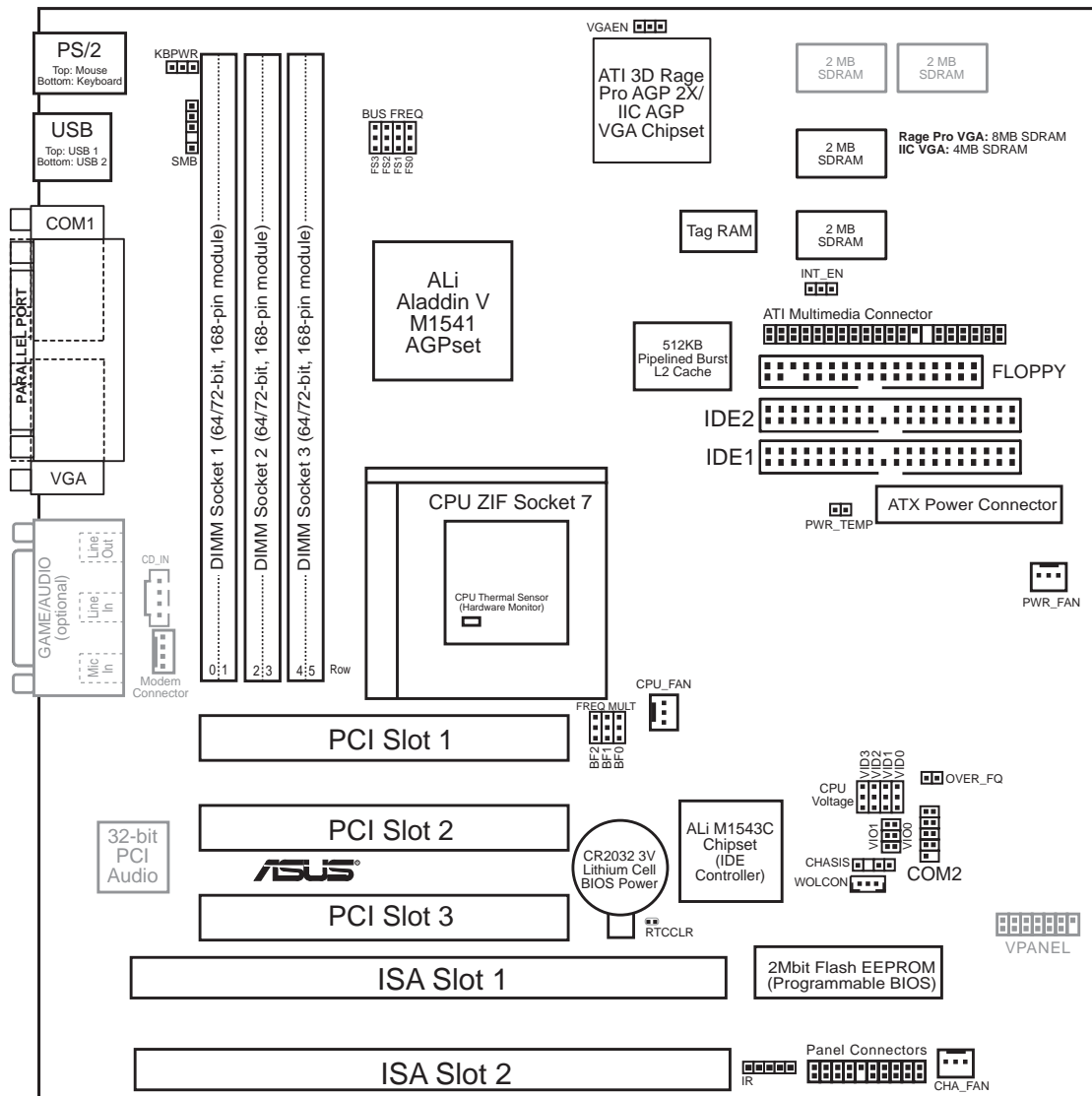

Dimmed components are optional.

III. INSTALLATION
Motherboard Layout

III. INSTALLATION

Jumpers

- | | | |
|---------------------------|-------|---|
| 1) INT_EN | p. 14 | VGA Interrupt Selection (Enable/Disable) |
| 2) VGAEN | p. 14 | VGA Setting (Enable/Disable) |
| 3) KBPWR | p. 15 | Keyboard Power (Wake) Up (Enable/Disable) |
| 4) VIO0/VIO1 | p. 15 | Voltage Input/Output Selection |
| 5) OVER_FQ | p. 15 | Overclock Frequency Setting |
| 6) FS0, FS1, FS2, FS3 | p. 16 | CPU External (BUS) Frequency Selection |
| 7) BF0, BF1, BF2 | p. 16 | CPU to BUS Frequency Multiple |
| 8) VID0, VID1, VID2, VID3 | p. 18 | Voltage Regulator Output Selection |
| 9) RTCCLR | p. 19 | Real Time Clock (RTC) RAM |

Expansion Slots

- | | | |
|----------------------|-------|---------------------------------------|
| 1) DIMM Sockets | p. 20 | 168-Pin DIMM Memory Expansion Sockets |
| 2) CPU ZIF Socket 7 | p. 22 | Central Processing Unit (CPU) Socket |
| 3) SLOT 1, SLOT2 | p. 23 | 16-bit ISA Bus Expansion Slots* |
| 4) PCI 1, PCI2, PCI3 | p. 23 | 32-bit PCI Bus Expansion Slots** |

Connectors

- | | | |
|------------------------|-------|---|
| 1) PS2KBMS | p. 25 | PS/2 Keyboard Connector (6-pin Female) |
| 2) PS2MBMS | p. 25 | PS/2 Mouse Connector (6-pin Female) |
| 3) PARALLEL | p. 26 | Parallel (Printer) Port Connector (26-1 pins) |
| 4) COM1, COM2 | p. 26 | Serial Port COM1 & COM2 (10-1 pins) |
| 5) VGA | p. 27 | Monitor (VGA) Outout Connector (15-Female) |
| 6) FLOPPY | p. 27 | Floppy Drive Connector (34-1 pins) |
| 7) GAME_AUDIO | p. 27 | Audio Port Connectors (Three 1/8" Female) |
| 8) GAME_AUDIO | p. 28 | Joystick/MidiConnector (15-pin Female) |
| 9) USB | p. 28 | Universal Serial BUS Ports 1 & 2 (Two 4-pin Female) |
| 10) PRIMARY/SECOND.IDE | p. 28 | Primary/Secondary IDE Connector (40-1 pins) |
| 11) CHASIS | p. 29 | Chassis Intrusion Alarm Lead (4-1 pins) |
| 12) ATX | p. 30 | ATX Motherboard Power Connector (20 pins) |
| 13) IR | p. 30 | IrDA/Fast IR-compliant Infrared Module Connector (5 pins) |
| 14) PWR (PANEL) | p. 31 | ATX Power Switch/Soft Power Switch Lead (2 pins) |
| 15) IDELED (PANEL) | p. 31 | IDE Activity LED Lead (2 pins) |
| 16) PLED (PANEL) | p. 31 | System Power LED Lead (2 pins) |
| 17) RESET (PANEL) | p. 31 | Reset Switch Lead (2 pins) |
| 18) MLED (PANEL) | p. 31 | System Message LED (2 pins) |
| 19) KEYLOCK (PANEL) | p. 31 | Keyboard Lock Switch Lead (2 pins) |
| 20) SPEAKER (PANEL) | p. 31 | Speaker Output Connector (4 pins) |
| 21) WOLCON | p. 32 | Wake-on-LAN Activity Connector (3 pins) |
| 22) CD_IN | p. 32 | Stereo Audio In Connector (4 pins) |
| 23) MODEM | p. 32 | MODEM Card Voice In Connector (4 pins) |
| 24) SMB | p. 33 | SMBus Connector (5-1 pins) |
| 25) PWR_TEMP | p. 33 | Power Supply Temperature External Connector (2 pins) |
| 26) FAN | p. 34 | Power Supply, Chassis, CPU Fan Power Leads (Three 3 pins) |

*The onboard hardware monitor uses the address 290H-297H so legacy ISA cards must not use this address or else conflicts will occur.

III. INSTALLATION

Installation Steps

Before using your computer, you must complete the following steps:

1. **Set Jumpers on the Motherboard**
2. **Install System Memory Modules**
3. **Install the Central Processing Unit (CPU)**
4. **Install Expansion Cards**
5. **Connect Ribbon Cables, Cabinet Wires, and Power Supply**
6. **Setup the BIOS Software**

1. Jumpers

WARNING! Computer motherboards, baseboards and components, such as SCSI cards, contain very delicate Integrated Circuit (IC) chips. To protect them against damage from static electricity, you should follow some precautions whenever you work on your computer.

1. Unplug your computer when working on the inside.
2. Use a grounded wrist strap before handling computer components. If you do not have one, touch both of your hands to a safely grounded object or to a metal object, such as the power supply case.
3. Hold components by the edges and try not to touch the IC chips, leads or connectors, or other components.
4. Place components on a grounded antistatic pad or on the bag that came with the component whenever the components are separated from the system.

Jumper Settings

1. **VGA Interrupt Selection (INT_EN) / 2. **VGA Setting (VGAEN)****

INT_EN allows you to set the VGA interrupt method. The default disables the chipset's internal interrupt routing. Some TV tuners or MPEG cards may require the interrupt be assigned by the onboard chipset, in which case INT_EN must be enabled. VGAEN allows you to enable or disable the onboard VGA. Disable the onboard VGA if you are using a VGA card on the expansion slot.

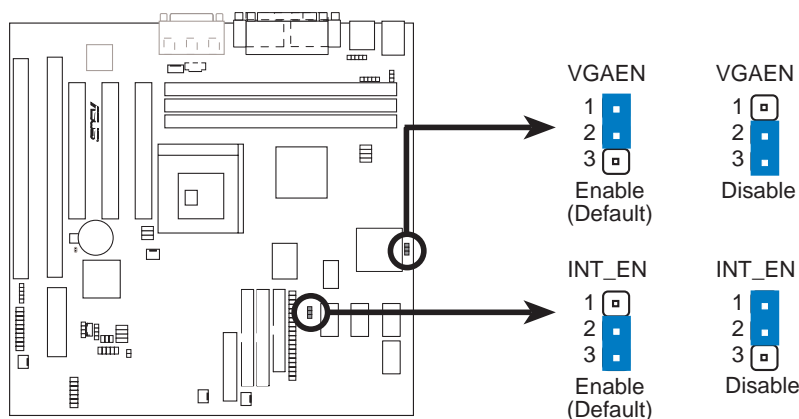

P5A-VM VGA Settings

III. INSTALLATION

3. Keyboard Power (Wake) Up (KBPWR)

This allows you to disable or enable the keyboard power or wake up function. Set to *Enable* if you want to use your keyboard (by pressing <Spacebar>) to power or wake up your computer. The default is set to *Disable* because not all computers have the appropriate ATX power supply.

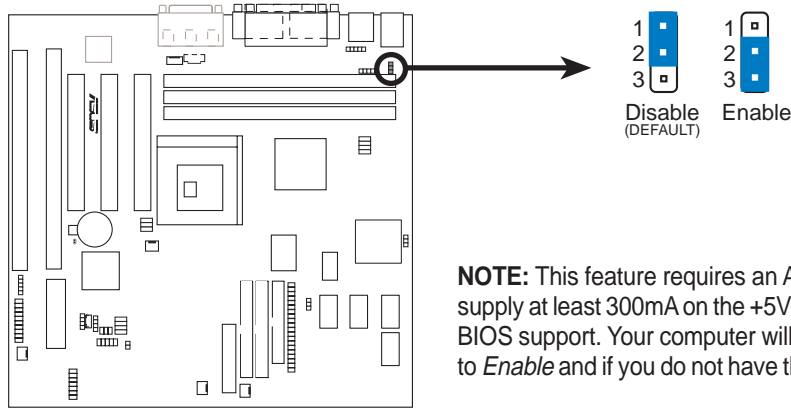

NOTE: This feature requires an ATX power supply that can supply at least 300mA on the +5VSB lead and the new ACPI BIOS support. Your computer will not function if you set this to *Enable* and if you do not have the right ATX power supply.

P5A-VM Keyboard Power (Wake) Up

4. Voltage Input/Output Selection (VIO0, VIO1) /

5. Overclock Frequency Setting (OVER_FQ)

VIO0/VIO1 allow you to select the voltage supplied to the DRAM, chipset, AGP, and the CPU's I/O buffer. When enabled, OVER_FQ allows you to increase the voltage supplied by 0.2V. This jumper is disabled by default.

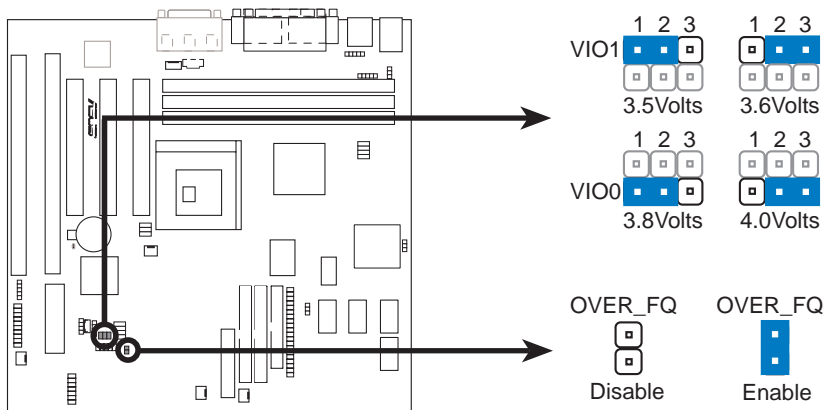

P5A-VM Voltage Input/Output Selection / Overclock Frequency Settings

WARNING! Overclocking may damage your CPU and cause your system to be unstable. Use only the specified frequency of your CPU.

III. INSTALLATION

6 CPU External (BUS) Frequency Selection (FS0, FS1, FS2, FS3)

These jumpers tell the clock generator what frequency to send to the CPU, chipset, and AGP. These allow the selection of the CPU's *External* frequency (or *BUS Clock*). The BUS Clock times the BUS Ratio equals the CPU's *Internal* frequency (the advertised CPU speed).

7. CPU to BUS Frequency Multiple (BF0, BF1, BF2)

These jumpers set the frequency ratio between the *Internal* frequency of the CPU and the *External* frequency (called the *BUS Clock*) within the CPU. These must be set together with the jumpers for *CPU External (BUS) Frequency Selection*.

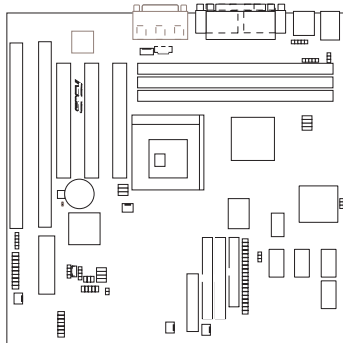

P5A-VM

Match the **Mult.** (Multiple) column of the table on the opposite page to these CPU types:

- CPU A:** AMD-K6-III, AMD-K6-2/400&faster
- CPU B:** AMD-K6-2/380&slower, AMD-K6
- CPU C:** Intel Pentium P54C, AMD-K5
- CPU D:** Intel Pentium P55C, IBM/Cyrix 6x86MX, IBM/Cyrix M II
- CPU E:** IBM/Cyrix 6x86, IBM/Cyrix 6x86L
- CPU F:** IDT WinChip 2™

	1	2	3	1	2	3	1	2	3	1	2	3	1	2	3
FS3	<input checked="" type="checkbox"/>	<input checked="" type="checkbox"/>	<input checked="" type="checkbox"/>	<input checked="" type="checkbox"/>	<input checked="" type="checkbox"/>	<input checked="" type="checkbox"/>	<input checked="" type="checkbox"/>	<input checked="" type="checkbox"/>	<input checked="" type="checkbox"/>	<input checked="" type="checkbox"/>	<input checked="" type="checkbox"/>	<input checked="" type="checkbox"/>	<input checked="" type="checkbox"/>	<input checked="" type="checkbox"/>	<input checked="" type="checkbox"/>
FS2	<input checked="" type="checkbox"/>	<input checked="" type="checkbox"/>	<input checked="" type="checkbox"/>	<input checked="" type="checkbox"/>	<input checked="" type="checkbox"/>	<input checked="" type="checkbox"/>	<input checked="" type="checkbox"/>	<input checked="" type="checkbox"/>	<input checked="" type="checkbox"/>	<input checked="" type="checkbox"/>	<input checked="" type="checkbox"/>	<input checked="" type="checkbox"/>	<input checked="" type="checkbox"/>	<input checked="" type="checkbox"/>	<input checked="" type="checkbox"/>
FS1	<input checked="" type="checkbox"/>	<input checked="" type="checkbox"/>	<input checked="" type="checkbox"/>	<input checked="" type="checkbox"/>	<input checked="" type="checkbox"/>	<input checked="" type="checkbox"/>	<input checked="" type="checkbox"/>	<input checked="" type="checkbox"/>	<input checked="" type="checkbox"/>	<input checked="" type="checkbox"/>	<input checked="" type="checkbox"/>	<input checked="" type="checkbox"/>	<input checked="" type="checkbox"/>	<input checked="" type="checkbox"/>	<input checked="" type="checkbox"/>
FS0	<input checked="" type="checkbox"/>	<input checked="" type="checkbox"/>	<input checked="" type="checkbox"/>	<input checked="" type="checkbox"/>	<input checked="" type="checkbox"/>	<input checked="" type="checkbox"/>	<input checked="" type="checkbox"/>	<input checked="" type="checkbox"/>	<input checked="" type="checkbox"/>	<input checked="" type="checkbox"/>	<input checked="" type="checkbox"/>	<input checked="" type="checkbox"/>	<input checked="" type="checkbox"/>	<input checked="" type="checkbox"/>	<input checked="" type="checkbox"/>
CPU →	60MHz	66.8MHz	75MHz	75MHz	83.3MHz	95MHz									
AGP →	60MHz	66.8MHz	75MHz	60MHz	66.6MHz	63.3MHz									
PCI →	30MHz	33.4MHz	37.5MHz	30MHz	33.3MHz	31.6MHz									

	1	2	3	1	2	3	1	2	3	1	2	3	1	2	3
FS3	<input checked="" type="checkbox"/>	<input checked="" type="checkbox"/>	<input checked="" type="checkbox"/>	<input checked="" type="checkbox"/>	<input checked="" type="checkbox"/>	<input checked="" type="checkbox"/>	<input checked="" type="checkbox"/>	<input checked="" type="checkbox"/>	<input checked="" type="checkbox"/>	<input checked="" type="checkbox"/>	<input checked="" type="checkbox"/>	<input checked="" type="checkbox"/>	<input checked="" type="checkbox"/>	<input checked="" type="checkbox"/>	<input checked="" type="checkbox"/>
FS2	<input checked="" type="checkbox"/>	<input checked="" type="checkbox"/>	<input checked="" type="checkbox"/>	<input checked="" type="checkbox"/>	<input checked="" type="checkbox"/>	<input checked="" type="checkbox"/>	<input checked="" type="checkbox"/>	<input checked="" type="checkbox"/>	<input checked="" type="checkbox"/>	<input checked="" type="checkbox"/>	<input checked="" type="checkbox"/>	<input checked="" type="checkbox"/>	<input checked="" type="checkbox"/>	<input checked="" type="checkbox"/>	<input checked="" type="checkbox"/>
FS1	<input checked="" type="checkbox"/>	<input checked="" type="checkbox"/>	<input checked="" type="checkbox"/>	<input checked="" type="checkbox"/>	<input checked="" type="checkbox"/>	<input checked="" type="checkbox"/>	<input checked="" type="checkbox"/>	<input checked="" type="checkbox"/>	<input checked="" type="checkbox"/>	<input checked="" type="checkbox"/>	<input checked="" type="checkbox"/>	<input checked="" type="checkbox"/>	<input checked="" type="checkbox"/>	<input checked="" type="checkbox"/>	<input checked="" type="checkbox"/>
FS0	<input checked="" type="checkbox"/>	<input checked="" type="checkbox"/>	<input checked="" type="checkbox"/>	<input checked="" type="checkbox"/>	<input checked="" type="checkbox"/>	<input checked="" type="checkbox"/>	<input checked="" type="checkbox"/>	<input checked="" type="checkbox"/>	<input checked="" type="checkbox"/>	<input checked="" type="checkbox"/>	<input checked="" type="checkbox"/>	<input checked="" type="checkbox"/>	<input checked="" type="checkbox"/>	<input checked="" type="checkbox"/>	<input checked="" type="checkbox"/>
CPU →	100MHz	105MHz	110MHz	115MHz	120MHz										
AGP →	66.6MHz	70MHz	73MHz	76.6MHz	80MHz										
PCI →	33.4MHz	35MHz	36.6MHz	38.3MHz	40MHz										

CPU External Clock (BUS) Frequency Selection

	1	2	3	1	2	3	1	2	3	1	2	3	1	2	3
BF2	<input checked="" type="checkbox"/>	<input checked="" type="checkbox"/>	<input checked="" type="checkbox"/>	<input checked="" type="checkbox"/>	<input checked="" type="checkbox"/>	<input checked="" type="checkbox"/>	<input checked="" type="checkbox"/>	<input checked="" type="checkbox"/>	<input checked="" type="checkbox"/>	<input checked="" type="checkbox"/>	<input checked="" type="checkbox"/>	<input checked="" type="checkbox"/>	<input checked="" type="checkbox"/>	<input checked="" type="checkbox"/>	<input checked="" type="checkbox"/>
BF1	<input checked="" type="checkbox"/>	<input checked="" type="checkbox"/>	<input checked="" type="checkbox"/>	<input checked="" type="checkbox"/>	<input checked="" type="checkbox"/>	<input checked="" type="checkbox"/>	<input checked="" type="checkbox"/>	<input checked="" type="checkbox"/>	<input checked="" type="checkbox"/>	<input checked="" type="checkbox"/>	<input checked="" type="checkbox"/>	<input checked="" type="checkbox"/>	<input checked="" type="checkbox"/>	<input checked="" type="checkbox"/>	<input checked="" type="checkbox"/>
BF0	<input checked="" type="checkbox"/>	<input checked="" type="checkbox"/>	<input checked="" type="checkbox"/>	<input checked="" type="checkbox"/>	<input checked="" type="checkbox"/>	<input checked="" type="checkbox"/>	<input checked="" type="checkbox"/>	<input checked="" type="checkbox"/>	<input checked="" type="checkbox"/>	<input checked="" type="checkbox"/>	<input checked="" type="checkbox"/>	<input checked="" type="checkbox"/>	<input checked="" type="checkbox"/>	<input checked="" type="checkbox"/>	<input checked="" type="checkbox"/>
CPU A →	3.5x(7/2)	6.0x(6/1)	2.5x(5/2)	3.0x(3/1)	4.0x(4/1)	4.5x(9/2)	5.0x(5/1)	5.5x(11/2)							
CPU B →	3.5x(7/2)	2.0x(2/1)	2.5x(5/2)	3.0x(3/1)	4.0x(4/1)	4.5x(9/2)	5.0x(5/1)	5.5x(11/2)							
CPU C →	1.5x(3/2)	2.0x(2/1)	2.5x(5/2)	3.0x(3/1)	—	—	—	—	—						
CPU D →	3.5x(7/2)	2.0x(2/1)	2.5x(5/2)	3.0x(3/1)	—	—	—	—	—						
CPU E →	3.0x(3/1)	2.0x(2/1)	1.0x(1/1)	—	—	—	—	—	—						
CPU F →	3.5x(7/2)	3.22x(10/3)	2.5x(5/2)	3.0x(3/1)	4.0x(4/1)	4.5x(9/2)	2.33x(7/3)	2.66x(8/3)							

CPU : BUS Frequency Multiple

WARNING! Frequencies above 100MHz exceed the specifications for the on-board chipset and are not guaranteed to be stable. The table on the following page is for general reference purposes only. Always refer to the instructions included with your CPU when possible.

NOTE: For updated processor settings, visit the ASUS web site (see **ASUS CONTACT INFORMATION** for URLs).

III. INSTALLATION

Set the jumpers by the Internal speed of your CPU as follows:

CPU Model	Freq.	Mult.	(BUS Freq.)				(Freq. Mult.)			
			BUS F.	FS3	FS2	FS1	FS0	BF2	BF1	BF0
AMD-K6-III/450	450MHz	A-4.5x	100MHz	[2-3]	[1-2]	[1-2]	[1-2]	[2-3]	[2-3]	[2-3]
AMD-K6-III/400	400MHz	A-4.0x	100MHz	[2-3]	[1-2]	[1-2]	[1-2]	[2-3]	[1-2]	[2-3]
AMD-K6-2/475	475MHz	A-5.0x	95MHz	[2-3]	[1-2]	[1-2]	[2-3]	[2-3]	[2-3]	[1-2]
AMD-K6-2/450	450MHz	A-4.5x	100MHz	[2-3]	[1-2]	[1-2]	[1-2]	[2-3]	[2-3]	[2-3]
AMD-K6-2/400	400MHz	A-4.0x	100MHz	[2-3]	[1-2]	[1-2]	[1-2]	[2-3]	[1-2]	[2-3]
AMD-K6-2/380	380MHz	B-4.0x	95MHz	[2-3]	[1-2]	[1-2]	[2-3]	[2-3]	[1-2]	[2-3]
AMD-K6-2/366	366MHz	B-5.5x	66MHz	[2-3]	[2-3]	[2-3]	[1-2]	[2-3]	[1-2]	[1-2]
AMD-K6-2/350	350MHz	B-3.5x	100MHz	[2-3]	[1-2]	[1-2]	[1-2]	[----]	[1-2]	[1-2]
AMD-K6-2/333	333MHz	B-3.5x	95MHz	[2-3]	[1-2]	[1-2]	[2-3]	[----]	[1-2]	[1-2]
AMD-K6-2/300	300MHz	B-3.0x	100MHz	[2-3]	[1-2]	[1-2]	[1-2]	[----]	[2-3]	[1-2]
AMD-K6-2/266	266MHz	B-4.0x	66MHz	[2-3]	[2-3]	[2-3]	[1-2]	[2-3]	[1-2]	[2-3]
AMD-K6/300	300MHz	B-4.5x	66MHz	[2-3]	[2-3]	[2-3]	[1-2]	[2-3]	[2-3]	[2-3]
AMD-K6/266	266MHz	B-4.0x	66MHz	[2-3]	[2-3]	[2-3]	[1-2]	[2-3]	[1-2]	[2-3]
AMD-K6/233	233MHz	B-3.5x	66MHz	[2-3]	[2-3]	[2-3]	[1-2]	[----]	[1-2]	[1-2]
AMD-K6/200	200MHz	B-3.0x	66MHz	[2-3]	[2-3]	[2-3]	[1-2]	[----]	[2-3]	[1-2]
AMD-K6/166	166MHz	B-2.5x	66MHz	[2-3]	[2-3]	[2-3]	[1-2]	[----]	[2-3]	[2-3]
AMD-K5/133	100MHz	C-1.5x	66MHz	[2-3]	[2-3]	[2-3]	[1-2]	[----]	[1-2]	[1-2]
AMD-K5/120	90MHz	C-1.5x	60MHz	[2-3]	[2-3]	[2-3]	[2-3]	[----]	[1-2]	[1-2]
AMD-K5/100	100MHz	C-1.5x	66MHz	[2-3]	[2-3]	[2-3]	[1-2]	[----]	[1-2]	[1-2]
AMD-K5/90	90MHz	C-1.5x	60MHz	[2-3]	[2-3]	[2-3]	[2-3]	[----]	[1-2]	[1-2]
Intel Pentium P54C	166MHz	C-2.5x	66MHz	[2-3]	[2-3]	[2-3]	[1-2]	[----]	[2-3]	[2-3]
Intel Pentium P54C	150MHz	C-2.5x	60MHz	[2-3]	[2-3]	[2-3]	[2-3]	[----]	[2-3]	[2-3]
Intel Pentium P54C	133MHz	C-2.0x	66MHz	[2-3]	[2-3]	[2-3]	[1-2]	[----]	[1-2]	[2-3]
Intel Pentium P54C	120MHz	C-2.0x	60MHz	[2-3]	[2-3]	[2-3]	[2-3]	[----]	[1-2]	[2-3]
Intel Pentium P54C	100MHz	C-1.5x	66MHz	[2-3]	[2-3]	[2-3]	[1-2]	[----]	[1-2]	[1-2]
Intel Pentium P54C	90MHz	C-1.5x	60MHz	[2-3]	[2-3]	[2-3]	[2-3]	[----]	[1-2]	[1-2]
Intel Pentium P55C	233MHz	D-3.5x	66MHz	[2-3]	[2-3]	[2-3]	[1-2]	[----]	[1-2]	[1-2]
Intel Pentium P55C	200MHz	D-3.0x	66MHz	[2-3]	[2-3]	[2-3]	[1-2]	[----]	[2-3]	[1-2]
Intel Pentium P55C	166MHz	D-2.5x	66MHz	[2-3]	[2-3]	[2-3]	[1-2]	[----]	[2-3]	[2-3]
IBM/Cyrix M II-PR333	333MHz	D-3.0x	83MHz	[2-3]	[1-2]	[2-3]	[1-2]	[----]	[2-3]	[1-2]
IBM/Cyrix M II-PR300	300MHz	D-3.0x	75MHz	[2-3]	[2-3]	[1-2]	[1-2]	[----]	[2-3]	[1-2]
IBM/Cyrix M II-PR300	300MHz	D-3.5x	66MHz	[2-3]	[2-3]	[2-3]	[1-2]	[----]	[1-2]	[1-2]
IBM/Cyrix 6x86MX-PR233	200MHz	D-3.0x	66MHz	[2-3]	[2-3]	[2-3]	[1-2]	[----]	[2-3]	[1-2]
IBM/Cyrix 6x86MX-PR200	166MHz	D-2.5x	66MHz	[2-3]	[2-3]	[2-3]	[1-2]	[----]	[2-3]	[2-3]
IBM/Cyrix 6x86MX-PR166	150MHz	D-2.5x	60MHz	[2-3]	[2-3]	[2-3]	[2-3]	[----]	[2-3]	[2-3]
IBM/Cyrix 6x86-PR166+*	133MHz	E-2.0x	66MHz	[2-3]	[2-3]	[2-3]	[1-2]	[----]	[1-2]	[2-3]
IBM/Cyrix 6x86L-PR166+*	133MHz	E-2.0x	66MHz	[2-3]	[2-3]	[2-3]	[1-2]	[----]	[1-2]	[2-3]
IDT WinChip 2™	240MHz	F-4.0x	60MHz	[2-3]	[2-3]	[2-3]	[2-3]	[2-3]	[1-2]	[2-3]
IDT WinChip 2™	225MHz	F-3.0x	75MHz	[2-3]	[2-3]	[1-2]	[1-2]	[----]	[2-3]	[1-2]
IDT WinChip 2™	200MHz	F-3.0x	66MHz	[2-3]	[2-3]	[2-3]	[1-2]	[---]	[2-3]	[1-2]

*The only IBM or Cyrix 6x86(L) (or M1) that is supported on this motherboard is revision 2.7 or later (see next page).

III. INSTALLATION

Compatible Cyrix CPU Identification

The only Cyrix 6x86-PR166+ CPU that is supported on this motherboard must be Revision 2.7 or later. Look on the underside of the CPU for the serial number. The number should read G8DC6620A or later.

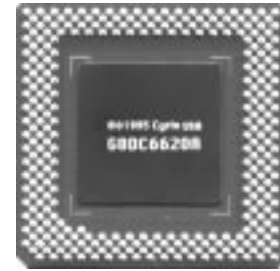

8. Voltage Regulator Output Selection (VID0, VID1, VID2, VID3)

These jumpers set the VCORE voltage supplied to the CPU. Switching regulators allow some jumper settings to be the same for two voltages of different power planes.

WARNING! Because CPU designs change rapidly, the table below is only intended as a simple guideline and thus may not be true for your CPU. Always refer to the CPU documentation for your CPU's voltage and then set the appropriate VID jumpers according to the illustration below.

Manufacturer	CPU Type	Single Plane	Dual Plane	VID3	VID2	VID1	VID0
AMD (.25micron)	K6-III/400,450 K6-2/450,475	----	2.4V(Dual)	[1-2]	[2-3]	[1-2]	[1-2]
AMD (.25micron)	K6-2/266,300,333 350,366,380,400 K6/233,266,300	----	2.2V(Dual)	[1-2]	[1-2]	[2-3]	[1-2]
AMD	K5	3.5V(VRE)	----	[2-3]	[2-3]	[2-3]	[2-3]
IBM/Cyrix	6x86	3.5V(VRE)	----	[2-3]	[2-3]	[2-3]	[2-3]
IDT	WinChip2	3.5V(VRE)	----	[2-3]	[2-3]	[2-3]	[2-3]
Intel	P54C/P54CS	3.5V(VRE)	----	[2-3]	[2-3]	[2-3]	[2-3]
AMD	K5	3.4V(STD)	----	[2-3]	[2-3]	[2-3]	[1-2]
Intel	P54C/P54CS	3.4V(STD)	---	[2-3]	[2-3]	[2-3]	[1-2]
AMD (.35micron)	K6-233	----	3.2V(Dual)	[2-3]	[2-3]	[1-2]	[1-2]
AMD (.35micron)	K6-166,200	----	2.9V(Dual)	[2-3]	[1-2]	[1-2]	[2-3]
IBM/Cyrix	6x86MX	----	2.9V(Dual)	[2-3]	[1-2]	[1-2]	[2-3]
Intel	P55C-MMX	----	2.8V(Dual)	[2-3]	[1-2]	[1-2]	[1-2]

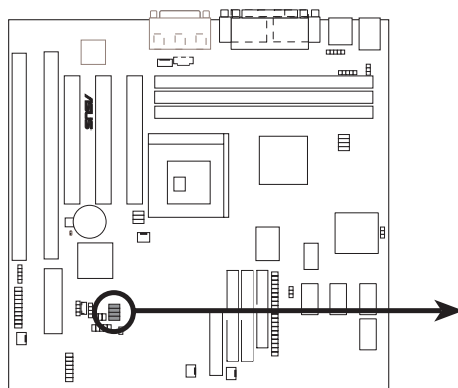

P5A-VM CPU Core Voltage Selection

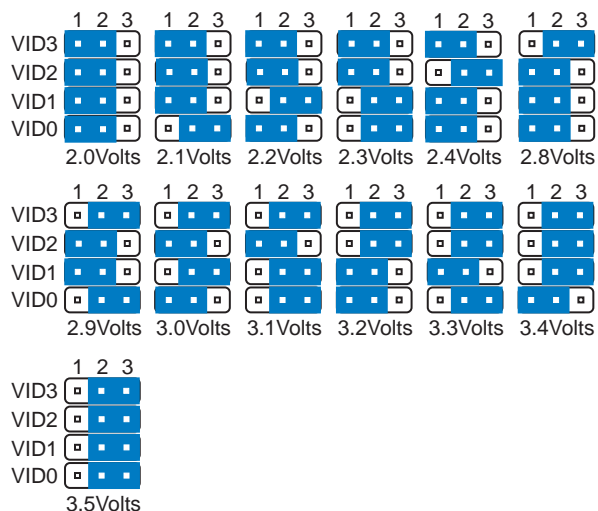

III. INSTALLATION

9. Real Time Clock (RTC) RAM (RTCCLR)

The CMOS RAM is powered by an onboard button cell battery. To clear the RTC data, (1) Turn off your computer, (2) Short solder points momentarily using a small metallic object, (3) Turn on your computer, (4) Hold down <Delete> during bootup and enter BIOS setup to re-enter user preferences.

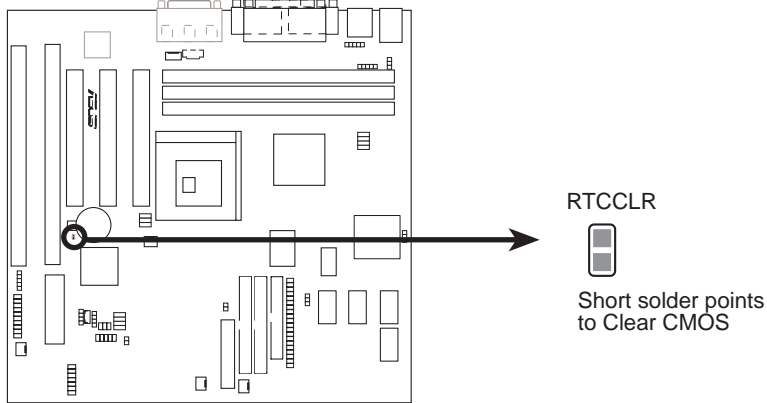

P5A-VM Clear RTC RAM

III. INSTALLATION

2. System Memory (DIMM)

This motherboard uses only Dual Inline Memory Modules (DIMMs). Sockets are available for **3.3Volt** (power level) unbuffered Synchronous Dynamic Random Access Memory (SDRAM) of either 8, 16, 32, 64, 128MB, or 256MB to form a memory size between 8MB and 768MB. One side (with memory chips) of the DIMM takes up one row on the motherboard.

To utilize the chipset's Error Checking and Correction (ECC) feature, you must use a DIMM module with 9 chips per side (standard 8 chips/side + 1 ECC chip) and make the proper settings through "Chipset Features Setup" in BIOS setup.

Memory speed setup is recommended through *SDRAM Configuration* under "Chipset Features Setup" in BIOS setup.

IMPORTANT (see **General DIMM Notes** below)

- **To make using bus speeds $\geq 95\text{MHz}$ possible, SDRAMs used must be compatible with the current Intel PC100 SDRAM specification..**

Install memory in any combination as follows:

DIMM Location	168-pin DIMM		Total Memory
Socket 1 (Rows 0&1)	SDRAM 8, 16, 32, 64, 128, 256MB	x1	
Socket 2 (Rows 2&3)	SDRAM 8, 16, 32, 64, 128, 256MB	x1	
Socket 3 (Rows 4&5)	SDRAM 8, 16, 32, 64, 128, 256MB	x1	
	Total System Memory (Max 768MB)	=	

NOTES

- At the time this User's Manual was written, 256MB DIMMs are available either as registered memory or 128Mbit DIMMs.
- **DIMMs that have more than 18 chips are not supported on this motherboard.**
- **For the system CPU bus to operate $\geq 95\text{MHz}$, use only PC100-compliant DIMMs.** When this motherboard operates at $\geq 95\text{MHz}$, most system will not even boot if non-compliant modules are used because of the strict timing issues involved under these speeds. If your DIMMs are not PC100-compliant, set the CPU bus frequency to 66MHz for system stability.
- ASUS motherboards support SPD (Serial Presence Detect) DIMMs. This is the memory of choice for best performance vs. stability.
- SDRAM chips are generally thinner with higher pin density than EDO (Extended Data Output) chips.
- BIOS shows SDRAM memory on bootup screen.
- Single-sided DIMMs come in 16, 32, 64, 128MB; double-sided come in 32, 64, 128, 256MB.

III. INSTALLATION

DIMM Memory Installation Procedures:

Insert the module(s) as shown. Because the number of pins are different on either side of the breaks, the module will only fit in the orientation as shown. DRAM SIMM modules have the same pin contacts on both sides. SDRAM DIMMs have different pin contacts on each side and therefore have a higher pin density.

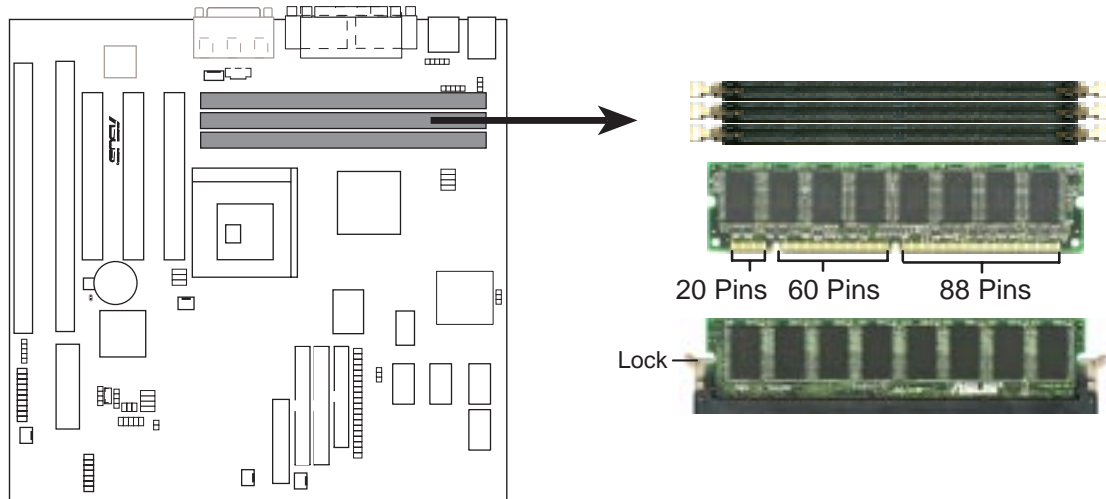

P5A-VM 168-Pin DIMM Sockets

III. INSTALLATION
System Memory

The DIMMs must be 3.3Volt unbuffered SDRAMs. To determine the DIMM type, check the notches on the DIMMs (see figure below).

168-Pin DIMM Notch Key Definitions (3.3V)

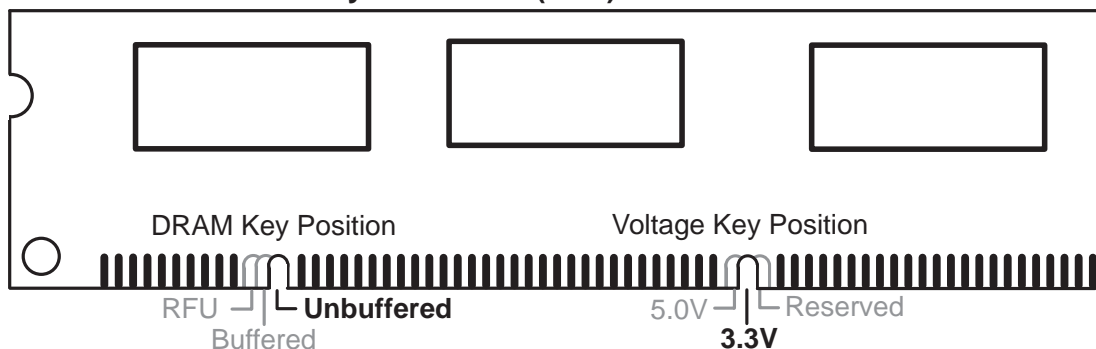

The notches on the DIMM will shift between left, center, or right to identify the type and also prevent the wrong type from being inserted into the DIMM slot on the motherboard. You must tell your retailer the correct DIMM type before purchasing. This motherboard supports four clock signals.

III. INSTALLATION

3. Central Processing Unit (CPU)

The motherboard provides a 321-pin ZIF Socket 7 that is backwards compatible with ZIF Socket 5 processors. The CPU that came with the motherboard should have a fan attached to it to prevent overheating. If this is not the case then purchase a fan before you turn on your system.

WARNING! Without a fan circulating air on the CPU, the CPU can overheat and cause damage to both the CPU and the motherboard.

To install a CPU, first turn off your system and remove its cover. Locate the ZIF socket and open it by first pulling the lever sideways away from the socket then upwards to a 90-degree right angle. Insert the CPU with the correct orientation as shown. Use the notched corner of the CPU with the white dot as your guide. The white dot should point toward the end of the lever. Notice that there is a blank area where one hole is missing from that corner of the square array of pin holes and a “1” printed on the motherboard next to that corner. Because the CPU has a corner pin for three of the four corners, the CPU will only fit in the one orientation as shown. The picture is for reference only; you should have a CPU fan that will cover the face of the CPU. With the added weight of the CPU fan, no force is required to insert the CPU. Once completely inserted, hold down on the fan and close the socket’s lever.

IMPORTANT: You must set jumpers for “CPU to BUS Frequency Ratio” and jumpers for “BUS Frequency Selection” depending on the CPU that you install.

CAUTION! Be careful not to scrape the motherboard when mounting a clamp-style processor fan or else damage may occur to the motherboard.

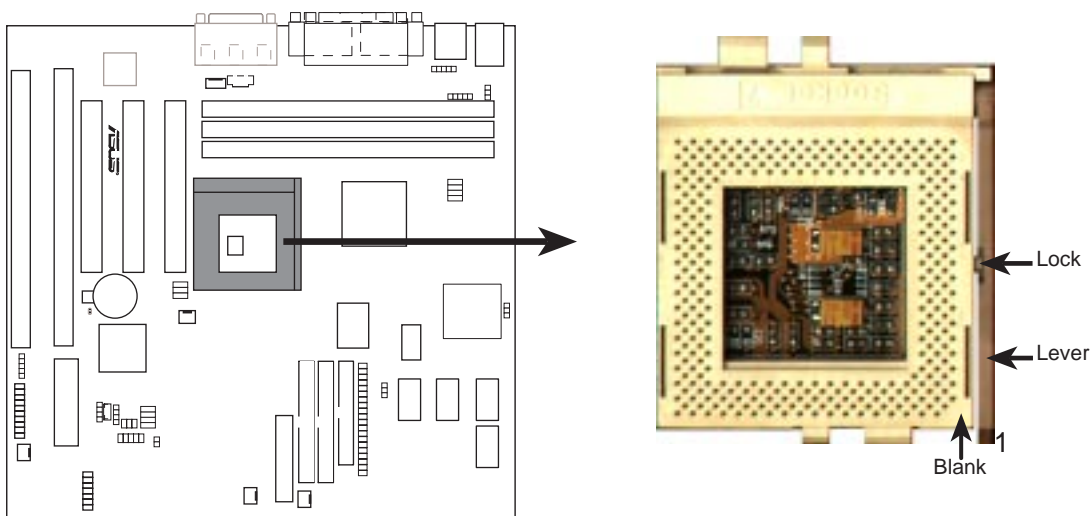

P5A-VM ZIF Socket 7

III. INSTALLATION

4. Expansion Cards

WARNING! Make sure that you unplug your power supply when adding or removing expansion cards or other system components. Failure to do so may cause severe damage to both your motherboard and expansion cards.

Expansion Card Installation Procedure:

1. Read your expansion card documentation on any hardware and software settings that may be required to setup your specific card.
2. Set any necessary jumpers on your expansion card.
3. Remove your computer system's cover.
4. Remove the bracket on the slot you intend to use.
Keep the bracket for possible future use.
5. Carefully align the card's connectors and press firmly.
6. Secure the card on the slot with the screw you removed in step 4.
7. Replace the computer system's cover.
8. Setup the BIOS if necessary
(such as "IRQ xx Used By ISA: Yes" in PNP AND PCI SETUP)
9. Install the necessary software drivers for your expansion card.

Assigning IRQs for Expansion Cards

Some expansion cards need to use an IRQ to operate. Generally an IRQ must be exclusively assigned to one use. In a standard design there are 16 IRQs available but most of them are already in use by parts of the system which leaves 6 free for expansion cards.

Both ISA and PCI expansion cards may need to use IRQs. System IRQs are available to cards installed in the ISA expansion bus first, and any remaining IRQs are then used by PCI cards. Currently, there are two types of ISA cards.

The original ISA expansion card design, now referred to as "Legacy" ISA cards, requires that you configure the card's jumpers manually and then install it in any available slot on the ISA bus. You may use Microsoft's Diagnostic (MSD.EXE) utility included in the Windows directory to see a map of your used and free IRQs. For Windows 95 users, the "Control Panel" icon in "My Computer," contains a "System" icon, which gives you a "Device Manager" tab. Double clicking on a specific device give you "Resources" tab which shows the Interrupt number and address. Make sure that no two devices use the same IRQs or your computer will experience problems when those two devices are in use at the same time.

III. INSTALLATION

To simplify this process, this motherboard complies with the Plug and Play (PNP) specification which was developed to allow automatic system configuration whenever a PNP-compliant card is added to the system. For PNP cards, IRQs are assigned automatically from those available.

If the system has both Legacy and PNP ISA cards installed, IRQs are assigned to PNP cards from those not used by Legacy cards. The PCI and PNP configuration of the BIOS setup utility can be used to indicate which IRQs are being used by Legacy cards. For older Legacy cards that do not work with the BIOS, you can contact your vendor for an ISA Configuration Utility.

An IRQ number is automatically assigned to PCI expansion cards after those used by Legacy and PNP ISA cards. In the PCI bus design, the BIOS automatically assigns an IRQ to a PCI slot that has a card in it that requires an IRQ. To install a PCI card, you need to set something called the INT (interrupt) assignment. Since all the PCI slots on this motherboard use an INTA #, be sure that the jumpers on your PCI cards are set to INT A.

Assigning DMA Channels for ISA Cards

Some ISA cards, both legacy and PnP, may also need to use a DMA (Direct Memory Access) channel. DMA assignments for this motherboard are handled the same way as the IRQ assignment process described earlier. You can select a DMA channel in the PCI and PnP configuration section of the BIOS Setup utility.

IMPORTANT: To avoid conflicts, reserve the necessary IRQs and DMAs for legacy ISA cards (under PNP AND PCI SETUP of the BIOS SOFTWARE, choose *Yes* in *IRQ xx Used By ISA* and *DMA x Used By ISA* for those IRQs and DMAs you want to reserve).

ISA Cards and Hardware Monitor

The onboard hardware monitor uses the address 290H-297H, so legacy ISA cards must not use this address or else conflicts will occur.

III. INSTALLATION

5. External Connectors

WARNING! Some pins are used for connectors or power sources. These are clearly separated from jumpers in the Motherboard Layout. Placing jumper caps over these will cause damage to your motherboard.

IMPORTANT: Ribbon cables should always be connected with the red stripe to Pin 1 on the connectors. Pin 1 is usually on the side closest to the power connector on hard drives and CD-ROM drives, but may be on the opposite side on floppy disk drives. Check the connectors before installation because there may be exceptions. IDE ribbon cables must be less than 46 cm (18 in.), with the second drive connector no more than 15 cm (6 in.) from the first connector.

1. PS/2 Keyboard Connector (6-pin Female)

This connection is for a standard keyboard using an PS/2 plug (mini DIN). **This connector will not allow standard AT size (large DIN) keyboard plugs. You may use a DIN to mini DIN adapter on standard AT keyboards.**

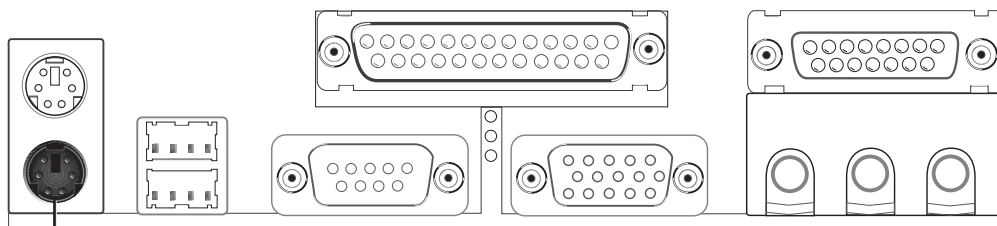

PS/2 Keyboard (6-pin Female)

2. PS/2 Mouse Connector (6-pin Female)

The system will direct IRQ12 to the PS/2 mouse if one is detected. If not detected, expansion cards can use IRQ12. See “PS/2 Mouse Control” in BIOS Features Setup of the BIOS SOFTWARE.

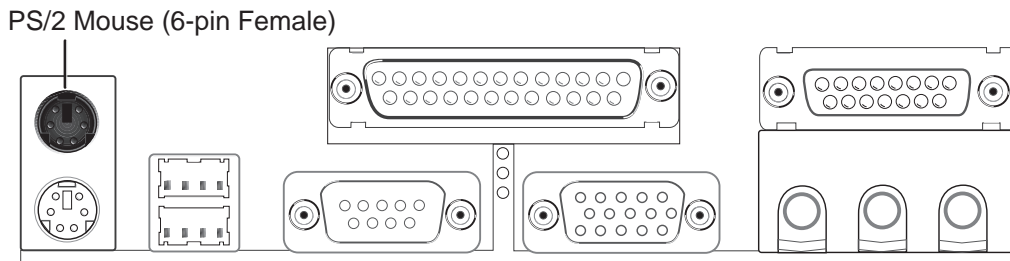

PS/2 Mouse (6-pin Female)

III. INSTALLATION

3. Parallel Port Connector (25-pin Female)

You can enable the parallel port and choose the IRQ through “Onboard Parallel Port” in Chipset Features Setup of the BIOS SOFTWARE.

NOTE: Serial printers must be connected to the serial port.

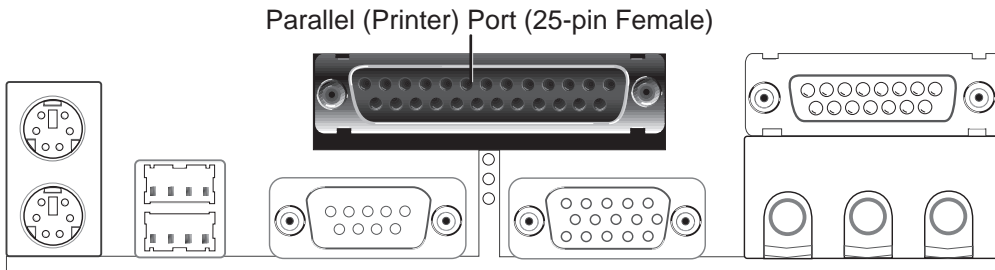

4. Serial Port COM1 (9-pin Male) and COM2 Connectors (10-1 pin Male)

The two serial ports can be used for pointing devices or other serial devices. COM1 is ready for use while COM2 requires a serial port bracket connected from the motherboard to an expansion slot opening. For setting these ports up, see “Onboard Serial Port” in Chipset Features Setup of the BIOS SOFTWARE.

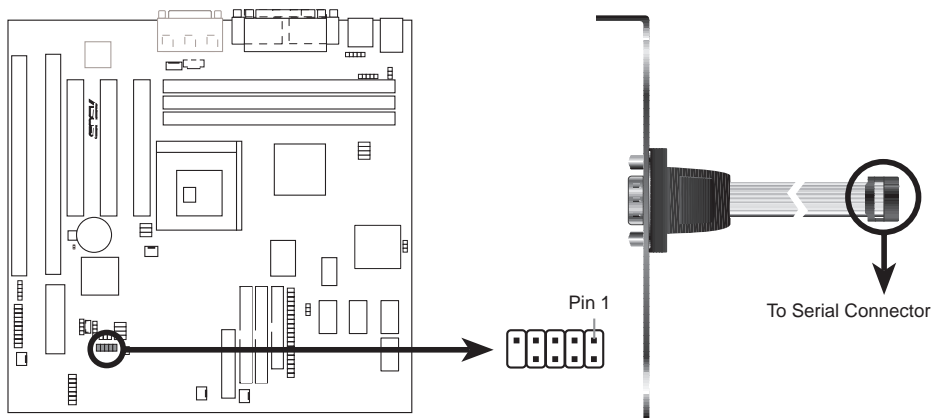
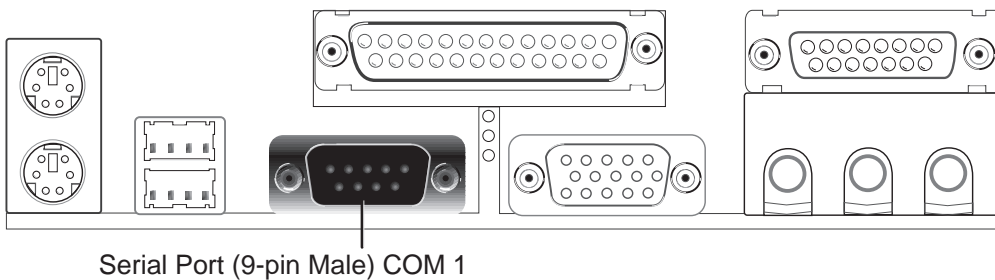

P5A-VM Serial COM 2 Connector

III. INSTALLATION

5. Monitor (VGA) Output Connector (15-pin Female)

This connector is for output to a VGA-compatible device.

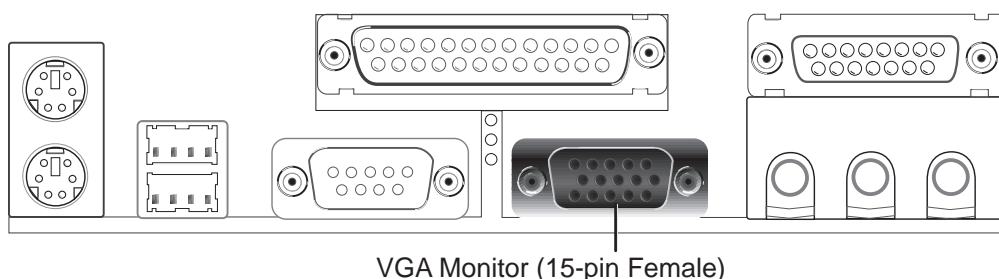

6. Floppy drive connector (FLOPPY, 34-1 pin block)

This connector supports the provided floppy drive ribbon cable. After connecting the single end to the board, connect the two plugs on the other end to the floppy drives. **(Pin 5 is removed to prevent inserting in the wrong orientation when using ribbon cables with pin 5 plugged).**

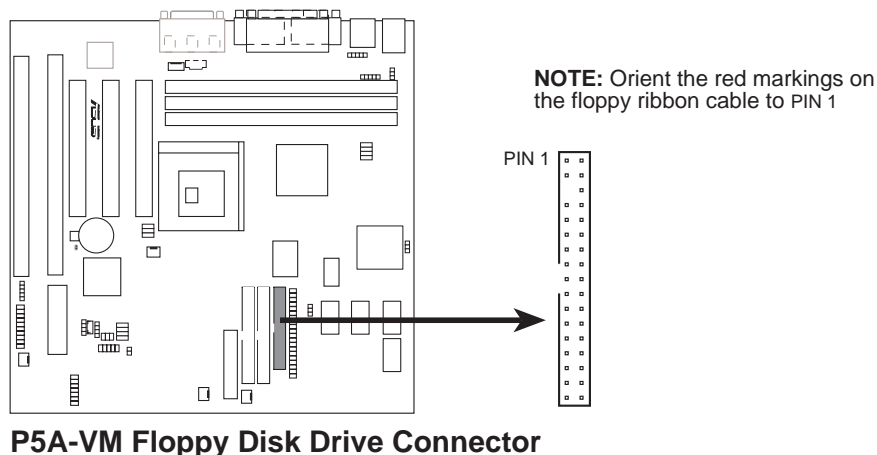

7. Audio Port Connectors (Three 1/8" Female) (with optional onboard audio)

Line Out can be connected to headphones or preferably powered speakers. **Line In** allows tape players or other audio sources to be recorded by your computer or played through the **Line Out**. **Mic** allows microphones to be connected for inputting voice.

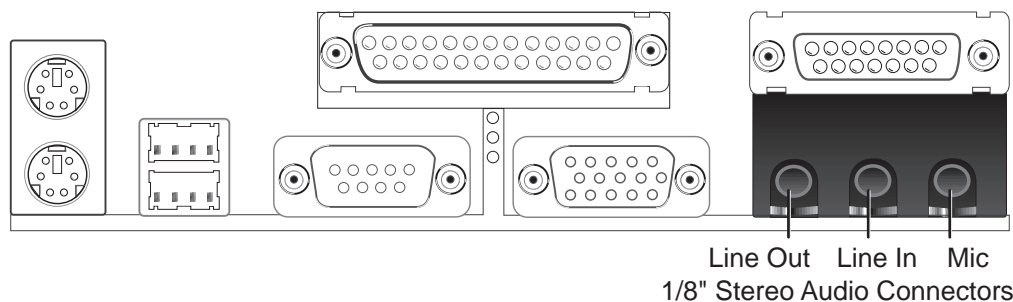

III. INSTALLATION

8. **Joystick/Midi Connector (15-pin Female)** (with optional onboard audio)
You may connect game joysticks or game pads to this connector for playing games. Connect Midi devices for playing or editing audio.

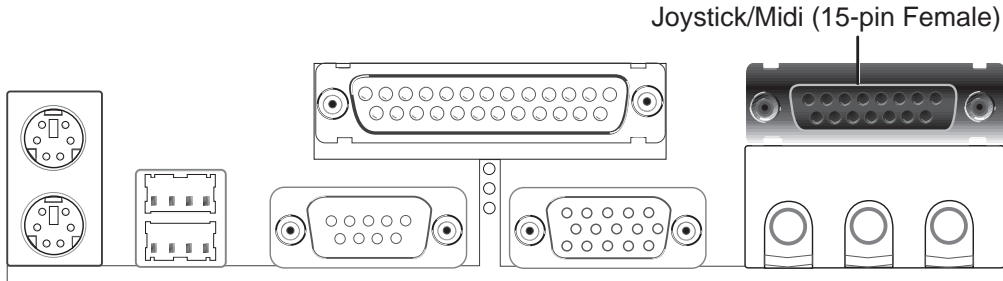

9. **Universal Serial BUS Ports 1 & 2 (Two 4-pin Female Sockets)**
Two USB ports are available for connecting USB devices.

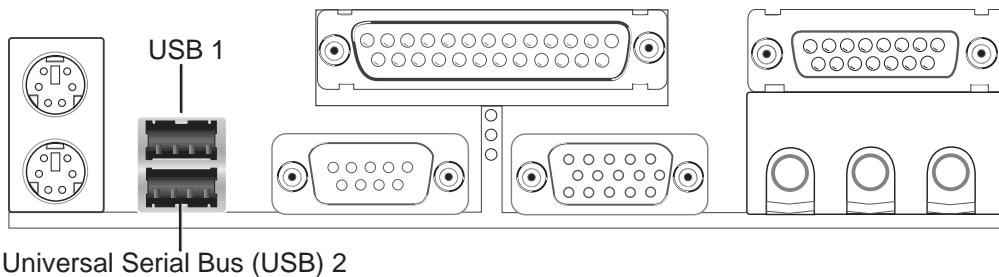

10. **Primary / Secondary IDE connectors (Two 40-1 pin block)**

These connectors support the provided IDE hard disk ribbon cable. After connecting the single end to the board, connect the two plugs at the other end to your hard disk(s). If you install two hard disks on the same channel, you must set the second drive to Slave mode. Refer to the documentation of your hard disk for the jumper settings. BIOS now supports SCSI device or IDE CD-ROM bootup (see *HDD Sequence SCSI/IDE First & Boot Sequence* in **BIOS Features Setup** of the BIOS SOFTWARE) (**Pin 20 is removed to prevent inserting in the wrong orientation when using ribbon cables with pin 20 plugged**).

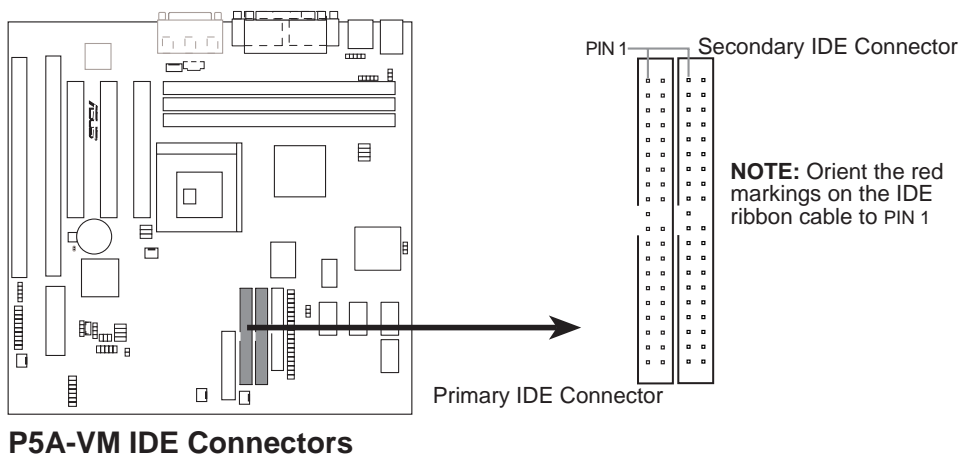

III. INSTALLATION

TIP: You may configure two hard disks to be both Master drives using one ribbon cable on the primary IDE connector and another ribbon cable on the secondary IDE connector. You may install one operating system on an IDE drive and another on a SCSI drive and select the boot disk through the BIOS features Setup.

11. Chassis Intrusion Alarm Lead (4-1 pin CHASIS)

This requires an external detection mechanism such as a chassis intrusion monitor/sensor or microswitch. The sensor is triggered when a high level signal is sent to the CHASIS lead. This occurs when the side panel is opened or drive bay doors are opened.

NOTE: When the chassis is opened, connect/short the Chassis Signal pin to the +5VSB pin. When the chassis is closed, connect/short the Chassis Signal pin to the Ground pin.

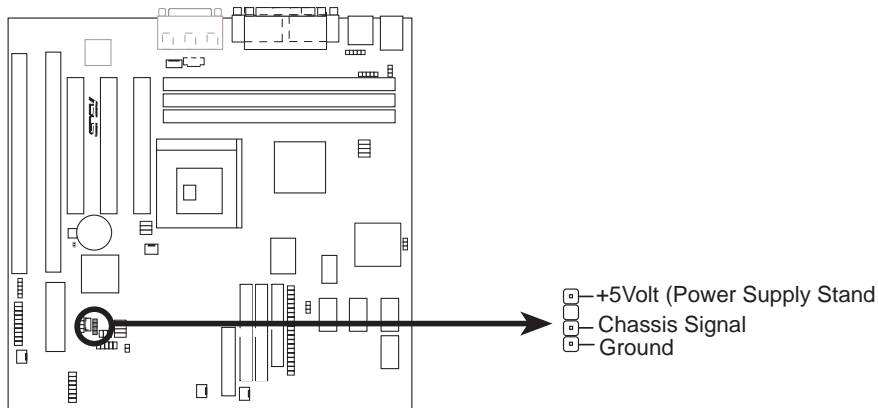

P5A-VM Chassis Open Alarm Lead

III. INSTALLATION

12. ATX Power Supply Connector (ATX, 20-pin block)

This connector connects to a ATX power supply. The plug from the power supply will only insert in one orientation because of the different hole sizes. Find the proper orientation and push down firmly making sure that the pins are aligned.

IMPORTANT: Make sure that your ATX power supply can supply at least 10mA on the 5-volt standby lead (+5VSB). You may experience difficulty in powering on your system if your power supply cannot support the load. For Wake on LAN support, your ATX power supply must supply at least 720mA.

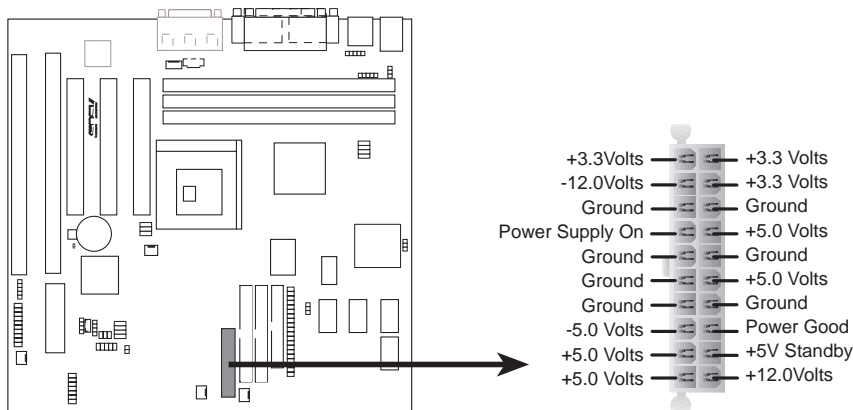

P5A-VM ATX Power Connector

13. IrDA/Fast IR-Compliant Infrared Module Connector (IR, 5-pin block)

This connector supports the optional wireless transmitting and receiving infrared module. This module mounts to a small opening on system cases that support this feature. You must also configure the setting through *UART2 Use Infrared* in **Chipset Features Setup** to select whether UART2 is directed for use with COM2 or IrDA. Use the five pins as shown below (Back View) and connect a ribbon cable from the module to the motherboard according to the pin definitions.

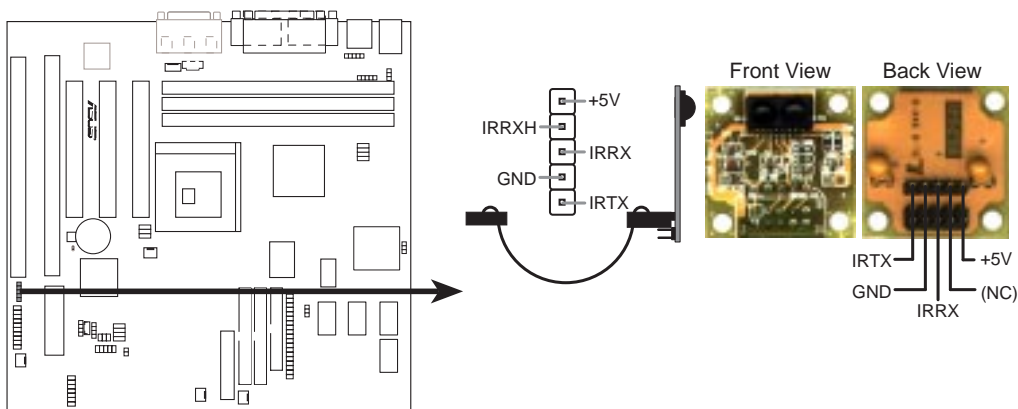

P5A-VM Infrared Module Connector

III. INSTALLATION

14 ATX Power Switch/Soft Power Switch Lead (PWR, 2 pins)

The system power can be controlled by a momentary switch connected to this lead. Pushing the button once will switch the system between ON and SLEEP. Pushing the switch while in the ON mode for more than 4 seconds will turn the system off. The system power LED shows the status of the system's power.

15. IDE Activity LED Lead (IDELED, 2 pins)

This connector supplies power to the cabinet's IDE activity LED. Read and write activity by devices connected to the Primary or Secondary IDE connectors will cause the LED to light up.

16. System Power LED Lead (PLED, 2 pins)

This 3-pin connector connects the system power LED, which lights when the system is powered on and blinks when it is in sleep mode.

17. Reset Switch Lead (RESET, 2 pins)

This 2-pin connector connects to the case-mounted reset switch for rebooting your computer without having to turn off your power switch. This is a preferred method of rebooting in order to prolong the life of the system's power supply.

18. Message LED Lead (MLED, 2 pins)

This indicates whether a message has been received from a fax/modem. The LED will remain lit when there is no signal and blink when there is data transfer or messages waiting in the inbox. This function requires ACPI OS support.

19. Keyboard Lock Switch Lead (KEYLOCK, 2 pins)

This 2-pin connector connects to the case-mounted key switch to allow keyboard locking.

20. Speaker Connector (SPEAKER, 4 pins)

This 4-pin connector connects to the case-mounted speaker.

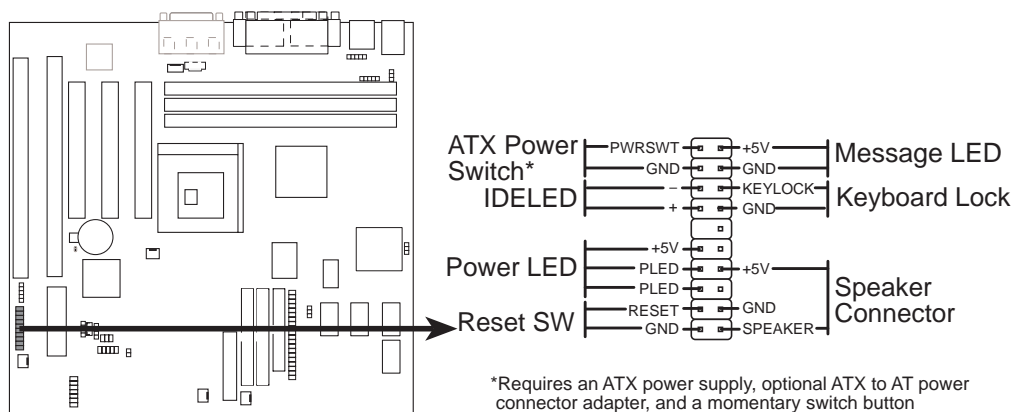

P5A-VM System Panel Connectors

III. INSTALLATION

21. Wake-on-LAN Activity Connector (3-pin WOLCON)

The WOLCON connector allows the system to power up when there is a wakeup packet or signal is received from the network through the ASUS PCI-L101 LAN card (see section VI. ASUS LAN CARD).

IMPORTANT: This feature requires that the **WAKE On LAN Power Up Control** is set to *Enabled* (see “Power Management Setup” under IV. BIOS SOFTWARE) and that your system has an ATX power supply with at least 720mA +5V standby power.

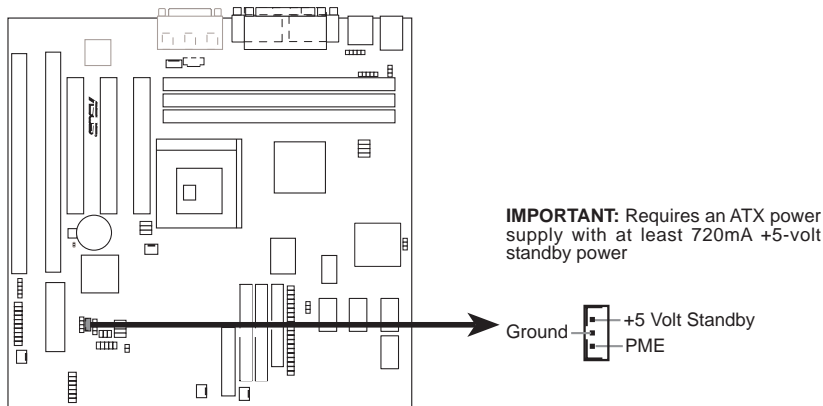

P5A-VM Wake-On-LAN Connector

22. Stereo Audio In Connector (4-pin CD_IN)x /

23. MODEM Card Voice In Connector (4-pin MODEM)

CD_IN allows you to receive stereo audio input from an internal CD-ROM drive or other sound sources, such as a TV tuner or MPEG card. MODEM allows mono input and output for a compatible voice modem microphone and speaker interface.

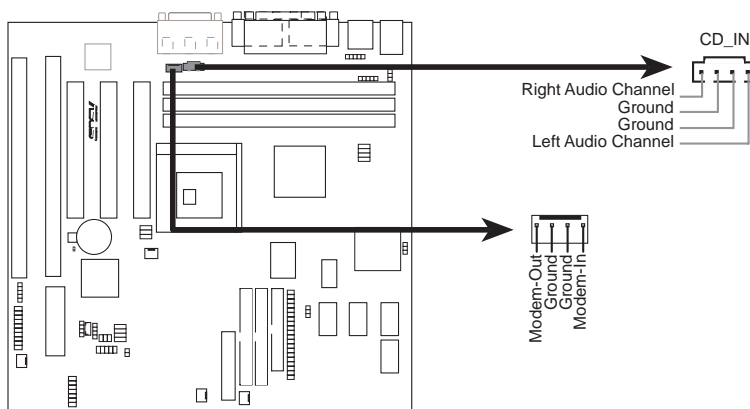

P5A-VM Stereo Audio In / Modem Card Voice In Connectors

III. INSTALLATION

24 SMBus Connector (5-1 pin SMB)

This connector allows you to connect SMBus devices. SMBus devices communicate by means of the SMBus with an SMBus host and/or other SMBus devices. The SMBus or System Management Bus is a specific implementation of an I²C bus, which is a multi-master bus, that is, multiple chips can be connected to the same bus and each one can act as a master by initiating data transfer.

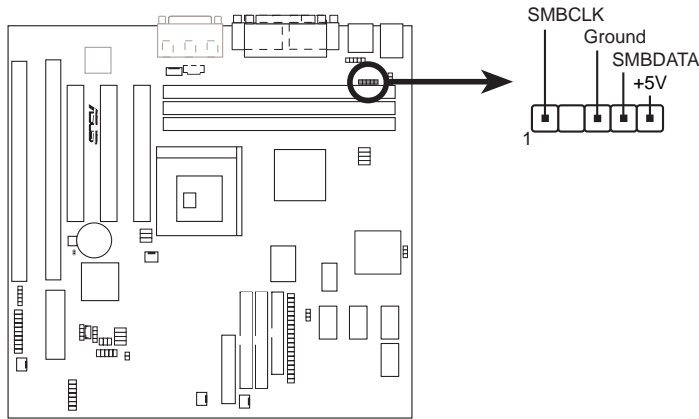

P5A-VM SMBus Connector

25. Power Supply Temperature External Connector (2 pin PWR_TMP)

This connector allows you to connect a compatible heat sensor to monitor the power supply temperature.

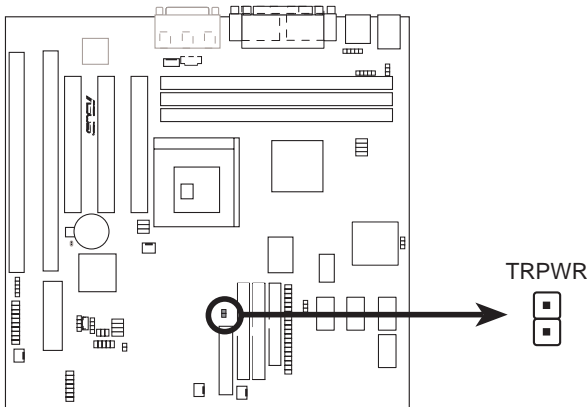

P5A-VM Power Supply Temperature External Connector

III. INSTALLATION

26. CPU Cooling Fan Connectors (FAN, 3 pins)

These connectors support 3-pin cooling fans of 500mA (6W) or less with a minimum of 3,500RPM. Orientate the fans so that the heatsink fins allow airflow to go across the onboard heatsink(s) instead of the expansion slots. Depending on the fan manufacturer, the wiring and plug may be different. The red wire should be positive, while the black should be ground. Connect the fan's plug to the board taking into consideration the polarity of the connector. **NOTE: The "Rotation" signal is to be used only by a specially designed fan with rotation signal. The Rotations per Minute (RPM) can be monitored using ASUS PC Probe Utility or Intel LDCM Utility.**

WARNING! The CPU and/or motherboard will overheat if there is no airflow across the CPU. Damage may occur to the motherboard and/or the CPU fan if these pins are incorrectly used. **These are not jumpers, thus, do not place jumper caps over these pins.**

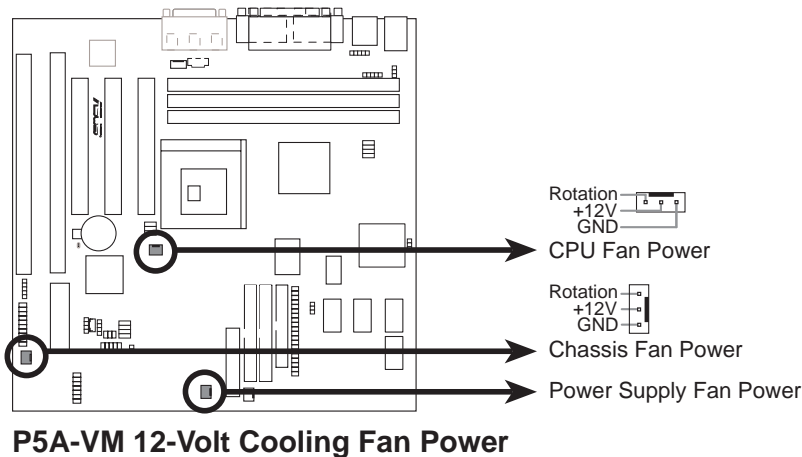

III. INSTALLATION

Power Connection Procedures

1. After all jumpers and connections are made, close the system case cover.
2. Be sure that all switches are off (in some systems, marked with ○).
3. Connect the power supply cord into the power supply located on the back of your system case according to your system user's manual.
4. Connect the power cord into a power outlet that is equipped with a surge protector.
5. You may then turn on your devices in the following order:
 - a. Your monitor
 - b. External SCSI devices (starting with the last device on the chain)
 - c. Your system power. For ATX power supplies, you need to switch on the power supply as well as press the ATX power switch on the front of the case.
6. The power LED on the front panel of the system case will light. For ATX power supplies, the system LED will light when the ATX power switch is pressed. The monitor LED may light up after the system's if it complies with "green" standards or if it has a power standby feature. The system will then run power-on tests. While the tests are running, additional messages will appear on the screen. If you do not see anything within 30 seconds from the time you turn on the power, the system may have failed a power-on test. Recheck your jumper settings and connections or call your retailer for assistance.
7. During power-on, hold down <Delete> to enter BIOS setup. Follow the instructions in the next section, BIOS SOFTWARE.

***Powering Off your computer:** You must first exit or shut down your operating system before switching off the power switch. For ATX power supplies, you can press the ATX power switch after exiting or shutting down your operating system. If you use Windows 95, click the **Start** button, click **Shut Down**, and then click **Shut down the computer?**. The system will give three quick beeps after about 30 seconds and then power off after Windows shuts down.

NOTE: The message "You can now safely turn off your computer" will not appear when shutting down with ATX power supplies.

IV. BIOS SOFTWARE

Support Software

AFLASH.EXE: This is the Flash Memory Writer utility that updates the BIOS by uploading a new BIOS file to the programmable flash ROM chip on the motherboard. To determine the BIOS version of your motherboard, check the last four numbers of the code displayed on the upper left-hand corner of your screen during bootup. Larger numbers represent a newer BIOS file. This file works only in DOS mode.

NOTE: The following screen displays are provided as examples only and may not reflect the screen contents displayed on your system.

Flash Memory Writer Utility

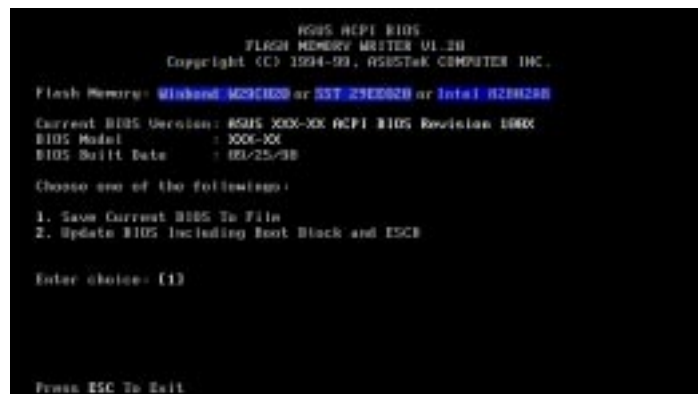

IMPORTANT! If “unknown” is displayed after **Flash Memory:**, the memory chip is either not programmable or is not supported by the ACPI BIOS and therefore, cannot be programmed by the Flash Memory Writer utility.

Main Menu

1. Save Current BIOS To File

This option allows you to save a copy of the original motherboard BIOS in case you need to reinstall it. It is recommended that you save **AFLASH.EXE** and the BIOS file to a bootable floppy disk.

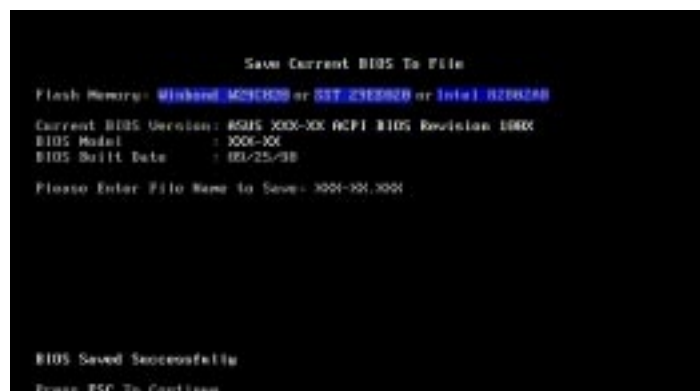

To save your current BIOS, type [1] at the **Main Menu** and then press <Enter>. The **Save Current BIOS To File** screen appears. Type a filename and the path, for example, **A:\440XX-1** and then press <Enter>.

IV. BIOS SOFTWARE

2. Update BIOS Including Boot Block and ESCD

This option updates the boot block, the baseboard BIOS, and the ACPI extended system configuration data (ESCD) parameter block from a new BIOS file. See the next page for procedures on downloading an updated BIOS file.

To update your current BIOS, type [2] at the **Main Menu** and then press <Enter>. The **Update BIOS Including Boot Block and ESCD** screen appears. Type the filename of your new BIOS and the path, for example, **A:\XX2I1002.AWD**, and then press <Enter>.

When prompted to confirm the BIOS update, press **Y** to start the update.

The utility starts to program the new BIOS information into the flash ROM. When the programming is finished, *Flashed Successfully* will be displayed.

Follow the onscreen instructions to continue.

```
Update BIOS Including Boot Block and ESCD
Flash Memory: Winbond W29C020 or SST 29E020 or Intel H29H200
Current BIOS Version: AG21 3000-XX ACPI BIOS Revision 1000
BIOS Model          : 3000-XX
BIOS Build Date     : 05/25/98
Please Enter File Name for NEW BIOS: A:\3000-XX300
```

```
Update BIOS Including Boot Block and ESCD
Flash Memory: Winbond W29C020 or SST 29E020 or Intel H29H200
BIOS Version
(CURRENT) : AG21 3000-XX ACPI BIOS Revision 1000
(Test.aud) AG21 3000-XX ACPI BIOS Revision 1000
BIOS Model
(CURRENT) : 3000-XX
(Test.aud) 3000-XX
Date of BIOS Build
(CURRENT) : 05/25/98
(D000,0000) 05/25/98
Notice: Boot Block is different, Check size of 1001,010 is F206.
Are you sure (Y/N) ? Y
```

```
Update BIOS Including Boot Block and ESCD
Flash Memory: Winbond W29C020 or SST 29E020 or Intel H29H200
BIOS Version
(CURRENT) : AG21 3000-XX ACPI BIOS Revision 1000
(Test.aud) AG21 3000-XX ACPI BIOS Revision 1000
BIOS Model
(CURRENT) : 3000-XX
(Test.aud) 3000-XX
Date of BIOS Build
(CURRENT) : 05/25/98
(D000,0000) 05/25/98
Notice: Boot Block is different, Check size of 1001,010 is F206.
Are you sure (Y/N) ? Y
Block Erasing -- Done
Programming -- 3FFFF
Flashed Successfully
Press ESC To Continue
```

```
AG21 ACPI BIOS
FLASH MEMORY WRITER 01.20
Copyright (C) 1994-99, ASUSTeK COMPUTER INC.
Flash Memory: Winbond W29C020 or SST 29E020 or Intel H29H200
Current BIOS Version: AG21 3000-XX ACPI BIOS Revision 1000
BIOS Model          : 3000-XX
BIOS Build Date     : 05/25/98
Choose one of the following:
1. Save Current BIOS To File
2. Update BIOS Including Boot Block and ESCD
Enter choice: [1]
You have flashed the EPROM. It is recommended that you turn off
the power, enter SETUP and Load Setup Defaults to have CMOS
updated with new BIOS when exits.
Press ESC To Exit
```

IV. BIOS
Flash Memory Writer

IV. BIOS SOFTWARE

Managing and Updating Your Motherboard's BIOS

Upon First Use of the Computer System

1. Create a bootable system floppy disk by typing [FORMAT A:/S] from the DOS prompt without creating "AUTOEXEC.BAT" and "CONFIG.SYS" files.
2. Copy AFLASH.EXE to the just created boot disk.
3. Run AFLASH.EXE from this new disk and select option **1. Save Current BIOS to File**. See **1. Save Current BIOS To File** on the previous page for more details and the rest of the steps.

Updating BIOS Procedures (only when necessary)

1. Download an updated ASUS BIOS file from the Internet (WWW or FTP) or a BBS (Bulletin Board Service) (see ASUS CONTACT INFORMATION on page 3 for details) and save to the disk you created earlier.
2. Boot from the disk you created earlier.
3. At the "A:\`" prompt, type **AFLASH** and then press <Enter>.
4. At the **Main Menu**, type **2** and then press <Enter>. See **2. Update BIOS Including Boot Block and ESCD** on the previous page for more details and the rest of the steps.

WARNING! If you encounter problems while updating the new BIOS, DO NOT turn off your system since this might prevent your system from booting up. Just repeat the process, and if the problem still persists, update the original BIOS file you saved to disk above. If the Flash Memory Writer utility was not able to successfully update a complete BIOS file, your system may not be able to boot up. If this happens, your system will need service.

IV. BIOS SOFTWARE

6. BIOS Setup

The motherboard supports 5-volt programmable 2-Mbit Flash ROM chips. These memory chips can be updated when BIOS upgrades are released. Use the Flash Memory Writer utility to download the new BIOS file into the ROM chip as described in detail in this section.

All computer motherboards provide a Setup utility program for specifying the system configuration and settings. If your motherboard came in a computer system, the proper configuration entries may have already been made. If so, invoke the Setup utility, as described later, and take note of the configuration settings for future reference; in particular, the hard disk specifications.

If you are installing the motherboard, reconfiguring your system or you receive a Run Setup message, you will need to enter new setup information. This section describes how to configure your system using this utility.

The BIOS ROM of the system stores the Setup utility. When you turn on the computer, the system provides you with the opportunity to run this program. This appears during the Power-On Self Test (POST). Press <Delete> to call up the Setup utility. If you are a little bit late pressing the mentioned key(s), POST will continue with its test routines, thus preventing you from calling up Setup. If you still need to call Setup, reset the system by pressing <Ctrl> + <Alt> + <Delete>, or by pressing the Reset button on the system case. You can also restart by turning the system off and then back on again. But do so only if the first two methods fail.

When you invoke Setup, the CMOS SETUP UTILITY main program screen will appear with the following options:



IV. BIOS SOFTWARE

Load Defaults

Load BIOS Defaults loads the minimum settings for troubleshooting. **Load Setup Defaults**, on the other hand, is for loading optimized defaults for regular use. Choosing defaults at this level will modify all applicable settings.

A section at the bottom of the preceding screen displays the control keys for this screen. Take note of these keys and their respective uses.

Standard CMOS Setup

Standard CMOS Setup allows you to record some basic system hardware configuration and set the system clock and error handling. If the motherboard is already installed in a working system, you will not need to select this option anymore. However, if the configuration stored in the CMOS memory on the board gets lost or damaged, or if you change your system hardware configuration, you will need to respecify the configuration values. The configuration values usually get lost or corrupted when the power of the onboard CMOS battery weakens.



The preceding screen provides you with a list of options. At the bottom of this screen are the control keys. Take note of these keys and their respective uses.

User-configurable fields appear in a different color. If you need information on the selected field, press <F1>. The help menu will then appear to provide you with the information you need. The memory display at the lower right of the screen is read-only and automatically adjusts accordingly.

Details of Standard CMOS Setup

Date

To set the date, highlight the “Date” field and then press either <Page Up>/<Page Down> or <+>/<-> to set the current date. Follow the month, day and year format. Valid values for month, day and year are: **Month: (1 to 12), Day: (1 to 31), Year: (up to 2079)**

IV. BIOS SOFTWARE

Time

To set the time, highlight the “Time” field and then press either <Page Up>/<Page Down> or <+>/<-> to set the current time. Follow the hour, minute and second format. Valid values for hour, minute and second are: **(Hour: (00 to 23), Minute: (00 to 59), Second: (00 to 59)**. If you do not want to modify the current time, press <Enter> three times to go to **HARD DISKS**.

NOTE: You can bypass the date and time prompts by creating an AUTOEXEC.BAT file. For information on how to create this file, refer to the MS-DOS manual.

Hard Disk Drives

This field records the specifications for all non-SCSI hard disk drives installed in your system. The onboard PCI IDE connectors provide Primary and Secondary channels for connecting up to four IDE hard disks or other IDE devices. Each channel can support up to two hard disks; the first of which is the “master” and the second is the “slave”.

Specifications for SCSI hard disks need not to be entered here since they operate using device drivers and are not supported by any the BIOS. If you install either the optional PCI-SC200 or PCI-SC860 SCSI controller card into the motherboard, see section VI for instructions. If you install other vendor’s SCSI controller card, refer to their respective documentations on how to install the required SCSI drivers.

For IDE hard disk drive setup, you can:

- Use the *Auto* setting for detection during bootup.
- Use the IDE HDD AUTO DETECTION in the main menu to automatically enter the drive specifications.
- Enter the specifications yourself manually by using the “User” option.

The entries for specifying the hard disk type include **CYLS** (number of cylinders), **HEAD** (number of read/write heads), **PRECOMP** (write precompensation), **LANDZ** (landing zone), **SECTOR** (number of sectors) and **MODE**. The **SIZE** field automatically adjusts according to the configuration you specify. The documentation that comes with your hard disk should provide you with the information regarding the drive specifications.

The **MODE** entry is for IDE hard disks only, and can be ignored for MFM and ESDI drives. This entry provides three options: *Normal*, *Large*, *LBA*, or *Auto* (see below). Set **MODE** to the *Normal* for IDE hard disk drives smaller than 528MB; set it to *LBA* for drives over 528MB that support Logical Block Addressing (LBA) to allow larger IDE hard disks; set it to *Large* for drives over 528MB that do not support LBA. *Large* type of drive can only be used with MS-DOS and is very uncommon. Most IDE drives over 528MB support the *LBA* mode.

IV. BIOS SOFTWARE

Auto detection of hard disks on bootup

For each field: Primary Master, Primary Slave, Secondary Master, and Secondary Slave, you can select *Auto* under the TYPE and MODE fields. This will enable auto detection of your IDE hard disk during bootup. This will allow you to change your hard disks (with the power off) and then power on without having to reconfigure your hard disk type. If you use older hard disks that do not support this feature, then you must configure the hard disk in the standard method as described earlier by the “User” option.

NOTE: After the IDE hard disk drive information has been entered into BIOS, new IDE hard disk drives must be partitioned (such as with FDISK) and then formatted before data can be read from and write on. Primary IDE hard disk drives must have its partition set to *active* (also possible with FDISK).

NOTE: SETUP Defaults are noted in parenthesis next to each function heading.

Drive A / Drive B (None)

These fields record the types of floppy disk drives installed in your system. The available options for drives A and B are: *360K, 5.25 in.; 1.2M, 5.25 in.; 720K, 3.5 in.; 1.44M, 3.5 in.; 2.88M, 3.5 in.; None*

To enter the configuration value for a particular drive, highlight its corresponding field and then select the drive type using the left- or right-arrow keys.

Floppy 3 Mode Support (Disabled)

This is the Japanese standard floppy drive. The standard stores 1.2MB in a 3.5inch diskette. This is normally disabled but you may choose from either: *Drive A, Drive B, Both, and Disabled*

Video (EGA/VGA)

Set this field to the type of video display card installed in your system. The options are *EGA/VGA, CGA 40, CGA 80, and MONO* (for Hercules or MDA).

If you are using a VGA or any higher resolution card, choose *EGA/VGA*.

Halt On (All Errors)

This field determines which types of errors will cause the system to halt. Choose from *All Errors; No Errors; All,But Keyboard; All,But Diskette; and All,But Disk/Key*.

IV. BIOS SOFTWARE

BIOS Features Setup

BIOS Features Setup consists of configuration entries that allow you to improve your system performance, or let you set up some system features according to your preference. Some entries are required by the motherboard's design to remain in their default settings.



A section at the lower right of the screen displays the control keys you can use. Take note of these keys and their respective uses. If you need information on a particular entry, highlight it and then press <F1>. A pop-up help menu will appear to provide you with the information you need. <F5> loads the last set values, <F6> and <F7> loads the BIOS default values and Setup default values, respectively.

NOTE: SETUP Defaults are noted in parenthesis next to each function heading.

Details of BIOS Features Setup

Boot Virus Detection (Enabled)

This field allows you to set boot virus detection, ensuring a virus-free boot sector. This new antivirus solution is unlike native BIOS tools, which offer limited virus protection typically by write-protecting the partition table. With this new solution, your computer is protected against boot virus threats earlier in the boot cycle, that is, before they have a chance to load into your system. This ensures your computer boots to a clean operating system. The system halts and displays a warning message when it detects a virus. If this occurs, you can either allow the operation to continue or use a virus-free bootable floppy disk to restart and investigate your system. Because of conflicts with new operating systems, for example, during installation of new software, you may have to set this to *Disabled* to prevent write errors.

CPU Internal Cache (Enabled)

Choose *Disable* to turn off the CPU's built-in level 1 cache.

External Cache (Enabled)

Choose *Disable* to turn off the CPU's external level 2 cache.

IV. BIOS SOFTWARE

Quick Power On Self Test (Enabled)

This field speeds up the Power-On Self Test (POST) routine by skipping retesting a second, third, and fourth time. Setup default setting for this field is *Enabled*. A complete test of the system is done on each test.

HDD Sequence SCSI/IDE First (IDE)

When using both SCSI and IDE hard disk drives, IDE is always the boot disk using drive letter C (default setting of *IDE*). This new feature allows a SCSI hard disk drive to be the boot disk when set to *SCSI*. This allows multiple operating systems to be used on both IDE and SCSI drives or the primary operating system to boot using a SCSI hard disk drive.

Boot Sequence (A,C)

This field determines where the system looks first for an operating system. Options are *A,C*; *A,CDROM,C*; *CDROM,C,A*; *CDROM A,C*; *D,A*; *E,A*; *F,A*; *C only*; *LS/ZIP,C*; *LAN,A,C*; *LAN,C,A*; and *C,A*. The setup default setting, *A,C*, checks first the floppy disk and then the hard disk drive.

Boot Up Floppy Seek (Disabled)

When enabled, the BIOS will seek drive A one time.

Floppy Disk Access Control (R/W)

This allows protection of files from the computer system to be copied to floppy disk drives by allowing the setting of *Read Only* to only allow reads from the floppy disk drive but not writes. The setup default *R/W* allows both reads and writes.

IDE HDD Block Mode Sectors (HDD MAX)

This field enhances hard disk performance by making multi-sector transfers instead of one sector per transfer. Most IDE drives, except older versions, can utilize this feature. Selections are *HDD MAX*, *Disabled*, *2*, *4*, *8*, *16*, and *32*.

HDD S.M.A.R.T. capability (Disabled)

This field enables or disables S.M.A.R.T. (Self-Monitoring Analysis and Reporting Technology) support for S.M.A.R.T.-capable hard disk drives. This technology requires an application that can display S.M.A.R.T. warning messages.

PS/2 Mouse Function Control (Auto)

The setting of *Auto* allows the system to detect a PS/2 Mouse on bootup. If detected, IRQ12 will be used for the PS/2 Mouse. If not detected, IRQ12 will be reserved for expansion cards. *Enabled* will reserve IRQ12 for the PS/2 Mouse.

OS/2 Onboard Memory > 64M (Disabled)

When using OS/2 operating systems with installed DRAM of greater than 64MB, you need to *Enable* this option otherwise leave this on the setup default of *Disabled*.

.....

PCI/VGA Palette Snoop (Disabled)

Some display cards that are nonstandard VGA, such as graphic accelerators or MPEG video cards may not show colors properly. Setting this to *Enabled* should correct this problem. Otherwise, leave this on the default setting of *Disabled*.

Video ROM BIOS Shadow (Enabled)

This field allows you to change the video BIOS location from ROM to RAM. Relocating to RAM enhances system performance, as information access is faster than the ROM.

IV. BIOS SOFTWARE

C8000 - CBFFF Shadow to DC000 - DFFFF Shadow (Disabled)

These fields are used for shadowing other expansion card ROMs. If you install other expansion cards with ROMs on them, you will need to know which addresses the ROMs use to shadow them specifically. Shadowing a ROM reduces the memory available between 640KB and 1024KB by the amount used for this purpose.

Boot Up NumLock Status (On)

This field enables users to activate the Number Lock function upon system boot.

Typematic Rate Setting (Disabled)

When enabled, you can set the **Typematic Rate** and **Delay**.

Typematic Rate (Chars/Sec) (6)

This field controls the speed at which the system registers repeated keystrokes. Options range from 6 to 30 characters per second. Setup default setting is **6**; other settings are **8, 10, 12, 15, 20, 24, and 30**.

Typematic Delay (Msec) (250)

This field sets the time interval for displaying the first and second characters. Four delay rate options are available: 250, 500, 750, and 1000.

Security Option (System)

When you specify a *Supervisor Password* and/or *User Password* (explained later in this section), the Security Option field determines when the system prompts for the password. The default setting is **System**, where the system prompts for the User Password every time you start your system. The other option is **Setup**, where the system goes through its startup routine unless the Setup utility is called, when the system prompts for the Supervisor Password.

Chipset Features Setup

Chipset Features Setup controls the configuration of the board's chipset. Control keys for this screen are the same as in the **BIOS Features Setup** screen.



NOTE: SETUP Defaults are noted in parenthesis next to each function heading.

IV. BIOS SOFTWARE

Details of Chipset Features Setup

SDRAM Configuration (By SPD)

This sets the optimal timing for items 2-4. Leave on default setting, depending on the memory modules that you are using. Default setting is *By SPD*, which configures items 2-4 by reading the contents in the SPD (Serial Presence Detect) device. This 8-pin serial EEPROM device stores critical parameter information about the module, such as memory type, size, speed, voltage interface, and module banks.

SDRAM CAS Latency

This controls the latency between SDRAM read command and the time that the data actually becomes available. Leave on default setting.

SDRAM RAS to CAS Delay

This controls the latency between SDRAM active command and the read/write command. Leave on default setting.

SDRAM RAS Precharge Time

This controls the idle clocks after issuing a precharge command to SDRAM. Leave on default setting.

Enhanced Page Mode Count (Disabled) / Internal Page Detection (Disabled)

Leave both on default setting.

SDRAM Pipe Function (Disabled) / SDRAM x111-2111 Mode (Enabled)

Leave both on default setting.

I/O Recovery Time (2 BUSCLK)

Timing for ISA cards. Leave on default setting.

Graphics Aperture Size (64MB)

Memory-mapped, graphics data structures can reside in a Graphics Aperture. Leave on default setting.

Frame Buffer Posted Write (Enabled)

Enabling (default) this feature will increase the efficiency of the CPU-to-VGA frame buffer cycle. Leave on default setting.

Force PCI_66 GAT Mode (Enabled)

Enabling this feature will flush the internal PCI/66 buffer before data transfer. Setting this to *Disabled* may cause some AGP card compatibility problems.

AGP Bus Turbo Mode (Enabled)

Enabling (default) this feature will improve AGP Bus performance. Disable this for AGP compatibility. Leave on default setting.

Passive Release (Enabled)

This is a mechanism that allows concurrency of CPU-to-ISA cycles. When this feature is enabled, it will be possible to re-arbitrate the PCI bus and allow the CPU to access PCI even when the M1543C has been granted the ISA bus.

Delayed Transaction (Disabled)

If *Enabled*, this frees the PCI Bus during CPU accessing of 8-bit ISA cards that normally consume about 50-60 PCI Clocks without PCI delayed transaction. If PCI Bus Masters cannot use the PCI Bus, leave this on the default setting of *Disabled* for some ISA cards that are not PCI 2.1 compliant.

IV. BIOS SOFTWARE

Memory Hole At 15M-16M (Disabled)

Enabling this feature reserves 15MB-16MB memory address space to ISA expansion cards that specifically require this setting. This makes the memory from 15MB and up unavailable to the system. Expansion cards can only access memory up to 16MB. The default is *Disabled*.

Data Integrity Mode (Disabled)

Data Integrity Mode or ECC is always *Disabled* when bus speeds $\geq 83\text{MHz}$ or when bus speed is equal to 75MHz and PCI clock is equal to the bus clock/2. When this field is *Disabled*, byte-wise write capability is available but no provision for protecting data integrity in the memory module array is available; although data errors are detected, they are not corrected. When *Enabled*, ECC is available, allowing a detection of single-bit and multiple-bit errors and recovery of single-bit errors. [See **2. System Memory (DIMM)**, section III for more information on memory modules.]

KBD Clock Source Speed (8MHz)

This field allows you to set the internal keyboard clock line speed. Set to either *12MHz* or *16MHz* if the default setting of *8MHz* does not work with your operating system.

.....

Onboard FDC Controller (Enabled)

When enabled, this field allows you to connect your floppy disk drives to the onboard floppy drive connector instead of a separate controller card. If you want to use a different controller card to connect the floppy disk drives, set this field to *Disabled*.

Onboard FDC Swap A & B (No Swap)

This field allows you to reverse the hardware drive letter assignments of your floppy disk drives. Two options are available: *Swap AB* and *No Swap* (default). If you want to switch drive letter assignments, set this field to *Swap AB*, and the swap will be controlled by the onboard chipset.

Onboard Serial Port 1 (3F8H/IRQ4)

Settings are *3F8H/IRQ4*, *2F8H/IRQ3*, *3E8H/IRQ4*, *2E8H/IRQ10*, and *Disabled* for the onboard serial connector.

Onboard Serial Port 2 (2F8H/IRQ3)

Settings are *3F8H/IRQ4*, *2F8H/IRQ3*, *3E8H/IRQ4*, *2E8H/IRQ10*, and *Disabled* for the onboard serial connector.

Onboard Parallel Port (378H/IRQ7)

This field sets the address of the onboard parallel port connector. You can select either *3BCH/IRQ 7*, *378H/IRQ 7*, *278H/IRQ 5*, or *Disabled*. If you install an I/O card with a parallel port, ensure that there is no conflict in the address assignments. The PC can support up to three parallel ports as long as there are no conflicts for each port.

IV. BIOS SOFTWARE

Parallel Port Mode (ECP+EPP)

This field allows you to set the operation mode of the parallel port. The setting *Normal*, allows normal-speed operation but in one direction only; *EPP* allows bidirectional parallel port operation at maximum speed; *ECP* allows the parallel port to operate in bidirectional mode and at a speed faster than the maximum data transfer rate; *ECP+EPP* allows normal speed operation in a two-way mode.

ECP DMA Select (3)

This selection is available only if you select *ECP* or *ECP+EPP* in the **Parallel Port Mode**. Select either DMA Channel *1*, *3*, or *Disabled*.

Onboard IR (Disabled)

When enabled, this field activates the onboard infrared feature and sets the second serial UART to support the infrared module connector on the motherboard. If your system already has a second serial port connected to the onboard COM2 connector, it will no longer work if you enable the infrared feature. By default, this field is set to *Disabled*, which leaves the second serial port UART to support the COM2 serial port connector.

IR Mode (IrDA SIR)

This motherboard supports IrDA compatible Serial Infrared (SIR) and Fast Infrared (FIR) communication modes. The FIR mode has two options: *FIR/HP* and *FIR/IBM*, for computers or peripherals using HP and IBM's infrared transceivers, respectively. When using either FIR option, **FIR DMA Select** must be configured to reflect the DMA channel used by the port.

FIR DMA Select (1)

This allows you to configure the DMA channel used by the FIR port. Options are DMA *1* (default) or DMA *3*.

Onboard PCI IDE Enable (Both)

You can select to enable the *Primary* IDE channel, *Secondary* IDE channel, *Both*, or *Disable* both channels (for systems with only SCSI drives).

IDE Ultra DMA Mode (Auto)

This sets the IDE UltraDMA to be active when using UltraDMA-capable IDE devices. The BIOS will automatically adjust or disable this setting for slower IDE devices so that Auto or high settings will not cause problems for older IDE devices. Choose *Disable* if you do not want this feature for all devices.

IDE 0 Master/Slave PIO/DMA Mode, IDE 1 Master/Slave PIO/DMA Mode (Auto)

Each channel (0 and 1) has both a master and a slave making four IDE devices possible. Because each IDE device may have a different Mode timing (0, 1, 2, 3, 4), it is necessary for these to be independent. PIO and DMA timings can be independently set. The default setting of *Auto* will allow autodetection to ensure optimal performance.

IV. BIOS SOFTWARE

Power Management Setup

Power Management Setup allows you to reduce power consumption. This feature turns off the video display and shuts down the hard disk after a period of inactivity.



NOTE: SETUP Defaults are noted in parenthesis next to each function heading.

Details of Power Management Setup

Power Management (User Define)

This field acts as the master control for the power management modes. *User Define* allows you to set power saving options according to your preference; *Disable* disables the power saving features; *Min Saving* puts the system into power saving mode after 40 min of system inactivity; *Max Saving* puts the system into power saving mode after 30 sec of system inactivity.

IMPORTANT: Advanced Power Management (APM) should be installed to keep the system time updated when the computer enters suspend mode activated by the BIOS Power Management. For DOS environments, you need to add `DEVICE=C:\DOS\POWER.EXE` in your `CONFIG.SYS`. For Windows 3.x and Windows 95, you need to install Windows with the APM feature. A battery and power cord icon labeled “Power” will appear in the “Control Panel.” Choose “Advanced” in the Power Management Field.

Video Off Option (Susp,Stby -> Off)

This field determines when to activate the video off feature for monitor power management. The settings are *All Modes -> Off*; *Always On*; *Suspend -> Off*; and *Susp,Stby -> Off*.

IV. BIOS SOFTWARE

Video Off Method (DPMS OFF)

This field defines the video off features. These options are available: *DPMS OFF*, *DPMS Reduce ON*, *Blank Screen*, *V/H SYNC+Blank*, *DPMS Standby*, and *DPMS Suspend*. The DPMS (Display Power Management System) features allow the BIOS to control the video display card if it supports the DPMS feature. *Blank Screen* only blanks the screen (for monitors without power management or “green” features). If set up in your system, your screen saver will not display with *Blank Screen* selected). *V/H SYNC+Blank* blanks the screen and turns off vertical and horizontal scanning.

.....

PM Timers

This section controls the time-out settings for the Power Management scheme. The fields included in this section are **HDD Power Down**, which places the hard disk into its lowest power consumption mode, and the **Doze**, **Standby** and **Suspend** system inactivation modes.

The system automatically “wakes up” from any power saving mode when there is system activity, such as when a key is pressed from the keyboard, or when there is activity detected from the enabled IRQ channels.

HDD Power Down (Disable)

This shuts down any IDE hard disk drives in the system after a period of inactivity. This time period is user-configurable from *1 Min* to *15 Min* or *Disable*. This feature does not affect SCSI hard disks.

Doze Mode, Standby Mode, Suspend Mode (Disable)

These fields set the period of time after which each of these modes activate: *1 Min*, *2 Min*, *3 Min*, *4 Min*, *8 Min*, *20 Min*, *30 Min*, *40 Min*, or *1 Hour*. The default setting is *Disable*.

.....

Power Up Control

This section determines the ways the system can be controlled when it is started or restarted, when modem activity is detected, or when power to the computer is interrupted and reapplied. The Soft-Off mode refers to powering off the system through a momentary button switch (ATX switch) or through the software as opposed to disconnecting the AC power by way of a rocker switch or other means.

PWR Button < 4 Secs (Soft Off)

When set to *Soft Off*, the ATX switch can be used as a normal system power-off button when pressed for less than 4 seconds. *Suspend* allows the button to have a dual function where pressing less than 4 seconds will place the system in sleep mode. Regardless of the setting, holding the ATX switch for more than 4 seconds will power off the system.

PWR Up On Modem Act (Enabled)

This allows either settings of *Enabled* or *Disabled* for powering up the computer (turns the ATX power supply on) when the modem receives a call while the computer is off. **NOTE:** The computer cannot receive or transmit data until the computer and applications are fully running, thus connection cannot be made on the first try. Turning an external modem off and then back on while the computer is off causes an initialization string that will also cause the system to power on.

IV. BIOS SOFTWARE

Wake On LAN (Enabled)

This allows you to remotely power up your system through your network by sending a wake-up frame or signal. With this feature, you can remotely upload/download data to/from systems during off-peak hours. Set to *Enabled* to use this feature.

IMPORTANT: This feature requires the ASUS PCI-L101 LAN Card (see **VI. ASUS LAN Card**) and an ATX power supply with at least 720mA +5V standby power.

Automatic Power Up (Disabled)

This allows you to have an unattended or automatic power up of your system. You may configure your system to power up at a certain time of the day by selecting *Everyday*, which will allow you to set the time or at a certain time and day by selecting *By Date*.

.....

Fan Monitor (xxxxRPM)

The onboard hardware monitor is able to detect the Chassis Fan Speed, CPU Fan Speed, and the Power Supply Fan Speed in Rotations Per Minute (RPM). These values refresh upon any key entries in the BIOS setup screen. Set to *Ignore* if one of these are not used so that error messages will not be given.

Thermal Monitor (xxxC/xxxF)

The onboard hardware monitor is able to detect the CPU and MB (motherboard) temperatures. These values refresh upon key entries. Set to *Ignore* only if necessary.

Voltage Monitor (xx.xV)

The onboard hardware monitor is able to detect the voltages put out by the voltage regulators. These values refresh upon key entries. Set to *Ignore* only if necessary.

NOTE: If any of the monitored items are out of range, an error message will appear: "Hardware Monitor found an error, enter POWER MANAGEMENT SETUP for details". You will then be prompted to "Press **F1** to continue, **DEL** to enter SETUP".

IV. BIOS SOFTWARE

PNP and PCI Setup

This “PNP and PCI Setup” option configures the PCI bus slots. All PCI bus slots on the system use INTA#, thus all installed PCI cards must be set to this value.

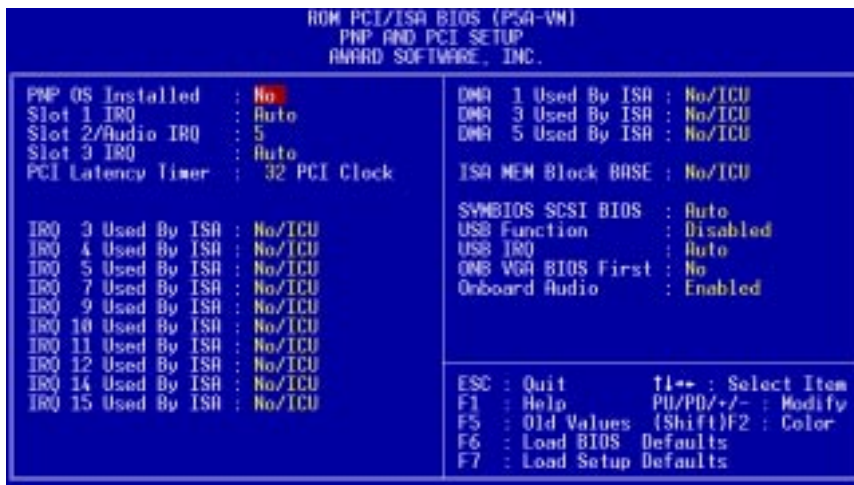

NOTE: SETUP Defaults are noted in parenthesis next to each function heading.

Details of PNP and PCI Setup

PNP OS Installed (No)

This field allows you to use a Plug-and-Play (PnP) operating system to configure the PCI bus slots instead of using the BIOS. Thus interrupts may be reassigned by the OS when *Yes* is selected. When a non-PnP OS is installed or to prevent reassigning of interrupt settings, select the default setting of *No*.

Slot 1 IRQ (Auto) / Slot 2/Audio IRQ (5) / Slot 3 IRQ (Auto)

These fields set how IRQ use is determined for each PCI slot. The default setting for each field is *Auto*, which uses auto-routing to determine IRQ use. The other options are manual settings of *NA*, *5*, *7*, *9*, *10*, *11*, *12*, *14* or *15* for each slot.

PCI Latency Timer (32 PCI Clock)

The default setting of *32 PCI Clock* enables maximum PCI performance.

IRQ xx Used By ISA (No/ICU)

These fields indicate whether or not the displayed IRQ for each field is being used by a legacy (non-PnP) ISA card. Two options are available: *No/ICU* and *Yes*. The first option, the default value, indicates either that the displayed IRQ is not used or an ISA Configuration Utility (ICU) is being used to determine if an ISA card is using that IRQ. If you install a legacy ISA card that requires a unique IRQ, and you are not using an ICU, you must set the field for that IRQ to *Yes*. For example: If you install a legacy ISA card that requires IRQ 10, then set **IRQ10 Used By ISA** to *Yes*.

.....

IV. BIOS SOFTWARE

DMA x Used By ISA (No/ICU)

These fields indicate whether or not the displayed DMA channel for each field is being used by a legacy (non-PnP) ISA card. Available options include: *No/ICU* and *Yes*. The first option, the default setting, indicates either that the displayed DMA channel is not used or an ICU is being used to determine if an ISA card is using that channel. If you install a legacy ISA card that requires a unique DMA channel, and you are not using an ICU, you must set the field for that channel to *Yes*.

ISA MEM Block BASE (No/ICU)

This field allows you to set the base address and block size of a legacy ISA card that uses any memory segment within the C800H and DFFFH address range. If you have such a card, and you are not using an ICU to specify its address range, select a base address from the six available options; the **ISA MEM Block SIZE** field will then appear for selecting the block size. If you have more than one legacy ISA card in your system that requires to use this address range, you can increase the block size to either 8K, 16K, 32K, or 64K. If you are using an ICU to accomplish this task, leave **ISA MEM Block BASE** to its default setting of *No/ICU*.

SYMBIOS SCSI BIOS (Auto)

Auto allows the motherboard's BIOS to detect whether you have a Symbios SCSI card. If a Symbios SCSI card is detected, the motherboard's Symbios BIOS will be enabled; if no Symbios SCSI card is detected, the onboard Symbios SCSI BIOS will be disabled. *Disabled* will disable the motherboard's Symbios SCSI BIOS so that the BIOS on an external Symbios SCSI card can be used. (If your Symbios SCSI card does not have a BIOS, the Symbios SCSI card will not function.)

USB Function (Disabled)

This motherboard supports Universal Serial Bus (USB) devices. Set to *Enabled* if you want to use USB devices. Your system must support USB function. The default setting is *Disabled*.

USB IRQ (Auto)

This field allows you to reserve an IRQ# (5, 7, 9, 10, 11, 12, 14, or 15) for the USB to work. *Auto* assigns an IRQ# automatically to your USB device. If you are not using a USB device, you may disable this feature by setting it to *NA* to save an extra IRQ# for other devices or expansion cards.

ONB VGA BIOS First (No)

This field, when set to *Yes*, gives priority to the onboard VGA BIOS over other VGA controllers. The default setting is *No*.

Onboard Audio (Enabled)

This field allows you to enable the onboard audio. If you do not want to use the onboard audio, select *Disabled*. (This feature is available only on motherboards with the audio option.)

IV. BIOS SOFTWARE

Load BIOS Defaults

This “Load BIOS Defaults” option allows you to load the troubleshooting default values permanently stored in the BIOS ROM. These default settings are non-optimal and disable all high performance features. To load these default settings, highlight “Load BIOS Defaults” on the main screen and then press <Enter>. The system displays a confirmation message on the screen. Press <Y> and then <Enter> to confirm. Press <N> and then <Enter> to abort. This feature does not affect the fields on the Standard CMOS Setup screen.

Load Setup Defaults

This “Load Setup Defaults” option allows you to load the default values to the system configuration fields. These default values are the optimized configuration settings for the system. To load these default values, highlight “Load Setup Defaults” on the main screen and then press <Enter>. The system displays a confirmation message on the screen. Press <Y> and then <Enter> to confirm. Press <N> and then <Enter> to abort. This feature does not affect the fields on the Standard CMOS Setup screen.

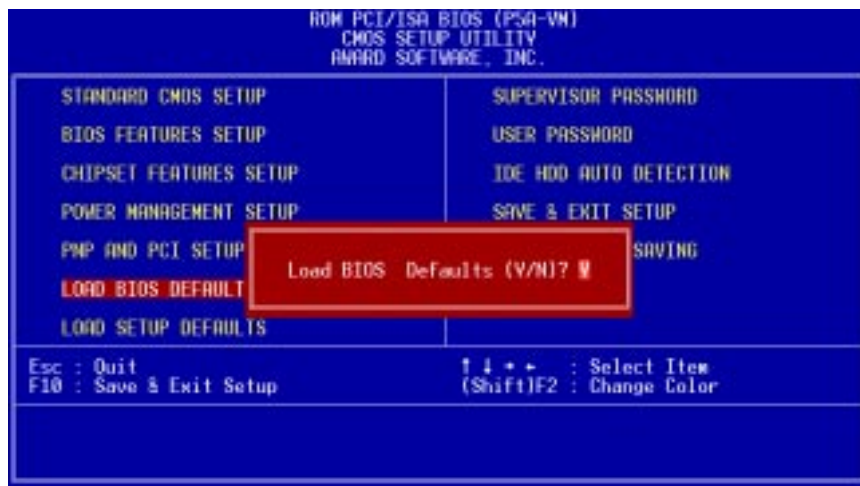

IV. BIOS SOFTWARE

Supervisor Password and User Password

These two options set the system passwords. “Supervisor Password” sets a password that will be used to protect the system and the Setup utility; “User Password” sets a password that will be used exclusively on the system. By default, the system comes without any passwords. To specify a password, highlight the type you want and then press <Enter>. A password prompt appears on the screen. Taking note that the password is case sensitive, and can be up to 8 alphanumeric characters long, type in your password and then press <Enter>. The system confirms your password by asking you to type it again. After setting a password, the screen automatically reverts to the main screen.



To implement password protection, specify in the “Security Option” field of the BIOS Features Setup screen when the system will prompt for the password. If you want to disable either password, press <Enter> instead of entering a new password when the “Enter Password” prompt appears. A message confirms the password has been disabled.

NOTE: If you forget the password, see CMOS RAM in section III for procedures on clearing the CMOS.

IV. BIOS SOFTWARE

IDE HDD Auto Detection

This “IDE HDD Auto Detection” option detects the parameters of an IDE hard disk drive, and automatically enters them into the Standard CMOS Setup screen.

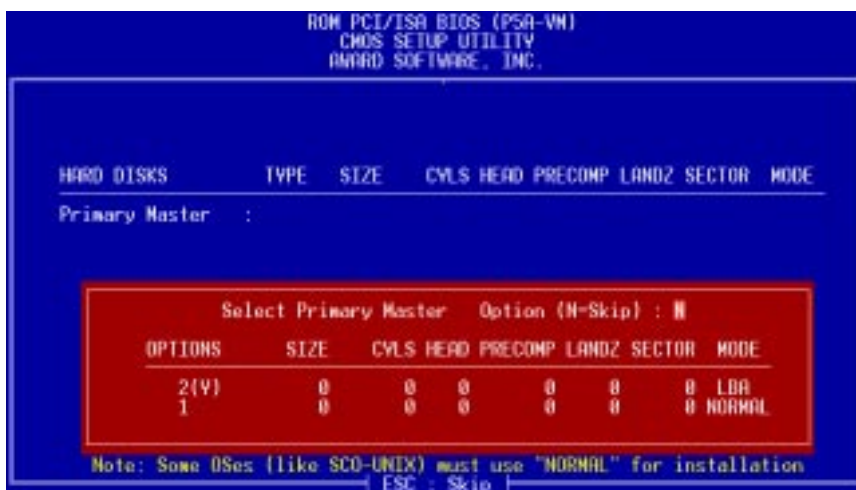

Up to four IDE drives can be detected, with parameters for each listed inside the box. To accept the optimal entries, press <Y> or else select from the numbers displayed under the OPTIONS field (2, 1, 3 in this case); to skip to the next drive, press <N>. If you accept the values, the parameters will appear listed beside the drive letter on the screen. The process then proceeds to the next drive letter. Pressing <N> to skip rather than to accept a set of parameters causes the program to enter zeros after that drive letter.

Remember that if you are using another IDE controller that does not feature Enhanced IDE support for four devices, you can only install two IDE hard disk drives. Your IDE controller must support the Enhanced IDE features in order to use Drive E and Drive F. The onboard PCI IDE controller supports Enhanced IDE, with two connectors for connecting up to four IDE devices. If you want to use another controller that supports four drives, you must disable the onboard IDE controller in the Chipset Features Setup screen.

When auto-detection is completed, the program automatically enters all entries you accepted on the field for that drive in the Standard CMOS Setup screen. Skipped entries are ignored and are not entered in the screen.

If you are auto-detecting a hard disk that supports the LBA mode, three lines will appear in the parameter box. Choose the line that lists LBA for an LBA drive. Do not select Large or Normal.

The auto-detection feature can only detect one set of parameters for a particular IDE hard drive. Some IDE drives can use more than one set. This is not a problem if the drive is new and empty.

IV. BIOS SOFTWARE

IMPORTANT: If your hard disk was already formatted on an older previous system, incorrect parameters may be detected. You will need to enter the correct parameters manually or use low-level format if you do not need the data stored on the hard disk.

If the parameters listed differ from the ones used when the disk was formatted, the disk will not be readable. If the auto-detected parameters do not match the ones that should be used for your disk, do not accept them. Press <N> to reject the presented settings and enter the correct ones manually from the Standard CMOS Setup screen.

Save & Exit Setup

Select this option to save into the CMOS memory all modifications you specified during the current session. To save the configuration changes, highlight the “Save & Exit Setup” option on the main screen, type “Y”, and then press <Enter>.

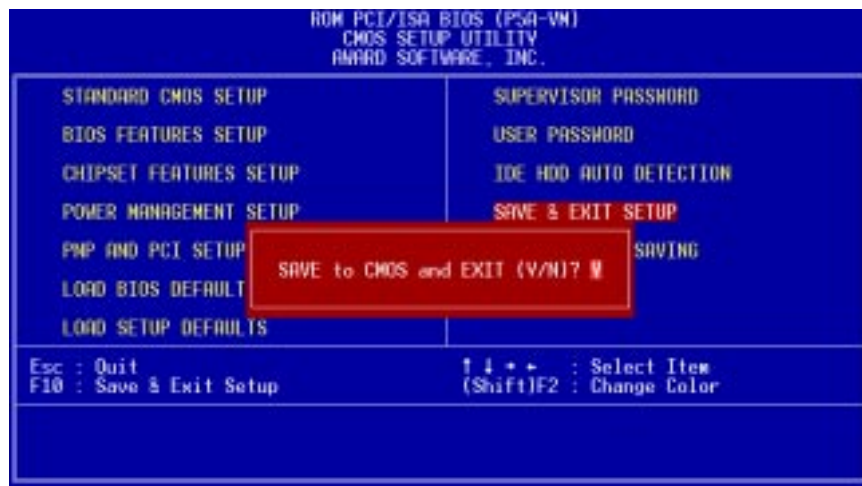

Exit Without Saving

Select this option to exit the Setup utility without saving the modifications you specify during the current session. To exit without saving, highlight the “Exit Without Saving” option on the main screen and then press <Enter>.

V. SUPPORT SOFTWARE

ASUS Smart Motherboard Support CD

(Included only with motherboards with onboard hardware monitoring)

NOTE: The support CD contents are subject to change at any time without notice.

To begin using your support CD disc, just insert it into your CD-ROM drive and the support CD installation menu should appear. If the menu does not appear, double click or run **D:\SETUP.EXE** (assuming that your CD-ROM drive is drive **D:**).

- **LDCM Local Setup:** Installs the LANdesk Client Manager (LDCM) software to monitor the local system. A user's manual in Adobe Acrobat PDF format is available under the **LDCM33/Local** folder.
- **LDCM Administrator Setup:** Installs the LDCM software to monitor PC systems on the network within the same bridge address with the Local software installed. A user's manual in PDF format is available under the **LDCM33/Admin** folder.
- **ASUS PC Probe Setup:** Installs a simple utility to monitor your computer's fan, temperature, and voltages. (**NOTE:** This utility will not run with LDCM installed.) A user's manual in PDF format is available under the **ASUSLM** folder created on your system during setup.
- **Adobe Acrobat Reader:** Installs the Adobe Acrobat Reader software necessary to view user's manuals saved in PDF format, such as that of the ASUS PC Probe. Updated or other language versions of this motherboard's manual is available in PDF format at any of our web sites.
- **Install VGA Driver and Utility:** Installs the necessary VGAdrivers and utilities to access the features of the built-in VGA chipset.
- **Install ALi Bus Master Driver:** Installs the ALi BusMaster IDE driver for improved performance.
- **Install ALi AGP Mini Port Driver:** Installs the ALi Mini Port Driver for Windows 95/98.
- **Install ALi M7101 Patch:** Installs the ALi M7101 patch for Windows 95.
- **Install ESS Audio Driver (Optional):** Displays instructions on installing the audio drivers for Windows 95/98.
- **Install ESS Software Wavetable (Optional):** Installs the ESS software wavetable for Windows 95.
- **Install Audio Rack (Optional):** Installs the ESS Audio Rack utilities. Refer to the audio manual (separate) for more information.
- **Install 3 Mode Floppy Driver:** Installs the 3 Mode Floppy Driver (Japanese version only) for DOS and Windows 95/98/NT
- **Install PCCillin:** Installs the PC-cillin virus protection software. View the online help for more information.
- **LDCM Introduce (MPEG VCD):** Plays an overview of LDCM in MPEG format.
- **Browse this CD:** Allows you to view the contents of the CD.
- **Read Me:** Displays the filelist for the included support software.
- **Exit:** Exits the CD installation menu.

Additional CD Contents: DMI Configuration Utility under the **DMI** folder, Flash BIOS writer under the **AFLASH** folder, ALi Fast Infrared Driver for Windows 98 under the **FIR** folder.

V. Support CD

A. Video Driver	61
First Time Installation	61
Operating Systems	61
Install Video Driver and Utility (Windows 95/98)	62
Display Settings for Windows 95/98	63
Adjustment Menu	63
Panning Menu	63
Color	64
Settings	64
B. Other Video Drivers	65
Video Driver Installation for Windows NT 4.0	65
Installing Video Drivers for Windows NT 4.0	65
Video Driver Installation for IBM OS/2	66
Select System Information (optional)	68
Quick Setup (optional)	68
VDIF Files (optional)	69
Advanced Setup (optional)	70
Diagnostics	70
Troubleshooting	71
System Lockup	71
Troubleshooting	71
Windows 95 mach64 enhanced display driver	73
Windows 95 property page problems	73
ATI Video Player Notes	73
Other Problems & Actions	74
C. ATI Player	75
ATI Player	75
Features	75
Playing Audio CDs (Only in window 95)	76
Playing Media Files	77
Playing Interactive Discs (Video CD 2.0)	77
D. Audio Driver	79
First Time Installation	79
For Windows 95	79
For Windows 98	79
First Time Installation	80
For Windows NT 4.0	81

V. Support CD

E. Audio Software	83
Audio Rack Installation	83
Audio Rack Introduction	83
The Command Center	84
Introduction	84
The Command Center Controls	84
The Command Center Display	84
The Miniature Mode	85
Introduction	85
The Miniature Mode Controls	85
The Audio Mixer	86
Introduction	86
The Audio Mixer Controls	86
The Digital Audio Player	87
Introduction	87
The Digital Audio Player Controls	87
The Digital Audio Player Display	87
The MIDI Player	88
Introduction	88
The MIDI Player Controls	88
The MIDI Player Display	88
The Compact Disk Player	89
Introduction	89
The Compact Disk Player Controls	89
The Audio Recorder	90
Introduction	90
The Audio Recorder Controls	90
The Audio Recorder Display	90
Release Notes	91
Disable Eject Button on the CD Player	91
Using AudioRack CD Player as Default CD Player	91
Configuring Playback Mixer	91
F. Software Wavetable	92
Install Software Wavetable (Windows 95/98)	92
G. DMI Utility	93
Desktop Management Interface (DMI)	93
Introducing the ASUS DMI Configuration Utility	93
System Requirements	93
Using the ASUS DMI Configuration Utility	94

A. Video Driver

First Time Installation

When you start Windows for the first time after the installation of your motherboard, Windows 95/98 will detect the onboard video chip (either ATI 3D Rage Pro AGP 2X or ATI 3D Rage IIC AGP, depending on your motherboard) and may attempt to install a driver from its system registry. When prompted to restart, select **No**. Then follow the normal installation procedure later in this section.

IMPORTANT: Selecting **No** for the initial restart prompt is a necessary step because Windows may load an older display driver that is incompatible with the onboard ATI 3D Rage chip. Always use the driver available on the ASUS Support CD or an applicable driver update from your ASUS vendor or from the ASUS web site.

Operating Systems

You should always use the latest operating system and updates when using new hardware in order to ensure full compliancy. For Windows 95, you must use OSR 2.0 or later. For Windows NT 4.0, you must use Service Pack 3.0 or later.

A. Video Driver

Install Video Driver and Utility (Windows 95/98)

Install Video Driver and Utility installs the video driver necessary for your card to have higher performance, resolutions, and special features. You can also install the ATI Player—a software multimedia player which provides full-screen MPEG video playback with excellent color quality, plus a host of advanced multimedia features.

To install the video driver and utility for Windows 95/98

Insert the Support CD that came with your motherboard into your CD-ROM drive or double-click the CD drive icon in **My Computer** to bring up the autorun screen or run **Setup.exe** in the root directory of your CD-ROM drive.

Click **Install Video Driver and Utility**.

The *ATI Installation* dialog box will appear.

Click **Easy Install** to begin the Installation Wizard.

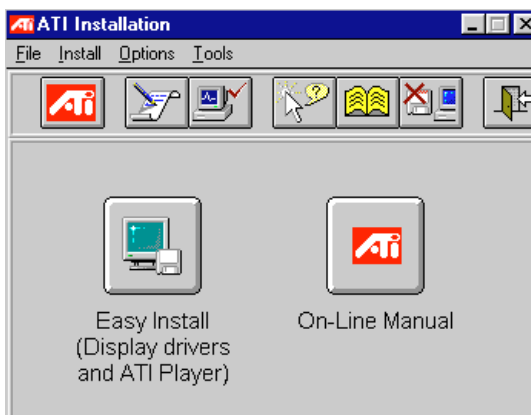

The *ATI Setup* screen will appear.

Click **Next** to proceed with the installation and follow the onscreen instructions to complete the installation.

When prompted to restart your computer, click **Yes**.



A. Video Driver

Display Settings for Windows 95/98

To change resolution, color, and other display properties, either right-click the Windows 95/98 desktop and then choose **Properties**, double-click the **Display** icon in the Control Panel, or right-click the ATI icon in the system tray.

Adjustment Menu

You can adjust the screen output on the monitor from the Adjustment menu. Use the Position and Size arrows to center your screen and make it as large as possible.

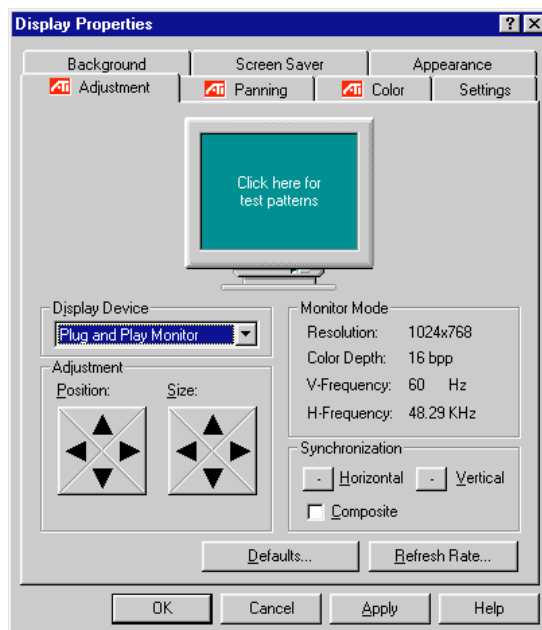

Panning Menu

This allows you to assign hotkeys in the *Value* box for moving your screen up, down, left, right, in, or out in any application. Click **Defaults** to fill in the *Value* box with default values.

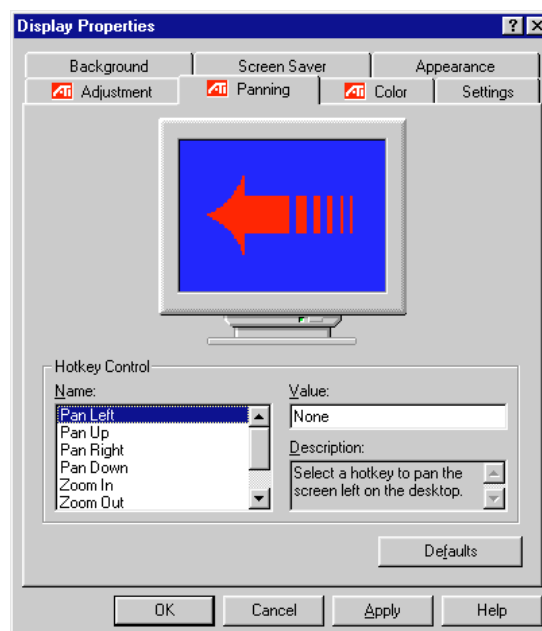

A. Video Driver

Color

This allows you to adjust the Gamma level for your monitor and color levels for Red, Green, and Blue. You can save your settings by clicking **Save As** and typing in a file name. This allows you to recall previously saved settings. Click **Defaults** to restore all settings to their defaults.

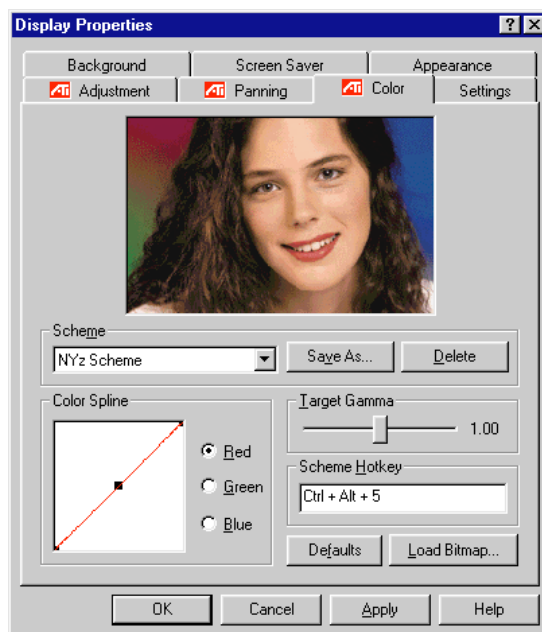

Settings

This allows you to adjust the Color palette, Font size, and Display area. Choose **Center dialog boxes** to keep messages visible, **Enable task bar icon** for easy access to the ATI configuration menus, and **Show settings icon on task bar** for quick resolution changes.

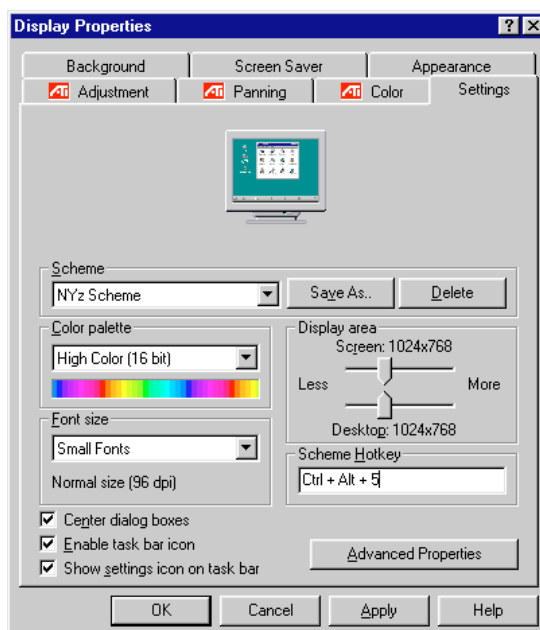

B. Other Video Drivers

Video Driver Installation for Windows NT 4.0

IMPORTANT!

- Windows NT 3.5x does not support AGP cards.
- Before installing the ASUS display driver in Windows NT 4.0, make sure that you have installed the **Windows NT 4.0 Service Pack version 3.0** (available on the Internet at http://www.microsoft.com/isapi/support/bldqpage.idc?ProductPage=q_servpk). Otherwise, the system will hang and will not be able to start up!
- For all the AGP features to be available you must be using Windows NT 5.0 (available in the future)

Installing Video Drivers for Windows NT 4.0

Windows NT will default to standard VGA mode (640x480, 16 colors) when you first start it. Follow the procedure below to install the video driver and player for Windows NT 4.0.

To install the video driver and player for Windows NT 4.0

1. Insert the ASUS Support CD into your CD-ROM drive.
If Windows NT autoruns the CD, skip to step 5.
2. Click **Start**.
3. Select **Run**.
4. Type **D:\ATI\ATISSETUP** (where D is your CD-ROM drive).
5. Click **Easy Install** to begin the Installation Wizard.
6. Follow the Wizard's on-screen instructions to complete the installation.

B. Other Video Drivers

Video Driver Installation for IBM OS/2

The ATI OS/2 video driver is to be used for the English version of OS/2 only.

To install ATI video drivers for OS/2 or OS/2 Warp, use the INSTALL program. This program checks the system for possible conflicts, sets the monitor type, and installs the enhanced display driver.

To run the INSTALL program

1. Start OS/2.
2. Check that OS/2 is using a standard VGA driver and no other applications are running.
3. Double-click the **OS/2 System** folder.
4. Double-click the **Command Prompts** folder.
5. Double-click the **OS/2 Full Screen** object.
6. Insert the ASUS Support CD.
7. Type **D:** <Enter> (assuming D is your CD-ROM driver).
8. Type **CD ATI\UTILITY** <Enter>. Type **OS2INST** <Enter>

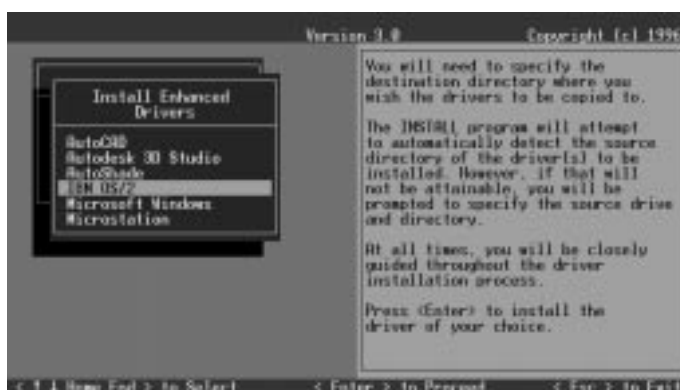

9. Select **Utilities Installation** from the Main Menu.
This copies the utilities onto your hard drive.
 10. Press <Enter> to select the default destination directory.
 11. When prompted, let the INSTALL program make changes to your Autoexec.bat file.
 12. Select **QUICK SETUP**.
You need to select QUICK SETUP to specify a monitor. Proper monitor selection is necessary for correct resolution and refresh rate operation.
 13. Select your monitor from the list.
or
If you do not see your monitor listed, see **Custom Monitor Configuration..**
- After you have selected a monitor, you are ready to copy the enhanced driver files.

B. Other Video Drivers

To copy the driver files

1. Select Drivers Installation from the Main Menu.
2. Select **IBM OS/2** from the list of applications.
3. Select **Install** for the correct version of OS/2.
4. Press <Enter> to select the default destination directory or specify a destination directory for the OS/2 driver files.
5. After the files have been copied, press any key.
6. Press **ESC** to exit.
You are now ready to install the enhanced driver for OS/2.

To install the driver for OS/2

1. In the OS/2 full-screen command prompt, type **DSPINSTL** <Enter>.
2. When the Display Driver Install panel appears, select **Primary Display**. Click **OK** to bring up the driver selection list.
3. Select the latest ATI driver version from the list, and click **OK**.
4. In the Monitor Configuration Selection Utility, select **Install Using Defaults for Monitor Type**, then click **OK**.
5. When the source directory panel appears, choose **Change** and specify the location of the driver. (The default location is C:\MACK_OS2.)
6. Click **SET**.
7. Click **INSTALL**.

B. Other Video Drivers

Select System Information (optional)

The program will check the system for possible conflicts with the device, and display both the device and system configurations in the INFO BOX. In case of a conflict, it will issue a warning and suggest possible corrective actions.

Your onboard video device is PCI Plug-and-Play compatible: your system will automatically allocate system resources and resolve possible conflicts between your Plug-and-Play compatible mach64 accelerator device and other expansion cards.

System Information

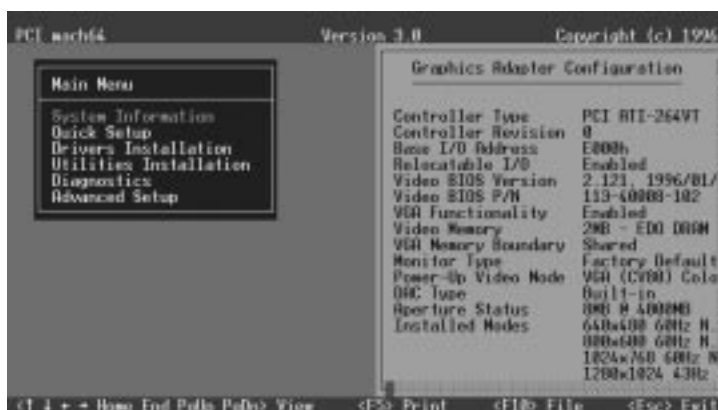

Quick Setup (optional)

Select Quick Setup to configure the accelerator device to work with your monitor. As you highlight each monitor, the display specifications for that monitor type are listed in the INFO BOX. Proper monitor selection is necessary for correct resolution and refresh rate operation. You have four options to choose a correct Monitor Type.

Selecting Your Monitor Type: Factory Default/Apple.../IBM.../MIT.../NEC.../VESA-Std.../Generic.../Read VDIF.../Custom...

Select Read VDIF... If you have a VDIF file for your monitor and wish to use its parameters to automatically configure the mach64. Additional VDIF details are provided later in this chapter, in the section: *VDIF Files*

Select Custom... if none of the above applies to you, or you wish to manually configure the settings. Please refer to the information provided later in this chapter in the section: **Custom Configuration**

Notes On Refresh Rates:

- A higher refresh rate reduces screen flicker, and therefore reduces eye strain. Not all refresh rates are supported at all color depths. Refer to the features section for specifications of your ASUS 264 Series Device.
- The resolution used by your software application is independent of the refresh rate. Resolution depends on the installed software driver and selected display mode.

B. Other Video Drivers

VDIF Files (optional)

VDIF files are VESA Display Information Format files. They contain all the necessary configuration parameters for getting optimal resolution and refresh rate operation from the specified monitor. Consult your monitor manufacturer for availability of VDIF files.

If you have a VDIF file for your monitor, select it. The **INSTALL** program will read the VDIF file and automatically configure the device to properly work with your monitor.

Procedure:

1. Start the **INSTALL** program.
2. Select **Quick Setup** and press <Enter>.
3. Insert into a floppy drive the disk containing the VDIF file.
4. Select **READ VDIF...** and press <Enter>.
5. Type in the location of the VDIF file (typically A: or B:). **INSTALL** will read the file and configure the device to support your monitor according to the VDIF specification.

Custom Configuration

If your monitor is not listed in the Monitor Selection Menu, or you are not using DDC or VDIF, you can set up display modes, i.e., resolutions and refresh rates, on the device using the Custom... option. This option is useful even if you had selected a monitor from the list. For example, you can modify the screen centering or refresh rate on one resolution, and not change the other resolutions.

Procedure:

1. Start the **INSTALL** program.
2. Select **Quick Setup** and press <Enter>.
3. Select **Custom...** and press <Enter>.
4. Pick a resolution, then a refresh rate. You will see a box outline.

WARNING: Using the wrong refresh rate may permanently damage your monitor. For more information, please refer to the manual.

NOTE: An incorrect Monitor Type setting may damage your monitor. Review your monitor specifications before making a selection from the Monitor Selection Menu. Do not exceed the monitor specifications. Using a refresh rate (i.e., vertical frequency) that is higher than specified may damage your monitor. The manufacturer will not be liable for any damage caused by incorrect settings. Consult your monitor manual to determine the highest refresh rate for each resolution that your monitor supports. A scrambled screen indicates your monitor is not capable of the selected display mode. In which case, you should immediately press <Esc> to exit.

TIP: If the monitor produces a scrambled display, try a lower refresh rate. If it is already at the lowest refresh rate, set that resolution to Not Supported.”

5. Adjust the size and position of the box outline. Press <Enter> to accept.
6. Repeat steps 2 and 3 until you are satisfied with the box outline for all the resolutions. When finished, remember to exit and save the settings.

B. Other Video Drivers

Advanced Setup (optional)

If you wish to fine tune its settings for your monitor and system type, select Advanced Setup from the Main Menu. On-screen context sensitive help is displayed as you highlight each Advanced Menu item.

WARNING! The Advanced Configuration option allows you to use certain features that may add additional performance to your device. However these options may not be compatible with your system. If problems appear after an advanced option is changed, returning the device to factory defaults will rectify the situation.

Factory Defaults

The device can be reset to factory defaults by pressing <Shift>+<F7>.

Saving Your Configuration

Once you have finished configuring the necessary parameters described above, save them by pressing <F10>.

Diagnostics

All installed graphics modes in the mach64 accelerator can be viewed and tested, by running the INSTALL program from the DOS prompt, or by running a diagnostics program called M64DIAG.EXE. Do not run it in a windowed or full-screen DOS box. In the INSTALL program, select Test Graphics Adapter from the Diagnostics... option of the Main Menu. The Test Graphics Adapter menu has the following options:

- VGA Tests ...
- Accelerator Tests ...

Any time you suspect there is a problem, especially during installation, run the above tests. The information provided in this appendix will enable you to solve most problems.

B. Other Video Drivers

Troubleshooting

System Lockup

- If you are using a memory manager such as QEMM or 386MAX you need to modify the command line in the CONFIG.SYS file so that the address of the graphics device video BIOS, C000 - C7FF, is excluded. For example, add “EXCLUDE = C000 - C7FF” to the command line.
- Remove all unnecessary boards.
- Disable shadow RAM.
- Ensure that the board is seated correctly and that the device has been installed using the proper utilities.
- Try the device in a different system and reset to factory defaults using the INSTALL program. If the device works in another system, the problem is likely due to incorrect configuration.

Troubleshooting

Because a typical computer system consists of many different parts, difficulties may arise from a combination of items, from software or hardware installation, to monitor compatibility. Listed below are several checks you can make to help determine what the problem is.

Test Patterns OK; Applications Do Not Sync

The wrong monitor type has been selected. Change the settings in the INSTALL program.

Windows Driver Not Installing Properly

Windows must be running in 386 Enhanced Mode. Incompatible memory managers may prevent Windows from starting in enhanced mode. If this occurs, remove the offending driver or memory manager.

Windows NT 4.0 driver cannot pass “Test VGA.”

Please bypass “Test VGA” then load ATI drivers after completing installation.

AutoCAD Driver Not Installing Properly

If using a 386, ensure that AutoCAD has been configured for the appropriate ADI driver. The protected mode driver requires extended memory.

Error Codes and Messages

Problems and solutions for some common errors found by the test program are provided for your reference as follows:

B. Other Video Drivers

Memory aperture test failure or Diagnostics program locks or Reboots during aperture test

If you receive an error message indicating that the memory aperture location is conflicting with your system memory, restart the INSTALL program as follows: INSTALL APMAP <Enter>. Now when you enable Memory Aperture, you must select a location above but not overlapping System Memory (S), BIOS (B) or Reserved (R) locations. Not applicable for ISA cards.

Desired resolution is disabled and displayed in gray

A mode displayed in gray means that the BIOS is told this mode is not available, based on the device configuration. Reinstall using custom monitor selection.

Menu item is disabled and displayed in gray

The test program has determined that the mode or test is not available under the current configuration. Aperture tests are not available if the aperture is disabled, and CRT mode and pixel depth are determined by current installation, DAC type, memory size, and memory type.

Adapter not detected

This message should only occur when a mach64 ASIC is not detected. If this message occurs and a mach64 board is present, it may indicate an I/O conflict, conflicts between the Extended Memory Manager (EMM) and the video ROM. Try removing all other boards from the system and booting from a plain DOS disk. Try excluding the video BIOS address (C0000-C7FFF) from the memory manager. Refer to the documentation furnished with the memory manager software for information.

Any FIFO test error

The effects of a bad command FIFO should be visible. (e.g., the screen does not come up, or it displays garbage.)

Quick memory test error

Run Detailed RAM Test to confirm the error and identify the address of the error.

Detailed memory test error.

Run Detailed RAM Test several times to confirm the error and take notes of any messages and error codes.

DAC LUT test failure.

An error has occurred while testing the DAC LookUp Table. The problem should be visible on the top color bar of any 8bpp mode.

ROM checksum error.

An error has been detected in the ROM.

Draw sequence failure.

An error has occurred in the draw engine. If the error is intermittent, it might indicate a marginal RAM failure. The effects of this failure may not be immediately apparent.

B. Other Video Drivers

Windows 95 mach64 enhanced display driver

The Windows 95 mach64 enhanced display driver is capable of using monitor timing data contained within Windows 95. This data is selected by configuring a monitor type at Windows 95 installation time or via the “Settings” page of the display properties sheet.

The Windows 95 mach64 enhanced display driver may incorrectly interpret Windows 95 monitor timing data for some older monitors which require interlaced modes. This may cause some options to be disabled. A solution to this problem is to select one of the “(Standard monitor types)” available via the settings page of the display properties sheet.

If you change the selected monitor type via the “Settings” page of the display properties sheet the new timing data may not take effect until after restarting Windows 95. A solution to this problem is to always restart Windows 95 after changing the monitor type.

In Windows 95, display drivers can be installed via the “Add New Hardware” wizard. This is not recommended because when the Windows 95 mach64 enhanced display driver is installed via the “Add New Hardware” wizard the “Settings” page does not get installed into the mach64 display adapter property sheet.

Windows 95 property page problems

While adjusting monitor settings in the Adjustment page of the Display Properties sheet, your monitor could become unreadable. If this occurs, press the ESC key to return to your previous monitor settings.

ATI Video Player Notes

Why can my Video Player not execute in Windows 3.1 ?

The Video Player needs at least 600K DOS CONVENTIONAL MEMORY. You can try to close some programs to acquire more memory to use. If it still happens, return to DOS and run “MEMMAKER” in your DOS directory to modify your memory configuration. Quitting some DOS TSRs (Terminate and Stay Resident) programs also helps.

After installing Xing MPEG Player, my ATI Video Player can not play Video CD even standard MPEG files.

Xing MPEG Player and ATI Video Player can not be installed together. They conflict with each other. The previously installed player will work abnormally. You can re-install ATI Video Player to recover it.

Why can I not use the TV output function in Windows 95?

You need to make sure that your resolution is 800x600 or under and refresh rate equal to or less than 60Hz in NTSC and 50Hz in PAL.

B. Other Video Drivers

Other Problems & Actions

My monitor is not capable of high resolution or refresh rate.

It depends on the display characteristics of your monitor. Consult your monitor documentation for the proper configuration.

After installing the driver, Windows 95 doesn't prompt me to restart and the driver still doesn't work after I restart my computer.

You may have installed similar drivers before. Try the following steps to install:

1. Right-click **My Computer** on the desktop.
2. Select **Properties**. The **System Properties** dialog box appears.
3. Click the **Device Manager** tab. Be sure that **View devices by type** is selected.
4. Double-click **Display adapters**. If **Display adapters** does not appear, jump to step 8 and continue.
5. The name of your device will be listed in the box. Double-click it.
6. The properties box of your device appears. Click the **Driver** tab.
7. Click **Change Driver...** and follow the installation steps.
8. Click **Other devices**. Your device should be listed.
9. Click the name of your device to bring up the properties box of your device. Select the **Driver** tab.
10. Click **Change Driver...** and follow the installation steps.

After installation and restarting, Windows 95 informs me that the display setting is still incorrect.

There may be a conflict between a previous and the current display drivers. This is caused by the incomplete removal of the previous display driver. Try the following steps to remove it:

1. Right-click **My Computer** on the desktop.
2. Select **Properties**. The **System Properties** dialog box appears.
3. Click the **Device Manager** tab. Be sure that **View devices by type** is selected.
4. Double-click **Display adapters**.
5. You will find two (or more) conflicting adapters.
6. Disable all previous adapters by selecting them and clicking **Remove**.
7. Close Device Manager and restart Windows 95.
8. Your display driver should work correctly this time.

C. ATI Player

ATI Player

ATI Player and control panel (Win3.1x and Win95)

If VIDEO drivers are installed, for playing video clips, the ATI Player icon will appear in the DeskTop. Double click on this icon to bring up the Video Screen as shown here: (Detailed button definitions are shown when holding the cursor over the individual buttons for a few seconds.)

The Task Control Panel

The Task control panel indicates what mode the player is in and what it's doing. (Your Task control panel may not look exactly like the illustration-only installed or available features will have controls.)

Under win31 environment



Under Win95 environment

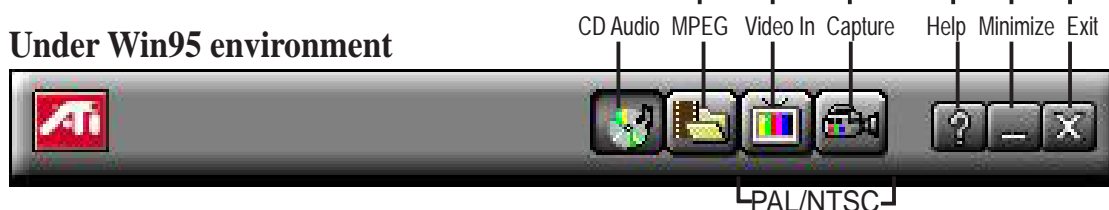

CD Audio—Play standard audio CDs (only in Windows 95)



MPEG Playback—Play MPEG and AVI video files



Video In (Tuner button)—Display live video sources (available only on video model)



Capture—Capture still images, video sequences, or audio-only (available only on video model)

Features

The question mark on top right of the Video Screen allows inspection into each button on the control panel. Click on the “?” then on a button that you would like to know about.

C. ATI Player

Playing Audio CDs (Only in window 95)



Click the Audio CD button in the Task control panel to switch to Audio CD mode



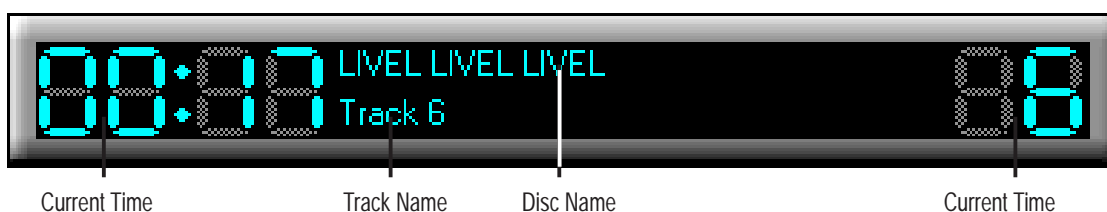

The Audio CD player has its own control panel for controlling the audio CD playback. You can use the Audio CD panel to play standard audio CDs. Advanced features such as Random play, Intro play, which plays the first ten seconds of each track, and Loop play are available.



The Audio CD player has its own display.

To play an audio CD

1. Insert the audio CD into your CD-ROM drive.
2. In the Audio CD panel, click the Setup Dialogs button 
3. Click the Disc Info tab.
4. From the Available Tracks list, add or remove tracks as desired.
The Play List displays your current selections.
5. Click OK.
6. In the Audio CD panel, click the Play button 

The Audio CD player uses Windows 95 standard INI file to store disc names, track names, and the play list. You can use the Setup dialog to enter the name of the artist and the disc.

C. ATI Player

Playing Media Files



Click the MPEG Playback button in the Task control panel to switch to playback mode.



The Control panel changes to the Playback panel.

To view/hide the Playback panel in Full Screen mode, press F2.

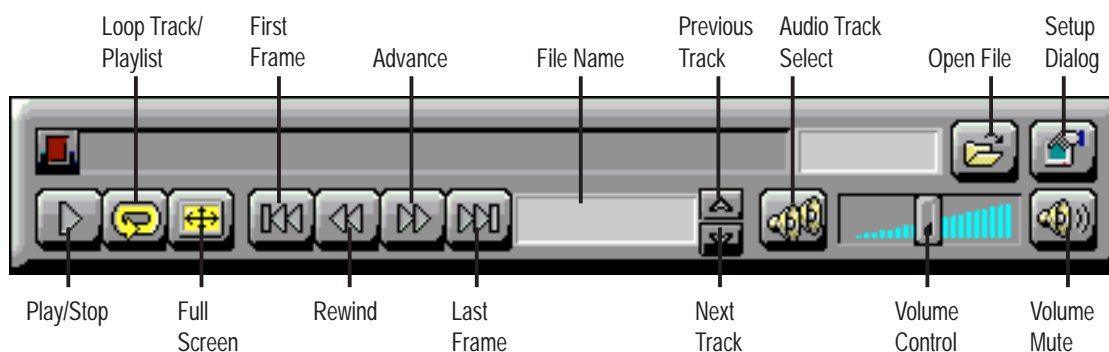

You can use the Media Playback panel to play the following media files:

- MPEG-1 digital audio and video, including Karaoke dual-channel audio, CDi, Games, and reference application titles
- *.AVI video files

To play a file

1. In the Playback panel, click the File Open button
2. Select a file from the list.
3. Click Add, then click OK.
4. Click the Play button
5. The file plays in the Display panel.

Playing Interactive Discs (Video CD 2.0)

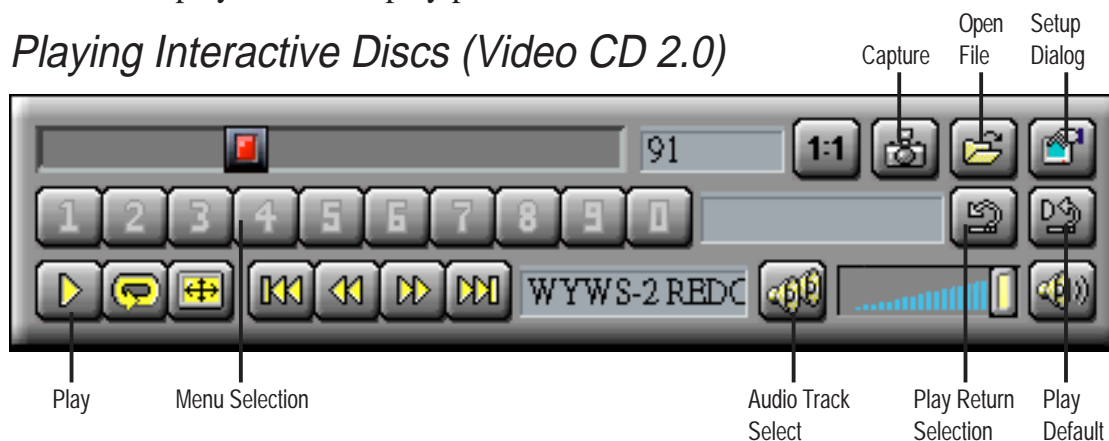

When playing Video CD 2.0 discs, the Control panel changes to this interactive panel.

C. ATI Player
Windows 95/3.x

(This page was intentionally left blank)

D. Audio Driver

First Time Installation

When starting Windows 95/98/NT 4.0, the operating system will automatically detect the ESS Solo-1 PCI Audio Driver.

For Windows 95

1. When the *New Hardware Found* screen prompts for a driver, select **Driver from disk provided by hardware manufacturer** and insert the ASUS Support CD into your CD-ROM drive.
2. Click **OK**.
3. Click **Browse**.
4. Locate the **D:\audio\w95** folder (where D is your CD-ROM Drive) and click **OK**.
5. Click **OK** again and the driver files will be copied.
6. Click **Yes** to restart the computer.

For Windows 98

1. When the *Add New Hardware* screen prompts you for a driver, select **Display a list of all the drivers in a specific location, so you can select the driver you want** and click **Next**.
2. Select **Sound, video and game controllers** and click **Next**.
3. Click **Have Disk**.
4. Insert the ASUS Support CD into your CD-ROM drive.
5. Click **Browse**.
6. Locate the **D:\audio\w95** folder (where D is your CD-ROM Drive) and click **OK**.
7. Click **OK** again and the driver files will be copied.
8. Click **Yes** to restart the computer.

D. Audio Driver

First Time Installation

When starting Windows 95/98/NT 4.0, the operating system will detect that you have a new PCI Multimedia Device.

Click **Next** when the *Update Device Wizard* screen appears.



Click **Other Locations** to direct the wizard to the audio driver files.



Click **Browse** to locate the `\audio\W95` folder for Windows 95/98 or the `\audio\Nt40` folder for Windows NT on the ASUS Support CD.

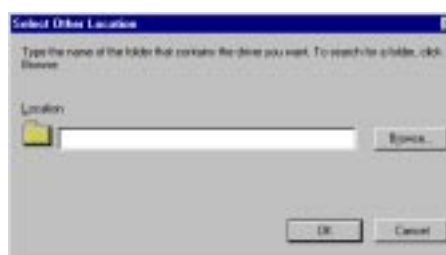

Click **OK** to select the folder.

Click **OK** and your device and driver location will be shown. Click **Finish**.



You will be prompted to insert the ASUS Support CD. Click **OK**.



Click **Browse** and locate the `\audio\W95` (or `\audio\Nt40`) folder on the ASUS Support CD again.

Follow the self-explanatory instructions to finish your driver installation.

D. Audio Driver

For Windows NT 4.0

1. Run the Windows NT “Multimedia” program located in **Control Panel**.
(**Start->Settings->Control Panels->Multimedia**)
2. Click the **Devices** tab.
3. Select **Audio Devices** under Multimedia Devices.
4. Click **Add**.
5. Select **Unlisted or Updated Driver** under List of Drivers.
6. Click **OK**.
7. When Windows prompts you for the driver location, click **Browse**.
8. Locate the **D:\audio\Nt40** folder (where D is your CD-ROM Drive).
A list of audio drivers will be displayed.
9. Select the driver for your audio chipset and click **OK**.
Windows will prompt you to restart.
10. Click **OK** to restart the computer.

(This page was intentionally left blank)

E. Audio Software

Audio Rack Installation

Reinsert your CD or double click on your CD drive icon in My Computer to bring up the autorun screen or run Setup.exe in the root directory of the CD. Click **Install Audio Utilities** from the main menu.

Audio Rack Introduction

The *AudioRack32* enables you to take advantage of your computer's audio capabilities with all of the controls conveniently in one compact space. You can play audio CDs, wave files (in .WAV and .AUD formats), and MIDI files (in .MID and .RMI formats). With the multisource Audio Mixer, you can blend these sources with line-in and microphone sources any way you choose. You can then record your creations as wave files and edit them with the Audio Recorder.

The *AudioRack32* has six main parts:

- Command Center—customizes the appearance of the *AudioRack32*.
- Audio Mixer—controls the volume and balance of the *AudioRack32* devices.
- Digital Audio Player—plays and records files in the .WAV format.
- MIDI Player—enables you to play MIDI files.
- Compact Disk Player—enables you to play audio CDs on a CD-ROM drive.

In addition, the *AudioRack32* has a miniature mode enabling you to control the *AudioRack32* while using minimal screen space.

The Audio Recorder is a separate application from the *AudioRack32*. It can be used to add effects and edit files recorded with the Digital Audio Player or by the Audio Recorder itself. The Audio Recorder can be launched from the *AudioRack32*'s Digital Audio Player or on its own.



E. Audio Software
Introduction

E. Audio Software



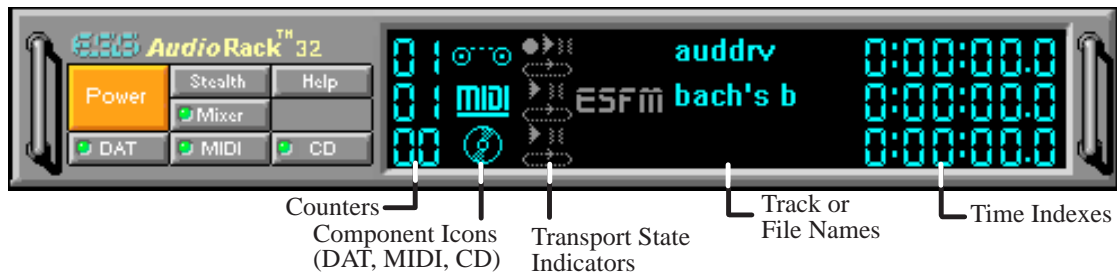



The Command Center



Introduction

The Command Center controls which parts of the *AudioRack32* are displayed. You can display or hide any part of the *AudioRack32* you choose, customizing its appearance to suit your needs or desires. It also displays information on the status of the different audio components.

The Command Center Controls

-  closes the *AudioRack32* window.
-  enables the Miniature mode, minimizing the *AudioRack32* display.
-  displays or hides the Digital Audio Player.
-  accesses On-line Help.
-  displays or hides the Compact Disk Player.
-  displays or hides the Audio Mixer.
-  displays or hides the MIDI Player.

The Command Center Display

Counter: shows you which track or file in the playlist the component is playing.

Component Icon: is displayed when the associated component is shown and is not displayed when the component is hidden.

Transport State Indicator: shows the state of a component. It indicates when the component is playing, paused, has the Auto Repeat enabled, or in the case of the Digital Audio Player, is recording.

Track or File Name: shows the name of the current track or file in the playlist.

Time Index: displays the amount of time elapsed for the track or file in hours, minutes, seconds, and tenths of a second.

E. Audio Software





The Miniature Mode



Introduction

The Miniature mode is designed to give you full control of the *AudioRack32* while using a minimum of space. You are able to effectively use the *AudioRack32* and still have enough room on your desktop to run other applications. In the Miniature mode, you can play, pause, stop, and control the master volume of the *AudioRack32*.

The Miniature Mode Controls

-  stops currently playing tracks or files of active components.
-  plays currently loaded tracks or files of active components.
-  pauses currently playing tracks or files of active components.
-  calls a popup menu where you can restore the *AudioRack32*, invoke the **Always on Top** command, select active components (DAT, MIDI, or CD), or exit the *AudioRack32*. The Stop, Pause, and Play buttons affect components that are currently active.



 controls the master volume.

E. Audio Software

The Audio Mixer



Introduction

The Audio Mixer has two modes: Playback mode and Record mode. You can use these two modes to fully control which of your audio sources you are listening to or recording, how loud each of those sources are and how they are balanced. Each audio source has its own module with mute, balance and volume controls.

In addition, the Audio Mixer provides special effects controls for chorus, reverb, treble, bass, and 3-D effects.

The Audio Mixer Controls

The two Playback and Record toggle buttons are used to switch between Playback mode and Record mode.

The Effects toggle button switches the display to the effects panel where you can use the buttons to enable and disable effects and the sliders to control the amount of the effect.

There are a number of audio source modules displayed on the Audio Mixer. The exact number displayed depends on the capabilities of your hardware. Each module has three controls:



a slider to adjust the balance

a slider to adjust the volume

a button for muting

Modules that your hardware may provide for are: Master, Line, Wave, Mic, CD, MIDI, and AuxB.

E. Audio Software















The Digital Audio Player



Introduction

The Digital Audio Player enables you to play, record, and compress sound as .WAV files. In addition, you can play .AUD files. The .WAV files use PCM, which is the Windows' audio file format. The .AUD format uses ESPCM' compression to produce an audio file. Files are written directly to your hard disk as you record, enabling you to record very large files. Your only limitation is the amount of free space on your hard disk. The voice activation feature is useful for recording any kind of intermittent audio. The Digital Audio Player provides a choice of linear PCM (8 or 16 bit) recording. Note that you have additional options using the Audio Recorder, which is invoked by the **Edit** button.

The Digital Audio Player Controls

-  starts recording to your hard disk.
-  goes to the end of the wave file or to the next file in the current playlist.
-  plays the wave file currently loaded.
-  enables or disables the Auto Repeat.
-  activates or deactivates the Pause
-  opens the Audio Recorder window.
-  stops the file currently playing.
-  opens the Set Playlist dialog box.
-  goes back one second in the wave file.
-  starts a new file by opening the New Options dialog box.
-  goes forward one second in the wave file.
-  brings up the Open file dialog box in order to load a file into the Digital Audio Player.
-  goes to the beginning of the wave file or to the previous file in the current playlist.
-  saves an audio file.

The Digital Audio Player Display

 The Level Meter displays the output from the left (top) and right (bottom) channels when a wave file is played.

 By clicking on the image of the tape deck, you can display information about the file currently loaded in the Digital Audio Player. The display tells you the file name, size, number of bits per sample, sample rate, and whether the file was recorded in stereo or mono. Click again to return to the image of the tape deck.

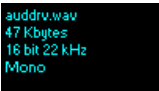
audrv.wav
47 Kbytes
16 bit 22 kHz
Mono

E. Audio Software

The MIDI Player



Introduction

The MIDI Player enables you to play MIDI files with the .MID or .RMI file extensions. These MIDI (Musical Instrument Digital Interface) files can be produced by sequencer programs and then played back using the MIDI Player. You can also mix MIDI files with other audio sources. Or you can compile MIDI files in a playlist and play them back in any order you choose.

The MIDI Player Controls

 plays the MIDI file currently loaded.

 goes back one file in the playlist.

 activates or deactivates the Pause

 goes forward one file in the playlist.

 stops the file currently playing.

 enables or disables the Auto Repeat.

 goes back one second in the MIDI file.

 opens the Set Playlist dialog box.

 goes forward one second in the MIDI file.

The MIDI Player Display

By clicking on the image of the floppy drive, you can display the length and name of the current MIDI file in the playlist. Click the display to return to the image of the floppy drive.

 The MIDI Player has an indicator to show when you are listening to ESFM. When the ESFM light to the left of the playlist button is lit, the MIDI Player is using ESFM synthesis. ESFM performs superior-quality music synthesis compared to that of traditional FM, producing richer timbre and greater depth of instrument voices. **FM synthesis is a lower quality technology compared with wavetable synthesis. This card supports wavetable synthesis therefore FM is not supported on this card.**

E. Audio Software











The Compact Disk Player



Introduction

If you have a CD-ROM drive, you can play audio CDs. Check your hardware manual about setting up CD audio hardware and drivers. The Compact Disk Player uses intelligent CD playlist management: The Compact Disk Player maintains a record of each CD you play. It remembers the last playlist you used with each CD and loads that playlist automatically whenever you insert that CD.

The Compact Disk Player Controls

-  plays the MIDI file currently loaded.
-  goes back one file in the playlist.
-  activates or deactivates the Pause
-  goes forward one file in the playlist.
-  stops the file currently playing.
-  enables or disables the Auto Repeat.
-  goes back one second in the MIDI file.
-  opens the Set Playlist dialog box.
-  goes forward one second in the MIDI file.
-  ejects the CD from the CD-ROM drive.

E. Audio Software

The Audio Recorder















Introduction

The Audio Recorder enables you to record, compress, store, and play back voice, music, and other sound. It provides settings for sound attributes such as mono/stereo, compression level, and sampling rate. You can use it to embed sound objects in documents created in applications that support object linking and embedding (OLE).

The Audio Recorder's edit, record, and playback capabilities are compatible with the Windows Sound Recorder and other recorders that record and play back in the PCM format. Like the Digital Audio Player, the Audio Recorder can record and play back .WAV and .AUD files. The Audio Recorder allows a choice of compression from low, medium, and high ESPCM and ADPCM.

The Audio Recorder Controls

-  starts a new audio file.
-  inserts the Clipboard audio at the cursor or replaces the selected portion.
-  opens an audio file.
-  mixes the Clipboard audio with the audio beginning at the cursor.
-  saves an audio file.
-  starts recording.
-  reverses the last change you made to the current audio file.
-  plays the currently loaded audio file.
-  removes the selected portion of the audio file and stores it on the Clipboard.
-  pauses the file currently playing or recording.
-  copies the selected audio portion to the Clipboard without removing it.
-  determines the cursor position on the waveform.

The Audio Recorder Display



The four text boxes under the tool bar display the length in seconds of the selected part of the currently loaded file, the total length in seconds of the current file, whether the file is in stereo or mono, and the sampling rate in kilohertz.

To the right of the text boxes is a box displaying the icon associated with the particular file. If a file has no icon associated with it, it is given a default icon.

E. Audio Software

Release Notes

This information is provided for convenience only. Information here is subject to change without prior notice. View the installation CD for any updated information in Readme text files. The AudioRack also provides detailed online help (click the **Help** button on the “Command Center”)

Disable Eject Button on the CD Player

Under the Windows directory in the file “auddrive.ini”, there is a string “DisableEjectButton=0” under the [cdplayer] section. If you would like to disable EJECT button on the CD player, you can change the value from 0 to 1. You need to close AudioRack and launch it again to make the new settings take effect.

Using AudioRack CD Player as Default CD Player

During installation, you will be asked if you want to use AudioRack CD player as the default CD player. Normally Windows 95 CD player is the default and will automatically run when an audio CD is inserted into the CD-ROM. If you answer “Yes”, the installation program will overwrite the value of the key [HKEY_CLASSES_ROOT]\AudioCD\shell\play\command in the registry. You may switch back to Windows 95 CD player by resetting this key value.

Configuring Playback Mixer

The onboard PCI audio device offers eight inputs for the playback mixer, including “Line”, “Wave”, “CD”, “Synth”, “Aux A”, “Aux B”, “Mic”, and “Mono In”. AudioRack can only display six of them at a time. You may configure the settings by modifying the file “auddrive.ini” in the Windows directory. Under the section [MixerRak], you can enable or disable the display of each input by setting its corresponding binary value to 1(enable) or 0(disable).

F. Software Wavetable

Install Software Wavetable (Windows 95/98)

Insert the ASUS Support CD into your CD-ROM drive or double-click the CD drive icon in **My Computer** to bring up the autorun menu or run **Setup.exe** in the root directory of your CD-ROM driver. This will bring up the main menu.

Click **Install Software Wave Table**.

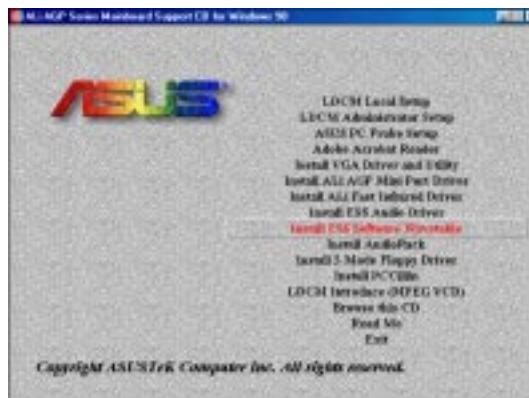

Select **Install ESS Software Wavetable** and click **Next**.



When Setup has finished installing all the necessary files on your computer, it will prompt you to restart your computer.

Select **Yes, I want to restart my computer now** and then click **Finish** to restart your computer and complete setup.



G. DMI Utility

Desktop Management Interface (DMI)

Introducing the ASUS DMI Configuration Utility

This motherboard supports DMI within the BIOS level and provides a DMI Configuration Utility to maintain the Management Information Format Database (MIFD). DMI is able to auto-detect and record information pertinent to a computer's system such as the CPU type, CPU speed, and internal/external frequencies, and memory size. The onboard BIOS will detect as many system information as possible and store those collected information in a 4KB block in the motherboard's Flash EPROM and allow the DMI to retrieve data from this database. Unlike other BIOS software, the BIOS on this motherboard uses the same technology implemented for Plug and Play to allow dynamic real-time updating of DMI information versus creating a new BIOS image file and requiring the user to update the whole BIOS. This DMI Configuration Utility also allows the system integrator or end user to add additional information into the MIFD such as serial numbers, housing configurations, and vendor information. Those information not detected by the motherboard BIOS and has to be manually entered through the DMI Configuration Utility and updated into the MIFD. This DMI Configuration Utility provides the same reliability as PnP updating and will prevent the refreshing failures associated with updating the entire BIOS.

Starting the ASUS DMI Configuration Utility

The DMI Configuration Utility (DMICFG2.EXE) must be used in real mode in order for the program to run, the base memory must be at least 180K. Memory managers like HIMEM.SYS (required by windows) must not be installed. You can boot up from a system diskette without AUTOEXEC.BAT and CONFIG.SYS files, "REM" HIMEM.SYS in the CONFIG.SYS, or press <Shift>+<F5> during bootup to bypass your AUTOEXEC.BAT and CONFIG.SYS files.

1. In Windows, copy DMICFG.EXE to your hard disk drive.
2. Restart your computer and press <Shift>+<F5> during bootup to enter safe mode command prompt.
3. Go to the directory containing DMICFG.EXE.
4. Type `DMICFG` and press <Enter> to run.

G. DMI Utility

Using the ASUS DMI Configuration Utility

NOTE: The following screen displays are provided as examples only and may not reflect the screen contents on your system.

Edit DMI (or delete)

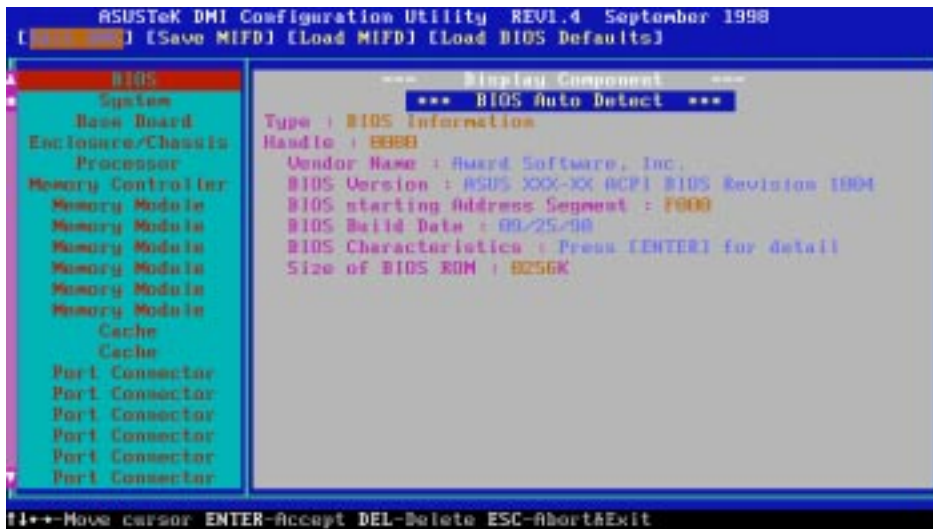

Use the ←→ (left-right) cursors to move the top menu items and the ↑↓ (up-down) cursor to move between the left hand menu items. The bottom of the screen will show the available keys for each screen. Press enter at the menu item to enter the right hand screen for editing. “Edit component” appears on top. The reversed color field is the current cursor position and the blue text are available for editing. The orange text shows auto-detected information and are not available for editing. The blue text “Press [ENTER] for detail” contains a second pop-up menu is available, use the + - (plus-minus) keys to change the settings. Enter to exit *and save*, ESC to exit *and not save*.

If the user has made changes, ESC will prompt you to answer Y or N. Enter Y to go back to the left-hand screen *and save*, enter N to go back to left-hand screen and *not save*. If editing has not been made, ESC will send you back to the left hand menu without any messages.

Notes

A heading, *** BIOS Auto Detect ***, appears on the right for each menu item on the left side that has been auto detected by the system BIOS.

A heading, *** User Modified ***, will appear on the right for menu items that have been modified by the user.



G. DMI Utility

Save MIFD



You can save the MIFD (normally only saved to flash ROM) to a file by entering the drive and path here. If you want to cancel save, you may press ESC and a message “Bad File Name” appears here to show it was not saved.

Load MIFD



You can load the disk file to memory by entering a drive and path and file name here.

Load BIOS Defaults



You can load the BIOS defaults from a MIFD file and can clear all user modified and added data. You must reboot your computer in order for the defaults to be saved back into the Flash BIOS.

(This page was intentionally left blank)