

MIS - 6117

ATX LX6 Mainboard

Designed for Pentium III Processor

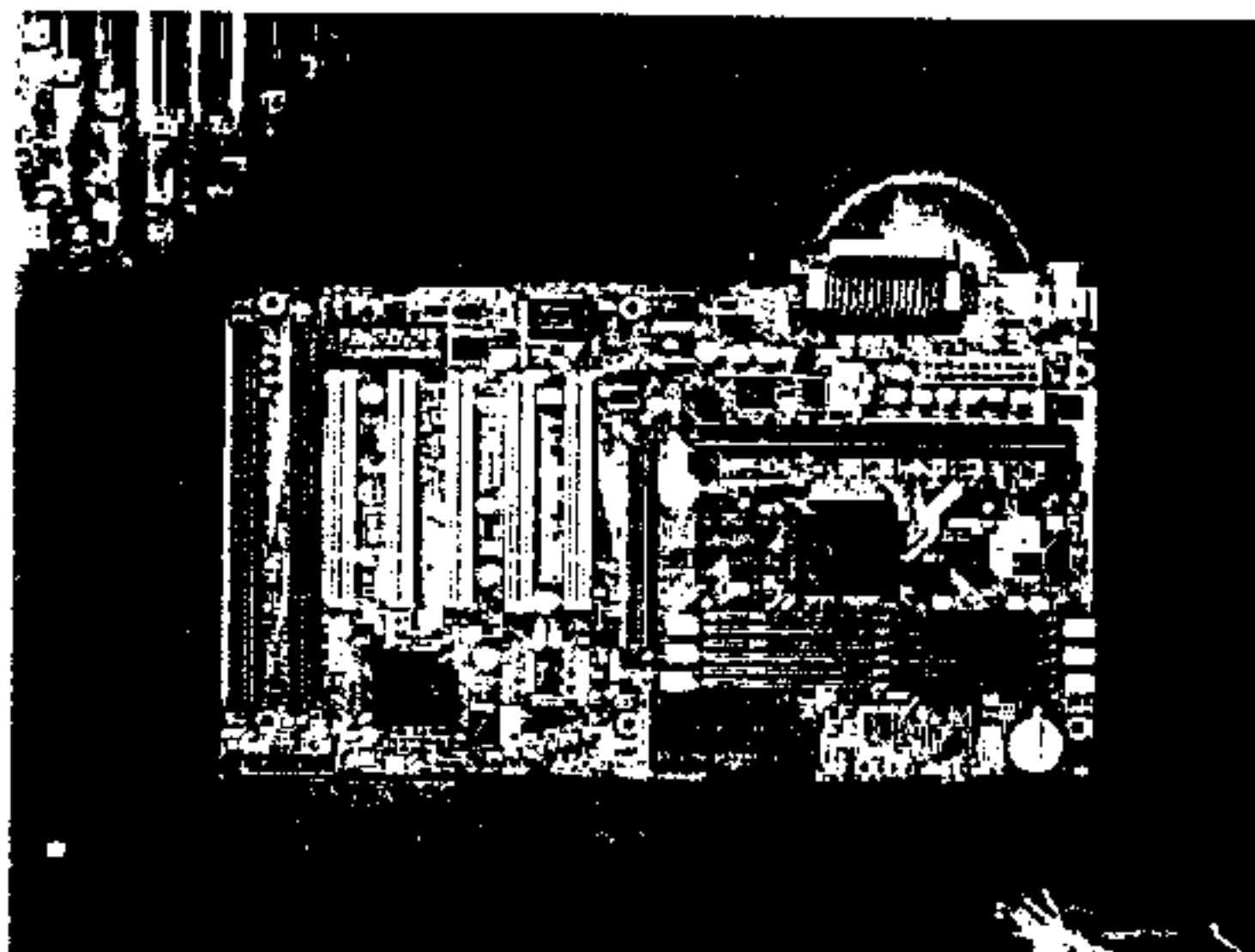

User's Manual

- The specification is subject to change without notice.
- Pentium is a registered trademark of Intel Corporation.
- All brand names are registered trademarks of their respective owners.

Chapter 1

INTRODUCTION

The MS-6117 is a high-performance personal computer mainboard based on the Pentium® II processor.

The mainboard uses the highly integrated Intel® 82440LX AGPset which optimize the system bandwidth and concurrency with the implementation of Quad Port Acceleration (QPA). QPA provides 4-port concurrent arbitration of the processor bus, graphics, PCI bus and SDRAM.

The Intel® 82371AB chipset integrates all system control functions such as ACPI (Advanced Configuration and Power Interface). The ACPI provides more Energy Saving Features for the OSPM(OS Direct Power Management) function. The Intel® 82371AB chipset also improves the IDE transfer rate by supporting Ultra DMA/33 IDE that transfers data at the rate of 33MB/s.

The mainboard also supports the LM78 System Hardware Monitor Controller as optional function. The LM78 function includes: CPU /power supply/chassis fan revolution detect, CPU/system voltage monitor, system temperature monitor, and chassis intrusion detect(optional).

1.1 Mainboard Features

CPU

- Slot 1 for Pentium® II processor.
- Supports 200MHz, 233MHz, 266MHz, 300MHz, and 333MHz.
- Core/Bus ratios are x2, x2.5, x3, x3.5, x4, x4.5, x5, x5.5, x6 and higher.

Switching Voltage Regulator

- On-board switching mode DC-DC Step Down Regulator.
- Conforms to Intel® VRM ver 8.1 specifications.
- Over-Voltage and Over-Current protection.

Chip Set

- Intel® 82440LX PCI Chipset.

Clock Generator

- 66.6MHz clocks are supported.

Main Memory

- Supports six memory banks using three 168-pin unbuffered DIMM sockets.
- Supports a maximum memory size of 512MB with SDRAM, or 1GB with EDO.
- Supports ECC(Error Check Correct) and EC(Multiple-Bit Error Correction) function.
- Supports 3.3v Extended Data Output (EDO) and SDRAM DIMM.

Slots

- One AGP(Accelerated Graphics Port) slot.
 - AGP specification compliant
 - AGP 66/133MHz 3.3v device support
- Five 32-bit Master PCI Bus slots and two 16-bit ISA bus slots wherein one shared slot that can be used as ISA or PCI.
- Supports 3.3v/5v PCI bus Interface.

On-Board IDE

- An IDE controller on the Intel® 82371AB PCI Chipset provides IDE HDD/CD-ROM with PIO, Bus Master and Ultra DMA/33 operation modes.
- Can connect up to four IDE devices.

On-Board Peripherals

- On-Board Peripherals include:
 - 1 floppy port supports 2 FDD with 360K, 720K, 1.2M, 1.44M and 2.88Mbytes.
 - 2 serial ports (COMA + COMB)
 - 1 parallel port supports SPP/EPP/ECP mode
 - 2 USB ports
 - 1 IrDA connector for SIR.

BIOS

- The mainboard BIOS provides “Plug & Play” BIOS which detects the peripheral devices and expansion cards of the board automatically.
- The mainboard provides a Desktop Management Interface(DMI) function which records your mainboard specifications.

On-Board System Hardware Monitor(LM78)

- CPU/Power Supply/Chassis Fan Revolution Detect
- CPU Fan Control (the fan will automatically stop when the system enters suspend mode)
- System Voltage Detect
- Chassis Intrusion Detect(reserved)
- Display Actual Current Voltage

RTC

- Non-Volatile RTC.

Keyboard Connector

- PS/2® keyboard interface and PS/2® mouse interface.

Dimension

- ATX Form Factor: 30.5cm(L) x 18.6cm(W) x 4 layers PCB.
- Double deck I/O connectors, compatible with Intel® Venus Mainboard.

Mounting

- 6 mounting holes.

1.2 Mainboard Layout

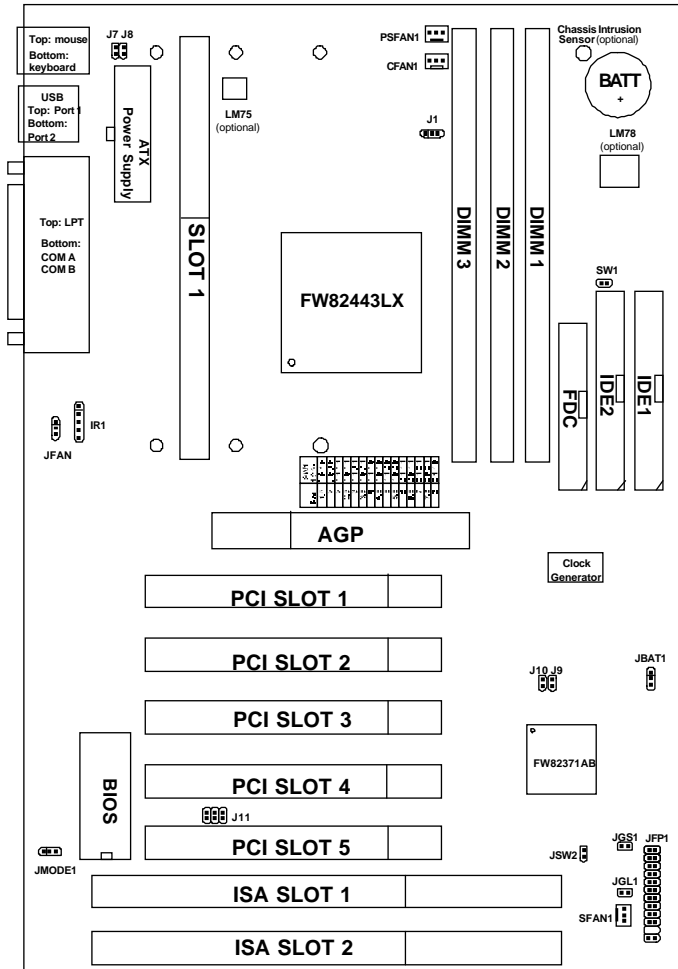

MS-6117

Chapter 2

HARDWARE INSTALLATION

2.1 Central Processing Unit: CPU

The mainboard operates with **Intel® Pentium® II processor**. The mainboard uses a CPU Slot called Slot 1 for easy CPU installation and a DIP switch (SW1) to set the proper speed for the CPU. The CPU should always have a Heat Sink and a cooling fan attached to prevent overheating.

2.1-1 CPU Installation Procedures

There are two kinds of Pentium® II processor that is currently used: the OEM version and the Boxed version. OEM Pentium® II Processor has no Heat Sink, Fan and Heat Sink Support, while the Boxed Pentium® II Processor is provided with Heat Sink w/ fan and Heat Sink Support.

A. OEM Pentium® II Processor Installation Procedures

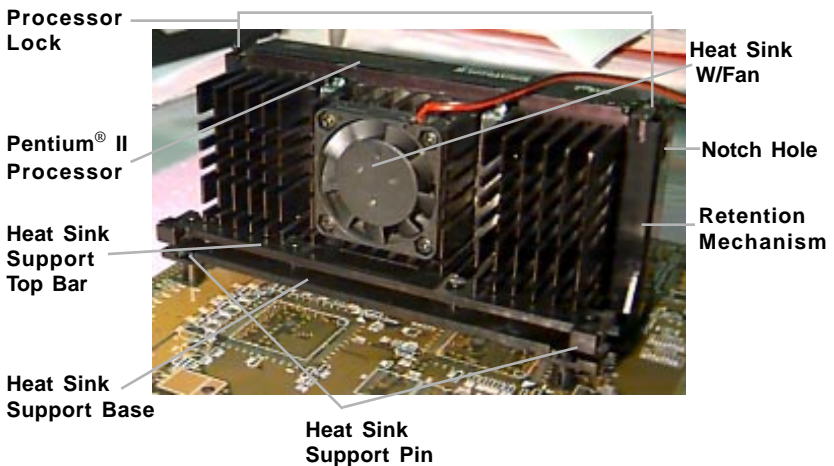

Required Things:

Pentium® II processor - Processor.

***Retention Mechanism(RM)** - Plastic Guide that holds the S.E.C. Cartridge in the Slot 1 connector.

***Retention Mechanism Attach Mount(RMAM)** - Bolt/Bridge assemblies inserted up through the bottom of the motherboard. RM secures to RMAM (2 RMAM required per RM).

***Heat Sink Support Base (HSSBASE)** - Plastic support bar mounted to the mainboard under the ATX heatsink. (One leg is always bigger than the other one)

***Heat Sink Support Pin (HSSPIN)** - Plastic pins inserted through the HSSBASE to secure it to the mainboard (2 required per Assembly).

***Heat Sink Support Top Bar (HSSTOP)** - Plastic bar that clips onto the HSSBASE through the fins on the ATX heatsink.

****Heat Sink w/ fan** - Heat Sink that can be attached to the **Pentium® II processor** with metal clip.

Note: * Provided by MSI mainboard.

** Provided by Special request.

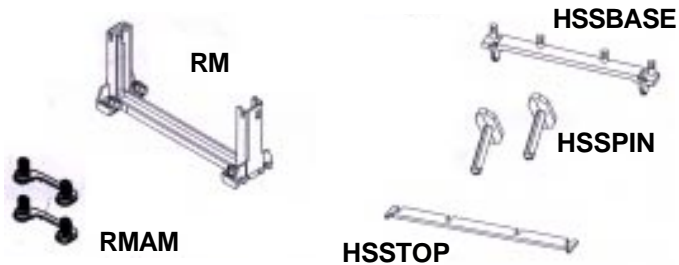

Step 1: Insert the Retention Mechanism Attach Mount at the bottom of the mainboard.

Step 2: Install the Retention Mechanism.

Look for the key on Slot 1, and match it with the Notch Key on the Retention Mechanism for proper direction. Then, attach the Retention Mechanism to the Retention Mechanism Attach Mount. Use a Screwdriver to secure the Retention Mechanism.

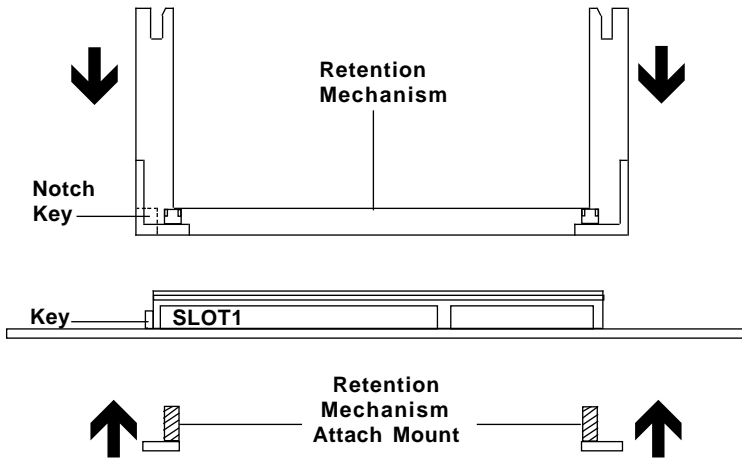

Step 3: Install the Heat Sink Support Base.

Look for the Two holes across Slot 1, and match it with the Two legs of the Heat Sink Support Base for the proper direction. Take note that one hole/leg is bigger than the other. The Four top pins of the Heat Sink Support Base should also be oriented towards Slot 1.

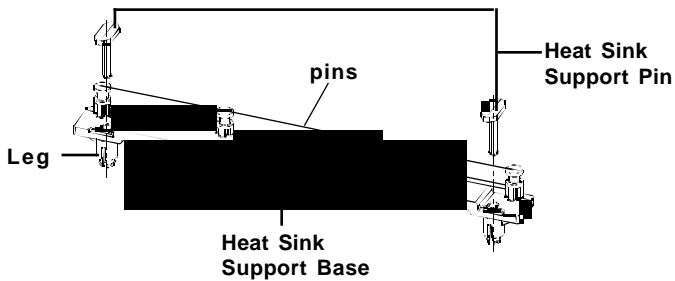

Push the Heat Sink Support Base onto the mainboard, until you hear a click sound. Check for a perfect fit.

Step 4: Install the Heat Sink Support Pin.

Push the Heat Sink Support Pins onto the two holes of the Heat Sink Support Base. Check for a perfect fit. These pins are used to secure the Heat Sink Support Base.

Step 5: Install the Heat Sink with Fan to the Processor.

Push down the metal clips, so that they are in line with the back of the Heat Sink. Be careful, so as not to detach the metal clips from the Heat Sink.

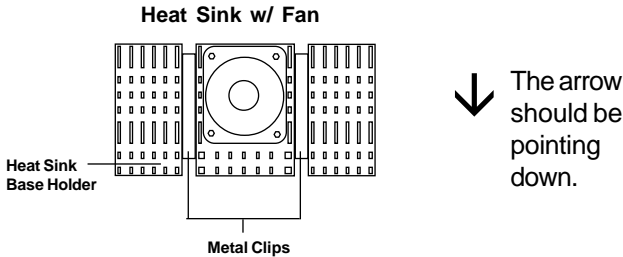

In case the metal clips are detached from the Heat Sink, re-attach them. Look for the arrow on the metal clip. This arrow should be pointing down and aligned with the Heat Sink Support Base Holder.

Attach the Heat Sink to the processor.

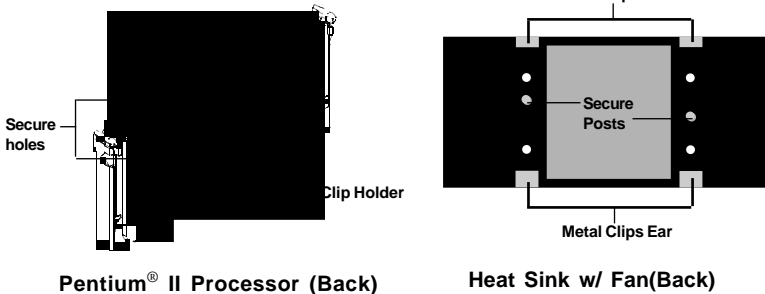

- Look at the back of the Heat Sink and take note of the 2 secure posts. Insert these 2 Secure posts to the 2 secure holes on the back of the processor.
- Align the ears of the metal clips with the clip holders on the back of the processor. Use a screw driver to push the metal clips onto the clip holders. Check for a perfect fit.

Step 6: Install the Processor.

Unlock the Processor by pushing in the Processor Locks.



Insert the Processor like inserting a PCI or an ISA card.

Step 7: Lock the Processor Locks.

Secure the CPU by pulling the Processor Locks out.

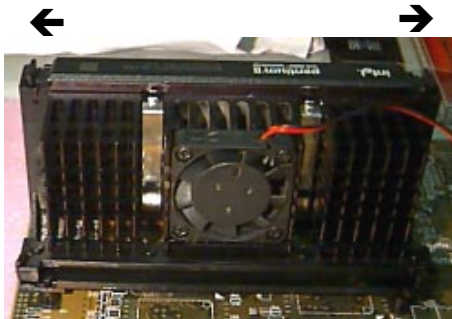

Step 8: Install the Heat Sink Support Top Bar.

Push the Heat Sink Support Top Bar to the Heat Sink Support Base, until you hear a “click” sound. Check for a perfect fit.



**Heatsink
Support Top
Bar**

The installation is now complete.

B. Boxed Pentium® II Processor Installation Procedures

The Boxed Pentium® II Processor has a built-in Fan and Heat Sink. It also has a Heat Sink Support. So if you're going to use a Boxed Pentium™ II Processor, all you need is the Retention Mechanism.

Step 1: Insert the Retention Mechanism Attach Mount at the bottom of the mainboard.

Step 2: Install the Retention Mechanism.

Look for the key on Slot 1, and match it with the Notch Key on the Retention Mechanism for proper direction. Then, attach the Retention Mechanism to the Retention Mechanism Attach Mount. Use a Screwdriver to secure the Retention Mechanism.

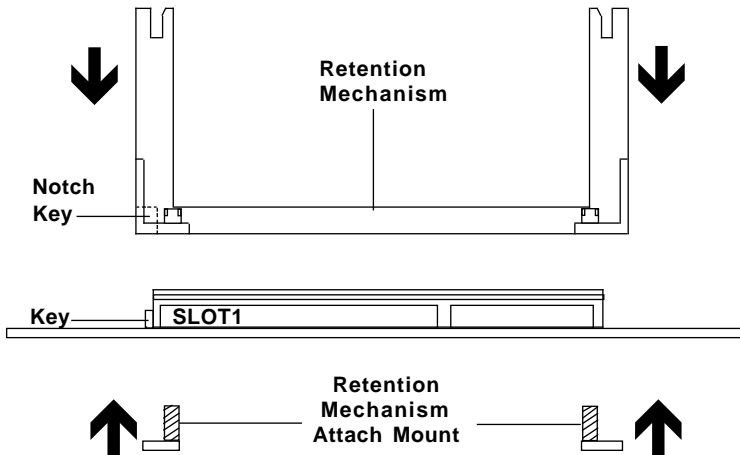

Step 3: Install the Heat Sink Support Base.

Look for the 2 holes across Slot 1, and match it with the 2 Heat Sink Support Base. Take note that one hole/base is bigger than the other.

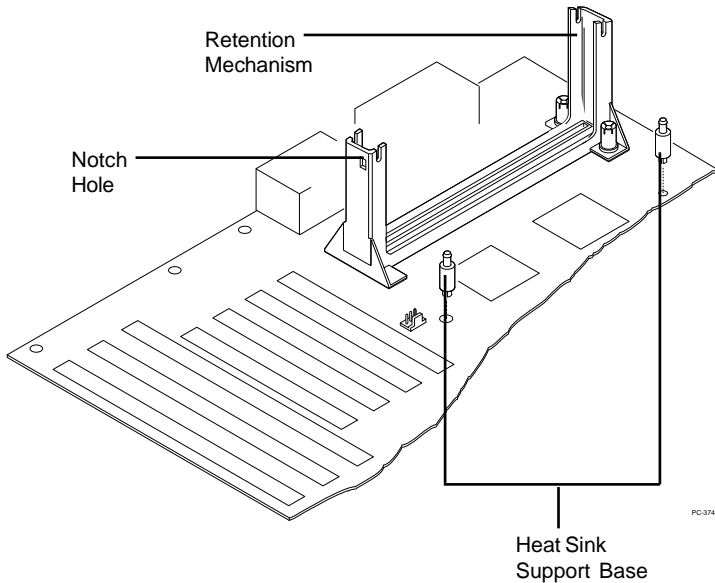

Push the Heat Sink Support Base onto the mainboard, until you hear a click sound. Check for a perfect fit.

Step 4: Install the Heat Sink Support.

Attach the 2 Heat Sink Supports to the sides of the Processor. These Heat Sink Supports will fit in any direction, so be sure that the Heat Sink Support Locks are oriented outwards for the proper direction.

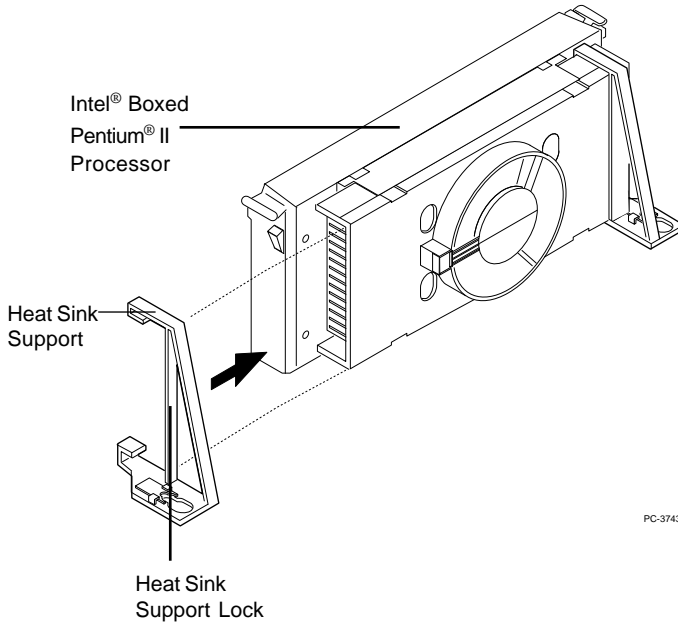

Step 5: Unlock the Processor Locks and Heat Sink Support Locks.

Push in the Processor Locks. Open the Heat Sink Support Locks.

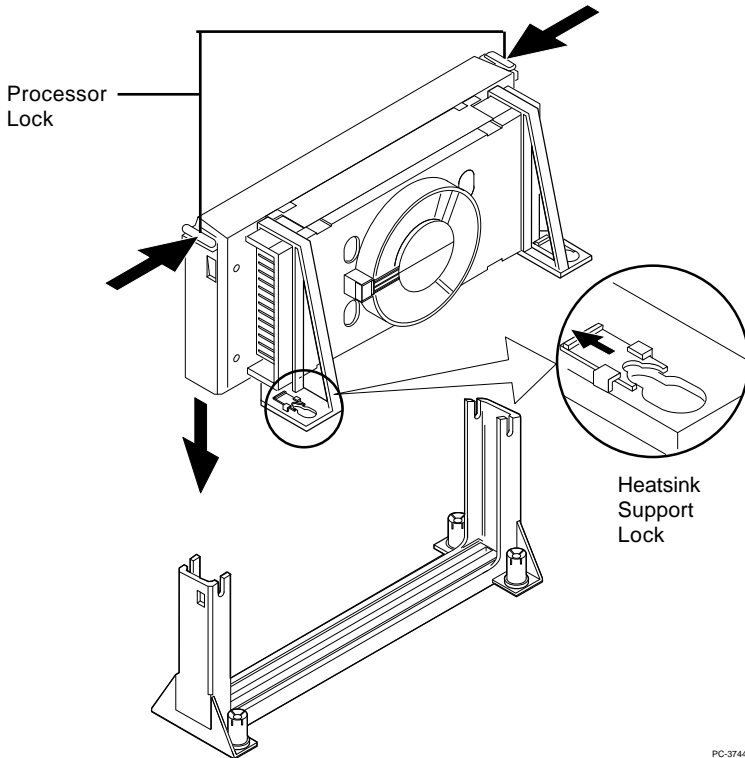

Step 6: Insert the Processor like inserting a PCI or an ISA card.

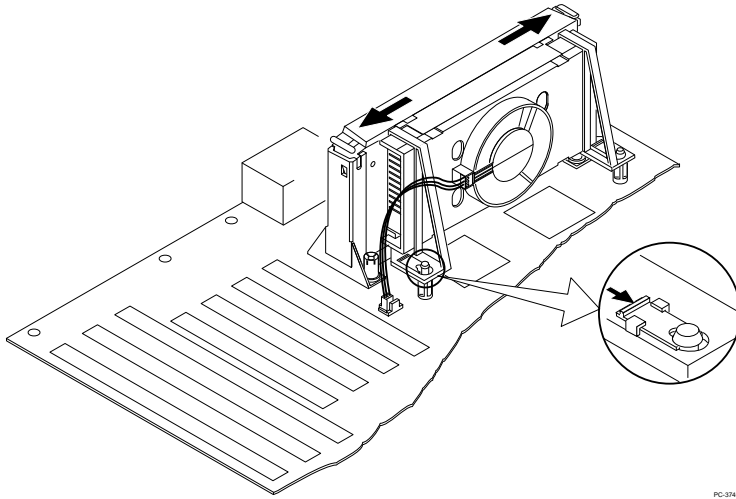
**Step 7: Lock the Processor Locks and Heat Sink Support Locks**

Secure the CPU by pushing out the Processor Locks. Close the Heat Sink Support Locks.

The installation is now complete.

2.1-2 CPU Speed Setting: SW1

To adjust the speed of the CPU, you must know the specification of your CPU (*always ask the vendor for CPU specification*). Then look at **Table 2.1 (200 ~ 333MHz Pentium® II processor)** for proper setting.

CPU Type	SW1
200MHz	1 1 0 1
233MHz	1 0 0 1
266MHz	1 1 1 0
300MHz	1 0 1 0
333MHz	1 1 0 0

1 = ON



0 = OFF

Table 2.1 200 ~ 333MHz Intel® Pentium® II processor

2.1-3 CPU Clock Generator Setting: J10/J9

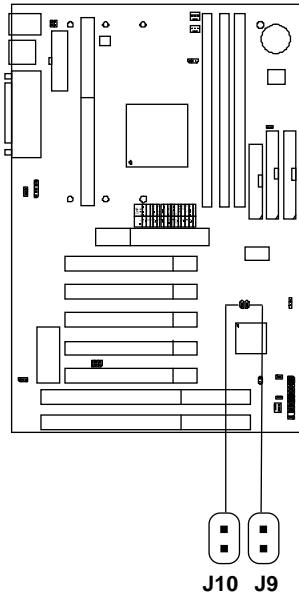
These jumper is used to set the CPU Clock.



CPU Clock	J10 J9
66 MHz	
68 MHz	
75 MHz	

Note: 68/75 MHz CPU clock are both reserved function.

2.1-4 CPU Fan Power Connectors: JFAN/CFAN1/SFAN1/PSFAN1

These connectors support system cooling fan with +12V. It supports three pin head connector. When connecting the wire to the connector, always take note that the red wire is the positive and should be connected to the +12V, the black wire is Ground and should be connected to GND. If your mainboard has LM78 chipset on-board, you must use a specially designed fan with speed sensor to take advantage of LM78’s CPU fan control.

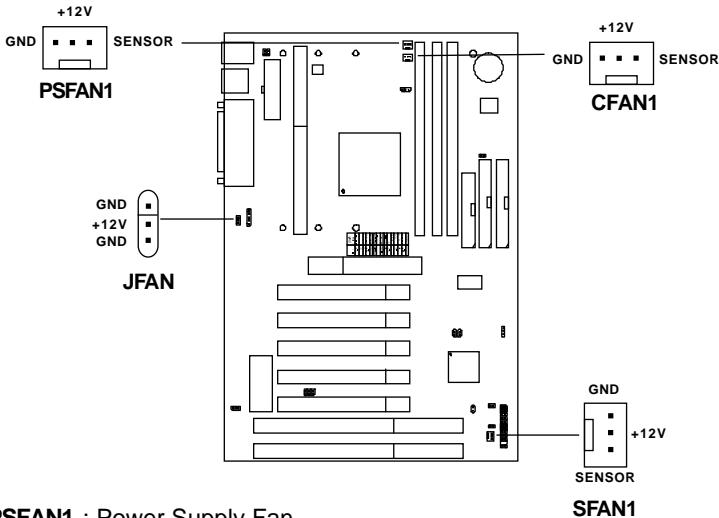

- PSFAN1** : Power Supply Fan
- CFAN1** : CPU Fan
- SFAN1** : System(Chassis) Fan

For fans with fan speed sensor, every rotation of the fan will send out 2 pulses. LM78 will count and report the fan rotation speed.

- Note:**
1. **CFAN1/SFAN1/PSFAN1** are the CPU, Power and Chassis Cooling Fan Speed Connector (reserved for LM78 System Hardware Monitor Option.)
 2. Always consult vendor for proper CPU cooling fan.

2.2 Flash ROM Programming Voltage: JMODE1

This jumper is for setting the Voltage of the Flash ROM BIOS.

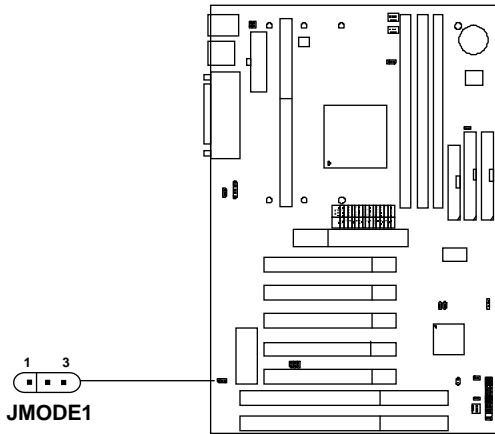

Voltage Setting

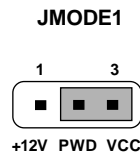
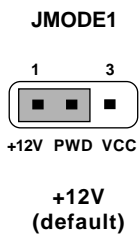

Note: Short 1-2 pin, if you're using Intel® or flash memory and you want to flash the ROM data.

2.3 External Battery Connector: JBAT1

A battery must be used to retain the mainboard configuration in CMOS RAM. If you use the on-board battery, you must short 1-2 pins of JBAT1 to keep the CMOS data.

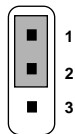
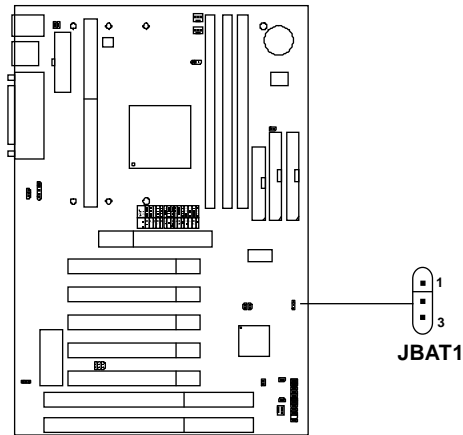

Keep Data

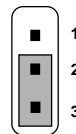

Clear Data

Note: You can clear CMOS by shorting 2-3 pin, while the system is off. Then, return to 1-2 pin position. Avoid clearing the CMOS while the system is on; it will damage the mainboard.

2.4 Memory Installation

2.4-1 Memory Bank Configuration

The mainboard supports a maximum of 1 GB of memory for EDO and 512MB for SDRAM: It provides three 168-pin **unbuffered** DIMMs (Double In-Line Memory Module) sockets. It supports 8 MB to 256 Mbytes DIMM memory module. The memory module can be either SDRAM or EDO (Extended Data Output) Mode DRAM. A DIMM consists of two Banks and may have a maximum of 256 MB of memory.

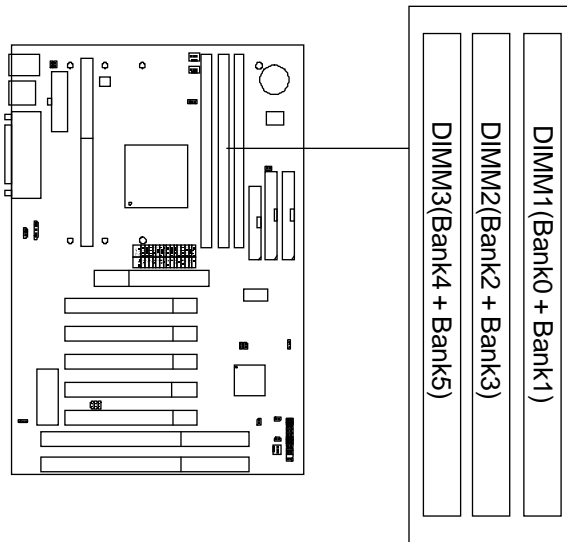

Note: FP(Fast Page) & BEDO(Burst EDO) are not supported.

2.4-2 Memory Installation Procedures

A. How to install a DIMM Module

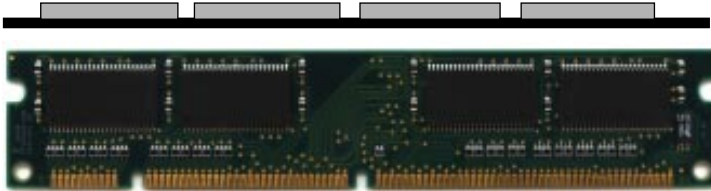

Single Sided DIMM

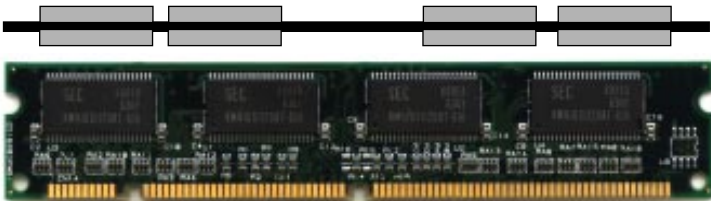

Double Sided DIMM

1. The DIMM slot has a two Notch Key “VOLT and DRAM”, so the DIMM memory module can only fit in one direction.
2. Insert the DIMM memory module vertically into the DIMM slot. Then push it in.

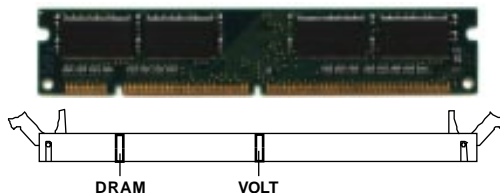

3. Close the plastic clip at the side of the DIMM slot.

Note: You can only use a 3.3 volt DIMM module (EDO or SDRAM).

2.4-1 Memory Population Rules

1. Supports EDO and SDRAM.
2. Supports **unbuffered** DIMM.
3. To operate properly, at least one 168-pin DIMM module must be installed.
4. This mainboard supports Table Free memory, so memory can be installed on DIMM1, DIMM2, or DIMM 3 in any order.
5. Supports 3.3 volt DIMM.
6. The DRAM addressing and the size supported by the mainboard is shown next page.

Table 2.4-1 EDO DRAM Memory Addressing

DRAM Tech.	DRAM Density & Width	DRAM Addressing	Address Size		MB/SIMM	
			Row	Column	Single no. Side(S) pcs.	Double no. Side(D) pcs.
4M	1Mx4	SYMM	10	10	4MBx8	8MBx16
16M	1Mx16	SYMM	10	10	4MBx2	8MBx4
	1Mx16	ASYM	12	8	4MBx2	8MBx4
	2Mx8	ASYM	11	10	8MBx4	16MBx8
	2Mx8	ASYM	12	9	8MBx4	16MBx8
	4Mx4	SYMM	11	11	16MBx8	32MBx16
	4Mx4	ASYM	12	10	16MBx8	32MBx16
64M	2Mx32	ASYM	11	10	8MBx1	16MBx2
	2Mx32	ASYM	12	9	8MBx1	16MBx2
	2Mx32	ASYM	13	8	8MBx1	16MBx2
	4Mx16	SYMM	11	11	16MBx2	32MBx4
	4Mx16	ASYM	12	10	16MBx2	32MBx4
	8Mx8	ASYM	12	11	32MBx4	64MBx8
	16Mx4	SYMM	12	12	64MBx8	128MBx16

Table 2.4-2 SDRAM Memory Addressing

DRAM Tech.	DRAM Density & Width	DRAM Addressing	Address Size		MB/DIMM	
			Row	Column	Single no. Side(S) pcs.	Double no. Side(D) pcs.
16M	1Mx16	ASYM	11	8	8MBx4	16MBx8
	2Mx8	ASYM	11	9	16MBx8	32MBx16
	4Mx4	ASYM	11	10	32MB	64MB
64M	2Mx32	ASYM	11	9	32MBx2	64MBx4
	2Mx32	ASYM	12	8	16MBx2	32MBx4
	4Mx16	ASYM	11	10	32MB	64MB
	4Mx16	ASYM	13	8	32MB	64MB
	8Mx8	ASYM	13	9	64MB	128MB
	16Mx4	ASYM	13	10	128MB	256MB
64M	2Mx32	ASYM	11	8		
	4Mx16	ASYM	12	8		
	8Mx8	ASYM	12	9		
	16Mx4	ASYM	12	10		

2.5 Case Connector: JFP1

The Turbo LED, Reset Switch, Key Lock, Power LED, Speaker and HDD LED are all connected to the JFP1 connector block.

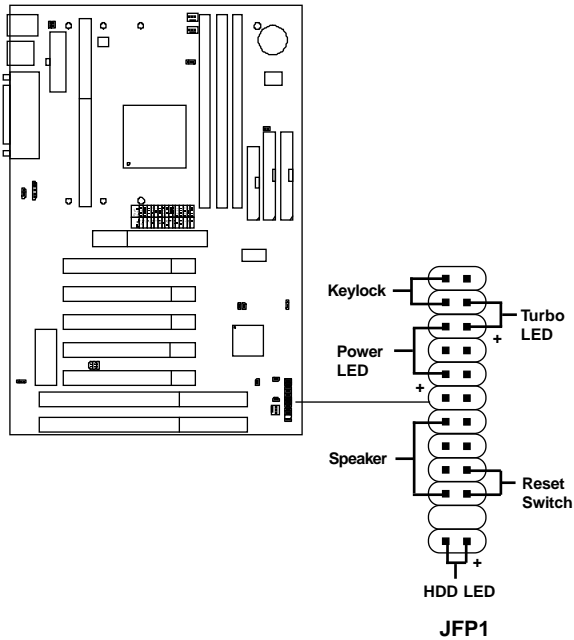

2.5-1 Turbo LED

The Turbo LED is always ON. You can connect the Turbo LED from the system case to this pin.

2.5-2 Reset Switch

Reset switch is used to reboot the system rather than turning the power ON/OFF. Avoid rebooting while the HDD LED is lit. You can connect the Reset switch from the system case to this pin.

2.5-3 Keylock

Keylock allows you to disable the keyboard for security purposes. You can connect the keylock to this pin.

2.5-4 Power LED

The Power LED is always lit while the system power is on. You can connect the Power LED from the system case to this pin.

2.5-5 Speaker

Speaker from the system case is connected to this pin.

2.5-6 HDD LED

HDD LED shows the activity of a hard disk drive. Avoid turning the power off while the HDD led is lit. You can connect the HDD LED from the system case to this pin.

2.6 Floppy Disk Connector: FDC

The mainboard also provides a standard floppy disk connector FDC that supports 360K, 720K, 1.2M, 1.44M and 2.88M floppy disk types. This connector support the provided floppy drive ribbon cables.

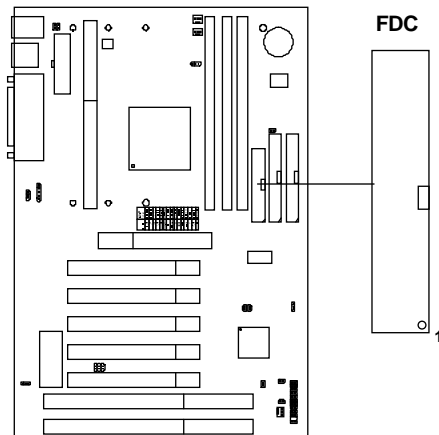

2.7 Hard Disk Connectors: IDE1 & IDE2

The mainboard has a 32-bit Enhanced PCI IDE Controller that provides PIO mode 0~4, Bus Master, and Ultra DMA/33 function. It has two HDD connectors IDE1 (primary) and IDE2 (secondary). You can connect up to four hard disk drives, CD-ROM, 120MB Floppy (reserved for future BIOS) and other devices to IDE1 and IDE2. These connectors support the provided IDE hard disk cable.

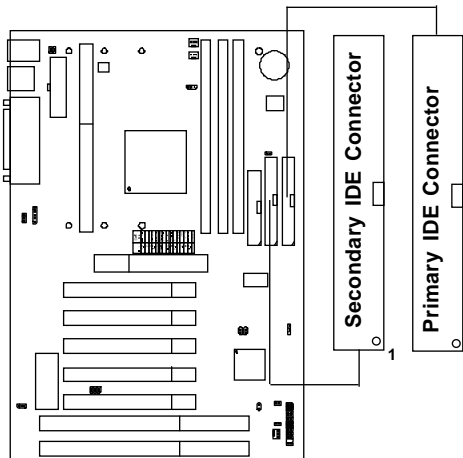

IDE1(Primary IDE Connector)

The first hard drive should always be connected to IDE1. IDE1 can connect a Master and a Slave drive. You must configure second hard drive to Slave mode by setting the jumper accordingly.

IDE2(Secondary IDE Connector)

IDE2 can also connect a Master and a Slave drive.

2.8 Power Supply

2.8-1 ATX 20-pin Power Connector: JPWR1

This connector supports the power button on-board. Using the ATX power supply, functions such as Modem Ring Wake-Up and Soft Power Off are supported by this mainboard. This power connector supports instant power on function which means that system will boot up instantly when the power connector is inserted on the board.

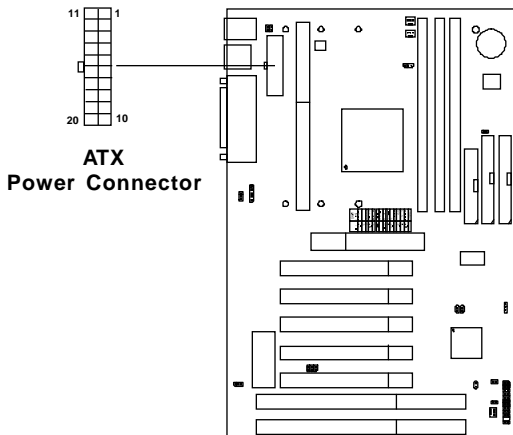

PIN DEFINITION

PIN	SIGNAL	PIN	SIGNAL
1	3.3V	11	3.3V
2	3.3V	12	-12V
3	GND	13	GND
4	5V	14	PS_ON
5	GND	15	GND
6	5V	16	GND
7	GND	17	GND
8	PW_OK	18	-5V
9	5V_SB	19	5V
10	12V	20	5V

Warning: Since the mainboard has the instant power on function, make sure that all components are installed properly before inserting the power connector to ensure that no damage will be done.

2.8-2 Remote Power On/Off Switches: JSW1/JSW2

Connect to a 2-pin push button switch. During OFF state, press once and the system turns on. **During ON stage, push once and the system goes to sleep mode: pushing it more than 4 seconds will change its status from ON to OFF.** If you want to change the setup, you could go to the BIOS Power Management Setup. This is only used for ATX type power supply.

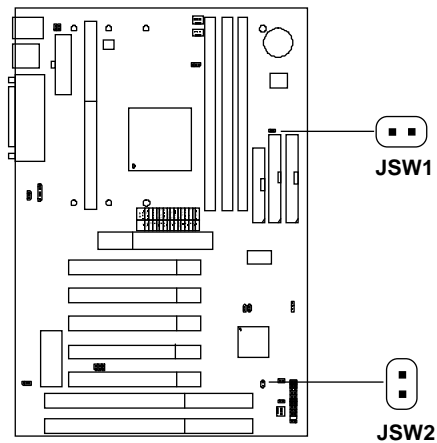

Note: The two switches are provided by the mainboard for your convenience, so you can use any of them. The two switches have the same feature.

2.9 IrDA Infrared Module Connector: IR1

The mainboard provides one 5-pin infrared (IR) connector for IR modules. This connector is for optional wireless transmitting and receiving infrared module. You must configure the setting through the BIOS setup to use the IR function. FIR and Consumer IR are reserved functions.

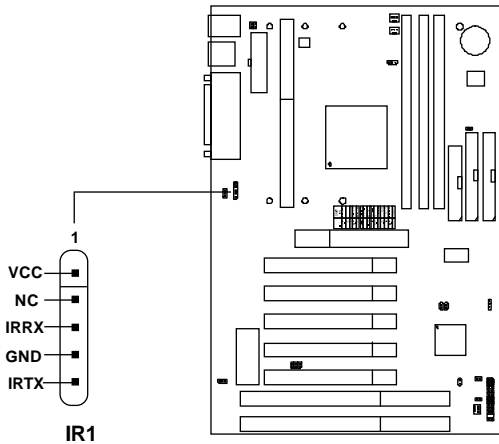

2.10 Serial Port Connectors: COM A & COM B

The mainboard has two 9-pin male DIN connectors for serial ports COM A and COM B. These two ports are 16550A high speed communication ports that send/receive 16 bytes FIFOs. You can attach a mouse or a modem cable directly into these connectors.

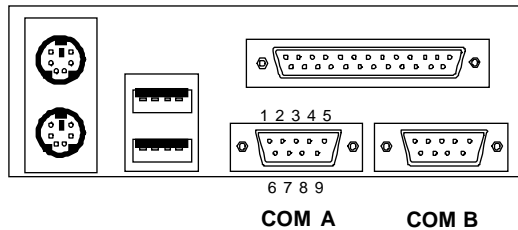

PIN DEFINITION

PIN	SIGNAL
1	DCD (Data Carry Detect)
2	SIN (Serial In or Receive Data)
3	SOUT (Serial Out or Transmit Data)
4	DTR (Data Terminal Ready)
5	GND
6	DSR (Data Set Ready)
7	RTS (Request To Send)
8	CTS (Clear To Send)
9	RI (Ring Indicate)

2.11 Parallel Port Connector: LPT

The mainboard provides a 25 pin female centronic connector for LPT. A parallel port is a standard printer port that also supports Enhanced Parallel Port(EPP) and Extended capabilities Parallel Port(ECP). See connector and pin definition below:

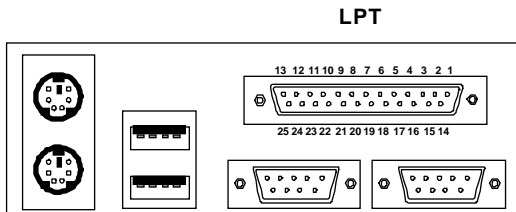

PIN DEFINITION

PIN	SIGNAL	PIN	SIGNAL
1	STROBE	14	AUTO FEED#
2	DATA0	15	ERR#
3	DATA1	16	INIT#
4	DATA2	17	SLIN#
5	DATA3	18	GND
6	DATA4	19	GND
7	DATA5	20	GND
8	DATA6	21	GND
9	DATA7	22	GND
10	ACK#	23	GND
11	BUSY	24	GND
12	PE	25	GND
13	SELECT		

2.12 Mouse Connector: JKBMS1

The mainboard provides a standard PS/2[®] mouse mini DIN connector for attaching a PS/2[®] mouse. You can plug a PS/2[®] mouse directly into this connector. The connector location and pin definition are shown below:

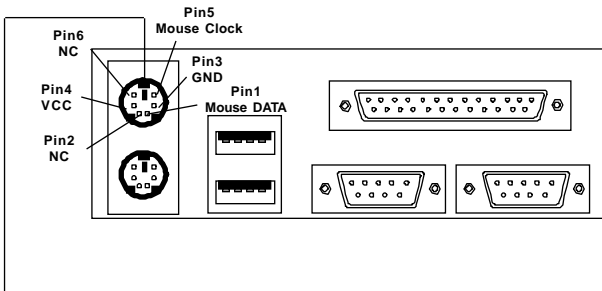

PS/2 Mouse (6-pin Female)

2.13 Keyboard Connector: JKBMS1

The mainboard provides a standard PS/2[®] keyboard mini DIN connector for attaching a keyboard. You can plug a keyboard cable directly into this connector.

PS/2 Keyboard (6-pin Female)

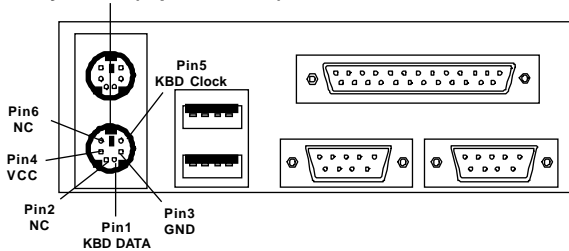

2.14 USB Connector: USB

The mainboard provides a **UHCI(Universal Host Controller Interface) Universal Serial Bus root** for attaching USB devices like: keyboard, mouse and other USB devices. You can plug the USB device directly to this connector.

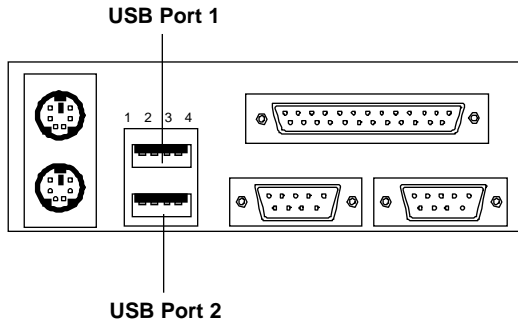

PIN	SIGNAL
1	VCC
2	-Data0
3	GND
4	+Data0

2.15 Power Saving Switch Connector: JGS

Attach a power saving switch to **JGS**. When the switch is pressed, the system immediately goes into suspend mode. Press any key and the system wakes up.

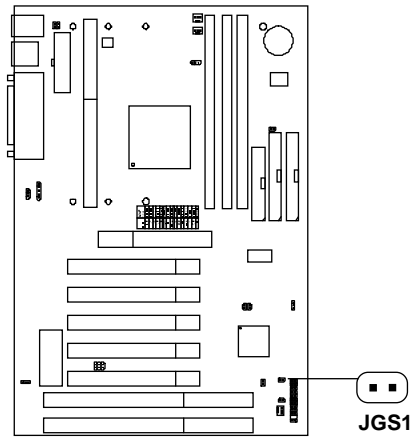

2.16 Power Saving LED Connector: JGL1

JGL1 can be connected with LED. This will lit while the system is in suspend mode.

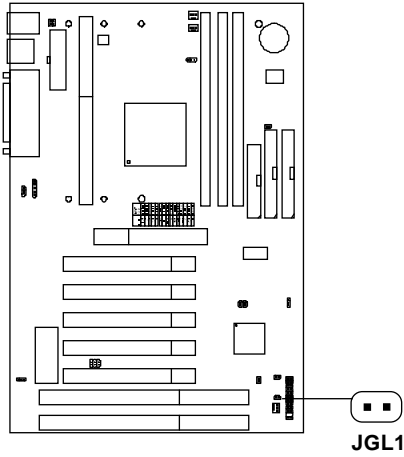

2.17 Keyboard Power: J7, J8

The J7 and J8 jumpers are for setting keyboard power.

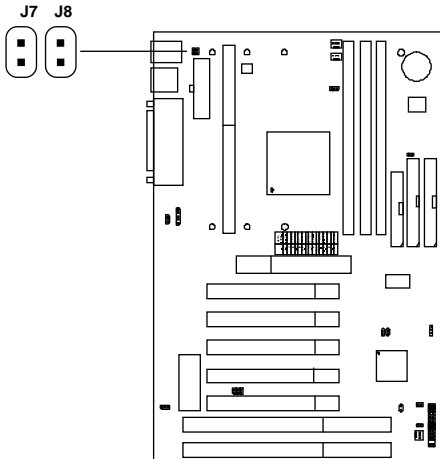

Power Setting



5V
(default)



5V_Standby

Chapter 3

AMI® BIOS USER GUIDE

The system configuration information and chipset register information is stored in the CMOS RAM. This information is retained by a battery when the power is off. Enter the BIOS setup (if needed) to modify this information.

The following pages will describe how to enter BIOS setup, and all about options.

3.1 Enter BIOS Setup

Enter the AMI® setup Program's Main Menu as follows:

1. Turn on or reboot the system. The following screen appears with a series of diagnostic check.

```
AMIBIOS (C) 1996 American Megatrends Inc.  
AGIOMS VXXX XXXXXX
```

```
Hit <DEL> if you want to run setup
```

```
(C) American Megatrends Inc.  
61-XXXX-001169-00111111-071592-i82440FX-H
```

2. When the "Hit " message appears, press key to enter the BIOS setup screen.
3. After pressing key, the BIOS setup screen will appear.

Note: *If you don't want to modify CMOS original setting, then don't press any key during the system boot.*

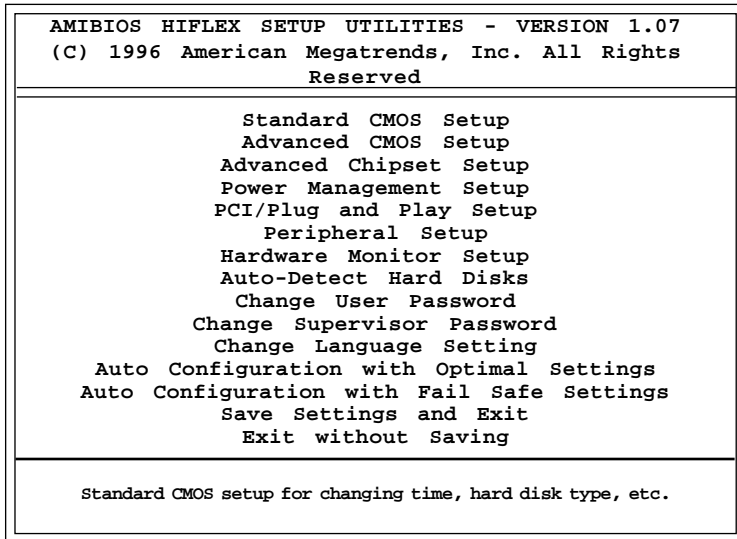

4. Use the <Up> and <Down> key to move the highlight scroll up or down.
5. Use the <ENTER> key to select the option.
6. To exit, press <ESC>. To save and exit, press <F10>.
7. Section 3.2 to 3.7 will explain the option in more details.

3.2 Standard CMOS Setup

1. Press <ENTER> on "Standard CMOS Setup" of the main menu screen .

```

AMIBIOS SETUP - STANDARD CMOS SETUP
(C)1996 American Megatrends, Inc. All Rights Reserved

```

```

Date (mm/dd/yyyy): Mon Jul 28, 1997
Time (hh/mm/ss): 17:09:25

Floppy Drive A: 1.44 MB 3 1/2
Floppy Drive B: Not Installed

```

	Type	Size	Cyln	Head	WPcom	Sec	LBA Mode	Blk Mode	PIO Mode	32Bit Mode
Pri Master	:Auto						ON	ON	AUTO	ON
Pri Slave	:Auto						ON	ON	AUTO	ON
Sec Master	:Auto						ON	ON	AUTO	ON
Sec Slave	:Auto						ON	ON	AUTO	ON

```

Boot Sector Virus Protection Disabled

```

```

Month : Jan-Dec          ESC:Exit :Sel
Day   : 01-31           PgUp/PgDn:Modify
Year  : 1901-2099      F2/F3:Color

```

2. Use <Up> and <Down> to choose the item and <PgUp> and <PgDn> keys to modify the highlighted item.
3. After you have finished with the Standard CMOS Setup, press <ESC> to go back to the main menu.

3.3 Advanced CMOS Setup

1. Press <ENTER> on “Advanced CMOS Setup” of the main menu

AMIBIOS SETUP - ADVANCED CMOS SETUP		
(C) 1996 American Megatrends, Inc. All Rights Reserved		
Quick Boot	Enabled	Available Options: Enabled Disabled
1st Boot Device	Floppy	
2nd Boot Device	IDE 0	
3rd Boot Device	CD-ROM	
Try Other Boot Devices	Yes	
Initial Display Mode	BIOS	
Display Mode At ADD-ON ROM Init	Force BIOS	
Floppy Access Control	Read-Write	
Hard Disk Access Control	Read-Write	
BootUp Num-Lock	On	
Floppy Drive Swap	Disabled	
Floppy Drive Seek	Disabled	
PS/2 Mouse Support	Enabled	
Primary Display	Abset	
Password Check	Setup	
Parity Check	Disabled	
Boot to OS/2 64M	No	
System BIOS Cacheable	Enabled	
C000, 16k Shadow	Cached	
C400, 16k Shadow	Cached	
C800, 16k Shadow	Disabled	
CC00, 16k Shadow	Disabled	
D000, 16k Shadow	Disabled	ESC:Exit :Sel
D400, 16k Shadow	Disabled	PgUp/PgDn:Modify
D800, 16k Shadow	Disabled	F2/F3:Color
DC00, 16k Shadow	Disabled	

2. Use <Up> and <Down> to choose the item and <PgUp> and <PgDn> keys to modify the highlighted item.
3. After you have finished with the Advanced CMOS Setup, press <ESC> to go back to the main menu.

Description of the item on screen follows:**Quick Boot**

Set this option to Enabled to permit AMI® BIOS to boot within 5 seconds. This option replaces the old ABOVE 1 MB Memory Test option. The Optimal default setting is Enabled. The Fail-Safe default setting is Disabled.

1st Boot Device/2nd Boot Device/3rd Boot Device

This option sets the sequence of boot drives.

The settings are:

IDE0	The system will boot from the first HDD.
IDE1	The system will boot from the Second HDD.
IDE2	The system will boot from the Third HDD.
IDE3	The system will boot from the Fourth HDD.
F(optical)	The system will boot from LS-120(120M Floppy).
SCSI	The system will boot from the SCSI.
Network	The system will boot from the Network drive.
CD-ROM	The system will boot from the CD-ROM.
Disable	Disable this sequence.

Try other Boot Devices

This option sets the device boot, if all the Four Boot Devices failed.

Floppy Access Control

This option sets the Floppy to Read-only or Read-Write.

HDD Access Control

This option sets the HDD to Read-only or Read-Write. During Read-only, if you try to write on the HDD, the system will halt.

Boot up Num Lock

When this option is set to Off, AMI® BIOS turns off the Num Lock key when the system is powered on. The end user can then use the arrow keys on both the numeric keypad and the keyboard. The settings are On or Off. The optimal default and Fail-Safe default settings are On.

Floppy Drive Swap

Set this option to Enabled to specify that floppy drives A: and B: are swapped. The setting are Enabled and Disabled. The Optimal and Fail-Safe default settings are Disabled.

Floppy Drive Seek

When this option is set to Enabled, AMI® BIOS performs a Seek command on floppy drive A: before booting the system. The settings are Enabled and Disabled. The Optimal and Fail-Safe default settings are Disabled.

PS/2® Mouse Support

When this option is set to Enabled, AMI® BIOS supports a PS/2® mouse. The settings are Enabled and Disabled. The Optimal and Fail-Safe default settings are Enabled.

Primary Display

This option configures the primary display subsystem in the computer. The settings are Mono(monochrome), 40CGA, 80CGA or VGA/EGA. The optimal and Fail-Safe default settings are VGA/EGA.

Password Check

This option specifies the type of AMI® BIOS password protection that is implemented. The Optimal and Fail-Safe default settings are Setup.

Parity Check

Set this option to Enabled to use the Parity Check function. The DIMM module need to have parity bit for this function to work.

Boot to OS/2®

Set this option to Enabled to permit the BIOS to run properly, if OS/2® is to be used with > 64MB of DRAM. The settings are Enabled or Disabled. The Optimal and Fail-safe default settings are Disabled.

Internal Cache/External Cache

This option selects the type of caching algorithm used by AMI® BIOS and the CPU for L1 cache memory(internal/external to the CPU). The settings are Writeback - a writeback algorithm is used, Write-through - a write-through algorithm is used or Disabled - AMI® BIOS does not specify the type of caching algorithm. The algorithm is set by the CPU. The Optimal and Fail-Safe default settings are Writeback.

System BIOS Cacheable

AMI® BIOS always copies the system BIOS from ROM to RAM for faster execution. Set this option to Enabled to permit the contents of the F0000h RAM memory segment to be written to and read from cache memory. The settings are Enabled or Disabled. The Optimal default setting is Enabled. The Fail-Safe default setting is Disabled.

C000, 16K Shadow/C400, 16k Shadow

These options specify how the contents of the video ROM are handled. The settings are:

Disabled - the Video ROM is not copied to RAM.

Cached - the contents of the video ROM from C0000h - C7FFFh are not only copied from ROM to RAM; it can also be written to or read from cache memory.

Shadow - the Contents of the video ROM from C0000h - C7FFFh are copied(shadowed) from ROM to RAM for faster execution.

The Optimal and Fail-Safe default setting is Cached.

C800, 16k Shadow/CC00, 16k Shadow/D000, 16K Shadow/D400, 16k Shadow/D800, 16k Shadow/DC00, 16K Shadow

These options specify how the contents of the adaptor ROM named in the option title are handled. The ROM area that is not used by ISA adapter cards will be allocated to PCI adapter cards. The settings are;

Disabled - The specified ROM is not copied to RAM.

Cache - The contents of the ROM area are not only copied from ROM to RAM for faster execution, it can also be written to or read from cache memory.

Shadow - The contents of the ROM area are copied from ROM to RAM for faster execution.

The Optimal and Fail-Safe default settings are Disabled.

3.4 Advanced Chipset Setup

1. Press <ENTER> on “Advanced Chipset Setup” of the main menu screen.

AMIBIOS SETUP - ADVANCED CHIPSET SETUP		
(C) 1996 American Megatrends, Inc. All Rights Reserved		
Auto Configure EDO DRAM Timing	Enabled	Available Options:
EDO DRAM Speed (ns)	60	Enabled
EDO Read Burst Timing	x222	Disabled
EDO Write Burst Timing	x222	
EDO RAS Precharge Timing	3 clocks	
EDO RAS to CAS Delay	3 clocks	
MA wait State	slow	
***** SDRAM Timing *****		
SDRAM RAS to CAS Delay	2 Clks	
SDRAM CAS Latency	3 Clks	
SDRAM RAS Precharge Time	2 Clks	
DRAM Integrity Mode	Non ECC	
VGA Frame Buffer USWC	Disabled	
PCI Frame Buffer USWC	Disabled	
Fixed Memory Hole	Disabled	
CPU To PCI IDE Posting	Enabled	
USWC Write I/O Post	Disabled	
AGP Aperture Size	64 MB	
USB Passive Release	Enabled	
PIIX4 Passive Release	Enabled	
PIIX4 Delayed Transaction	Enabled	
USB Function	Enabled	
USB Keyboard Legacy Support	Disabled	
		ESC:Exit :Sel
		PgUp/PgDn:Modify
		F2/F3:Color

2. Use <Up> and <Down> to choose the item and <PgUp> and <PgDn> keys to modify the highlighted item.
3. After you have finished with the Advanced Chipset Setup, press <ESC> to go back to the main menu.

Description of the item on screen follows:**Auto Configure EDO DRAM Timing**

Choose Enabled(default) will automatically configure the DRAM timing depending on the “DRAM Speed” selection. Choose disable to customize setup.

EDO DRAM Speed (ns)

This option specifies the RAS access time (in nanoseconds) for the DRAM used in the computer. The settings are 50,60 or 70. The Optimal default setting is 60 and the Fail-Safe default setting is 70.

EDO DRAM Read Burst Timing

Choose DRAM read burst timing for the customize setup. B stand for BEDO DRAM, E stand for EDO DRAM and F stand for FAST PAGE DRAM.

EDO DRAM Write Burst Timing

Choose DRAM write burst timing for the customize setup.

EDO RAS Precharge Timing

This option defines the RAS# precharge requirements for the EDO memory type in 66MHz clocks.

EDO RAS to CAS Delay

This operation decide the delay in assertion of CAS#(SCAS#) from assertion of RAS#(SRAS#) in 66MHz.

MA Wait State

This option selects Fast or Slow MA bus timing. The Slow timing is equal to Fast+1, in term of clock number for EDO DRAM.

SDRAM RAS to CAS Delay

This operation decide the delay in assertion of CAS#(SCAS#) from assertion of RAS#(SRAS#) in 66MHz.

SDRAM CAS Latency

This option determines the CAS latency time parameter of SDRAM. The settings are 2 clks or 3 clks.

SDRAM RAS Precharge Time

This option defines the RAS# precharge requirements for the SDRAM memory type in 66MHz clocks.

DRAM Integrity Mode

During ECC, this will enable the DRAM ECC mechanism that allows detection of single-bit and multiple-bit errors and recovery of single-bit errors. During EC, the ECC logic will calculate 8-bit pattern written along with 64-bit data into the main memory. During Read operation, 8-bit ECC code is read along with 64-bit data and error checking is performed. No correction of data will take place in this operation mode. During Disabled, this will disable the ECC mechanism.

Note: If you choose ECC or EC modes, you must use a DIMM with ECC byte.

VGA Frame Buffer USWC

The Pentium® II processor supports the Uncacheable Speculatable Write-Combining (USWC) memory type. The processor provides a write-combining with buffering strategy for write operation. This is useful for frame buffering. Writing to USWC memory can be buffered and combined in the processors write-combining buffer (WCB). The WCBs are viewed as a special purpose outgoing write buffers, rather than a cache. The WCBs are written into memory to allocate a different address, or after executing a serializing, locked, or I/O instructions.

During Enabled, this will enable the processor memory location A000 and B000 segment as USWC memory type.

PCI Frame Buffer USWC

The Pentium® II processor supports the Uncacheable Speculatable Write-Combining (USWC) memory type. The processor provides a write-combining with buffering strategy for write operation. This is useful for frame buffering. Writing to USWC memory can be buffered and combined in the processors write-combining buffer (WCB). The WCBs are viewed as a special purpose outgoing write buffers, rather than a cache. The WCBs are written into memory to allocate a different address, or after executing a serializing, locked, or I/O instructions.

During Enabled, this will enable the processor memory location C000 and DFFF segment as USWC memory type.

DRAM Refresh Queue

Choose Enabled, the system will provide 4-deep refresh queue. All refresh request are queued, with the 4th refresh request being the priority request. All refresh requests are priority when the refresh queue is Disabled.

Fixed Memory Hole

This option allows the end user to specify the location of a memory hole. The cycle matching the selected memory hole will be passed to the ISA bus. If Enabled, the selected hole is not remapped.

CPU To PCI IDE Posting

Set this option to Enabled to enable posted messages from the CPU to the PCI bus or IDE controller. The settings are Enabled or Disabled. The Optimal and Fail-Safe default settings are Enabled.

USWC Write I/O Post

Set this option to Enabled to use USWC(Uncacheable, Speculatable, Write-Combined) memory. The settings are Enabled or Disabled. The Optimal and Fail-Safe default settings are Disabled.

AGP Aperture Size

This option determines the effective size of the graphics aperture used in the particular PAC configuration. The AGP aperture is memory-mapped, while graphics data structure can reside in a graphics aperture. The aperture range should be programmed as not cacheable in the processor cache, accesses with the aperture range are forwarded to the main memory, then PAC will translate the original issued address via a translation table that is maintained on the main memory. The option allows the selection of an aperture size of 4MB, 8MB, 16MB, 32MB, 64MB, 128MB, and 256MB.

USB Passive Release

During Enabled, this will allow the PIIX4® to use passive release(look at PIIX4® Passive Release) while transferring control information or data for USB transaction. During Disabled, PIIX4® will perform PCI accesses for USB without using passive release.

PIIX4® Passive Release

The PIIX4® ISA bridge support GAT (Guaranteed Access Time) mode, which will now violate the spirit of the PCI specification. The systems provides a programmable passive release mechanism to meet the required master latencies. During Enabled, ISA masters may see long delays in accessing PCI memory, including the main DRAM array. The ISA GAT mode is also not supported during enable. ISA masters must honor IOCHRDY.

PIIX4® Delayed Transaction

During Enabled, the PIIX4® delay transaction mechanism is enabled when the PIIX4® is the target of a PCI transaction. A read cycle from Host to PCI is immediately retrived due to any pending PCI to DRAM cycle. During Disabled, a read cycle from Host to PCI is waited until time-out due to any pending PCI to DRAM cycle.

USB Function

Set this option to Enabled or Disabled the on-chip USB controller.
The Optional and Fail-Safe default settings are Disabled.

USB Keyboard Legacy Support

Set this option to Enabled or Disabled USB keyboard/mouse.
The Optional and Fail-Safe default settings are Disabled.

3.5 Power Management Setup

1. Press <ENTER> on "Power Management Setup" of the main menu screen.

AMIBIOS SETUP - POWER MANAGEMENT SETUP		
(C) 1996 American Megatrends, Inc. All Rights Reserved		
Power Management / APM	Disabled	Available Options:
Green PC Monitor Power State	Stand By	Enabled
Video Power Down Mode	Suspend	Disabled
Hard Disk Power Down Mode	Stand By	
Standby Time Out	1	
Suspend Time Out	1	
Throttle Slow Clock Ratio	50-62.5%	
Modem Use IO Port	N/A	
Modem Use IRQ	N/A	
Display Activity	Ignore	
Device 6(Serial Port 1)	Monitor	
Device 7(Serial Port 2)	Monitor	
Device 8(Parallel Port)	Ignore	
Device 5(Floppy Disk)	Monitor	
Device 0(Primary master IDE)	Monitor	
Device 1(Primary slave IDE)	Ignore	
Device 2(Secondary master IDE)	Monitor	
Device 3(Secondary slave IDE)	Ignore	
System Thermal	Ignore	
Thermal Slow Clock Ratio	50-62.5%	
CPU Critical Temperature	40°c/104°f	
Power Button Function	Suspend	ESC:Exit :Sel
Ring Resume From Soft-Off	Disabled	PgUp/PgDn:Modify
RTC Alarm Resume From Soft-Off	Disabled	F2/F3:Color

RTC Alarm Date	15
RTC Alarm Hour	12
RTC Alarm Minute	50
RTC Alarm Second	30

2. Use <Up> and <Down> to choose the item and <PgUp> and <PgDn> keys to modify the highlighted item.
3. After you have finished with the Power Management Setup, press <ESC> to go back to the main menu.

Description of the item on screen follows:**Power Management/APM**

Set this option to Enabled to enable the Intel® 82440LX ISA power management features and APM(Advanced Power Management). The settings are Enabled, Inst-On(instant-on) or Disabled. The Optimal and Fail-Safe default settings are Disabled.

Green PC Monitor Power State

This option specifies the power state that the green PC-compliant video monitor enters when AMI® BIOS places it in a power savings state after the specified period of display inactivity has expired. The settings are Off, Standby, Suspend or Disabled. The Optimal and Fail-Safe default settings are Standby.

Video Power Down Mode

This option specifies the power conserving state that the VESA VGA video subsystem enters after the specified period of display inactivity has expired. The settings are Disabled, Standby or Suspend. The Optimal and Fail-Safe default settings are Standby.

Hard Disk Power Down Mode

This option specifies the power conserving state that the hard disk drive enters after the specified period of hard drive inactivity has expired. The settings are Disabled, Standby or Suspend. The Optimal and Fail-Safe default settings are Disabled.

Standby Time Out

This option specifies the length of a period of system inactivity while in Full power on state. When this length of time expires, the computer enters Standby power state. The settings are Disabled, 1 min, 2 min, 3 min, 4 min, 5 min, 6 min, 7 min, 8 min, 9 min, 10 min, 11 min, 12 min, 13 min, 14 min or 15 min. The Optimal and Fail-Safe default settings are Disabled.

Suspend Time Out

This option specifies the length of a period of system inactivity while in Standby state. When this length of time expires, the computer enters Suspend power state. The settings are Disabled, 1 min, 2 min, 3 min, 4 min, 5 min, 6 min, 7 min, 8 min, 9 min, 10 min, 11 min, 12 min, 13 min, 14 min or 15 min. The Optimal and Fail-Safe default settings are Disabled.

Throttle Slow Clock Ratio

This option specifies the speed at which the system clock runs in power saving states. The settings are expressed as a ratio between the normal CPU clock speed and the CPU clock speed when the computer is in the power-conserving state.

Modem Use IO Port

This indicates which IO port will be used by the Modem(if there is a Modem).

Modem Use IRQ

This indicates which IRQ no. will be used by the Modem(if there is a Modem).

Display Activity/Device 6/Device 7/Device 8/Device 5/Device 0/Device 1/Device 1/Device 2/Device 3/System Thermal

When set to Monitor, these options enable event monitoring on the specified hardware interrupt request line. If set to Monitor and the computer is in a power saving state, AMI® BIOS watches for activity on the specified IRQ line. The computer enters the full on power state if any activity occurs.

AMI® BIOS reloads the Standby and Suspend timeout timers if activity occurs on the specified IRQ line.

Power Button Function

During Suspend, if you push the switch one time, the system goes into suspend mode and if you push it more than 4 seconds, the system will be turned off. During On/Off, the system will turn off once you push the switch.

Ring Resume from Soft-Off

During Disabled, the system will ignore any incoming call from the modem. During Enabled, the system will boot up if there's an incoming call from the modem.

Note: If you have change the setting, you must let the system boot up until it goes to the operating system. Then, power off the system. This function will work the next time you power on.

RTC Alarm Resume From Soft-Off

This function is for setting the Date, Hour, Minute, and Second for your computer to boot up. During Disabled, you cannot use this function. During Enabled, Choose the Date, Hour, Minute, and Second:

RTC Alarm Date	Choose which day the system will boot up.
RTC Alarm Hour	Choose which hour the system will boot up.
RTC Alarm Minute	Choose which minute the system will boot up.
RTC Alarm Second	Choose which second the system will boot up.

Note: If you have change the setting, you must let the system boot up until it goes to the operating system. Then, power off the system. This function will work the next time you power on.

3.6 PCI/Plug and Play Setup

1. Press <ENTER> on “PCI/Plug and Play Setup” of the main menu screen.

AMIBIOS SETUP - PCI/PLUG AND PLAY SETUP		
(C) 1996 American Megatrends, Inc. All Rights Reserved		
Plug and Play Aware O/S	No	Available Options:
PCI Latency Timer (PCI Clocks)	64	Enabled
PCI VGA Palette Snoop	Disabled	Disabled
Allocate IRQ to PCI VGA	Yes	
PCI IDE Busmaster	Disabled	
OffBoard PCI IDE Card	Auto	
OffBoard PCI IDE Primary IRQ	Disabled	
OffBoard PCI IDE Secondary IRQ	Disabled	
PCI Slot4 IRQ Priority	Auto	
DMA Channel 0	PnP	
DMA Channel 1	PnP	
DMA Channel 3	PnP	
DMA Channel 5	PnP	
DMA Channel 6	PnP	
DMA Channel 7	PnP	
IRQ3	PCI/PnP	
IRQ4	PCI/PnP	
IRQ5	PCI/PnP	
IRQ7	PCI/PnP	
IRQ8	PCI/PnP	
IRQ9	PCI/PnP	
IRQ10	PCI/PnP	ESC:Exit :Sel
IRQ11	PCI/PnP	PgUp/PgDn:Modify
IRQ12	PCI/PnP	F2/F3:Color
IRQ14	PCI/PnP	
IRQ15	PCI/PnP	
Reserved Memory Size	Disabled	
Reserved Memory Address	C8000	

2. Use <Up> and <Down> to choose the item and <PgUp> and <PgDn> keys to modify the highlighted item.
3. After you have finished with the PCI/Plug and Play Setup, press <ESC> to go back to the main menu.

Description of the item on screen follows:**Plug and Play Aware O/S**

Set this option to Yes if the operating system in this computer is aware of and follows the Plug and Play specification. Currently, only Windows® 95 is PnP-aware. The settings are Yes or No. The Optimal and Fail-Safe default settings No.

PCI Latency Timer (PCI Clocks)

This option specifies the latency timings (in PCI clocks) for all PCI devices on the PCI bus. The settings are 32, 64, 96, 128, 160, 192, 224 or 248. The Optimal and Fail-Safe default settings are 64.

PCI VGA Palette Snoop

When this option is set to Enabled, multiple VGA devices operating on different buses can handle data from the CPU on each set of palette registers on every video device. Bit 5 of the command register in the PCI device configuration space is the VGA Palette Snoop bit (0 is disabled). For example, if there are two VGA devices in the computer (one PCI and ISA) and the Bit settings are:

Disabled - Data read and written by the CPU is only directed to the PCI VGA device's palette registers.

Enabled - Data read and written by the CPU is directed to both the PCI VGA device's palette registers and the ISA VGA device palette registers, permitting the palette registers of both devices to be identical.

This option must be set to Enabled if an ISA adapter card requires VGA palette snooping. The settings are Enabled or Disabled. The Optimal and Fail-Safe default settings are Disabled.

Allocate IRQ to PCI VGA

Choose the IRQ to be assigned to the PCI VGA display adapter card. The Optimal and Fail-Safe default setting is No.

PCI IDE BusMaster

Set this option to Enabled to specify that the IDE controller on the PCI local bus includes a bus mastering capability. The settings are Enabled or Disabled. The Optimal and Fail-Safe default settings are Disabled.

Offboard PCI IDE Card

This option specifies if an offboard PCI IDE controller adapter card is installed in the computer. You must specify the PCI expansion slot on the mainboard where the offboard PCI IDE controller is installed. If an offboard PCI IDE controller is used, the onboard IDE controller is automatically disabled. The settings are Auto(AMI® BIOS automatically determines where the offboard PCI IDE controller adapter card is installed), Slot1, Slot2, Slot3 or Slot4. The Optimal and Fail-Safe settings are Auto.

If an offboard PCI IDE controller adapter card is installed in the computer, you must also set the Offboard PCI IDE Primary IRQ and Offboard PCI IDE Secondary IRQ options.

**Offboard PCI IDE Primary IRQ/
Offboard PCI IDE Secondary IRQ**

These options specify the PCI interrupt used by the Primary (or Secondary) IDE channel on the offboard PCI IDE controller. The settings are Disabled, Hardwired, INTA, INTB, INTC or INTD. The Optimal and Fail-Safe default settings are Disabled.

DMA Channel 0/1/3/5/6/7

These options specify the bus that the specified DMA channel is used. These options allow you to reserve DMAs for legacy ISA adapter cards.

These options determine if AMI® BIOS should remove a DMA from the available DMAs passed to devices that are configurable by the system BIOS. The available DMA pool is determined by reading the ESCD NVRAM. If more DMAs must be removed from the pool, the end user can use these options to reserve the DMA by assigning an ISA/EISA setting to it.

IRQ3/IRQ4/IRQ5/RQ7/IRQ9/IRQ10/IRQ11/IRQ14/IRQ15

These options specify the bus that the specified IRQ line is used on. These options allow you to reserve IRQs for legacy ISA adapter cards.

These options determine if AMI® BIOS should remove an IRQ from the pool of available IRQs passed to devices that are configurable by the system BIOS. The available IRQ pool is determined by reading the ESCD NVRAM. If more IRQs must be removed from the pool, the end user can use these options to reserve the IRQ by assigning an ISA/EISA setting to it. Onboard I/O is configured by AMI® BIOS. All IRQs used by onboard I/O are configured as PCI/PnP. If all IRQs are set to ISA/EISA and IRQ14 and 15 are allocated to the onboard PCI IDE, IRQ9 will still be available for PCI and PnP devices, because at least one IRQ must be available for PCI and PnP devices. The settings are ISA/EISA or PCI/PnP. The Optimal and Fail-Safe default settings are IRQ3 through 7 are ISA/EISA. The Optimal and Fail-Safe default settings PCI/PnP.

Reserved Memory Size/Reserved Memory Address

Some ISA cards have ROM at 0C000h~0D000h segments, but in a non-standard format. So Plug & Play BIOS can't detect it. The end user needs to set it up manually. Setting these options under this condition, will inform the BIOS which location and how many location is occupied.

3.7 Peripheral Setup

1. Press <ENTER> on "Peripheral Setup" of the main menu screen.

AMIBIOS SETUP - PERIPHERAL SETUP		
(C) 1996 American Megatrends, Inc. All Rights Reserved		
OnBoard FDC	Enabled	Available Options:
OnBoard Serial PortA	3F8h/COM1	Enabled
OnBoard Serial PortB	2F8h/COM2	Disabled
IR Port Support	Disabled	
IR Base Address Select	2F8	
IR IRQ Select	10	
IR DMA Select	Disabled	
OnBoard Parallel Port	378	
Parallel Port Mode	ECP	
EPP Version	N/A	
Parallel Port IRQ	7	
Parallel Port DMA Channel	3	
Onboard IDE	Both	
		ESC:Exit :Sel PgUp/PgDn:Modify F2/F3:Color

2. Use <up> and <down> to choose the item and <PgUp> and <PgDn> keys to modify the highlighted item.
3. After you have finished with the Peripheral Setup, press <ESC> to go back to the main menu.

Description of the item on screen follows:

Onboard FDC

Choose Auto, for the BIOS to automatically detect the device

If the ISA add-on card has	Onboard FDC to be set at
FDC exist	Disabled
none FDC exist	Enabled

Choose Enabled, Enabling onboard FDC.

Choose Disabled, Disabling onboard FDC.

The Optimal and Fail-Safe default settings are Auto.

Onboard Serial Port A/Onboard Serial Port B

Choose 3F8, for the BIOS to automatically detect the device.

If the ISA add-on card has				Onboard Serial port to be set at			
COM1 (I/O:3F8H)	COM2 (I/O:3F8H)	COM3 (I/O:3E8H)	COM4 (I/O:2E8H)	PORT1	IRQ ASSIGNED	PORT2	IRQ ASSIGNED
✓	✓	✓	✓	DISABLED	X	DISABLED	X
✓	✓	X	X	COM3	4	COM4	3
X	X	✓	✓	COM1	4	COM2	3
✓	X	X	✓	COM2	3	COM3	4
X	✓	✓	X	COM1	4	COM4	3
✓	✓	✓	X	COM4	3	DISABLED	X
✓	✓	X	✓	COM3	4	DISABLED	X
✓	X	✓	✓	COM2	3	DISABLED	X
X	✓	✓	✓	COM1	4	DISABLED	X
X	X	X	X	COM1	4	COM2	3
✓	X	X	X	COM2	3	COM3	4
X	✓	X	X	COM1	4	COM3	4
X	X	✓	X	COM1	4	COM2	3
X	X	X	✓	COM1	4	COM2	3

Note: If the onboard serial port interrupt and ISA add-on card interrupt are in conflict, the serial port will not work properly. Please disable one of the devices.

IR Port Support

Choose Auto, the BIOS will automatically assigned onboard port for IR.

IR Base Address Select

This option will assigned which base address will be used by IR

IR IRQ Select

This option is for selecting the IRQ for the IR.

IR DMA Select

This option is for selecting the DMA for the IR.

Onboard Parallel Port

Choose Auto, the BIOS automatically assigned onboard parallel port to the available parallel port or disabled.

If the ISA add-on card has			Onboard parallel port to be set as	
LPT1 I/O:378H	LPT2 I/O:278H	LPT3 I/O:3BCH	PORT ASSIGNED	IRQ ASSIGNED
✓	✓	✓	Disabled	X
✓	✓	X	LPT3	5
✓	X	✓	LPT2	5
X	✓	✓	LPT1	7
✓	X	X	LPT2	5
X	✓	X	LPT1	7
X	X	✓	LPT1	7
X	X	X	LPT1	7

Note: *If the onboard parallel port interrupt and ISA add-on card interrupt are in conflict, the parallel port will not work properly. Please disable one of the devices.*

EPP Version

This option is for setting which EPP version will be used. The settings are 1.7 and 1.9.

Parallel Port Mode

This option allows user to choose the operating mode of the onboard parallel port. The settings are Normal, SPP/EPP or ECP mode.

Parallel Port IRQ

If the onboard parallel mode is not on auto mode, the user can select the interrupt line for onboard parallel port. We suggest that the user select the interrupt for the onboard parallel port as shown below:

Onboard parallel port set at	Parallel Port IRQ
LPT1(378H)	7
LPT2(278H)	5
LPT3(3BCH)	5

Parallel Port DMA Channel

This option allows user to choose DMA channel 1 to 3 for the onboard parallel port on ECP mode.

Onboard IDE

Set this option to enable or disable on board IDE controller.

3.8 Hardware Monitor Setup

The Hardware Monitor Setup is used to monitor the Current CPU temperature, CPU Fan speed, Chassis Fan Speed, Power fan speed, Vcore, and etc.

AMIBIOS SETUP - HARDWARE MONITOR SETUP		
(C) 1996 American Megatrends, Inc. All Rights Reserved		
--System Hardware Monitor--		Available Options:
Current CPU Temperature	30°c/100°f	Enabled
Current CPU Fan Speed	5273RPM	Disabled
Current Chassis Fan Speed	0 RPM	
Current Power Fan Speed	0 RPM	
Vcore	2.2V	
Vtt	1.5V	
Vio	3.3V	
+5,000V	+5V	
+12,000V	+12V	
-12,000V	-12V	
-5,000V	-5V	
		ESC:Exit :Sel
		PgUp/PgDn:Modify
		F2/F3:Color

Chapter 4**AWARD® BIOS SETUP**

Award® BIOS ROM has a built-in Setup program that allows users to modify the basic system configuration. This type of information is stored in battery-backed RAM (CMOS RAM), so that it retains the Setup information when the power is turned off.

Chipset Features Setup

This setup page includes all the items of chipset special features.

Power Management Setup

This category determines the power consumption for system after setting the specified items. Default value is Disable.

PCI Configuration Setup

This category specifies the IRQ level for PCI and ISA devices.

Supervisor Password/User Password

Change set or disable password. This function allows the user access to the system and setup or just setup.

Load Setup Defaults

Chipset defaults indicates the values required by the system for the maximum performance.

Special Features Setup

This function is reserved for LM78.

IDE HDD Auto Detection

Automatically configure hard disk parameters.

Save & Exit Setup

Save CMOS value changes to CMOS and exit setup.

Exit Without Saving

Abandon all CMOS value changes and exit setup.

4.4 Standard CMOS Setup

The items in Standard CMOS Setup Menu are divided into 10 categories. Each category includes no, one or more than one setup items. Use the arrow keys to highlight the item and then use the <PgUp> or <PgDn> keys to select the value you want in each item.

ROM PCI/ISA BIOS (2A59IM4A)
STANDARD CMOS SETUP
AWARD SOFTWARE, INC.

Date(mm:dd:yy): Fri, Feb 28, 1997	
Time(hh:mm:ss): 00:00:00	
HARD DISKS	TYPE SIZE CYLS HEADS PRECOMP LANDZONE SECTOR MODE
Primary Master:	Auto 0 0 0 0 0 0 AUTO
Primary Slave :	Auto 0 0 0 0 0 0 AUTO
Secondary Master :	Auto 0 0 0 0 0 0 AUTO
Secondary Slave :	Auto 0 0 0 0 0 0 AUTO
Drive A : 1.44M, 3.5in.	Base Memory: 640K Extended Base Memory: 15360K Other Memory: 384K
Drive B : None	
Video : EGA/VGA	Total Memory: 16384K
Halt On : All, but Keyboard	
ESC : Quit ↑↓→← : Select Item F0/FD/+/- : Modify	
F1 : Help (Shift)F2 : Change Color	

Date

The date format is <day><month> <date> <year>.

Day	Day of the week, from Sun to Sat, determined by BIOS. Read-only.
month	The month from Jan. through Dec.
date	The date from 1 to 31 can be keyed by numeric function keys.
year	The year, depends on the year of the BIOS

Time

The time format is <hour> <minute> <second>.

PrimaryMaster/PrimarySlave**SecondaryMaster/Secondary Slave**

These categories identify the types of 2 channels that have been installed in the computer. There are 45 pre-defined types and 4 user definable types for Enhanced IDE BIOS. Type 1 to Type 45 are pre-defined. Type User is user-definable.

Press PgUp/<+> or PgDn/<-> to select a numbered hard disk type or type the number and press <Enter>. Note that the specifications of your drive must match with the drive table. The hard disk will not work properly if you enter improper information for this category. If your hard disk drive type is not matched or listed, you can use Type User to define your own drive type manually.

If you select Type User, related information is asked to be entered to the following items. Enter the information directly from the keyboard and press <Enter>. This information should be provided in the documentation from your hard disk vendor or the system manufacturer.

If the controller of HDD interface is ESDI, the selection shall be "Type 1".

If the controller of HDD interface is SCSI, the selection shall be "None".

If the controller of HDD interface is CD-ROM, the selection shall be "None".

CYLS.	number of cylinders
HEADS	number of heads
PRECOMP	write precom
LANDZONE	landing zone
SECTORS	number of sectors
MODE HDD	access mode

4.5 BIOS Features Setup

ROM PCI/ISA BIOS (2A59IM4A)
 BIOS FEATURES SETUP
 AWARD SOFTWARE, INC.

Virus Warning : Disabled	Video BIOS Shadow : Enabled
CPU Internal Cache : Enabled	C0000-CBFFF Shadow : Disabled
External Cache : Enabled	CC000-CFFFF Shadow : Disabled
Quick Power on Self Test : Disabled	D0000-D3FFF Shadow : Disabled
Boot Sequence : A,C,SCSI	D4000-D7FFF Shadow : Disabled
Swap Floppy Drive : Disabled	D8000-DBFFF Shadow : Disabled
Boot up NumLock status : On	DC000-DFFFF Shadow : Disabled
Security Option : Setup	
PCI/VGA palette snoop : Disabled	
OS select for DRAM>64MB : Non-OS2	
Report No FDD For WIN 95 : Yes	

Esc : Quit	↑↓→← : Select Item
F1 : Help PU/PD/+/-	: modify
F5 : Old Value(Shift)	F2 : Color
F6 : Load BIOS Defaults	
F7 : Load Setup Defaults	

Virus Warning

During and after the system boots up, any attempt to write to the boot sector or partition table of the hard disk drive will halt the system and the following error message will appear. For the meantime, you can run an anti-virus program to locate the problem.

!WARNING!
 Disk Boot Sector is to be modified
 Type "Y" to accept write or "N" to abort write
 Award Software, Inc.

Disabled (default) No warning message to appear when anything attempts to access the boot sector or hard disk partition table.

Enabled Activates automatically when the system boots up causing a warning message to appear when anything attempts to access the boot sector of hard disk partition table.

Note: This function is available only for DOS and other OS that do not trap INT13.

CPU Internal Cache

The default value is Enabled. If your CPU is without Internal Cache then this item "CPU Internal Cache" will not be shown.

Enabled (default) Enable cache
Disabled Disable cache

Note: The external cache is built in the processor.

CPU External Cache

Choose Enabled or Disabled. This option enables the level 2 cache memory.

Quick Power On Self Test

This category speeds up Power On Self Test (POST) after you power on the computer. If this is set to Enabled, BIOS will shorten or skip some check items during POST.

Enabled Enable quick POST
Disabled (default) Normal POST

Boot Sequence

This category determines which drive the computer searches first for the disk operating system (i.e., DOS). The settings are A,C,SCSI/C,A,SCSI/C,CD-ROM,A/CD-ROM,C,A/D,A,SCSI/E,A,SCSI/F,A,SCSI/SCSI,A,C/SCSI,C,A/C only. Default value is A,C,SCSI.

Swap Floppy Drive

Switches the floppy disk drives between being designated as A and B. Default is Disabled.

Boot Up NumLock Status

The default value is On.

On (default) Keypad is numeric keys.
Off Keypad is arrow keys.

Security Option

This category allows you to limit access to the system and Setup, or just to Setup.

System The system will not boot and access to Setup will be denied if the correct password is not entered at the prompt.
Setup(default) The system will boot, but access to Setup will be denied if the correct password is not entered at the prompt.

PCI VGA Palette Snooping

Choose Disabled or Enabled. Some graphic controllers which are not VGA compatible, take the output from a VGA controller and map it to their display as a way to provide the boot information and the VGA compatibility.

However, the color information coming from the VGA controller is drawn from the palette table inside the VGA controller to generate the proper colors, and the graphic controller needs to know what is in the palette of the VGA controller. To do this, the non-VGA graphic controller watches for the Write access to the VGA palette and registers the snoop data. In PCI based systems, where the VGA controller is on the PCI bus and a non-VGA graphic controller is on an ISA bus, the Write Access to the palette will not show up on the ISA bus if the PCI VGA controller responds to the Writes.

In this case, the PCI VGA controller should not respond to the Write. It should only snoop the data and permit the access to be forwarded to the ISA bus. The non-VGA ISA graphic controller can then snoop the data on the ISA bus. Unless you have the above situation, you should disable this option.

Disabled (default) Disables the function
Enabled Enables the function

OS Selection for DRAM > 64MB

Allows OS2® to be used with > 64 MB of DRAM. Settings are Non-OS/2 (default) and OS2. Set to OS/2 if using more than 64MB and running OS/2®.

Report No FDD For WIN 95

This function is only use when you are testing SCT for Windows® 95 Logo.

Video BIOS Shadow

Determines whether video BIOS will be copied to RAM for faster execution. Video shadow will increase the video performance.

Enabled (default)	Video shadow is enabled
Disabled	Video shadow is disabled

C8000 - CFFFF Shadow/E8000 - EFFFF Shadow

Determines whether the optional ROM will be copied to RAM for faster execution.

Enabled	Optional shadow is enabled
Disabled (default)	Optional shadow is disabled

Note: For C8000-DFFFF optional-ROM on PCI BIOS, BIOS will automatically enable the shadow RAM. User does not have to select the item.

4.6 Chipset Features Setup

The Chipset Features Setup option is used to change the values of the chipset registers. These registers control most of the system options in the computer.

Choose the "CHIPSET FEATURES SETUP" from the Main Menu and the following screen will appear.

ROM PCI/ISA BIOS (2A59IM4A)
CMOS SETUP UTILITY
CHIPSET FEATURES SETUP

Auto Configuration	: Enabled	
DRAM Timing	: 60ns	
DRAM Leadoff Timing	: 10/6/4	
DRAM Read Burst (EDO/FP)	: x222/x333	
DRAM Write Burst Timing	: x222	
Fast EDO Lead Off	: Enabled	
Refresh RAS# Assertion	: 4	
Fast RAS to CAS Delay	: 3	
DRAM Page IDLE Timer	: 2	
DRAM Enhanced Paging	: Enabled	
Fast MA to RAS# Delay	: 2 Ckts	
SDRAM (CAS Lat/RAS-to-CAS)	: 3/3	
SDRAM Speculative Read	: Disabled	
System BIOS Cacheable	: Enabled	
Video BIOS Cacheable	: Enabled	
8 Bit I/O Recovery Time	: NA	
16 Bit I/O Recovery Time	: NA	
Memory Hole at 15M-16M	: Disabled	
PCI 2.1 compliance	: Enabled	
		Esc : Quit ↑↓→← : Select item
		F1 : Help PD/PD/+- : modify
		F5 : Old Value (Shift) F2 : Color
		F6 : Load BIOS Defaults
		F7 : Load Setup Defaults

Note: Change these settings only if you are familiar with the chipset.

Auto Configuration

Choosing Enabled (default) will automatically configure chipset features using default settings. Choose Disable to customize setup.

DRAM Timing

Sets the DRAM speed at 70ns (default) or 60ns. It will set the speed of the EDO/FP DRAM.

DRAM Leadoff Timing

To be able to change the setting, Auto configuration must be disable. If the Bus Clock is 75MHz set it to 11/7/4, and if the Bus Clock is 66/60/55 MHz set it to 10/6/4. Default setting is 10/6/4.

DRAM Read Burst (EDO/FP)

Under Auto config. the BIOS will identify which type of DRAM is being used. Choose the setting accordingly. To customize, use this option which sets the Read Burst time for accessing the DRAM. The timing used depends on the type of DRAM and access time being used. The settings are x222/x333, x333/x444, or x444/x444.

Note: If the user chooses DRAM Read Burst (EDO/FP): x333/x444 it signifies that:

- a. 60ns EDO with 75 MHz Bus Clock is set at x333, if the Bus Clock is 66/60/55 MHz, then it is set at x222.
- b. 60ns FP with 75 MHz is set at x444, if the Bus Clock is 66/60/55, then it is set at x333.
- c. 70ns EDO and FP DRAM must increase the burst time. So you must set x222 to x333 and x333 to x444.

DRAM Write Burst Timing

This option chooses the Write Burst Timing for accessing DRAM. See: DRAM Read Burst Option. Choose x222/x333/x444.

Fast EDO Lead Off

Under Auto config. the BIOS will identify which type of DRAM is being used. Choose the setting accordingly. To customize, use this option. Choose Enable or Disable. If the system is using EDO DRAM, choose enable. But if the system is using both EDO and FP DRAM, choose Disable.

Refresh RAS# Assertion

The settings are 4 Clks or 5 Clks. Using 60 ns DRAM at 75 Mhz Bus Clock must be set to 5 Clks, while 66/60/55 Mhz Bus Clock must be set to 4 Clks. But if you use 70 ns DRAM, it must be set to 5 Clks.

Fast RAS to CAS Delay

The settings are 2 or 3. 2 RAS to CAS delay is set to 2 clock, while 3 RAS to CAS delay is set to 3 clock. The clock is dependent with the DRAM Timing and Bus Clock.

DRAM Page IDLE Timer

The settings are 2 Clks, 4 Clks, 6Clks, or 8 Clks. Default settings is 2 Clks.

DRAM Enhanced Paging

Choose Enable(default) or Disable.

Fast MA to RAS# Delay

The settings are 1 Clks or 2 Clks(default). During 1T, one bus clock is allowed, while 2T allows two bus clock for MA address setup time to RAS assertion. This is also dependent on DRAM Timing.

SDRAM (CAS Lat/RAS-to-CAS)

The settings are 3/3 or 2/2. This option is for SDRAM CAS latency time and RAS# to CAS# delay time. The default setting is 3/3.

SDRAM Speculative Read

The settings are enable or disable. If you only use One Bank for SDRAM and there's no EDO or FP mix together, the setting is Enable. If two banks are used by SDRAM, it will automatically be set to disable. The default setting is enable.

System BIOS Cacheable

By choosing Disabled (default) the system BIOS will be shadowed into DRAM only. Enabled will have the system BIOS shadowed and cacheable.

Video RAM Cacheable

Same as system BIOS Cacheable

8-bit I/O recovery time: 1/2/3/4/5/6/7/NA

16-bit I/O recovery time: 1/2/3/NA

Choose the recovery time for 8-bit and 16-bit I/O cycles respectively.

Note: NA is not available and so the recovery time of 3.5 SYSCLK will be inserted.

Memory Hole At 15M-16M

Choosing Enabled will enable a memory hole in the DRAM space. The CPU cycle matching the enabled hole will be passed on to the PCI. PCI cycles matching an enabled hole are ignored. Disabled (default) will disable this function.

Note: A selected (Enabled) hole is not remapped.

PCI 2.1 Compliance

The Settings are Enable or Disable. During Enable, those PCI add-on cards with PCI 2.1 compliance will perform better. But some PCI card does not meet PCI 2.1 compliance, so the default setting is Disabled.

4.7 Power Management Setup

The Power Management Setup will appear on your screen like this:

ROM PCI/ISA BIOS (2A59IM4A)
POWER MANAGEMENT SETUP
AWARD SOFTWARE, INC.

Power Management	:User Define	** Reload Global Timer Events **
PM Control by APM	:Yes	IRQ (3-7,9-15),NMI : Enabled
Video Off Method	:DPMS	Primary IDE 0 : Enabled
Video Off After	:Standby	Primary IDE 1 : Disabled
		Secondary IDE 0 : Disabled
Doze Mode	:Disabled	Secondary IDE 1 : Disabled
Standby Mode	:Disabled	Floppy Disk : Enabled
Suspend Mode	:Disabled	Serial Port : Enabled
HDD Power Down	:Disabled	Parallel Port : Enabled
Throttle Duty Cycle	:62.5%	
VGA Active Monitor	:Disabled	
Soft-Off by PWR-BTTN	:Instant-Off	
Resume by Ring	:Disabled	
Resume by Alarm	:Disabled	
		** Break Event From Suspend **
		IRQ 8 Clock Event : Disabled
		Esc : Quit ↑↓→← : Select item
		F1 : Help PU/PD/+/- : modify
		F5 : Old Value(Shift) F2 : Color
		F6 : Load BIOS Defaults
		F7 : Load Satup Defaults

Power Management

This category determines the power consumption for system after selecting below items. Default value is Disable. The following pages tell you the options of each item & describe the meanings of each options.

Power Management

Disable	Global Power Management will be disabled.
User Define	Users can configure their own power management.
Min Saving	Pre-defined timer values are used such that all timers are in their MAX value.
Max Saving	Pre-defined timer values are used such that all timers are in their MIN value.

PM Control by APM

No	System BIOS will ignore APM when power managing the system.
Yes	System BIOS will wait for APM's prompt before it enter any PM mode

Note : Enable this for O.S. with APM like Windows® 95, Windows® NT, etc.

Video Off Method

Blank Screen	The system BIOS will only blank off the screen when disabling video.
V/H SYNC+Blank	In addition to (1), BIOS will also turn off the V-SYNC & H-SYNC signals from VGA card to monitor.
DPMS	This function is enabled only for VGA card supporting DPMS.

Note: Green monitors detect the V/H SYNC signals to turn off its electron gun.

Video Off After

The settings are N/A, Standby, Doze, or Suspend. This option is for choosing the setting in which the monitor will turn off.

N/A	Always turn on.
Doze	During Doze mode, the monitor will be turned off.
Standby	During Standby mode, the monitor will be turned off.
Suspend	During Suspend mode, the monitor will be turned off.

The default setting is Standby.

Doze Mode

Disable	System will never enter DOZE mode.
1 Min/2 Min/ 4 Min/6 Min/ 8 Min/10 Min/ 20 Min/30 Min/ 40 Min/1 Hr	Defines the continuous idle time before the system enters DOZE mode. If any item defined in the options of "Power Down and Resume events" is enabled & active, DOZE timer will be reloaded. When the system have entered Doze mode, any of the items enabled in "Wake Up Events in Doze and Standby" will trigger the system to wake up.

Standby Mode

Disable	System will never enter STANDBY mode.
1 Min/2 Min/ 4 Min/6 Min/ 8 Min/10 Min/ 20 Min/30 Min/ 40 Min/1 Hr	Defines the continuous idle time before the system enters STANDBY mode. If any item defined in the options of "Power Down and Resume events" is enabled & active, STANDBY timer will be reloaded. When the system has entered Standby mode, any of the items that are enabled in "Wake Up Events of Doze and Standby" will trigger the system to wake up.

Suspend Mode

Disable	System will never enter SUSPEND mode.
1 Min/2 Min/ 4 Min/6 Min/ 8 Min/10 Min/ 20 Min/30 Min/ 40 Min/1 Hr	Defines the continuous idle time before the system enters SUSPEND mode. If any item defined in the options of "Power Down & Resume Events" is enabled & active, SUSPEND timer will be reloaded. When the system has entered SUSPEND mode, any of the items enabled in the "Power Down & Resume Events" will trigger the system to wake up.

HDD Power Down

Disable	HDD's motor will not shut off.
1 Min/2 Min/ 3 Min/4 Min/ 5 Min/6 Min/ 7 Min/8 Min/ 9 Min/10 Min/ 11 Min/12 Min/ 13 Min/14 Min/ 15 Min	Defines the continuous HDD idle time before the HDD enters the power saving mode (motor off). BIOS will turn off the HDD's motor when time is out.

Throttle Duty Cycle

This option will determine how much power will be used by the CPU, if the system goes into suspend mode.

VGA Active Monitor

During Enabled, if there's no activity in the monitor screen the system will go into Power Saving Mode. During Disabled, the system will go into Power Saving Mode, whether there is activity in the monitor screen or not. The settings are Disabled and Enabled.

Soft-Off by PWR-BTTN

The settings are Delay 4 sec or Instant-off. During Delay 4 sec, if you push the switch one time, the system goes into suspend mode and if you push it more than 4 second, the system will be turned off. During instant-off, the system will turn off once you push the switch.

Resume by Ring

During Disabled, the system will ignore any incoming call from the modem. During Enabled, the system will boot up if there's an incoming call from the modem.

Note: If you have change the setting, you must let the system boot up until it goes to the operating system, before this function will work.

Resume by Alarm

This function is for setting date and time for your computer to boot up. During Disabled, you cannot use this function. During Enabled, choose the Date and Time Alarm:

Date(of month) Alarm	You can choose which month the system will boot up.
Time(hh:mm:ss) Alarm	You can choose what hour, minute and second the system will boot up.

Note: If you have change the setting, you must let the system boot up until it goes to the operating system, before this function will work.

IRQ 8 Clock Event

IRQ[3-7,9-15], NMI : Enabled
 Primary IDE 0 : Enabled
 Primary IDE 1 : Disabled
 Secondary IDE 0 : Disabled
 Secondary IDE 1 : Disabled
 Floppy Disk : Enabled
 Serial Port : Enabled
 Parallel Port : Enabled

During Enabled, if any interrupt event occurs, the system will wake-up from suspend mode. During Disabled, the system will not monitor any interrupt event.

4.8 PNP/PCI Configuration Setup

You can manually configure the PCI Device's IRQ. The following pages tell you the options of each item & describe the meanings of each options.

ROM PCI/ISA BIOS (2A69HM4D)
 PNP/PCI CONFIGURATION SETUP
 AWARD SOFTWARE, INC.

PnP OS Installed	: No	PCI IDE IRQ Map To	: PCI-Auto
Resources Controlled By	: Manual	Primary IDE INT#	: A
Reset Configuration Data	: Disabled	Secondary IDE INT#	: B
IRQ-3 assigned to	: Legacy ISA	Assign IRQ for VGA	: Enabled
IRQ-4 assigned to	: Legacy ISA	Used MEM base addr	: N/A
IRQ-5 assigned to	: PCI/ISA PnP		
IRQ-7 assigned to	: PCI/ISA PnP		
IRQ-9 assigned to	: PCI/ISA PnP		
IRQ-10 assigned to	: PCI/ISA PnP		
IRQ-11 assigned to	: PCI/ISA PnP		
IRQ-12 assigned to	: PCI/ISA PnP		
IRQ-14 assigned to	: PCI/ISA PnP		
IRQ-15 assigned to	: PCI/ISA PnP		
DMA-0 assigned to	: PCI/ISA PnP		
DMA-1 assigned to	: PCI/ISA PnP		
DMA-3 assigned to	: PCI/ISA PnP		
DMA-5 assigned to	: PCI/ISA PnP		
DMA-6 assigned to	: PCI/ISA PnP		
DMA-7 assigned to	: PCI/ISA PnP		
		Esc : Quit ↑↓→+ : Select Item	
		F1 : Help PU/PD/+/~ : modify	
		F5 : Old Value(Shift) F2 : Color	
		F6 : Load BIOS Defaults	
		F7 : Load Setup Defaults	

PnP OS Installed

When set to YES, BIOS will only initialize the PnP cards used for booting (VGA, IDE, SCSI). The rest of the cards will be initialized by the PnP operating system like Windows® 95. When set to NO, BIOS will initialize all the PnP cards. So, for non-PnP operating system (DOS, Netware®), this option must set to NO.

Assign IRQ for VGA

Lets the user choose which IRQ to assign for VGA card.

Used MEM base addr

Lets the user choose the Legacy ISA addr. The settings are NA#, C800, CC00, D000, D400, D800 OR DC00.

4.9 Load BIOS/Setup Defaults

This Main Menu item loads the default system values. If the CMOS is corrupted the defaults are loaded automatically. Choose this item and the following message appears:

“ Load Setup Defaults (Y / N) ? N “

To use the Setup defaults, change the prompt to “Y” and press < Enter >

Note: The Setup defaults can be customized to increase performance. However the BIOS defaults can always be used as a back up if there is some problem with the mainboard operation.

4.10 Special Features Setup

This Special Features Setup are use by LM78 chipset. You can manually change the value of each option.

ROM PCI/ISA BIOS (2A69HM4C)
INTEGRATED PERIPHERALS
AWARD SOFTWARE, INC.

CPU Type: Intel Pentium	System Temperature	:29°C/84°F
CPU Voltage :Auto	CPU Temperature	:30°C/86°F
Voltage Detected :Enabled		
Power Fan Detected :Disabled		
CPU FAN Detected :Enabled		
Esc : Quit ↑↓→← : Select Item		
F1 : Help PU/PD/+/- : modify		
F5 : Old Value(Shift) F2 : Color		
F6 : Load BIOS Defaults		
F7 : Load Setup Defaults		

CPU Voltage

This is for setting the voltage of the CPU you are using, so that LANDesk® application can monitor your CPU voltage.

Voltage Detected

During Enabled, this will show the CPU voltage chart during boot up. And during Disabled, this will not show the CPU voltage chart.

Power Fan Detected

During Enabled, this will monitor your power fan.

CPU Fan Detected

During Enabled, this will monitor the RPM of your CPU fan.

System Temperature/CPU Temperature

This will show the System and CPU temperature.

4.11 Integrated Peripherals

ROM PCI/ISA BIOS (2A69HM4D)
 INTEGRATED PERIPHERALS
 AWARD SOFTWARE, INC.

IDE HDD Block Mode	: Enabled	Onboard Parallel Mode	: LPT/IRQ7
IDE Primary Master PIO	: Auto	Parallel Port Mode	: EPP
IDE Primary Slave PIO	: Auto	ECP Mode Use DMA	: 1,3
IDE Secondary Master PIO	: Auto	EPP Mode Select	: EPP1
IDE Secondary Slave PIO	: Auto		
IDE Primary Master UDMA	: Auto		
IDE Primary Slave UDMA	: Auto		
IDE Secondary Master UDMA	: Auto		
IDE Secondary Slave UDMA	: Auto		
On-Chip Primary PCI IDE	: Enabled		
On-Chip Primary PCI IDE	: Enabled		
USB Keyboard Controller	: Disabled		
Onboard Floppy controller	: Enabled		
Onboard Serial Port 1	: 3F8/IRQ4		
Onboard Serial Port 2	: 2F8/IRQ3		
Onboard IR Controller	: Disabled		

Esc : Quit ↑↓→← : Select item
 F1 : Help PD/PD+/- : modify
 F5 : Old Value (Shift) F2 : Color
 F6 : Load BIOS Defaults
 F7 : Load Setup Defaults

IDE HDD Block Mode

Enabled/Disabled Enabled allows the Block mode access for the IDE HDD.

IDE Primary Master PIO

Auto/Mode0/Mode1-4

IDE Primary Slave PIO

Auto/Mode0/Mode1-4

IDE Secondary Master PIO

Auto/Mode0/Mode1-4

IDE Secondary Slave PIO

Auto/Mode0/Mode1-4

For these 4 IDE options, choose "Auto" to have the system BIOS auto detect the IDE HDD operation mode for PIO access.

Note: Some IDE HDD can not operate at the responding HDD's mode. When the user has selected "Auto" and the system BIOS has accepted the HDD response mode, the user may degrade the HDD's operation mode. Ex: IF the HDD reported it can operate in mode 4 but it is not operating properly, the user will have to manually change the operation mode to mode 3.

Choosing Mode 1-4 will have the system ignore the HDD's reported operation mode and use the selected mode instead.

Note: According to ATA specs. Mode 4 transfer rate is > Mode 3 > Mode 2 > Mode 1 > Mode 0. If the user's HDD can operate at Mode 3 the user can also select a slower Mode (i.e. Mode 0-2) but not a faster Mode (ie Mode 4).

On-Chip Primary PCI IDE

Enabled/Disabled

On-Chip Secondary PCI IDE

Enabled/Disabled

The system provides for a On-Board On-Chipset PCI IDE controller that supports Dual Channel IDE (Primary and Secondary). A maximum of 4 IDE devices can be supported. If the user install the Off-Board PCI IDE controller (i.e. add-on cards), the user must choose which channels will be disabled. This will depend on which channel will be used for the Off-Board PCI IDE add-on card.

USB Keyboard Support

Enabled/Disabled

Choosing Enabled will allow the system to use USB keyboard without a device driver.

Onboard FDC Controller

Enabled/Disabled

The system has an on-board Super I/O chip with a FDD controller that supports 2 FDDs for 360K/720K/1.2M/1.44M/2.8M. Choose "Enabled" to use the on-board FDD controller for accessing the FDD. Otherwise choose "Disabled" to use the off-board FDD controller.

Onboard Serial Port 1

Disabled/(3F8/IRQ4)/(2F8/IRQ3)/(3E8/IRQ4)/(2E8/IRQ3)

Onboard Serial Port 2

Disabled/(3F8/IRQ4)/(2F8/IRQ3)/(3E8/IRQ4)/(2E8/IRQ3)

The system has an On-board Super I/O chipset with 2 serial ports. The On-board serial ports can be selected as:

Disabled	
3F8/IRQ4	COM 1 uses IRQ4
2F8/IRQ3	COM 2 uses IRQ3
3E8/IRQ4	COM 3 uses IRQ4
2E8/IRQ3	COM 4 uses IRQ4

Note: Because the ISA Bus Interrupt accepts low to high edge trigger, the interrupt request line cannot be shared by multiple sources. If an off-board ISA add-on card with a serial port is installed the user may have to disable the on-board serial port because it will conflict with IRQ request line for the off-board serial port.

Onboard IR Controller

Enabled/Disabled

The system has an on-board Super I/O chip with an IR controller. Choose "Enabled" to use the on-board IR controller for accessing the IR devices. Otherwise choose "Disabled" to use the off-board IR controller.

Onboard Parallel Port

Disabled
(3BCH/IRQ7)
(278H/IRQ5)
(378H/IRQ5)

There is a built-in parallel port on the on-board Super I/O chipset that provides Standard, ECP, and EPP features. It has the following options:

Disable	
3BCH/IRQ7	Line Printer port 0
278H/IRQ5	Line Printer port 2
378H/IRQ5	Line Printer port 1

Onboard Parallel Mode

SPP : Standard Parallel Port
EPP : Enhanced Parallel Port
ECP : Extended Capability Port

SPP/(EPP/SPP)
ECP(ECP/EPP)

To operate the onboard parallel port as Standard Parallel Port only, choose "SPP." To operate the onboard parallel port in the ECP and SPP modes simultaneously choose "ECP/SPP." By choosing "ECP", the onboard parallel port will operate in ECP mode only. Choosing "ECP/EPP" will allow the onboard parallel port to support both the ECP and EPP modes simultaneously. The ECP mode has to use the DMA channel, so choose the onboard parallel port with the ECP feature. After select-

ing it, the following message will appear: "ECP Mode Use DMA" At this time the user can choose between DMA channels 3 or 1. The onboard parallel port is EPP Spec. compliant, so after the user chooses the onboard parallel port with the EPP function, the following message will be displayed on the screen: "EPP Mode Select." At this time either EPP 1.7 spec. or EPP 1.9 spec. can be chosen.

4.11 Supervisor/User Password Setting

This Main Menu item lets you configure the system so that a password is required each time the system boots or an attempt is made to enter the Setup program. Supervisor Password allows you to change all CMOS settings but the User Password setting doesn't have this function. The way to set up the passwords for both Supervisor and User are as follow:

1. Choose "Change Password" in the Main Menu and press <Enter>. The following message appears:

"Enter Password:"

2. The first time you run this option, enter your password up to only 8 characters and press <Enter>. The screen does not display the entered characters. For no password just press <Enter>.

3. After you enter the password, the following message appears prompting you to confirm the password:

"Confirm Password:"

4. Enter exactly the same password you just typed in to confirm the password and press <Enter>.
5. Move the cursor to Save & Exit Setup to save the password.
6. If you need to delete the password you entered before, choose the Supervisor Password and press <Enter>. It will delete the password that you had before.
7. Move the cursor to Save & Exit Setup to save the option you did. Otherwise, the old password will still be there when you turn on your machine next time.

4.12 IDE HDD Auto Detection

You can use this utility to automatically detect the characteristics of most hard drives.

When you enter this utility, the screen asks you to select a specific hard disk for Primary Master. If you accept a hard disk detected by the BIOS, you can enter "Y" to confirm and then press <Enter> to check next hard disk. This function allows you to check four hard disks and you may press the <Esc> after the <Enter> to skip this function and go back to the Main Menu.

ROM ISA BIOS
CMOS SETUP UTILITY
AWARD SOFTWARE, INC.

HARD DISKS	TYPE	SIZE	CYLS	HEADS	PRECOMP	LANDZONE	SECTOR MODE
Primary Master:	Auto	0	0	0	0	0	AUTO
Primary Slave :	Auto	0	0	0	0	0	AUTO
Secondary Master :	Auto	0	0	0	0	0	AUTO
Secondary Slave :	Auto	0	0	0	0	0	AUTO

Select Primary Master		Option (N=Skip) : N					
OPTIONS	SIZE	CYLS	HEAD	PRECOMP	LANDZ	SECTOR MODE	
2	2112	1023	64	0	4094	63 LBA	
1	2113	4095	16	65535	4094	63 NORMAL	
3	2113	2047	32	65535	4094	63 LARGE	

[ESC: Skip]

MS-6117

MSI LX6 Mainboard

Designed for Pentium® II Processor

CONNECTOR

PS/2 K/B +
PS/2 Mouse

USB CONN.

Dual USB Ports,
with over-current
protection

CHIPSET

Intel® 440LX

SUPER I/O

16550 Fast UART,
EPP/ ECP Printer
Port & SIR/MIR/
FIR/ASK-IR Opt.

FLASH BIOS

AMI® / AWARD®
PnP BIOS

SWITCHING VOLTAGE REG.

Switching
Voltage Reg.
on board
(Meets Intel®
VRM Spec 8.1)

SIZE & FORM FACTOR

30.5 x 18.6 cm
ATX double deck
compatible with
Intel® Venus

MORE FEATURES

LM78 H/W Monitor,
Modem Ring
Wakeup, Soft
Power Off

CPU SLOT

Slot One x 1,
Supports Intel®
233 to 300 MHz
Pentium® II
processor

MEMORY

3 pcs. DIMM,
Max. 384MB
with SDRAM or
768MB with
EDO/FP

AGP

Provides 1 AGP
slot, supports
66/133MHz 3.3V

PCI IDE

Dual channel,
Supports Ultra
DMA 33

SLOTS

2 16-bit ISA
5 32-bit PCI
(1 shared)

[CLICK HERE FOR
MORE INFO](#)

