Contents

Chapter 1 Quick Installation	3
1.1 Layout	3
1.2 CPU setting	4
1.3 Jumpers	4
1.4 Expansion Slots / Sockets	7
1.5 Connectors	9
1.6 Form Factor	16
Chapter 2 Overview	17
2.1 What is RAID?	18
2.2 What is IDE RAID?	18
Chapter 3 Features	20
3.1 Motherboard Components Placement	20
3.2 Back Panel	22
3.3 Block Diagram	23
3.4 Specifications	24
Chapter 4 Hardware Setup	26
4.1 Before Installation	26
4.2 Jumper setting	26
4.3 Install the Processor	29
4.4 Install Memory Modules	33

4.5 Install PCI Expansion Cards 34
4.6 Usage of the AMR slot 35
4.7 Usage of the AGP slot 35
4.8 Connect Devices and Power Supply 36

Chapter 5 BIOS Setup 48

5.1 Introduction 48
5.2 Main Menu 49
5.3 Standard CMOS Features 50
5.4 Advanced BIOS Features 53
5.5 Advanced Chipset Features 57
5.6 Integrated Peripherals 60
5.7 Power Management Setup 65
5.8 PnP/ PCI Configurations 69
5.9 PC Health Status 72
5.10 IWILL Smart Setting 72
5.11 Load Fail-Safe Defaults 73
5.12 Load Optimized Defaults 74
5.13 Set Supervisor / User Password Setting 75
5.14 Save & Exit Setup 75
5.15 Exit Without Saving 75

Chapter 6 Power Installer CD 76

6.1 Software Installation 76
6.2 How to use the Power installer CD 76
6.3 Installing Operating Systems 78

Chapter 1

Quick Installation

Several easy installation steps will be described in this chapter to help the experienced users with quick installation. If you are a beginner, or need to know more about this product, please refer to Hardware Setup.

1.1 Layout

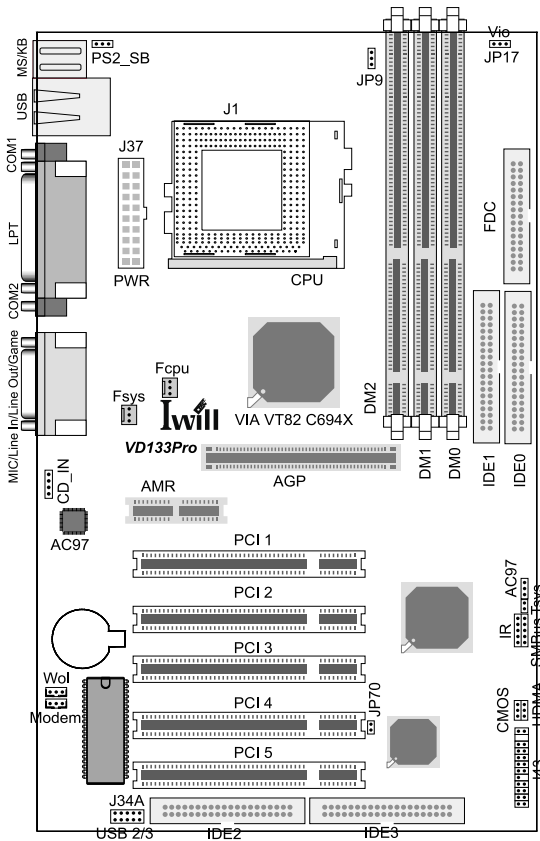

Note: IDE2, IDE3 and JP70 are VD133 Pro only

1.2 CPU setting

This motherboard is designed for Intel® Pentium® III, and Celeron™ through a Socket 370 connector.

CPUModel	Vcore & Package	“CPU Speed” in BIOS
Celeron 300A	2.0V, PPGA	300Mhz(66x4.5)
Celeron 333	2.0V, PPGA	333Mhz(66x5)
Celeron 366	2.0V, PPGA	366Mhz(66x5.5)
Celeron 400	2.0V, PPGA	400Mhz(66x6)
Celeron 433	2.0V, PPGA	433Mhz(66x6.5)
Celeron 466	2.0V, PPGA	466Mhz(66x7)
Celeron 500	2.0V, PPGA	500Mhz(66x7.5)
Celeron 533	2.0V, PPGA	533Mhz(66x8)
Pentium III 500E	1.60V, FCPGA	500Mhz(100x5)
Pentium III 550E	1.60V, FCPGA	550Mhz(100x5.5)
Pentium III 600E	1.65V, FCPGA	600Mhz(100x6)
Pentium III 650E	1.65V, FCPGA	650Mhz(100x6.5)
Pentium III 700E	1.65V, FCPGA	700Mhz(100x7)
Pentium III 533EB	1.60V, FCPGA	533Mhz(133x4)
Pentium III 600EB	1.65V, FCPGA	600Mhz(133x4.5)
Pentium III 667EB	1.65V, FCPGA	667Mhz(133x5)
Pentium III 733EB	1.65V, FCPGA	733Mhz(133x5.5)
Pentium III 650E	1.65V, FCPGA	650Mhz(100x6.5)
Pentium III 700E	1.65V, FCPGA	700Mhz(100x7)
Pentium III 533EB	1.65V, FCPGA	533Mhz(133x4)
Pentium III 600EB	1.65V, FCPGA	600Mhz(133x4.5)
Pentium III 667EB	1.65V, FCPGA	667Mhz(133x5)
Pentium III 733EB	1.65V, FCPGA	733Mhz(133x5.5)

1.3 Jumpers

1.3.1 JP1 (CMOS) Clear CMOS jumper

The jumper is for BIOS setting value.

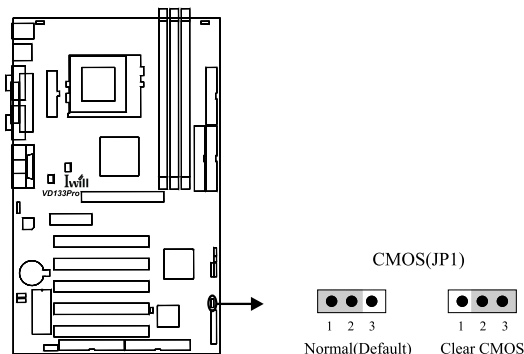

1.3.2 JP9(Vcore+) CPU core voltage select jumper

This function offers adjustable processor Vcore. When NO jumper caps are used, the motherboard automatically generates the proper Vcore voltage that requested by the CPU. Place the jumper cap over pins 1-2 to increase 5% more voltage to the processor's Vcore. Place the jumper cap over pins 2-3 to increase 10% more voltage to the processor's Vcore.

1.3.3 JP10(VIO) VIO select jumper

This jumper is used to select the VIO voltage.

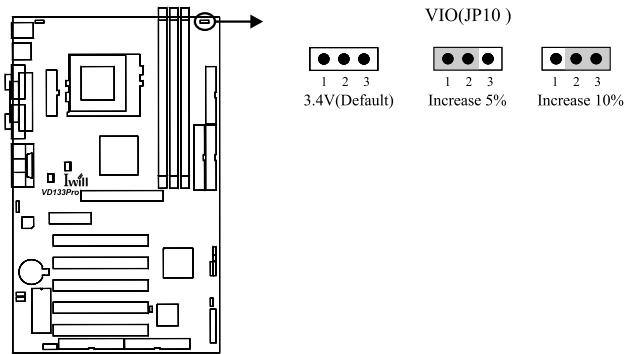

1.3.4 JP13 (AC 97) AC97 Codec Enabled / Disabled jumper

This jumper is used to enabled / disabled the onboard audio CODEC.

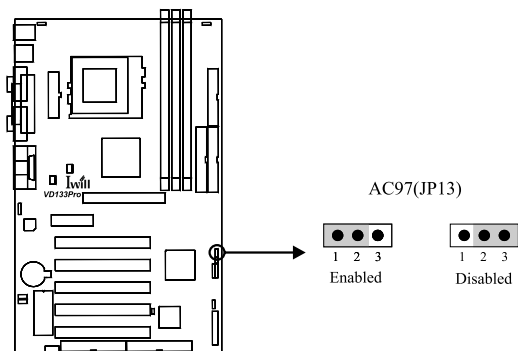

1.3.5 JP70(VD133 Pro only)

This jumper is used to disable/enable the IDE RAID function.No jumper cap is used to disable IDE RAID.

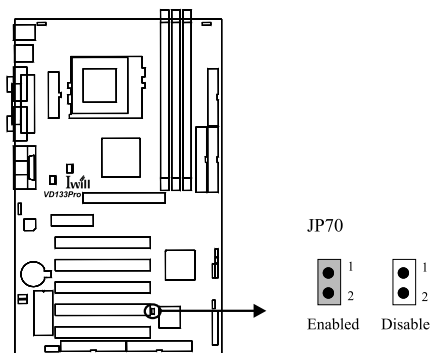

1.4 Expansion Slots / Sockets

1.4.1 J1(Socket 370) Processor socket

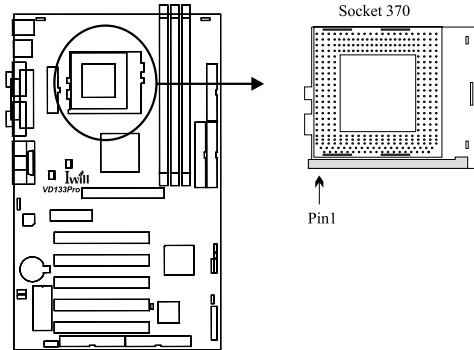

1.4.2 J3—J5 (DM0—DM2) 168-Pin DIMM Sockets

Install memory in any combination as follows:

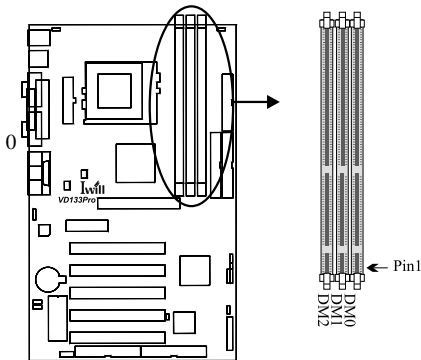

Location	Support Module Type
DM0	Single-Side Module
	Double-Side Module
DM1	Single-Side Module
	Double-Side Module
DM2	Single-Side Module
	Double-Side Module
	Total System Memory (Max1.5 GB)

1.4.3 J12—J16 (PCI 1—PCI 5) PCI expansion slots

The connectors are Bus Master PCI Expansion Slots.

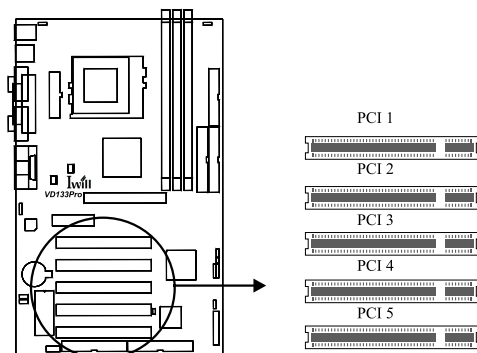

1.4.4 J27 (AMR) AMR Slot

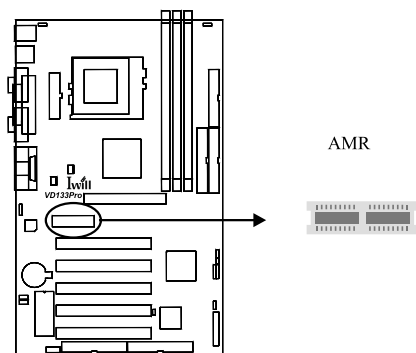

1.4.5 J11 (AGP) AGP Slot

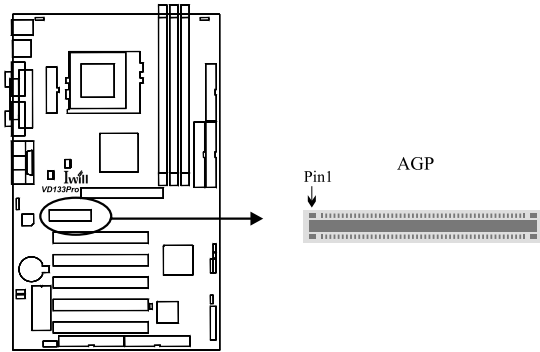

1.5 Connectors

1.5.1 J28 (IDE0) Primary ATA/66 IDE channels

1.5.2 J29 (IDE1) Secondary ATA/66 IDE channels

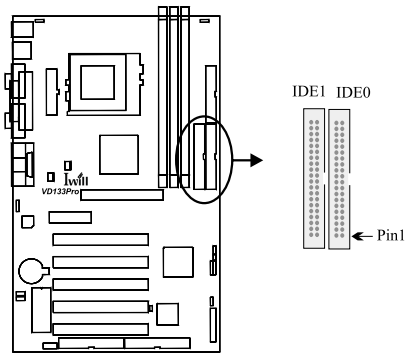

1.5.3 J65(IDE2) The Third ATA/66 IDE channels(VD133 Pro only)

1.5.4 J66(IDE3) The Fourth ATA/66 IDE channels (VD133 Pro only)

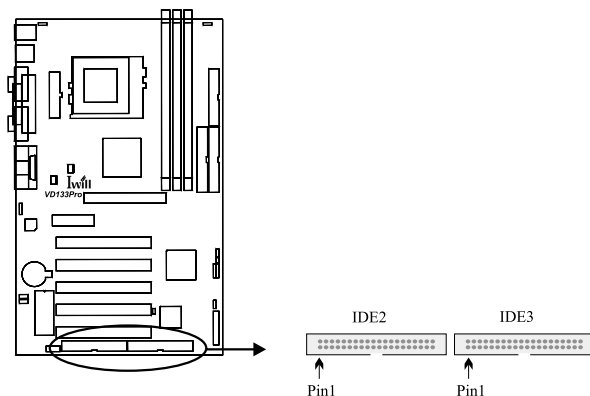

1.5.5 J30 (FDC) Floppy connector

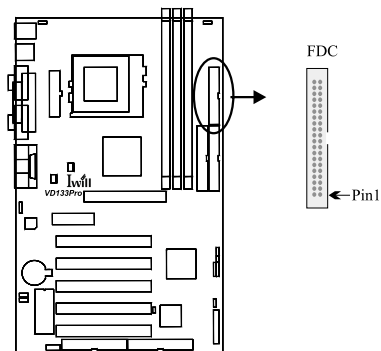

1.5.6 J37 ATX power connector

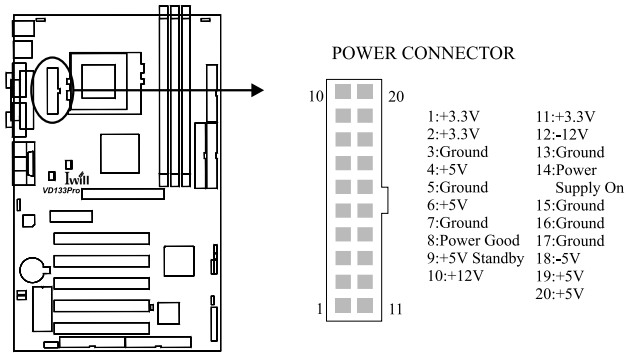

1.5.7 J39(FCPU)&J41(FSYS)

fan connectors on this motherboard. The J39 (FCPU) is designed to support CPU fan; the J41 (FSYS) is for system fan used .

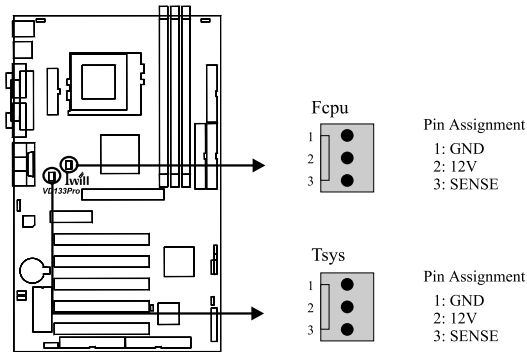

1.5.8 J43

This connector is composed of all the headers that may be connected to the front panel of the chassis.

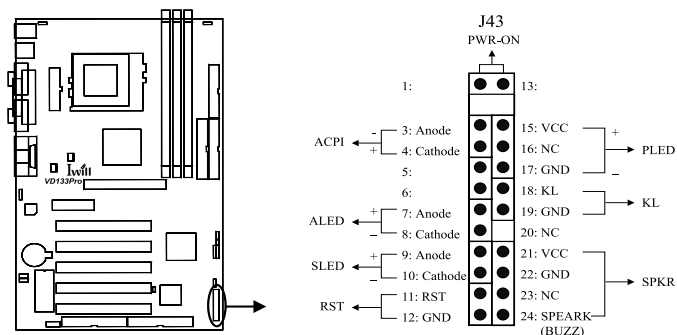

1.5.9 J45 (IR)

This connector is designed for the SIR devices.

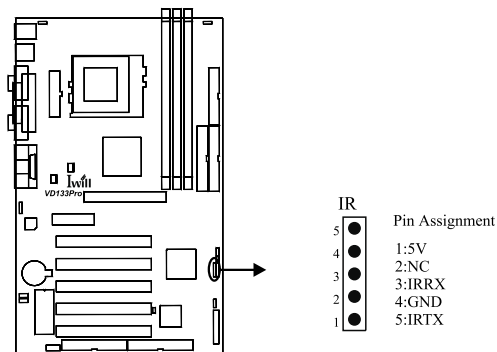

1.5.10 J46 (WOL)

This is the Wake-on-LAN connector. In order to wake up the system through a plug-in network card, the card must provide a high active wake signal.

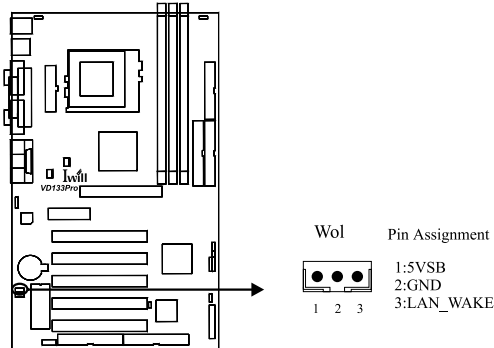

1.5.11 J46(MODEM)

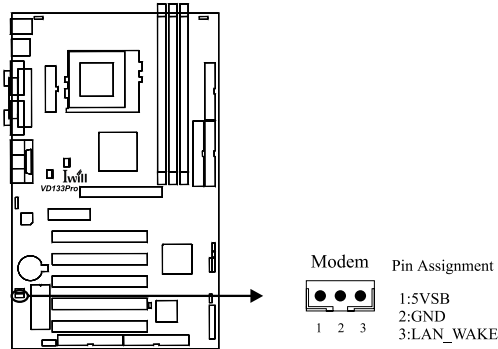

1.5.12 J48(SMBUS)

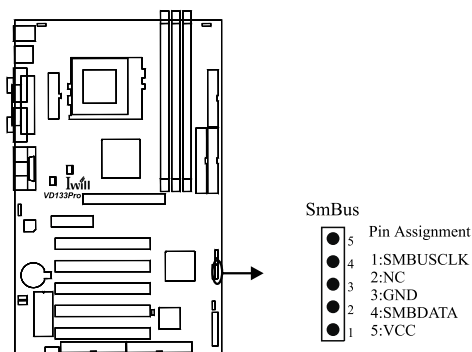

1.5.13 J54 (CD_IN)

The audio output can be transferred from CD-ROM to the audio system

This connector can be connected for mid-to-low speed devices such as mice, keyboards, joysticks,etc.

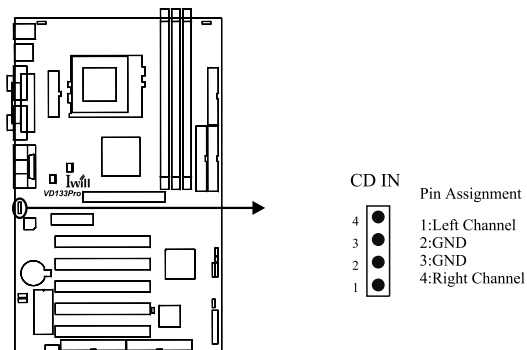

1.5.14 J54A (USB1)

The motherboard provides four USB support for the commonly found USB devices now a days. The motherboard has two USB ports onboard. The extra two USB support can only functionable with the additional USB riser kit.

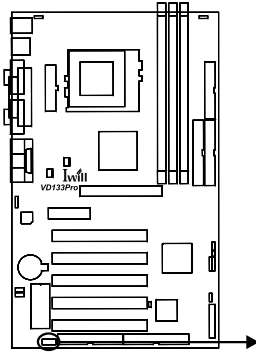

USB1		Pin Assignment	
1	2	1:5V	2:5V
3	4	3:USA DATA-	4:USB DATA-
5	6	5:USA DATA+	6:USB DATA+
7	8	7:GND	8:GND
9	10	9:GND	10:NC

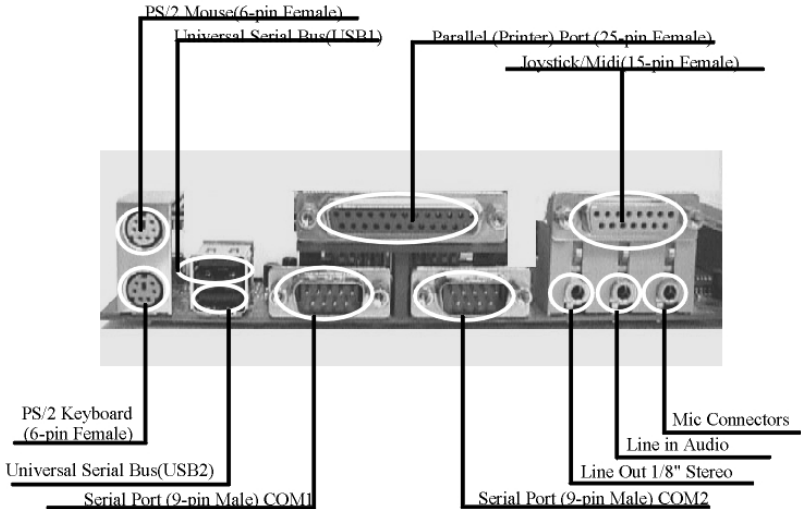

1.6 Form Factor

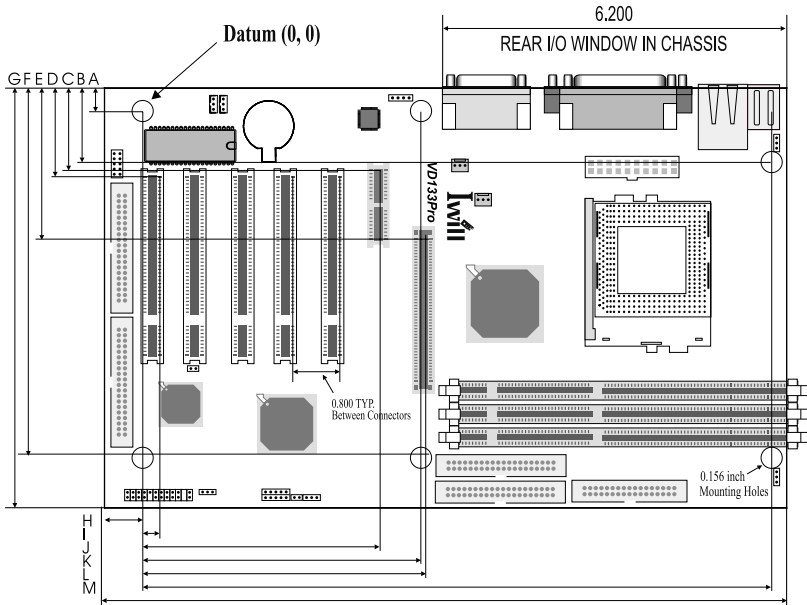

A: 0.400 inch	H: 0.650 inch
B: 0.900 inch	I: 0.320 inch
C: 1.060 inch	J: 4.210 inch
D: 1.230 inch	K: 4.900 inch
E: 2.230 inch	L: 5.000 inch
F: 6.100 inch	M: 11.100 inch
G: 7.400 inch	N: 12.000 inch

Chapter 2

Overview

Thank you for purchasing the IWILL VD133 Pro series motherboard. This operation manual will instruct you how to configure and install the system properly. It contains an overview about the engineering design and features of this product. Also, this manual provides useful information for later upgrades or configuration changes. Keep this for your future reference.

About This Manual

This manual will introduce to the user how this product is installed. All useful information will be described in later chapters. Keep this manual for future upgrades or system configuration changes.

Chapter 1 Quick Installation	The quick reference for experienced user
Chapter 2 Overview	An overview of this motherboard
Chapter 3 Features	Information and specifications
Chapter 4 Hardware Setup	Information for setting up the motherboard
Chapter 5 BIOS Setup	Information for setting up the system BIOS
Chapter 6 Power Installer CD	Information for the Power Installer CD

Item Checklist

You should find the following components when opening the box:

- Iwill motherboard
- This operation manual
- Two 40-pin ATA/66 cable with three heads
- One 34-pin Floppy cable with four heads
- One Iwill Power Installer CD
- Thermal Sensor for System
- One RAID utility CD diskette

Optional

- Thermal Sensor for HDD
- One USB riser kit
- One Infrared port cable
- One Driver Diskette
- Iwill SIDE-RAID66 PCI ATA/66 IDE controller
- Iwill SIDE-2930C PCI Fast SCSI controller
- Iwill SIDE-2930U+ PCI Ultra SCSI controller
- Iwill SIDE-2936UW PCI Ultra Wide SCSI controller
- Iwill SIDE-2935LVD PCI Ultra2 SCSI controller
- Iwill SIDE-DU280 PCI Dual channel Ultra2 SCSI controller
- Iwill SIDE-DU3160 PCI Dual channel Ultra160 SCSI controller
- MR card

Introduction

The VD133Pro motherboard is the most flexible platform in today's market based on the HPT368 chipset support IDE RAID function. A major advancement in chipset technology, VIA 694X chipset support PC66/PC100/PC133 SDRAM. **(VD 133 PL doesn't support IDE RAID function)**

This motherboard supports Intel/Cyrix/Katmai/Cummine processors. It can support the processors that packed as a PPGA or FCPGA type. In other words, no matter what kind of processors you have, the VD133Pro / VD133 PL motherboard always provides you an adequate solution.

What is RAID?

RAID stands for Redundant Array Independent Disk, it was developed by a group of scientists at University of California at Berkeley in 1987. The scientists investigated using small disk drivers clustered into an array and compared the performance and cost of this type of storage configuration to the use of a Single Large Expensive Disk (SLED), commonly found in mainframe application. The conclusion was that arrays of smaller and less expensive disks outperformed the performance of the SLED.

However, disk performance is not the only requirement in today's Information Technology market. As more network storage capacity expands, the more critical it becomes to safely backup the data in the disks. While tape or MO backup meets the recovery requirements, it does not ensure the continuous availability and data integrity necessary to keep your system up and running. To solve this, the scientists proposed five types of redundant array architectures, known as RAID level 1 through 5. Each RAID level defines how redundancy is achieved and data is distributed across the drives in the array.

What is IDE RAID?

RAID was associated with SCSI interface only in the past. The capital outlay generally puts people out of the door. This situation is about to change with the introduction of IWILL VD133 Pro™. A high performance IDE RAID host adapter, with Ultra ATA66 interface. The IDE RAID66™ offers **RAID 0** (Striping), **RAID 1** (Mirroring) and **RAID 0+1** (Striping + Mirroring) functions, and supports the Ultra ATA 33/66 hard disks commonly found in the market today.

Copyright

This manual contains information protected by copyright law. All rights are reserved. No part of this document may be used or reproduced in any form or by any means, or stored in a database or retrieval system without prior written permission from Iwill Corporation.

Trademark

Intel® / Pentium® / Celeron™ are trademarks of Intel Corporation.

Iwill and Iwill logo are trademarks of Iwill Corp.

All other product names are trademarks and registered trademarks of their respective owners.

Warning

Most of the features of this product have passed strict verification tests, and are subject to change at any time without prior notice. If any malfunction occurs due to the future technical changes made by the respective component manufacturers, Iwill assumes no responsibility or liability for it.

Notice

Information furnished in this manual is believed to be accurate and reliable. However, Iwill Corporation assumes no responsibility for its use, nor for any infringements of patents or other rights of third parties which may result from its use. Iwill Corporation reserves the right to change product specifications at any time without notice. Applications described in this document for any of these products are for illustrative purposes only. Iwill Corporation makes no representation nor warranty that such applications are suitable for the specified use without further testing or modification. Iwill Corporation assumes no responsibility for any errors that may appear in this document.

We

IWILL Corporation

No. 10, Wu Chuan 3rd Rd.,

Hsin Chuang City, Taipei,

Taiwan, R.O.C.

Declare under sole responsibility that the

VD133 Pro series motherboard

Meets the intent of Directive 89/336/ECC for Electromagnetic Compatibility. Compliance was demonstrated to the following specifications as listed in the official Journal of the European Communities:

EN50081-1 Emissions:

EN55022 Radiated, Class B

EN55022 Conducted, Class B

EN60555-2 Power Harmonics

EN50082-1 Immunity:

IEC 801-2 Electrostatic Discharge

IEC 801-3 RF Radiate

IEC 801-4 Fast Transient

Chapter 3

Features

This motherboard are well designed for the user. Who wants the most stable plat form, best perform-ance/price ratio and convenience.

3.1 Motherboard Components Placement

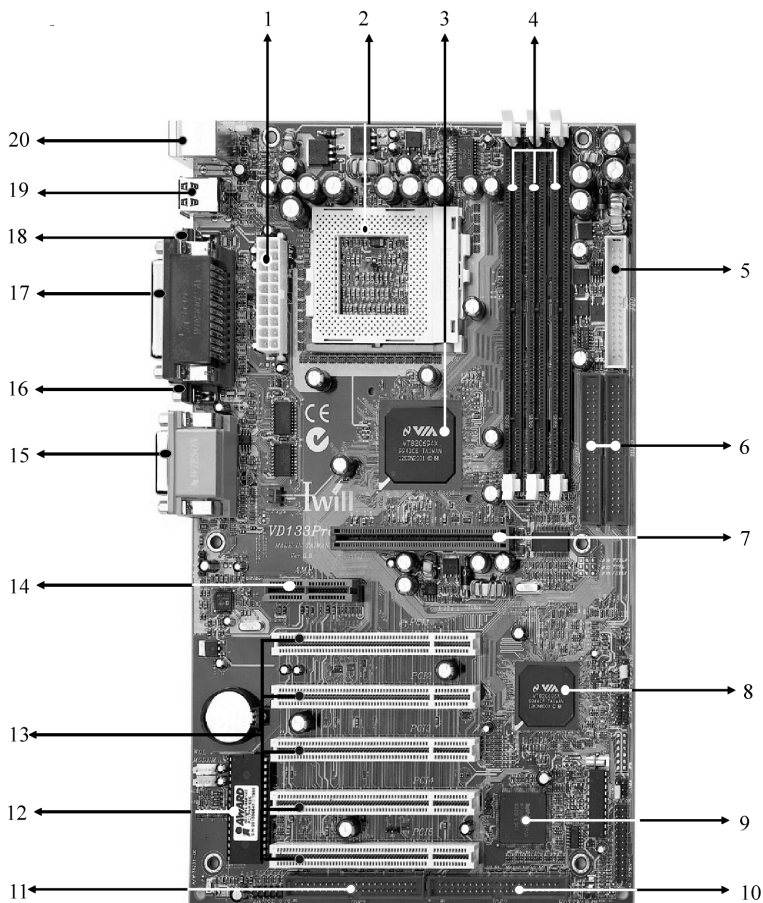

Chapter 3 Features

The following are part descriptions for the motherboard parts shown on the opper page.

- 1: **ATX Power Connector**
- 2: **Socket 370 Connector**
- 3: **VIA 82C694X Chipset**
- 4: **Three DIMM Sockets**
- 5: **Floppy Connector**
- 6: **Primary and Secondary IDE Connectors**
- 7: **AGP slot**
- 8: **VIA 82C686X Chipset**
- 9: **HighPoint HPT368 Chipset (VD133 Pro only)**
- 10: **The Third IDE Connector (VD133 Pro only)**
- 11: **The Fourth IDE Connector (VD133 Pro only)**
- 12: **Programmable BIOS**
- 13: **32bit/33MHz Bus Master PCI Slot**
- 14: **AMR Slot**
- 15: **Joystick, Midi Line Out ,Line in, Microphone In Connector**
- 16: **COM1 Connector**
- 17: **Parallel Connector**
- 18: **COM2 Connector**
- 19: **USB1 Connectors**
- 20: **PS/2 Mouse, PS/2 Keyboard Connector.**

3.2 Back Panel

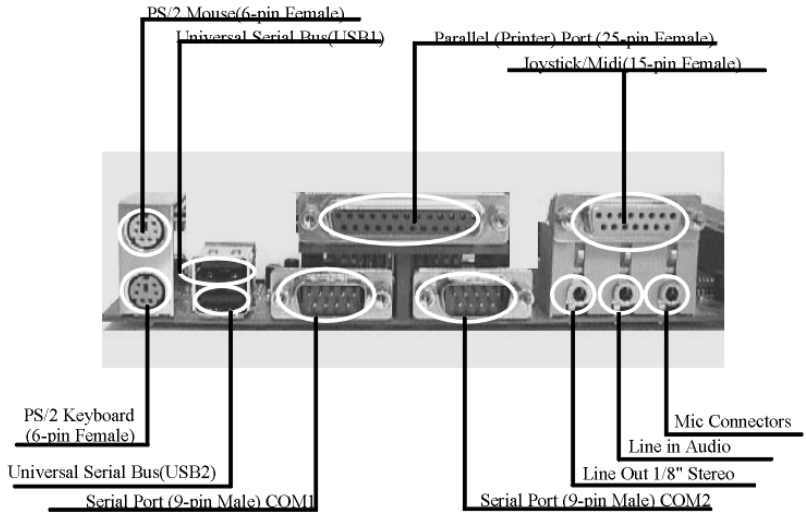

3.3 Block Diagram

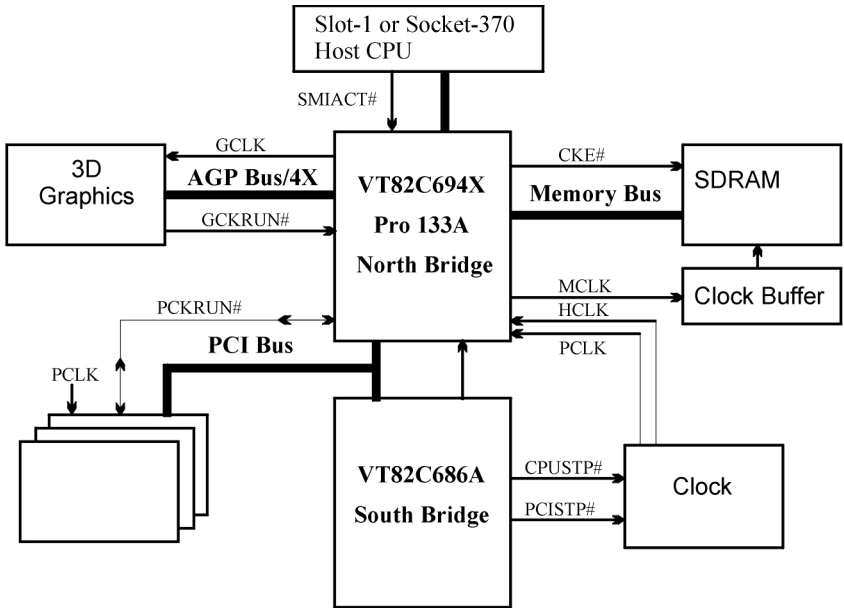

3.4 Specifications

Processor

- Support unique CPU through Socket370 socket (Reserved Socket418 space).
- Support Intel/Cyrix CPU.
- Support Katmai/CuMine CPU.
- Support CPU speed from 300 MHz up to 466 MHz or high.
- Support H/W setting and S/W adjustable (Jumper-free) method.
- Support "Software assign ext. frequency" (All frequency that Clock Gen provided).
- Support "Software assign CPU Multiplier" from 2X to 8X

ChipSet

- VIA Apollo Pro133A
- Support 66/100/133 MHz system Bus Frequency

MainMemory

- Supports three DIMM sockets
- Support PC66/PC100/PC133 SDRAM
- Support 16M/64M/256M/512M SDRAM technology
- Maximum memory up to 1.5GB/768MB when using 256M/64M-16M technology.
- Support Suspend to Ram
- Support 3.3V Unbuffered/Registered DIMM
- Support Singel-Sided/Double-sided DIMMs
- Support ECC memory module

Bus Master IDE

- Supports 2 channel IDE interface up to 4 IDE Devices.
- Supports Ultra DMA Bus Master with 66 MB/s burst data transfer rate.
- Supports PIO mode up to Mode 4.
- Supports LS120/Zip drive.

Multi-IO

- Provides one floppy port to support 1.2M/1.4M/2.8M/3 mode FDD and QIC-80 tape drive
- Supports two high-speed 16550A serial ports
- Supports one ECP/EPP parallel ports
- Supports one PS2 mouse port
- Supports one PS2 keyboard port
- Provides One Game/MIDI port to support two joysticks
- Supports one SIR port
- Supports PS2 mouse and PS2 keyboard

USB

Supports 4 UHCI Universal Serial bus Port

Expansion Slots

Three DIMM sockets

One Universal AGP Slot

Five 32bit/33 MHz Bus Maser PCI Slots

One AMR Slot

One AGP Slot

Sound on board

Support AC'97 2.1 Digital Link

Management

H/W monitoring +5V, Vcore, VTT, Vio Vsb voltage

Supports Power on by Lan/Ext. Modem/Int. Modem/Keyboard/Alarm

Supports ACPI Blinking LED

Supports BIOS ROM Flash Control (S/W protection)

Supports "AC-Loss Recovery"(Former status/OFF)

Supports Suspend to RAM

Supports suspend to Disk

BIOS

Support 2M flash ROM

Support Plug & Play

Supports APM 1.2

Supports DMI 2.1

Supports ACPI 1.0

Year2000 compliance

Others

ATX Form Factor 30.5" x 18.8"

Chapter 4

Hardware Setup

4.1 Before Installation

For installation, you may need some or all of the following tools:

Medium size flat blade screwdriver

Medium size Phillips head screwdriver

A 3/16 inch nut driver or wrench



Users must follow these guidelines to ensure the motherboard is protected during installation.

- a. Make sure your computer is powered-off whenever working with inside components.
- b. The motherboard, like all other electronic equipment, is sensitive to static. Please take the proper precautions when handling it. If possible, ground yourself by touching a metal table or desk. Keep the board in its conductive wrapping until it is configured and ready to be installed in your system.
- c. Keep all magnets away from both your hard and floppy disk drives, especially magnetic screwdrivers. Keep both floppy and hard disks apart if disassembled.
- d. Keep water and liquids away from your computer and its components.

4.2 Jumper setting

4.2.1 JP1 Clear CMOS jumper (CMOS)

To reset the CMOS data, you should turn off the computer first, take the JP1 jumper cap off pins 1-2, place onto pins 2-3, and then place back onto pins 1-2 again. Then, turn on your computer, press key during boot up and enter the BIOS setup program to re-set your preferences.

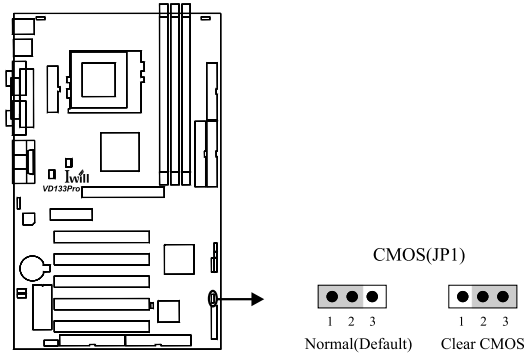

4.2.2 JP9(Vcore+) CPU core voltage select jumper

This function offers adjustable processor Vcore. When NO jumper caps are used, the motherboard automatically generates the proper Vcore voltage that requested by the CPU. Place the jumper cap over pins 1-2 to increase 5% more voltage to the processor's Vcore. Place the jumper cap over pins 2-3 to increase 10% more voltage to the processor's Vcore.

4.2.3 JP10 VIO select jumper (Vio)

This jumper allows you to select the voltage supplied to the DRAM, chipset, PCI and the CPU's I/O buffer. The default voltage should be used unless processor over-clocking requires a higher voltage.

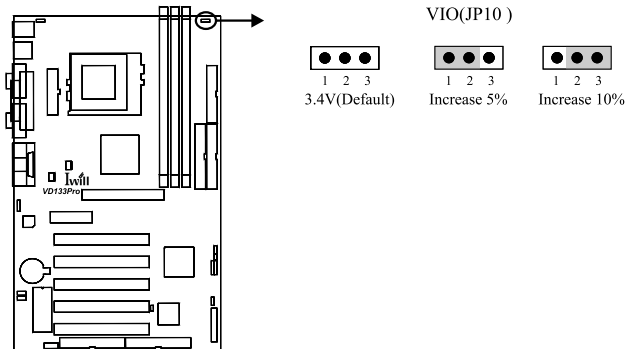



Using a higher voltage may help when over-clocking but may result in the shortening of your computer component's life. It is strongly recommended that you leave these setting on its default.

4.2.4 JP13 AC'97 Codec Enabled / Disabled jumper (AC'97)

This jumper is used to enable / disable the onboard audio CODEC. The onboard audio CODEC must be disabled when using an ISA/PCI audio card or a primary AMR card.

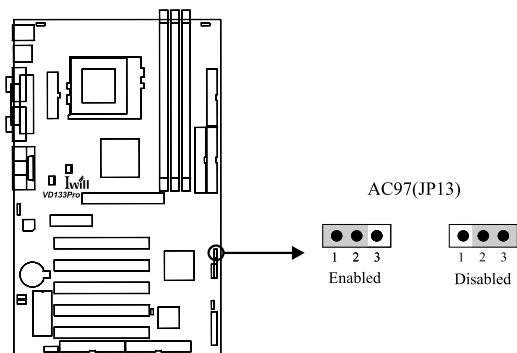

4.2.5 JP70 (VD133 Pro only)

This jumper is used to disable/enable the IDE RAID function. No jumper cap is used to disable IDE RAID.

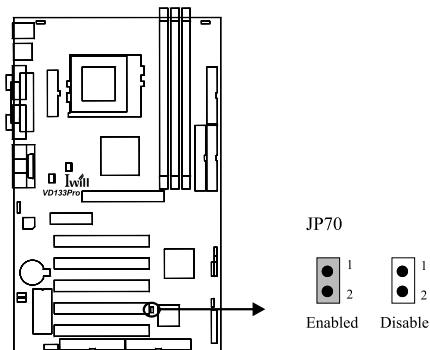

4.3 Install the Processor



The CPU should have a fan attached to it to prevent overheating. If this is not the case, then purchase a fan before you turn on your system.

Be sure that there is sufficient air circulation across the processors heatsink by regularly checking that your CPU fan is working. Without sufficient circulation, the processor could overheat and damage both the processor and the motherboard. You may install an auxiliary fan, if necessary.

The motherboard provides a ZIF Socket 370.

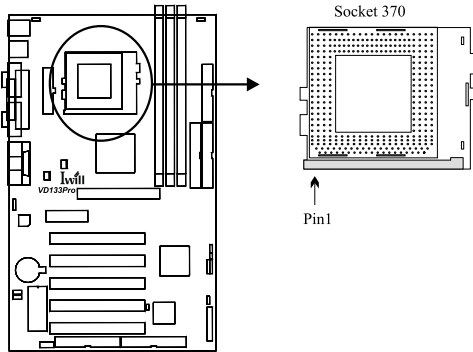

Step1:

Locate the ZIF socket and open it by first pulling the lever of socket upward.

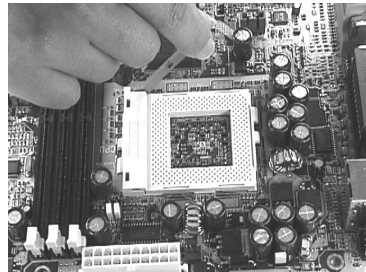
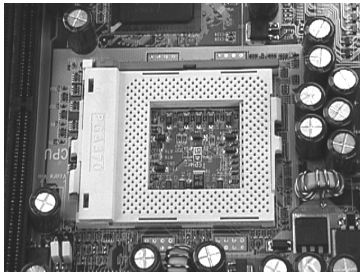

Step2:

Insert the CPU into the socket. Please keep the lever right angle when inserting CPU.

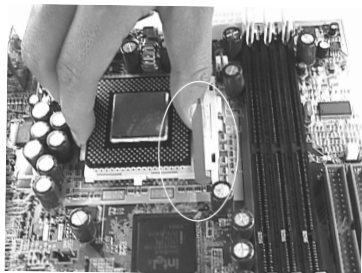

Step3:

When inserting the CPU please note the correct orientation as shown. The notched corner should point toward the end of the lever.



Because the CPU has a corner pin for two of the four corners, the CPU will only fit in the orientation as shown.

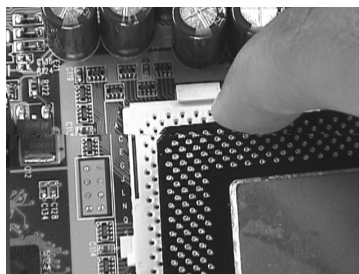
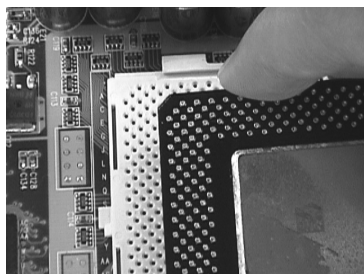

Step4:

Push the lever down to close the socket.

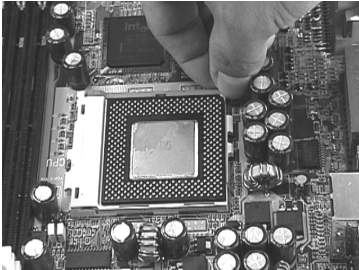
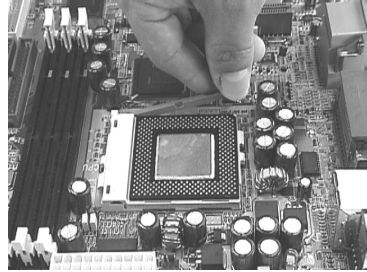
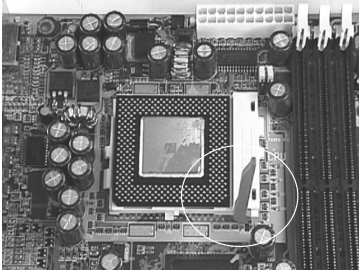

Step5:

Attach the heatsink onto the CPU.



Be careful not to scrape the motherboard when mounting a clampstyle processor fan or else damage may occur to the motherboard.

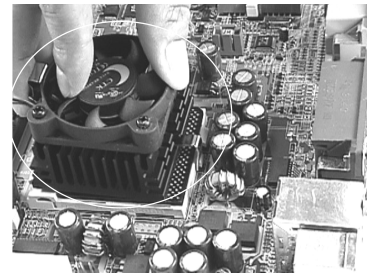
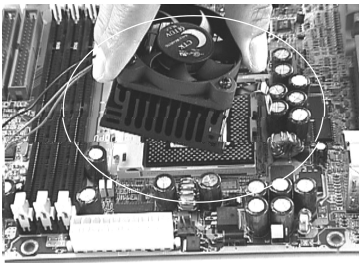

Step6:

Push the clip of heatsink downward to hook the ear of socket firmly.

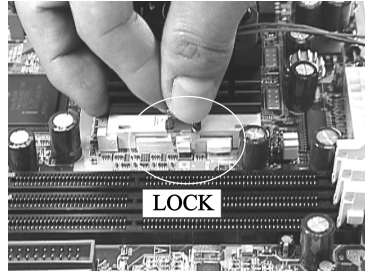
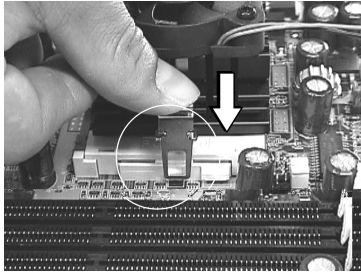

Step7:

Finally, attach the fan cable to the CPU fan header FCPU.

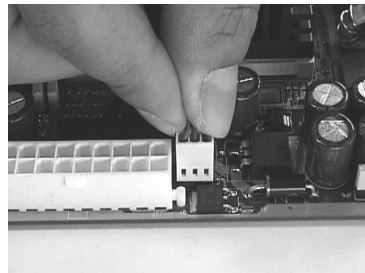
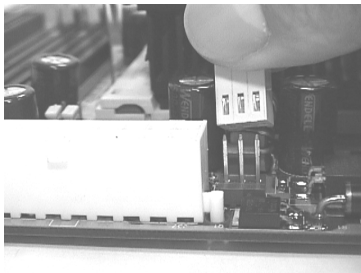

Don't forget to set the correct Bus Frequency and Multiple (frequency multiple setting is available only on unlocked processors) for your Socket 370 processor or else boot-up may not be possible.

4.4 Install Memory Modules

The motherboard has three Dual Inline Memory Module (DIMM) sockets and supports the maximum memory size up to 512MB. These DIMM sockets only support 3.3V unbuffered SDRAM modules of 16M, 32M, 64M, 128M and 256M. The motherboard also support SPD (Serial Presence Detect) architecture to provide the best choice for performance vs. stability.



- 1.The chipset does not support ECC. However, the ECC memory modules may still be used, but the ECC function will not be available.
- 2.No hardware or BIOS setup is required after adding or removing memory modules.

4.4.1 Memory Configuration Table

Location	Support Module Type
DM0	Single-Side Module
	Double-Side Module
DM1	Single-Side Module
	Double-Side Module
DM2	Single-Side Module
	Double-Side Module
Total System Memory (Max1.5 GB)	

Step 1:Open latches of DIMM socket

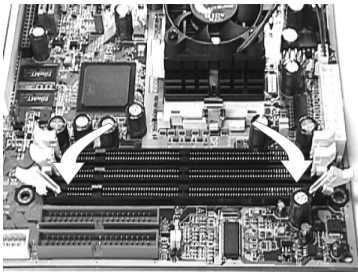

Step 2:Proofread the RAM module to the DIMM Socket

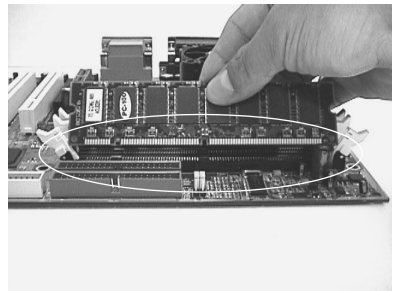

Step 3:Insert the RAM module into the DIMM Socket

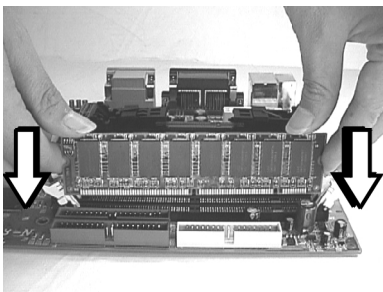

Step 4:Press the latches into the notches of the RAM module

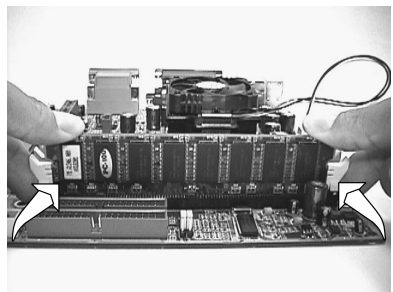

4.5 Install PCI Expansion Cards



Make sure that you have unplugged the power supply before you adding or removing expansion cards or other component. Failure to do so may cause damage to both the motherboard and expansion cards.

This motherboard provides five bus master PCI expansion slots. You can expand the features of the computer by adding some expansion cards. Before you do that, read the documentation for your expansion card carefully and make any necessary hardware settings on it, such as jumpers or switches. Locate a free expansion slot and remove the bracket plate with screw on the slot you intend to use, carefully align the card's connectors, press it firmly and secure the card on the slot with the screw you remove above. After installing the necessary software drivers, you can enjoy the features that expansion card provided.



In the PCI bus design, the BIOS automatically assigns an IRQ to a PCI slot that has a card in it. To check the IRQ map of your system in Windows 98, the Control Panel icon in My Computer contains a System icon, which gives you a Device Manager tab. Double click on a specific hardware device gives you the Resource tab, which shows the IRQ and address. Make sure that no two devices use the same IRQ or your computer will experience problems. If your expansion card must be performed with a specific IRQ, you can enter BIOS setup program to assign the specific IRQ in PnP/PCI Configuration page.

4.6 Usage of the AMR slot

This motherboard provides a Audio Modem Riser (AMR) slot to support a specially designed audio and/or modem card called an AMR card. Main audio and/or modem processing is done by system processor to provide an upgradeable audio and/or modem solution at an incredibly low cost.

There are two type of AMR card, one defined as primary and another defined as secondary. This motherboard uses the primary channel so that a secondary AMR card can coexist without the need to disable the onboard audio CODEC. The onboard audio CODEC must be disabled when using a primary AMR card.

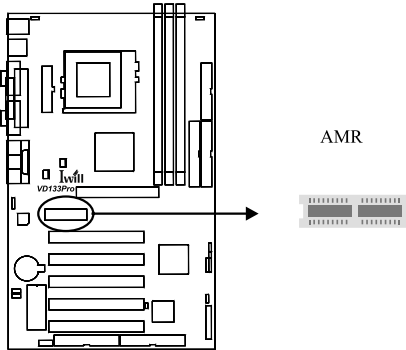

4.7 Usage of the AGP slot

The Accelerated Graphics Port (AGP) is a high-performance bus, especially for graphic-intensive 3D applications. AGP is independent of the PCI bus, and is intended for exclusive use with graphics devices.

The most important feature of AGP is DIME (Direct Memory Execute). DIME needs to allocate some system memory via the OS to access large textures outside the local graphic memory of the card. In order to take advantage of the DIME feature, some software components should be installed or upgraded within your system.

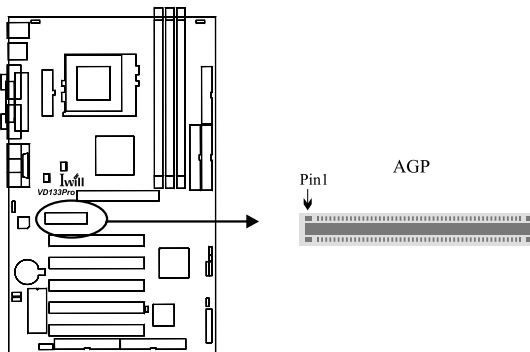

4.8 Connect Devices and Power Supply



All the connectors showed in this section are not jumpers, **DO NOT PLACE JUMPER CAPS OVER THE PINS OF THEM.** If you do so, you will damage the motherboard permanently.

4.8.1 Primary / Secondary IDE Connectors (IDE0 / IDE1)

This motherboard provides four independent Ultra ATA/66 IDE channels, which doubles the ATA/33 burst data transfer rate to 66 MB/s and are 100 percent backward compatible with all existing ATA / ATAPI devices. These connectors also support ZIP and LS-120 devices.

The ATA/66 requires a special 40-pin, 80-conductor cable that reduces noise bleed-over and improves signal integrity by providing 40 additional ground lines between each of the standard 40-pin ATA (IDE) signal lines and ground lines. Although a new 40-pin, 80-conductor cable is required for Ultra ATA/66, the chipset pin connector remains the same at 40.



The 40-pin, 80-conductor cables will support the Cable Detect feature. The blue (end) connector should be connected to the system board. The black (end) connector is known as the master position. The gray (middle) connector can be used for slave devices.

A legacy ATA (IDE) drive can coexist with an Ultra ATA/66 drive. However, for the Ultra ATA/66 device to attain Ultra DMA 4 mode, an Ultra ATA/66 capable cable is required.



Orient the red markings on the ribbon cable to pin1 of the connector

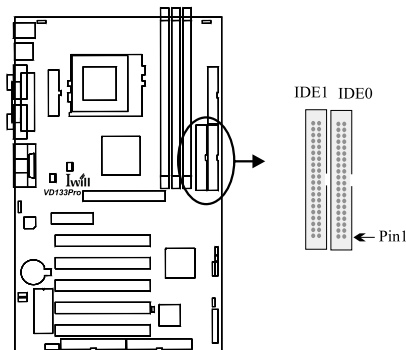

4.8.2 The third/The fourth IDE Connectors (IDE2/ IDE3) (VD133 Pro only)



Orient the red markings on the ribbon cable to pin1 of the connector

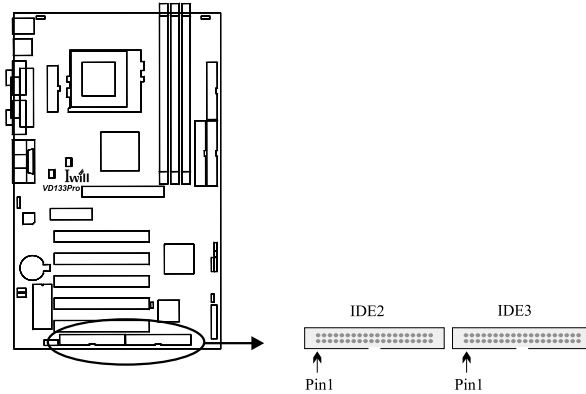

4.8.3 Floppy Connector (FDC)

This motherboard has one floppy connector to support 360K, 720K, 1.2M, 1.44M, 2.88M, 3 Mode floppy drives and QIC-80 floppy tape drive. After connecting the single end to the board, connect the two plugs on the other end to the floppy devices.



Orient the red markings on the ribbon cable to pin1 of the connector

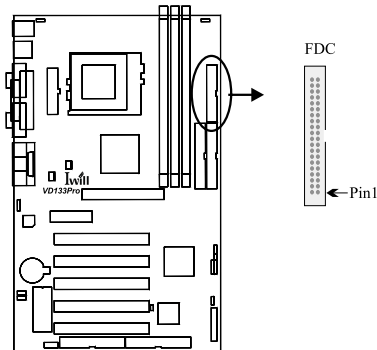

4.8.4 Back Panel

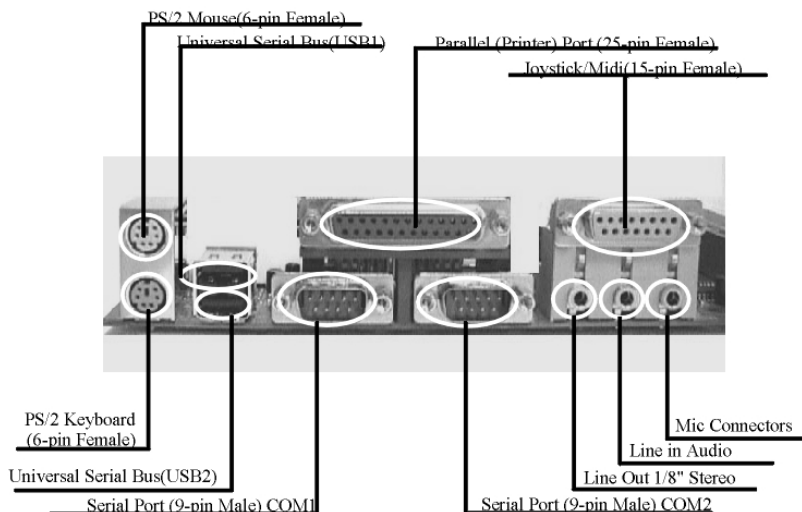

4.8.4.1 PS/2 Mouse Connector (Green color)

This connector can be used to support a PS/2 mouse.

4.8.4.2 PS/2 Keyboard Connector (Purple color)

This connector can be used to support a PS/2 keyboard.

4.8.4.3 Universal Serial Bus Connectors

This motherboard has two USB ports, any USB-compatible peripherals and/or hub can be connected into either USB port.



The PS/2 mouse and PS/2 keyboard can be auto-detected by this motherboard. That means if you plug the PS/2 keyboard into the mouse connector, it still can work without any trouble and vice versa. It is recommended that you turn off the computer before connecting or disconnecting keyboard and/or mouse.

4.8.4.4 Serial port COM1&COM2 Connector (Teal color)

One serial port is ready for a modem or other serial devices. A second serial port is available using a serial port bracket connected from the motherboard to an expansion slot opening.

4.8.4.5 Parallel port Connector (Burgundy color)

This connector is used for printers, or other parallel devices.

4.8.4.6 Joystick/Midi and Audio Port Connector (Gold color)

You may connect joysticks or game pads to this connector for playing games, or connect MIDI devices for playing / editing professional audio. Line Out (Lime color) can be connected to headphones or powered speakers. Line In (Light Blue color) allows audio sources to be recorded by your computer or played through the Line Out connector. Mic (Pink color) allows microphones to be connected for inputting voice. network hub.

4.8.5 CPU and System FAN Connectors (FCPU and Fsys)

There are two fan connectors on this motherboard. The J39 (FCPU) is designed to support CPU fan; the J41 (Fsys) is for system fan. Depending on the fan manufacturer, the wiring and plug may be different. In most of the case, the red wire is positive, while the black is ground. Connect the fan's plug to the board taking into consideration the polarity of the connector.

The "Sense" signal is to be used only by a specially designed fan with rotation signal. You may use the hardware monitoring utility to monitor the Rotations per Minute (RPM) of the fan.

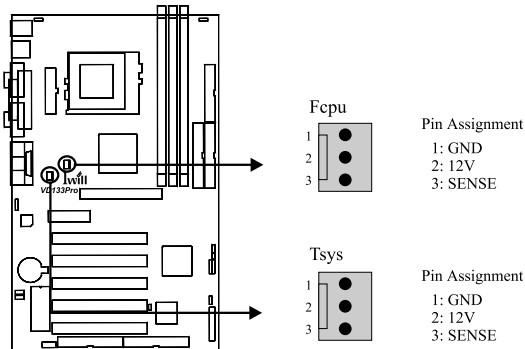

1. The CPU will overheat if there is no airflow across the CPU heatsink.
2. Damage may occur to the CPU fan and/or motherboard if these pins are incorrectly used.

4.8.6 Front Panel Connector (J43)

This connector is composed of all the headers that may be connected to the front panel of the chassis.

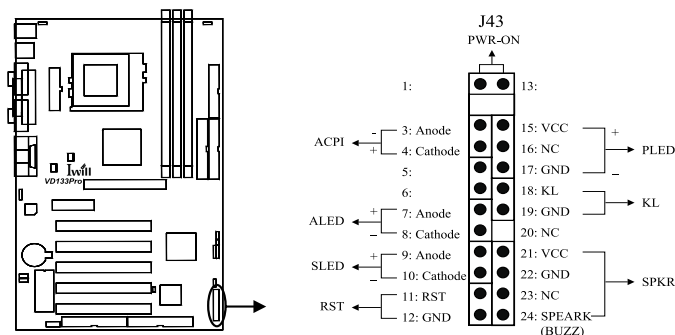

4.8.6.1 Power/Soft-Off Connector (PWR_ON)

The system power is controlled by a momentary button connected to this connector. Pressing the button once will switch the system between ON and OFF. Pushing the button for more than 4 seconds will turn the system off.

4.8.6.2 ACPILED Connector (ACPI)

This 2-pins connector is for a ACPI power status indicator. The LED status will depend on the connector.

4.8.6.3 IDELED Connector (ALED)

This 2-pin connector connects to the case-mounted IDE LED, which lights when the IDE devices connected to the primary / secondary IDE connectors are working.

4.8.6.4 Reset Connector (RST)

This 2-pin connector connects to the case-mounted reset button for rebooting your computer without having to turn off the power supply.

4.8.6.5 System Power LED Connector (PLED)

This 3-pin connector connects to the case-mounted system power LED, which lights when the system is powered on.

4.8.6.6 Speaker Connector (SPKR)

This 4-pin connector connects to the case-mounted speaker.

4.8.7 Infrared Connector (IR)

This connector supports an optional wireless transmitting and receiving infrared device when using the appropriate application software.

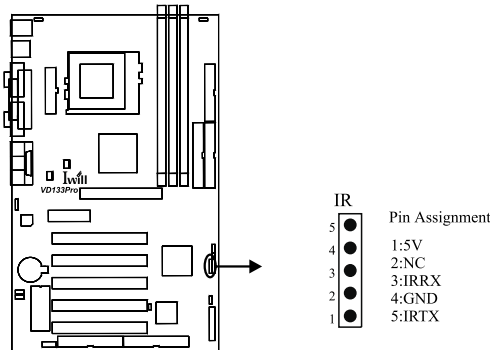

4.8.8 Wake-On-LAN Connector (WOL)

This connector connects to a plug-in network card, which supports the WOL technology to powers up the system when a wakeup packet or signal is received through the LAN card.



- a. You may need to enable the “Wake Up by Ring/LAN” feature in the BIOS setup program.
- b. Your system must have a ATX power supply with at least 720mA 5VSB power.
- c. This motherboard only supports the LAN card with a high-active wake signal.

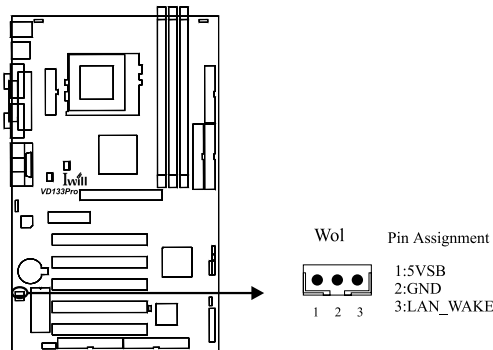

4.8.8 Internal Modem connector (MODEM)

This connection works in conjunction with your modem card. If you intend to use a modem card (inserted into the PCI slot), please connect the cable from the modem card into the Modem header.

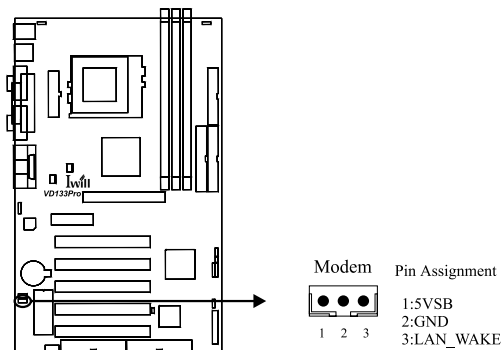

4.8.10 SMBUS connector J48 (SMBUS)

This connector provides the connectivity of SMBUS utilization.

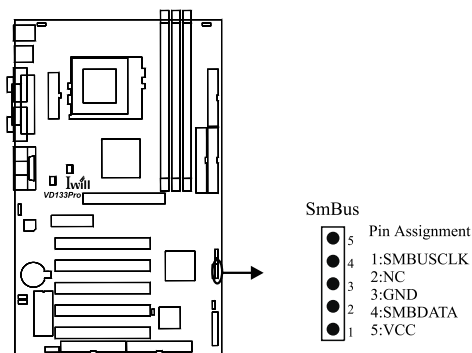

4.7.11 Internal Audio Connector (CD_IN)

This connect allow you to receive stereo audio input from such sound sources as a CD-ROM, TV tuner or MPEG card.

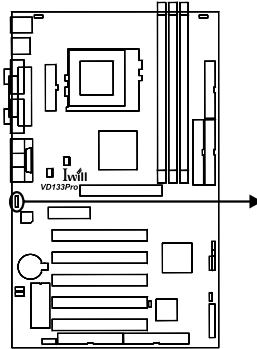

CD IN		Pin Assignment
4	●	1:Left Channel
3	●	2:GND
2	●	3:GND
1	●	4:Right Channel

4.8.12 USB 1

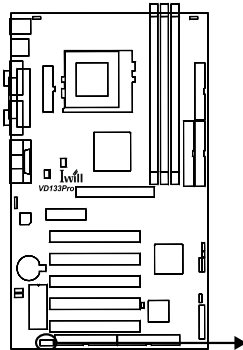

USB1		Pin Assignment
1	●	1:5V
2	●	2:5V
3	●	3:USA DATA-
4	●	4:USB DATA-
5	●	5:USA DATA+
6	●	6:USB DATA+
7	●	7:GND
8	●	8:GND
9	●	9:GND
10	●	10:NC

4.8.13 ATX Power Supply Connector

This connector connects to the ATX power supply. The plug from the power supply will only insert in one orientation because of the different hole sizes.



In order to support the power up function other than power/soft-off button, such as Wake-On-LAN, Wake-On-Modem, your ATX power supply must supply at least 720mA 5VSB.

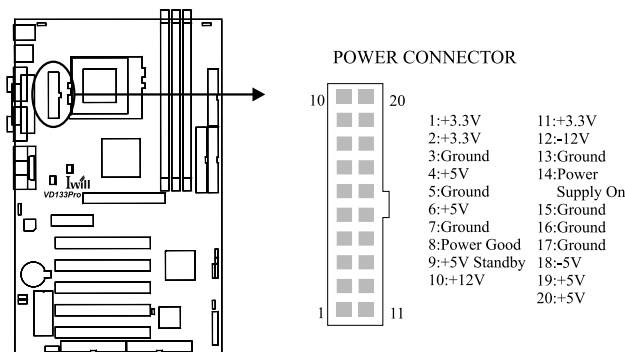

4.8.14 Power On Procedures

- 4.8.14.1 After all connections are made, close the system case over.
- 4.8.14.2 Be sure that all switches are off.
- 4.8.14.3 Connect the power cord into the power supply located on the back of your system case (please refer to the manual of your power supply).
- 4.8.14.4 Connect the power cord into a power outlet that is equipped with a surge protector.
- 4.8.14.5 Many of the power supply support 110V/220V by a switch setting. Switch your power supply to the correct supply voltage (refer to the power supply's manual).
- 4.8.14.6 Turn on your system in the following order:
 - (1) The monitor.
 - (2) The external devices.

- (3). The computer system.

The power LED on the front panel of the chassis will light. After few seconds, the system will then run power-on tests. Some additional messages will appear on the screen during the test. If you do not see anything within 30 seconds from the time you turn on the power, the system may have failed a power-on test. Recheck the jumper settings and connections or call your retailer for assistance.

4.8.15 Power Off Procedures

- 4.8.15.1 Exit from all the software applications.
- 4.8.15.2 Shut down your operating system.
- 4.8.15.3 Switch off the power button. If you are using Windows 95/98, the power supply should turn off automatically after Windows shut down
- 4.8.15.4 Turn off all the external devices.
- 4.8.15.5 Turn off your monitor.

Chapter 5

BIOS Setup

5.1 Introduction

The motherboard uses AWARD BIOS, which is stored in flash memory and can be upgraded using the appropriate software program. The setup program is for viewing and changing the BIOS setting for a computer. These settings are stored in battery-backed RAM so that it retains all the settings after the power has been turned off.

5.1.1 Upgrade BIOS

The BIOS can be upgraded from a diskette with the Award Flash utility — AWDFLASH.EXE. The BIOS image file, and update utility are available from IWILL's WEB site: www.iwill.net

5.1.2 Enter BIOS setup program

Power-on the system by either pressing the Power-On button, or by using any of the power-on features provided by the motherboard. Then, press the key after the Power-On Self Test (POST), and before the scanning of IDE devices. Simply look for the message “Press DEL to enter SETUP” displayed at the bottom of the screen during the boot up process. If the message disappears before you’ve had a chance to respond, you can restart the system by

Turning off the system power then turn it on again, or

Pressing the “RESET” button on the system case, or

Pressing <Ctrl>, <Alt> and keys simultaneously.

5.1.3 Using BIOS setup program

The following table shows the function keys available for each menu screen.

↑Up	Move to the previous field
↓Down	Move to the next field
←Left	Move to the field on the left hand side
→Right	Move to the field on the right hand side
<Esc>	Quit from setup program without saving changes, or Exit from current menu page and return to main menu page
<PgUp> or <+>	Select the previous value for a field
<PgDn> or <->	Select the next value for a field
<F1>	General Help
<F2>	Item Help
<F5>	Previous Values
<F6>	Fail-Safe Defaults
<F7>	Optimized Defaults
<F10>	Save the current value and exit setup program



Generally, the BIOS default settings have been carefully chosen by the system manufacturer to provide the absolute maximum performance and reliability. It is very dangerous to change any setting without full understanding. We strongly recommend that you

DO NOT update your BIOS if the system works perfectly.
DO NOT change any setting unless you fully understand what it means.

If the system does not work smoothly after changing the BIOS settings, follow the procedures described previously, enter the BIOS setup program, then load the original manufacturer default settings.

If the system is no longer able to boot after changing the settings, the only way to recover it is to clear the data stored in RTC CMOS. To reset the RTC CMOS data, take the JP1 jumper cap off pins 1-2, place onto pins 2-3, and then place back onto pins 1-2 again. This will return the RTC to the default setting. Then, get into the BIOS setup program, choose Load Fail-Safe Defaults; Load Optimized Defaults, and select the original manufacturer default settings in your CMOS.

5.2 Main Menu

The main menu allows you to select from several setup pages. Use the arrow keys to select among these pages and press <Enter> key to enter the sub-menu. A brief description of each highlighted selection appears at the bottom of the screen.

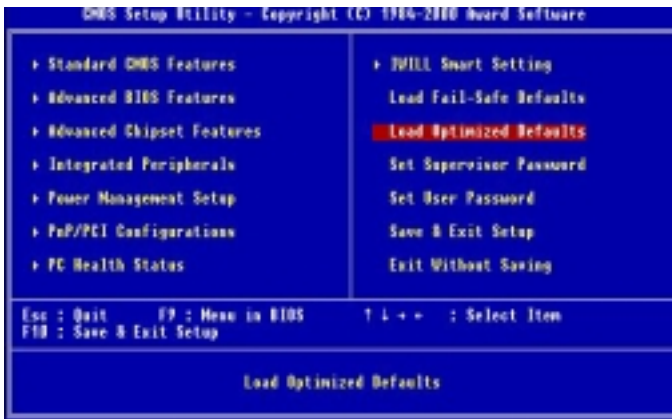

5.3 Standard CMOS Features

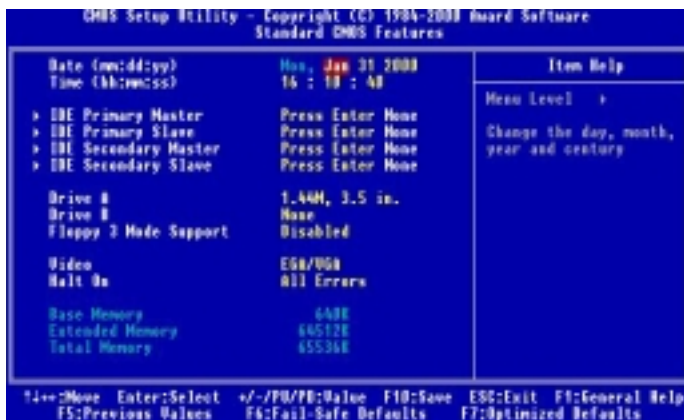

5.3.1 Date

This field specifies the current date. The date format is <month>, <day>, and <year>.

5.3.2 Time

This field specifies the current time. The time format is <hour>, <minute>, and <second>. The time is calculated based on the 24-hour (military-time) clock.

5.3.3 IDE Primary Master / Primary Slave / Secondary Master / Secondary Slave

Press “Enter” to enter next page for detail hard drive setting.

5.3.3.1 IDE HDD Auto-Detection

Auto-Detect the HDD’s Capacity, and its parameters, ex: Cylinder, Head and Sector.

5.3.3.2 IDE Primary Master / Primary Slave / Secondary Master / Secondary Slave

This field specifies type of drive that corresponds to the drive installed in your system. If you select User, please specify the correct number of Cylinders, Heads, and Sectors.

Options	Description
Manual	Selecting ‘manual’ lets you set the remaining fields on this screen. Selects the type of fixed disk.
Auto (*)	BIOS automatically fills in the values for the cylinders, heads and sectors fields
None	Any Disk Drives are attached

5.3.3.3 Capacity Auto Display your disk drive size

- 5.3.3.4 Access MODE
This field specifies the IDE translation mode.
- | Options | Description |
|----------------|---|
| NORMAL | Specifies traditional CHS addressing mode |
| LARGE | Specifies extended CHS translation mode |
| LBA | Specifies LBA translation mode |
| AUTO(*) | BIOS specifies translation method automatically |
- 5.3.3.5 Cylinders
Set the number of cylinders for this hard disk.
- 5.3.3.6 Heads
Set the number of read/write heads
- 5.3.3.7 Precomp
Setting a value of 65535 means no hard disk
- 5.3.3.8 Sectors
Set the number of sectors per track

5.3.4 Drive A / Drive B

This field specifies the traditional type of floppy drives.

Options	Description
None	any floppy drive is connected
(*Drive B default)	
360K, 5.25 in.	A 360K floppy drive is connected
1.2M, 5.25 in.	A 1.2M floppy drive is connected
720K, 3.5 in.	A 720K floppy drive is connected
1.44M, 3.5 in.	A 1.44M floppy drive is connected
(*Drive A default)	
2.88M, 3.5 in.	A 2.88M floppy drive is connected

5.3.5 Floppy 3 Mode Support

3 Mode floppy drive is a type of 3.5-inch drive used by NEC PC98 computers. It supports both 1.2M and 1.44M formats using the same drive. This field specifies which drive supports 3 Mode. When a floppy drive is specified to support 3 Mode, the respective drive setting in "Drive A / Drive B" field will be invalid.

Options	Description
Disabled (*)	No 3 Mode drive is connected
Drive A	A 3 Mode drive is connected as drive A
Drive B	A 3 Mode drive is connected as drive B
Both	Both drive A and drive B are 3 Mode drives

5.3.6 Video

This field specifies the type of the graphics adapters used by the primary system monitor.

Options	Description
EGA/VGA(*)	Specifies EGA or VGA adapter
CGA 40	Specifies CGA adapter with 40 column mode
CGA 80	Specifies CGA adapter with 80 column mode
MONO	Specifies Monochrome adapter

5.3.7 Halt On

This field determines how the system reacts to errors once detected.

Options	Description
All Errors (*)	Each time the BIOS detects a non-fatal error, the system will stop and display an error message
No Errors	The system will stop for any errors that are detected
All, But Keyboard	The system will stop for any errors except keyboard error
All, But Diskette	The system will stop for any errors except diskette error
All, But Disk/Key	The system will stop for any errors except diskette and keyboard errors

5.3.8 Base Memory

The POST (Power-On Self Test) determines the amount of base (conventional) memory installed in the system. The value of the base memory is typically 640K. This field has no options.

5.3.9 Extended Memory

The BIOS determines how much extended memory is present during the POST. This is the amount of memory located above 1MB in the processor's memory address map. This field has no options.

5.3.10 Total Memory

Displays the total memory available in the system

5.4 Advanced BIOS Features



An asterisk (*) denotes the default setting, whenever appropriate.

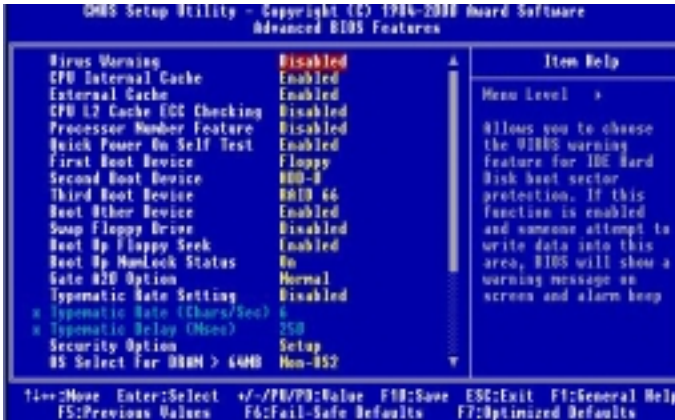

5.4.1 Virus Warning

When this function is enabled, the BIOS monitor the boot sector and partition table of the hard disk drive for any attempt at modification. If an attempt is made, the BIOS will halt the system and then display an error message. Afterwards, if necessary, you can run an anti-virus program to locate and remove the problem before any damage is done.

Many disk diagnostic programs will attempt to access the boot sector table, which can cause the above warning message. If you run such a program, we recommend that you first disable the Virus Warning function beforehand.

Options **Enabled**
 Disabled (*)

5.4.2 CPU Internal Cache

This field configures the CPU internal cache (L1 cache).

Options **Enabled (*)**
 Disabled

5.4.3 External Cache

This field configures the system's external cache (L2 cache).

Options **Enabled (*)**
 Disabled

5.4.4 CPU L2 Cache ECC Checking

This field specifies whether the CPU L2 cache supports ECC or not.

Options **Enabled**
 Disabled (*)

5.4.5 Processor Number Feature

Intel® Pentium® III processors are equipped with a built-in processor serial number for security purposes. When enabled, you allow reading access to this serial number.

Options **Enabled**
 Disabled (*)

5.4.6 Quick Power On Self Test

This field allows the system to skip certain tests while booting. This will decrease the time needed to boot the system.

Options **Enabled (*)**
 Disabled

5.4.7 First / Secondary / Third / Other Boot Device

The BIOS attempts to load the operating system from the devices in the sequence selected in these items.

Options **Floppy (*)**
 LS/ZIP
 HDD-0 ()**
 SCSI
 CD-ROM
 HDD-1
 HDD-2
 HDD-3
 LAN
 RAID66 (*) (VD133 Pro only)**
 Disable



There is a bootable function from HPT368 on this motherboard.

5.5.8 Boot Other Device

Select your boot device priority.

Options **Enabled(*)**
 Disabled

5.4.9 Swap Floppy Drive

When enabled, floppy drives A and B will be exchanged without the user physically changing the connection on the cable.

Options **Enabled**
 Disabled (*)

5.4.10 Boot Up Floppy Seek

Seeks disk drives during boot up. Disabling speeds boot up.

Options **Enabled(*)**
 Disabled

5.4.11 Boot Up NumLock Status

This field determines the configuration of the numeric keypad after system boot up. If On, the keypad uses numbers keys. If Off, the keypad uses arrow keys.

Options	Description
On (*)	Keypad works as number keys
Off	Keypad works as arrow keys

5.4.12 Gate A20 Option

This field configures how the gate A20 is handled. The gate A20 is a device used to address memory above 1 MB. At first, the gate A20 was handled from a pin on the keyboard. While some keyboards still provide this support, it is more common, and much faster, for modern system chipsets to provide support for gate A20.

Options	Description
Fast	support by core logic
Normal(*)	Disable

5.4.13 Typematic Rate Setting

This field determines if the typematic rate is to be used. When enabled, the BIOS will report (after a moment) that the key has been depressed repeatedly. When disabled, the BIOS will report only once if a key is held down continuously. This feature is used to accelerate cursor movements using the arrow keys.

Options **Enabled**
 Disabled (*)

5.4.14 Typematic Rate (Chars/Sec)

When Typematic Rate Setting enabled, this field specifies how many characters will be displayed in one second when a key is held down continuously.

Options **6 (*), 8, 10, 12, 15, 20, 24, 30**

5.4.15 Typematic Delay (Msec)

When enabled, typematic delay allows you to select the time delay between when the key is first pressed and when the acceleration begins.

Options **250 msec (*), 500 msec, 750 msec, 1000 msec**

5.4.16 Security Option

This field configures how the system security is handled. It works conjunction with SETTING SUPERVISOR / USER PASSWORD page to control the security level of the system.

Options Description
Setup (*) System needs a password to enter BIOS setup program
System System needs a password to boot

5.4.17 OS Select for DRAM >64MB

When enabled, this field allows you to access the memory that is over 64MB under OS/2.

Options **OS/2**
 Non-OS/2 (*)

5.4.18 Report No FDD For WIN 95

For a floppy diskless system that runs Windows 95, this field should be set to Yes.

Options **Yes**
 No (*)

5.4.19 Video BIOS Shadow

When enabled, the video BIOS will be copied to system memory and increase the video speed.

Options **Enabled(*)**
 Disabled

5.4.20 C8000-CBFFF / CC000-CFFFF / D0000-D3FFF Shadow D4000-D7FFF / D8000-DBFFF / DC000-DFFFF Shadow

When enabled, the extended ROM data located at the respective address range will be copied to system memory.

Options **Enabled**
 Disabled(*)

5.5 Advanced Chipset Features

This setup page is used to specify advanced features available through the chipset. The default settings have been chosen carefully for most operating conditions. DO NOT change the value of any field in this setup page without full understanding.

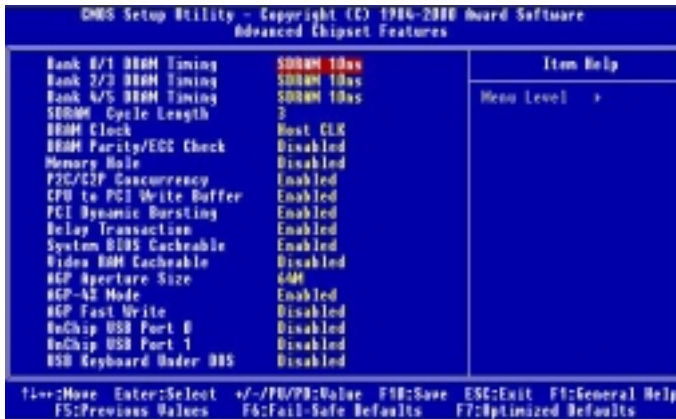

DRAM Settings

The first chipset settings deal with CPU access to dynamic random access memory (DRAM). The default timings have been carefully chosen and should only be altered if data is being lost. Such a scenario might well occur if your system had mixed speed DRAM chips installed. Longer delays might result, however this preserves the integrity of the data held in the slower memory chips.

5.5.1 Bank 0/1 2/3 4/5 DRAM Timing

This item allows you to select the value in this field, depending on whether the board has paged DRAMs or EDO (extended data output) DRAMs.

Some engineering knowledge is needed prior to handling Auto Configuration.

Options **SDRAM 10ns (*) / SDRAM 8ns / Normal / Medium / Fast / Turbo**

5.5.2 SDRAM Cycle Length

When synchronous DRAM is installed, the number of clock cycles of CAS latency depends on the DRAM timing. Do not reset this field from the default value specified by the system designer.

Options	Description
2	2 system clocks
3 (*)	3 system clocks

5.5.3 DRAM Clock

This field allows you to select the DRAM operating frequency to get better performance.

Options Description

Host Clk (*) DRAM clock is the same speed as Front Side Bus
(66/100/133MHz)

HCLK-33MHz DRAM clock is set 33 MHz **less** than the Front Side Bus

HCLK+33MHz DRAM clock is set 33 MHz **greater** than the Front Side Bus

5.5.4 DRAM Parity / ECC Check

When enabled, the BIOS will use ECC (Error Checking and Correcting) protocol to increase integrity of system data. All memory modules used in the system need to support ECC in order for this function to work properly.

Options **Enabled**
 Disabled (*)

5.5.5 Memory Hole

In order to improve performance, certain space in memory is reserved for ISA cards. This memory must be mapped into the memory space below 16MB.

Note: This field is for experienced users only.

Options **15M-16M**
 Disabled (*)

5.5.6 P2C/C2P Concurrency

When disabled, P2C/C2P will be occupied during the entire P2C/C2P operation period.

Options **Enabled**
 Disabled (*)

5.5.7 CPU to PCI Write Buffer

When this field is enabled, CPU data is written to a write buffer prior to being sent to the PCI bus, in order to compensate for the speed differences between the CPU and the PCI bus. When disabled, the CPU data is sent directly to the PCI bus, however, because the CPU operates at a faster speed than the PCI bus, the CPU must wait as the PCI bus receives data before beginning each write cycle.

Options **Enabled(*)**
 Disabled

5.5.8 PCI Dynamic Bursting

When enabled, every write transaction goes to the write buffer, and burstable transactions will then burst on the PCI bus, and non-burstable transactions won't burst on the PCI bus.

When disabled, if the write transaction is a burst transaction, the information goes into the write buffer and burst transfers are later performed on the PCI bus. If the transaction is not a burst transaction, PCI write occurs immediately (after a write buffer flush).

Options **Enabled(*)**
 Disabled

5.5.9 Delay Transaction

The chipset has embedded 32-bit posted writer buffer to support delayed transaction cycles. When enable, the system is compliant with PCI specification version 2.1

Options **Enabled(*)**
 Disabled

5.5.10 System BIOS cacheable

When enable accesses to the system BIOS will be cached

Option **Enable(*)**
 Disable

5.5.11 Video RAM Cacheable

When enabled, access to the video memory located at A0000H to BFFFFH will be cached.

Options **Enabled(*)**
 Disabled

5.5.12 AGP Aperture Size (MB)

This field specifies the size of system memory that can be used for AGP graphics aperture.

Options **4M / 8M / 16M / 32M / 64M (*) / 128M**

5.5.13 AGP-4X Mode

This item allows you to enable / disable the AGP-4X (Clock 266MHz) Mode.

Options **Enabled(*)**
 Disabled

5.5.14 AGP Fast Write

This item will enable/disable the AGP model.

Option **Enabled**
 Disabled(*)

5.5.15 OnChip USB Port 0

This should be enabled if your system have USB port 0 external on the system board and you wish to use it. Even when so equipped, if you add a higher performance controller, you will need to disable this feature.

Options **Enabled**
 Disabled (*)

5.5.16 OnChip USB Port1

This should be enabled if your system have USB port 1 internal on the system board and you wish to use it. Even when so equipped, if you add a higher performance controller, you will need to disable this feature.

Options **Enabled**
 Disabled (*)

5.5.17 USB Keyboard Under DOS

Select Enabled if your system contains a Universal Serial Bus (USB) controller and you have a USB keyboard under DOS

Options **Enabled**
 Disabled (*)

5.6 Integrated Peripherals



5.6.1 On-Chip IDE Channel 10

This field enables or disables the onboard IDE controller.

Options **Enabled(*)**
 Disabled

5.6.2 On-Chip IDE Channel 11

This field enables or disables the onboard IDE controller.

Options **Enabled(*)**
 Disabled

5.6.3 Primary Master/Slave PIO

These fields configure the PIO (Programmable Input Output) transfer mode for IDE controller. The maximum transfer rates of each PIO mode are listing as follo

Options	Description
Auto (*)	The BIOS negotiates with device automatically
Mode0	Use Mode 0 timing to access device
Mode1	Use Mode 1 timing to access device
Mode2	Use Mode 2 timing to access device
Mode3	Use Mode 3 timing to access device
Mode4	Use Mode 4 timing to access device

5.6.4 Secondary Master/Slave PIO

These fields configure the PIO (Programmable Input Output) transfer mode for IDE controller. The maximum transfer rates of each PIO mode are listing as follow:

Options	Description
Auto (*)	The BIOS negotiates with device automatically
Mode0	Use Mode 0 timing to access device
Mode1	Use Mode 1 timing to access device
Mode2	Use Mode 2 timing to access device
Mode3	Use Mode 3 timing to access device
Mode4	Use Mode 4 timing to access device

5.6.5 Secondary Master / Slave UDMA

If you select Auto, the IDE controller uses Ultra DMA 33/66 Mode to access Ultra DMA-capable IDE devices.

Options	Auto (*)
	Disabled

5.6.6 Init Display First

This item allows you to decide which slot to activate first, either PCI slot or AGP slot. This function takes place during the system boot.

Options	PCI Slot
	AGP (*)

5.6.7 AC97 Audio

This item allows you to decide to enable/disable the VIA chipset family to support AC97 Audio.

Options	Auto
	press Enter

- 5.6.7.1 Onboard Sound blaster
This item allows you to decide onboard legacy sound blaster compatible device.
Options **Enabled(*)**
 Disabled
- 5.6.7.2 SB I/O Address Use
This item allows you to select sound blaster I/O address.
Options **220H(*)/240H/260H/280H**
- 5.6.7.3 SB IRQ Use Select
This item allows you to select sound blaster IRQ.
Options **IRQ5(*) / 7 / 9 / 10**
- 5.6.7.4 SB DMA Use Select
This item allows you to select sound blaster DMA channel.
Options **DMA 0 / 1(*) / 2 / 3**
- 5.6.7.5 MIDI Port
This item allows you to select MIDI Port enable/disable.
Options **Enabled**
 Disabled(*)
- 5.6.7.6 MIDI Address Port
This item allows you to select MIDI Port I/O address.
Options **330-303H / 310-313H / 320-323H / 330-333H(*)**
- 5.6.7.7 Game port Address
This item allows you to select game port enable/disable.
Option **Disable**
 200-207H(*)

5.6.8 AC97 Modem

This item allows you to decide to enable/disable the VIA chipset family to support AC97 Modem.

- Options **Auto(*)**
 Disable

5.6.9 IDE HDD Block Mode

When enabled, the IDE controller will use the faster block mode to access devices.

Options **Enabled(*)**
 Disabled

5.6.10 Onboard FDC Controller

This field enables or disables the onboard floppy controller. Select enabled if you intend to use your floppy disk drive.

Options **Enabled(*)**
 Disabled

5.6.11 Onboard Serial Port 1 / 2

These fields configure the onboard serial ports. There are several port addresses and IRQ channels to select from.

Options	Description
3F8 / IRQ 4(*)	Port address 3F8h, IRQ 4
2F8 / IRQ 3(*)	Port address 2F8h, IRQ 3
3E8 / IRQ 4	Port address 3E8h, IRQ 4
2E8 / IRQ 3	Port address 2E8h, IRQ 3
Auto	BIOS assigns port address and IRQ channel automatically
Disabled	Disables serial port

5.6.12 COM2 Mode Select

A second serial port is using a serial port bracket connected from the motherboard to an expansion slot opening.

Options **Standard(*),HPSIR,ASKIR**

5.6.12.1 RxD, TxD Active for HPSIR and ASKIR functions

When setting the field to either IrDA or ASKIR, you must select the active level of receiving and transmission signal.

Options **Hi, Lo (*) / Lo, Hi / Lo, Lo / Hi, Hi**

5.6.12.2 IR Duplex Mode

When setting the field to either HPSIR or ASKIR, you must select the mode of receiving and transmitting signals.

Options **Half (*) / Full**

5.8.13 Onboard Parallel Port

This field configures the single onboard parallel port (LPT). There are several port addresses and IRQ channels to select from.

Options	Description
378 / IRQ 7(*)	Port address 378h, IRQ 7
278 / IRQ 5	Port address 278h, IRQ 5
3BC / IRQ 7	Port address 3BCh, IRQ 7
Disabled	Disables parallel port

5.6.14 Parallel Port Mode

This field configures the operating mode of an onboard parallel port. Ensure you know the specifications of your parallel port devices before selecting field.

Options **SPP (*) / EPP / ECP / ECP+EPP**

5.6.14.1 ECP Mode Use DMA

When the Parallel Port Mode field is configured as ECP, it needs a DMA channel for data transfer. This field specifies the DMA channel for ECP parallel port use.

DMA Options	Description
1	Use DMA channel 1
3 (*)	Use DMA channel 3

5.6.14.2 EPP Mode Select

When the Parallel Port Mode field is configured as EPP, mode, the EPP version needs to be specified. Please check the EPP specifications before selecting field.

EPP Options	Description
EPP1.7	Use EPP 1.7 protocol
EPP1.9 (*)	Use EPP 1.9 protocol

5.6.14.3 ECP+EPP Mode Select

When the Parallel Port Mode field is configured as ECP+EPP mode, both the DMA channel and the EPP version need to be specified. Please check the specifications before selecting field.

DMA Options	Description
1	Use DMA channel 1
3 (*)	Use DMA channel 3

EPP Options	Description
EPP1.7	Use EPP 1.7 protocol
EPP1.9 (*)	Use EPP 1.9 protocol

5.7 Power Management Setup

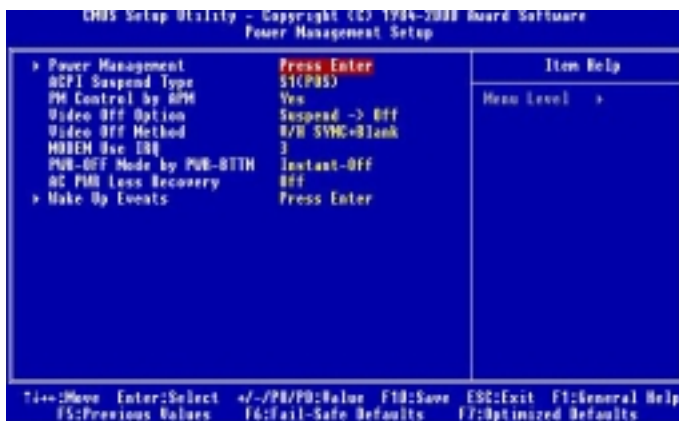

Each power-saving mode has a respective timer. The value of the timer can be assigned or reloaded and it will count down to zero. When the timer equals to zero, the system will be forced into the related suspend or power-saving mode. If any predefined signal or event is detected during the timer counting period, the timer restarts automatically.

5.7.1 Power Management

This feature allows the user to select the default parameters for the power-saving mode.

Options	Description
Min saving	When idle for one hour, the system enters suspend mode
Max Saving	When idle for fifteen minutes, the system enters suspend mode
User Define (*)	User can specify the time the system enters suspend mode

5.7.1.1 APM HDD Power Down Timer

This field specifies the time the system enters HDD power down. It is available only when the Power Management field is set to User Define.

Options **1 Min / 2 Min / 3 Min / 4 Min / 5 Min / 6 Min / 7 Min / 8 Min / 9 Min / 10 Min / 11Min / 12 Min / 13Min / 14Min / 15Min/ Disable(*)**

5.7.1.2 APM Doze Timer Mode

This field specifies the timer value of Doze Mode. It is available only when the Power Management field set to User Define.

Options **1 Min / 2 Min / 4 Min / 6 Min / 8 Min / 10 Min / 20 Min 30 Min / 1 Hour / Disable(*)**

5.7.1.3 APM Suspend Timer

This field specifies the time the system enters power-saving mode. It is available only when the Power Management field is set to User Define.

Options **1 Min / 2 Min / 4 Min / 6 Min / 8 Min / 10 Min / 20 Min / 30 Min / 40 Min / 1 Hour / Disable (*)**

5.7.2 ACPI Suspend Type

There are several ACPI modes used to save computer's energy

S1 (POS)(*) This is the Power-On-State, the CPU clock runs at slower speed, the system operates at slower speed

S3 (STR) This is the Suspend-To-Ram State, all system data will be saved in system's memory and all devices except the memory will shut off



Please checking your VGA card, can support the S3 mode .

5.7.3 PM Control by APM

When enabled, an Advanced Power Management (APM) protocol will be activated to handle the power-saving mode.

Options **Yes (*)**
No

5.7.4 Video off Option

This field specifies the method that video subsystem used for power saving.

Options	Description
Always ON	Monitor will remain on during power saving modes
Suspend Off	Monitor blanked when the systems enters the Suspend modes
All Modes Off	Monitor blanked when the system enters any power saving mode.

5.7.5 Video off Method

This field specifies the method that video subsystem used for power saving.

Options	Description
V/H SYNC+Blank	Turn off the vertical and horizontal synchronization ports and write blanks to the video buffer
Blank Screen	Writes blanks to the video buffer only
DPMS (*)	Initial display power management signaling with DPMS

5.7.6 MODEM Use IRQ

This determines the IRQ in which the Modem can use.

options 3(*)/4/5/7/9/10/11/NA

5.7.7 PWR-OFF Mode by PWR-BTTN

This field specifies the function of power button.

Options	Description
Instant-Off(*)	When power button is pressed, the system turns off immediately.
Delay 4 Sec.	After the power button has been pressed and held for four seconds, the system turns off.

5.7.8 AC PWR Loss Recovery

The field configures the system status after experiencing a power failure.

Options	Description
Former-Sts	System returns to former status prior to power failure (on or off)
Off(*)	System remains off after power lost

5.7.9 Wake Up Events

These are I/O events whose occurrence can prevent the system from entering a power-saving mode, or can awaken the system from such a mode. In effect, the system remains alert for anything that occurs to a device configured and recognized by the system, even when the system is in a power down mode.

- 5.7.9.1 VGA

When ON, your can set the VGA to awaken the system.

Options **OFF(*)**
 ON

- 5.7.9.2 LPT & COM

When On, any activity from one of the listed system peripheral devices or IRQs wakes up the system.

Options **None**
 LPT
 COM
 LPT/COM(*)

- 5.7.9.3 HDD & FDD

When On, any activity from either hard disk drive or floppy disk drive wakes up the system.

Options **OFF**
 ON(*)

- 5.7.9.4 PCI master
 When On, the system can be resumed from power saving mode by any PCI / master activity signal.
- Options **OFF (*)**
 ON
- 5.7.9.5 Wake up by PCI card
 When enabled, you can “wake-up” your system using a PCI rev.2.2 card, such as a WOL card, connected in your PCI slot.
- Options **Enabled**
 Disabled (*)
- 5.7.9.6 Wake Up by Ring/LAN
 When enabled, the PC can power-on through an external modem connected to your PC. For example, you may send an e-mail message to your PC from another location, and this will power-on your PC. When using this feature, you must have a modem, and your PC must be turned off.
Note: This feature alone doesn’t allow you to power off your PC (see 4.6.9 Suspend Mode).
- Options **Enabled**
 Disabled (*)
- 5.7.9.7 PWROn/Resume by Alarm
 When enabled, you can set the date and time to automatically power-on your PC (similar to an alarm clock). The alarm from RTC (real-time clock) automatically turns on the system.
- Options Description
Disabled (*) Disables RTC alarm function
Enabled Sets Date (0-31) and Timer (hr, min, sec) to power-on the PC. When date is set to 0, the Timer is set for every day.
- 5.7.9.8 IRQs Activity Monitoring
 When On, any event that occurs will awaken the system after it has powered-down. The following is a list of IRQ’s, or “Interrupt Requests,” which can be exempted much as the COM ports and LPT ports above can. When an I/O device wants to gain the attention of the operating system, it signals this by causing an IRQ to occur. When the operating system is ready to respond to the request, it interrupts itself and performs the service.

IRQ	Options
IRQ3 (COM2)	Disable/Enable(*)
IRQ4 (COM1)	Disable/Enable(*)
IRQ5 (LPT 2)	Disable/Enable(*)
IRQ6 (Floppy Disk)	Disable/Enable(*)
IRQ7 (LPT 1)	Disable/Enable(*)
IRQ8 (RTC Alarm)	Disable(*)/Enable
IRQ9 (IRQ2 Redir)	Disable(*)/Enable
IRQ10 (Reserved)	Disable(*)/Enable
IRQ11 (Reserved)	Disable(*)/Enable
IRQ12 (PS / 2 Mouse)	Disable/Enable(*)
IRQ13 (Coprocessor)	Disable/Enable(*)
IRQ14 (Hard Disk)	Disable/Enable
IRQ15 (Reserved)	Disable(*)/Enable

5.8 PnP/PCI Configurations

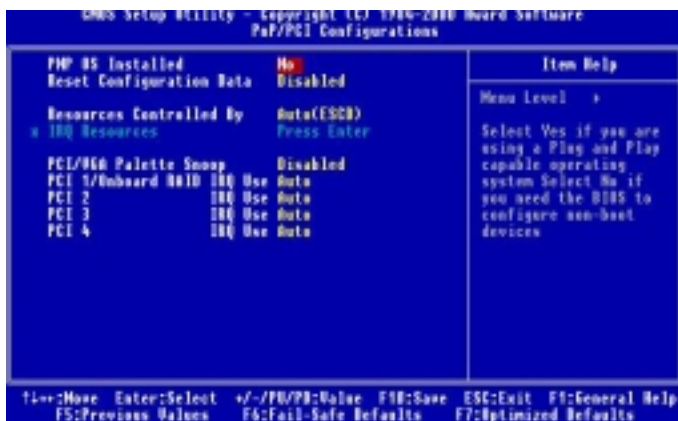

5.8.1 PNP OS Installed

The field specifies whether a Plug and Play operating system is installed.

- Options **Yes**
 No (*)

5.8.2 Reset Configuration Data

Normally, you leave this field Disabled. Select Enabled to reset Extended System Configuration Data (ESCD) when you exit Setup if you have installed a new add-on and the system reconfiguration has caused such a serious conflict that the operating system can not boot.

- Options **Enabled**
 Disabled (*)

5.8.3 Resources Controlled By

The Award Plug and Play BIOS has the capacity to automatically configure all of the boot and Plug and Play compatible devices. However, this capability means absolutely nothing unless you are using a Plug and Play operating system such as Windows 98/95/NT. If you set this field to “manual” choose specific resources by going into each of the sub menu that follows this field (a sub menu is preceded by a “Ø”).

Options	Description
Auto(ESCD)(*)	Resources controlled by BIOS automatically
Manual	Resources controlled by the user

5.8.3.1 IRQ Resources

When resources are controlled manually, assign each system interrupt a type, depending on the type of device using the interrupt.

5.8.3.1.1 IRQ3/4/5/7/9/10/11/12/14/15 assigned to

This item allows you to determine the IRQ assigned to the ISA bus and is not available to any PCI slot. Legacy ISA for devices compliant with the original PC AT bus specification, PCI/ISA PnP for devices compliant with the Plug and Play standard whether designed for PCI or ISA bus architecture.

Options	PCIDevice
	Reserved

5.8.4 PCI / VGA Palette Snoop

This field controls the ability of a primary PCI graphics controller to share a common palette with an ISA/VESA video or MPEG card

Options	Description
Enabled	PCI VGA co-works with ISA MPEG card
Disabled (*)	All cases except above

5.8.5 PCI 1/ On board RAID IRQ Use (On board RAID VD133 Pro only)

This field determines the IRQ setting for PCI1. PCI1 and PC2 may share the same IRQ, or other options may be selected. The default setting for this field is Auto, which uses automatic-routing to determine the setting.

Options **Auto (*) / 3 / 4 / 5 / 7 / 9 / 10 / 11 / 12 / 14 / 15**

5.8.6 PCI 2 IRQ Use

This field determines the IRQ setting for PCI2. The default setting for this field is Auto, which uses automatic-routing to determine the setting.

Options **Auto (*) / 3 / 4 / 5 / 7 / 9 / 10 / 11 / 12 / 14 / 15**

5.8.7 PCI 3 IRQ Use

This field determines the IRQ setting for PCI3. The default setting for this field is Auto, which uses automatic-routing to determine the setting.

Options **Auto** (*) / 3 / 4 / 5 / 7 / 9 / 10 / 11 / 12 / 14 / 15

5.8.8 PCI 4 IRQ Use

This field determines the IRQ setting for PCI4. The default setting for this field is Auto, which uses automatic-routing to determine the setting.

Options **Auto** (*) / 3 / 4 / 5 / 7 / 9 / 10 / 11 / 12 / 14 / 15

5.9 PC Health Status

This page is monitoring your status of computer. On the screen displays CPU/System temperature, FAN speed, and voltages.

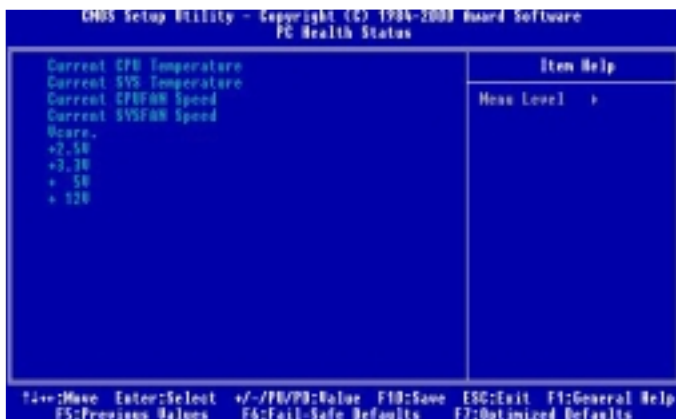

5.10 IWILL Smart Setting

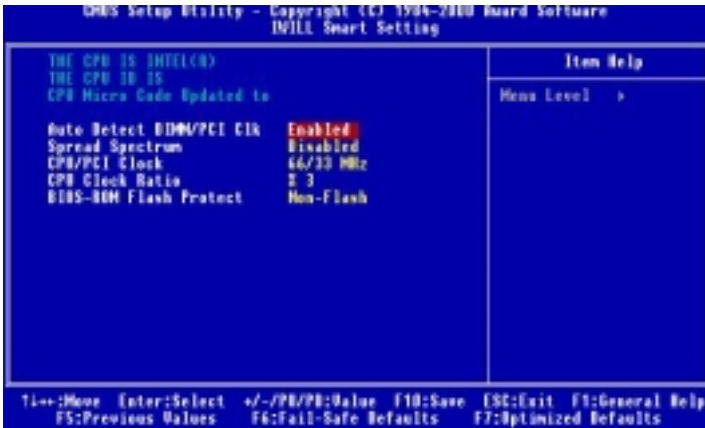

Over-clocking is not guaranteed. Users must have substantial knowledge of proper CPU relative to adjusting CPU speeds. Over-clocking should be done only by experienced engineers who conduct tests.

5.10.1 Auto Detect DIMM/PCI Clk

When enabled, the motherboard will automatically disable the clock source for a DIMM socket, which does not have a module on it. This is true for all PCI slots.

Options **Enabled(*)**
 Disabled

5.10.2 Spread Spectrum

This item configures radiation emitted from the system. When enabled, system will release less radiation.

Options **Enabled**
 Disabled (*)



Over-clocking sometimes makes computer not work properly. You would close the system and power and play "insert" the key on the keyboard. Waiting to see the monitor frame and set "insert" key.

5.10.3 CPU / PCI Clock

This field allows user to adjust the CPU external frequency.

Options **BYJUMPER**

66/33MHz, 68/34MHz, 75/37MHz, 80/40MHz, 83/41MHz, 90/30MHz,
95/31MHz, 100/133MHz, 103/34MHz, 105/35MHz, 110/36MHz,
112/37MHz, 115/38MHz, 124/31MHz, 130/32MHz, 133/33MHz,
135/34MHz, 138/34MHz, 140/35MHz, 144/36MHz, 150/37MHz,
155/38MHz, 160/40MHz, 166/41MHz

5.10.4 PU Clock Ratio:

Option **3/3.5/4/4.5/5/5.5/6/6.5/7/7.5/8**

5.11 Load Fail-Safe Defaults

When you press <Enter> on this item you get a confirmation dialog box with a message similar to:

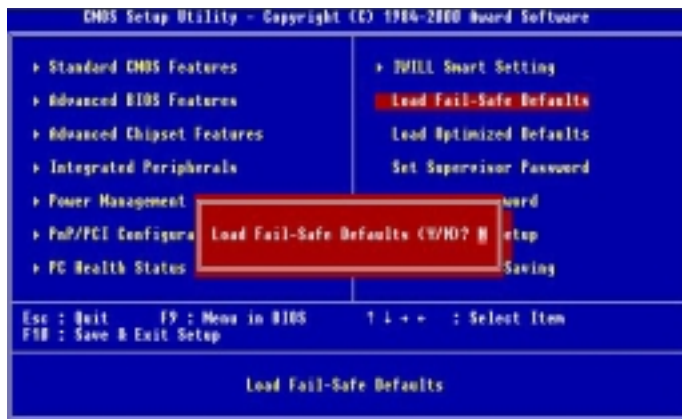

Pressing ‘Y’ loads the BIOS default values for the most stable, minimal-performance system operations.

on this item you get a confirmation dialog box with a message similar to:

5.12 Load Optimized Defaults

When you press <Enter> on this item you get a confirmation dialog box with a message similar to:



Pressing ‘Y’ loads the default values that are factory settings for optimal performance system operations.

5.13 Set Supervisor / User Password Setting

These setup pages are used for password setting. When a password has been enabled and the Security Option field is set as Setup, you will be required to enter the password every time you try to enter BIOS Setup program. This prevents an unauthorized person from changing any part of your system configuration. Additionally, if the Security Option field is set as Boot, the BIOS will request a password every time your system boot. This would prevent unauthorized use of your computer.

In you wish to use this function, bring the cursor to this field, then press <Enter>. The computer will display the message, “Enter Password”. Type your password and press <Enter>. After the message onfirm Password” is displayed, re-type your password. The Supervisor Password function will be in effect after you save and exit setup.

To disable a password, bring the cursor to this field, then press <Enter>. The computer will display the message, “Enter Password”. Press <Enter>. A message will confirm that the password is disabled. Once the password is disabled, the system will boot and you can enter setup program freely.



The User Password allows you to enter BIOS setup program, but you cannot change the value of any fields. Please keep your password in safe place.

5.14 Save & Exit Setup

Saves current CMOS value and exit BIOS setup program.

5.15 Exit Without Saving

Abandons all CMOS value changes and exits BIOS setup program.

Chapter 6

Power Installer CD

6.1 Software Installation

The attached Power Installer CD contains all the necessary drivers, utilities for IWILL's full range of motherboards. It provides an easy way for users to install the needed drivers without going through a complicated process. The Power Installer CD is able to auto-detect and display the drivers, utilities needed for your motherboard.

6.1.1 What's inside Power Installer CD for this motherboard

1. Drivers

Service Pack Driver

Software Audio Driver

Iwill SIDE RAID 66 Install Guide (VD133 Pro only)

2. Utilities

Make Driver Diskettes

Anti-Virus

Hardware Monitor Utility(Window9X only)

STD guide

Acrobat Reader

High Point Xstore Pro(Window9X only)(VD133 Pro only)

Iwill SIDE RAID 66 Install Utility (VD133 Pro only)

3. Manuals

6.2 How to use the Power installer CD

The Power Installer CD supports the Auto Run program under Windows 98/95 and Windows NT operating systems. All the necessary drivers, utilities and manual for this motherboard will show on the screen. Select the one that needs to be installed, then simply follow the messages displayed on the screen to complete setup.



IWILL Power Installer does not support a keyboard at this moment. You must use a mouse to install it.

6.2.1 How to view manual

This Power Installer CD includes detailed information of all IWILL manuals for every motherboard manufactured by IWILL. Please insert the IWILL Power Installer CD into the CD-ROM drive; Click the “View Manual” item, and select the product that you want to view.

6.2.2 How to make driver diskette

6.2.2.1 Without O.S. installed

This bootable Power Installer CD also allows you to boot up your system, even when the OS has not been installed. During the boot-up process, you can perform “IWILL Diskette Creator,” which will automatically make the driver diskettes you need.



At least one CD-ROM drive and one 1.44M floppy drive are necessary to make ""IWILL Diskette Creator"" work properly.

Follow the instructions below to make your own device driver floppy diskettes if you have a CD-ROM with IDE interface. If you have already installed SCSI CD-ROM, please make sure your SCSI host adapter supports bootable CD-ROM, and then proceed directly to step 8 , and then finish the procedure.

1. First, power-on or “boot” your system.
2. Press key during boot sequence to enter “**CMOS Setup Utility**”
3. Use arrow keys to select “**ADVANCED BIOS FEATURES**” on the menu, then press “**Enter**.”
4. Select “**First Boot Device**” and change the default setting from “**Floppy**” to “**CDROM**” using Page Up /Page Down key.
5. Press <Esc> key to go back to CMOS SETUP Utility menu.
6. Press <F10> to select “Save and Exit Setup”
7. Press “**Y**” then “**Enter**” to complete. Now you are able to boot up the system from the CD-ROM.
8. Insert the Power Installer CD into the CD-ROM drive and re-start the computer.
9. IWILL Diskette Creator will now execute automatically for making your own driver diskettes.
10. Make the desired driver diskettes according to the instructions displayed on screen.

6.2.2.2 Under windows 98/95/NT

You may just click on the software **Make Driver Diskettes Utility** shown on screen, then select the driver you need, follow the messages shown on screen to complete.

6.2.4 How to install VIA Service Pack(4 in 1. EX: Bus Master, ACPI, IRQ, AGP)

Simply click on the software shown on screen that needs to be installed, then simply follow the messages displayed on the screen to complete setup.

Simply click on the software shown on screen that needs to be installed, then simply follow the messages displayed on the screen to complete setup.

6.2.4 How to install Security Driver

You may just click on the **Security Driver** shown on screen that needs to be installed, then follow the prompts to complete setup.

6.2.5 How to install Software Audio Driver

You may just click on the **Software Audio Driver** shown on screen that needs to be installed, then follow the prompts to complete setup.

6.2.6 How to install Iwill SIDE RAID 66 Utility (VD133 Pro only)

You may just click on the **Iwill SIDE RAID 66 Installation Utility** shown on screen . Please follow the instructions to install the network driver.

6.2.7 How to use PC-Cillin Anti-Virus program

Simply click on the **PC-Cillin Anti-Virus** shown on screen that be installed, then follow the prompts to complete setup.

6.2.8 How to use Hardware Monitoring Utility(Window 9X only)

You may just click on the **Hardware Monitor Utility** shown on screen then follow the prompts to complete setup.

6.2.9 How to install Highpoint Xstore Pro(Window 9X only) (VD133 Pro only)

You may just click on the **Highpoint Xstore Pro** shown on screen then follow the prompts to complete setup.

6.3 Installing Operating Systems

This section briefly demonstrates how to install a few popular software operating systems. Use this section only as a guide. It is highly recommended that users first refer to the installation manual of their operating system for a more thorough, detailed description on how to install the operating system.

6.3.1 Windows 98

Whenever installing Windows 98, please remember that Setup creates a new folder for Windows 98, and won't transfer any existing system settings. Windows 98 will become your default operating system, and will use standard system settings. This procedure represents an entirely new installation of Windows, therefore you'll need to reinstall any existing programs you may want to use.

There are two ways to install Windows 98. Each method depends on your current computer setup.



During Setup, your computer will automatically restart several times using the Windows 98 Setup wizard.

- 6.3.1.1 Installing the CD-ROM version of Windows 98
1. Place a Windows 98 Startup Disk into the floppy disk drive.
 2. Restart your computer.
The Microsoft Windows 98 Startup menu will appear.
 3. Place the Windows 98 CD into your CD-ROM drive.
 4. Type the number 1 and press <ENTER>.
A series of scans is performed, and then the MS-DOS prompt is displayed.
 5. Type the word setup at the MS-DOS display, and press <ENTER>.
Setup performs a check (A message will be displayed).
This message won't appear if your computer can't locate your CD-ROM drive. If you haven't installed the correct CD-ROM driver, please consult your drive's documentation or contact your hardware manufacturer.
 6. Press <ENTER>.
Microsoft ScanDisk will check your disk drives for errors.
 7. When ScanDisk finishes, press the X key.
Setup will initialize. Then, Windows 98 Setup begins.
 8. Please follow the instructions that are displayed.



Setup may ask you to insert your original Windows 95 or Windows 3.1 disks if you're using the upgrade version of Windows 98.

6.3.2 Windows NT

- 6.3.2.1 Installing the CD-ROM version of Windows NT on an IDE system
1. First, power-on or "boot" your system.
 2. Press key during boot sequence to enter " CMOS Setup Utility"
 3. Use arrow keys to select "BIOS FEATURES SETUP" on the menu, then press "Enter."
 4. Select "Boot Sequence" and change the default setting from A, C, SCSI to "CD-ROM, C, A" using Page Up/Page Down key.
 5. Place the Windows NT 4.0 CD-ROM in the drive.
 6. Follow all instructions to finish Windows NT installation.