

ASUS[®] P2L-N/P2E-N
Pentium[®] II NLX Motherboards

USER'S MANUAL

USER'S NOTICE

No part of this manual, including the products and software described in it, may be reproduced, transmitted, transcribed, stored in a retrieval system, or translated into any language in any form or by any means, except documentation kept by the purchaser for backup purposes, without the express written permission of ASUSTeK COMPUTER INC. ("ASUS").

ASUS PROVIDES THIS MANUAL "AS IS" WITHOUT WARRANTY OF ANY KIND, EITHER EXPRESS OR IMPLIED, INCLUDING BUT NOT LIMITED TO THE IMPLIED WARRANTIES OR CONDITIONS OF MERCHANTABILITY OR FITNESS FOR A PARTICULAR PURPOSE. IN NO EVENT SHALL ASUS, ITS DIRECTORS, OFFICERS, EMPLOYEES OR AGENTS BE LIABLE FOR ANY INDIRECT, SPECIAL, INCIDENTAL, OR CONSEQUENTIAL DAMAGES (INCLUDING DAMAGES FOR LOSS OF PROFITS, LOSS OF BUSINESS, LOSS OF USE OR DATA, INTERRUPTION OF BUSINESS AND THE LIKE), EVEN IF ASUS HAS BEEN ADVISED OF THE POSSIBILITY OF SUCH DAMAGES ARISING FROM ANY DEFECT OR ERROR IN THIS MANUAL OR PRODUCT.

Product warranty or service will not be extended if: (1) the product is repaired, modified or altered, unless such repair, modification or alteration is authorized in writing by ASUS; or (2) the serial number of the product is defaced or missing.

Products and corporate names appearing in this manual may or may not be registered trademarks or copyrights of their respective companies, and are used only for identification or explanation and to the owners' benefit, without intent to infringe.

- Intel, LANDesk, and Pentium are registered trademarks of Intel Corporation.
- IBM and OS/2 are registered trademarks of International Business Machines.
- Symbios is a registered trademark of Symbios Logic Corporation.
- Windows and MS-DOS are registered trademarks of Microsoft Corporation.
- Sound Blaster AWE32 and SB16 are trademarks of Creative Technology Ltd.
- Adobe and Acrobat are registered trademarks of Adobe Systems Incorporated.

The product name and revision number are both printed on the product itself. Manual revisions are released for each product design represented by the digit before and after the period of the manual revision number. Manual updates are represented by the third digit in the manual revision number.

For previous or updated manuals, BIOS, drivers, or product release information, contact ASUS at <http://www.asus.com.tw> or through any of the means indicated on the following page.

SPECIFICATIONS AND INFORMATION CONTAINED IN THIS MANUAL ARE FURNISHED FOR INFORMATIONAL USE ONLY, AND ARE SUBJECT TO CHANGE AT ANY TIME WITHOUT NOTICE, AND SHOULD NOT BE CONSTRUED AS A COMMITMENT BY ASUS. ASUS ASSUMES NO RESPONSIBILITY OR LIABILITY FOR ANY ERRORS OR INACCURACIES THAT MAY APPEAR IN THIS MANUAL, INCLUDING THE PRODUCTS AND SOFTWARE DESCRIBED IN IT.

Copyright © 1998 ASUSTeK COMPUTER INC. All Rights Reserved.

Product Name:	ASUS P2L-N/P2E-N
Manual Revision:	1.02
Release Date:	May 1998

ASUS CONTACT INFORMATION

ASUSTeK COMPUTER INC.

Marketing

Address: 150 Li-Te Road, Peitou, Taipei, Taiwan 112
Telephone: +886-2-2894-3447
Fax: +886-2-2894-3449
Email: info@asus.com.tw

Technical Support

Fax: +886-2-2895-9254
BBS: +886-2-2896-4667
Email: tsd@asus.com.tw
WWW: www.asus.com.tw
FTP: ftp.asus.com.tw/pub/ASUS

ASUS COMPUTER INTERNATIONAL

Marketing

Address: 6737 Mowry Ave, Mowry Business Center, Building 2,
Newark, CA 94560, USA
Fax: +1-510-608-4555
Email: info-usa@asus.com.tw

Technical Support

Fax: +1-510-608-4555
BBS: +1-510-739-3774
Email: tsd-usa@asus.com.tw
WWW: www.asus.com
FTP: ftp.asus.com.tw/pub/ASUS

ASUS COMPUTER GmbH

Marketing

Address: Harkort Str. 25, 40880 Ratingen, BRD, Germany
Telephone: 49-2102-445011
Fax: 49-2102-442066
Email: info-ger@asus.com.tw

Technical Support

Hotline: 49-2102-499712
BBS: 49-2102-448690
Email: tsd-ger@asus.com.tw
WWW: www.asuscom.de
FTP: ftp.asuscom.de/pub/ASUSCOM

CONTENTS

I. INTRODUCTION	7
How this manual is organized	7
Item Checklist	7
II. FEATURES	8
Features of the ASUS P2L-N/P2E-N Motherboard	8
Parts of the ASUS P2L-N/P2E-N Motherboard	11
Riser Card Back	11
Riser Card Front	11
III. INSTALLATION	12
ASUS P2L-N/P2E-N Motherboard Layout	12
Installation Steps	14
1. Jumpers	14
2. System Memory (DIMM)	15
DIMM Memory Installation	16
3. Central Processing Unit (CPU)	17
Pentium II Processor	17
AAVID Heatsink	21
Elan Vital Heatsink	21
4. Expansion Cards	22
Expansion Card Installation Procedure	22
Assigning IRQs for Expansion Cards	22
Assigning DMA Channels for ISA Cards	23
ISA Cards and Hardware Monitor	23
5. External Connectors	24
Front Panel Descriptions	29
Power Connection Procedures	33
IV. BIOS SOFTWARE	34
Support Software	34
Flash Memory Writer Utility	34
Main Menu	34
Managing and Updating Your Motherboard's BIOS	36
6. BIOS Setup	37
Load Defaults	38
Standard CMOS Setup	38
Details of Standard CMOS Setup:	38
BIOS Features Setup	41
Details of BIOS Features Setup	41
Chipset Features Setup	44
Details of Chipset Features Setup	44

CONTENTS

Power Management Setup	47
Details of Power Management Setup	47
PNP and PCI Setup	50
Details of PNP and PCI Setup	50
Load BIOS Defaults	52
Load Setup Defaults	52
Supervisor Password and User Password	53
IDE HDD Auto Detection	54
Save & Exit Setup	55
Exit Without Saving	55
V. Support CD	56
Support CD Main Menu	56
A. PC Probe Utility	57
B. Video Driver (Windows 95)	63
B. Other Video Drivers	83
C. Video Player	97
D. Audio Driver	103
E. Audio Software	109
F. ASUS LAN Card (Optional)	119

FCC & DOC COMPLIANCE

Federal Communications Commission Statement

This device complies with FCC Rules Part 15. Operation is subject to the following two conditions:

- This device may not cause harmful interference, and
- This device must accept any interference received, including interference that may cause undesired operation.

This equipment has been tested and found to comply with the limits for a Class B digital device, pursuant to Part 15 of the FCC Rules. These limits are designed to provide reasonable protection against harmful interference in a residential installation. This equipment generates, uses and can radiate radio frequency energy and, if not installed and used in accordance with manufacturer's instructions, may cause harmful interference to radio communications. However, there is no guarantee that interference will not occur in a particular installation. If this equipment does cause harmful interference to radio or television reception, which can be determined by turning the equipment off and on, the user is encouraged to try to correct the interference by one or more of the following measures:

- Reorient or relocate the receiving antenna.
- Increase the separation between the equipment and receiver.
- Connect the equipment to an outlet on a circuit different from that to which the receiver is connected.
- Consult the dealer or an experienced radio/TV technician for help.

WARNING! The use of shielded cables for connection of the monitor to the graphics card is required to assure compliance with FCC regulations. Changes or modifications to this unit not expressly approved by the party responsible for compliance could void the user's authority to operate this equipment.

Canadian Department of Communications Statement

This digital apparatus does not exceed the Class B limits for radio noise emissions from digital apparatus set out in the Radio Interference Regulations of the Canadian Department of Communications.

I. INTRODUCTION

How this manual is organized

This manual is divided into the following sections:

- I. Introduction:** Manual information and checklist
- II. Features:** Information and specifications concerning this product
- III. Installation:** Instructions on setting up the motherboard
- IV. BIOS Software:** Instructions on setting up the BIOS software
- V. Support CD:** Information on the included support software

Item Checklist

Please check that your package is complete. If you discover damaged or missing items, please contact your retailer.

- (1) ASUS motherboard
- (1) Retention mechanism & heatsink support
- (2) Attach mount bridges (preinstalled)
- (1) IDE ribbon cable for one hard disk drive
- (1) Floppy ribbon cable for one 3.5inch floppy disk drive
- (1) Support drivers and utilities
- (1) Motherboard User's Manual
- (1) System housing User's Manual

- (1) NLX Form-factor system housing, riser card, and power supply
- DIMM memory module
- 3.5inch Floppy Drive
- Slim CD-ROM and cable
- ASUS PCI-L101 Wake-on-LAN 10/100 Ethernet Card (optional)

II. FEATURES

Features of the ASUS P2L-N/P2E-N Motherboard

The ASUS P2L-N/P2E-N motherboard is carefully designed for the demanding PC user who wants many features in a small package.

ASUS P2L-N/P2E-N Specifications:

- **NLX:** Features ASUS' custom designed NLX form factor.
- **Multi-Speed:** Supports the Intel Pentium® II (233MHz–333MHz) and Celeron™ (266MHz and faster) processors.
- **Intel AGPset:** Features Intel's 440LX or 440EX AGPset with I/O subsystems.
- **Onboard AGP VGA:** Has ATI 3D Rage Pro AGP 2X VGA chipset onboard with several memory options from 2MB to 8MB.
- **Onboard Audio:** Has ESS 16-bit audio onboard.
- **Versatile Memory:** Is equipped with two DIMM sockets to support 8MB-128MB 168-pin 3.3Volt SDRAM/EDO memory modules up to 256MB.
- **Riser Card:** Provides NLX power, primary IDE, floppy drive, LAN wake up connector, 2 PCI slots, 1 ISA slot, 2 USB ports, and IrDA.
- **TV Out:** Supports optional onboard TV out function using ImpactTV2 chipset.
- **Ultra DMA/33 BM IDE:** Comes with an onboard PCI Bus Master IDE controller with two connectors that supports four IDE devices in two channels, supports Ultra DMA/33, PIO Modes 3 and 4 and Bus Master IDE DMA Mode 2, and supports Enhanced IDE devices, such as Tape Backup and CD-ROM drives. Supports two drives of either 5.25-inch (360KB or 1.2MB) or 3.5-inch (720KB, 1.44MB, or 2.88MB) disk drives. Supports Japanese "Floppy 3 mode" (3.5-inch disk drive: 1.2MB) and LS-120 floppy disk drives (3.5-inch disk drive: 120 MB, 1.44MB, 720K). BIOS supports IDE CD-ROM or SCSI device boot-up.
- **Onboard IrDA:** Has an infrared port on the riser card for wireless interface.
- **Multi-Cache:** Supports a Pentium® II processor with either 512KB, 256KB, or 0KB Pipelined Burst Level 2 cache in the Single Edge Contact (SEC) cartridge.
- **Slim CD-ROM:** Supports a notebook-sized slim CD-ROM drive.
- **Super Multi-I/O:** Provides two high-speed UART compatible serial ports and one parallel port with EPP and ECP capabilities. UART2 can also be directed from COM2 to the Infrared Module for wireless connections.

The P2L-N Motherboard adds:

- **Data Integrity:** Error Checking and Correction (ECC) through the 440LX chipset and ECC supported DIMM.

II. FEATURES

ASUS P2L-N/P2E-N Special Features:

- **ACPI Ready:** ACPI (Advanced Configuration and Power Interface) is also implemented on all ASUS smart series of motherboards. ACPI provides more Energy Saving Features for future operating systems (OS) supporting OS Direct Power Management (OSPM) functionality. With these features implemented in the OS, PCs can be ready around the clock, yet satisfy all the energy saving standards. To fully utilize the benefits of ACPI, an ACPI-supported OS such as the successor of Windows 95 must be used.
- **Desktop Management Interface (DMI):** Supports DMI through BIOS which allows hardware to communicate within a standard protocol creating a higher level of compatibility. (Requires DMI-enabled components.)
- **Easy Installation:** Incorporates BIOS that supports autodetection of hard disk drives, PS/2 mouse, and Plug and Play devices to make setup of hard disk drives, expansion cards, and other devices virtually automatic.
- **Enhanced ACPI & Anti-Boot Virus BIOS:** Programmable BIOS (Flash EEPROM), offering enhanced ACPI for Windows 98 compatibility, built-in hardware-based virus protection, and autodetection of most devices for virtually automatic setup.
- **PC '97 Compliant:** Both the BIOS and hardware levels of ASUS smart series of motherboards meet PC '97 compliancy. The new PC '97 requirements for systems and components are based on the following high-level goals: Support for Plug and Play compatibility and power management for configuring and managing all system components, and 32-bit device drivers and installation procedures for both Windows 95 or its successor and Windows NT.
- **Symbios SCSI BIOS:** Supports optional ASUS SCSI controller cards through onboard firmware.
- **Wake on LAN:** Supports Wake on LAN activity through optional ASUS PCI-L101 Fast Ethernet card.

ASUS P2L-N/P2E-N Performance

- **Concurrent PCI:** Concurrent PCI allows multiple PCI transfers from PCI master buses to memory to CPU.
- **Double the IDE Transfer Speed:** ASUS smart series of motherboards with Intel chipsets improves IDE transfer rate using Ultra DMA/33 Bus Master IDE, which can handle data transfer up to 33MB/s. The best of all is that this new technology is compatible with existing ATA-2 IDE specs so there is no need to upgrade current hard drives or cables.
- **SDRAM Optimized Performance:** ASUS smart series of motherboards support the new generation memory, Synchronous Dynamic Random Access Memory (SDRAM), which increases the data transfer rate from 264MB/s max using EDO memory to 528MB/s max using SDRAM.

II. FEATURES

ASUS P2L-N/P2E-N Intelligence

- **Auto Fan Off:** The system fans will power off automatically **even in sleep mode**. This function reduces both energy consumption *and* **system noise**, and is an important feature to implement silent PC systems.
- **Boot Virus Protection:** Anti-boot virus protection programmed into the BIOS.
- **Dual Function Power Button:** The system can be in one of two states, one is Sleep mode and the other is the Soft-Off mode. Pushing the power button for less than 4 seconds places the system into Sleep mode. When the power button is pressed for more than 4 seconds, it enters the Soft-Off mode.
- **Fan Status Monitoring and Alarm:** To prevent system overheating and system damage, the CPU fan and system fans can be monitored for RPM and failure. Each fan can be set for its normal RPM range and alarm thresholds.
- **Keyboard Power Up:** Keyboard Power Up can be enabled or disabled to allow the computer to be powered on by pressing the space bar on the keyboard.
- **Message LED (requires ACPI OS support):** Chassis LEDs now act as information providers. Through the way a particular LED illuminates, the user can determine the stage the computer is in. A simple glimpse provides useful information to the user.
- **Remote Ring On (requires external modem):** This allows a computer to be turned on remotely through an external modem. With this benefit on-hand, any user can access vital information from their computer from anywhere in the world!
- **System Resources Alert:** Today's operating systems such as Windows 95, Windows NT, and OS/2, require much more memory and hard drive space to present enormous user interfaces and run large applications. The system resource monitor will warn the user before the system resources are used up to prevent possible application crashes. Suggestions will give the user information on managing their limited resources more efficiently.
- **Temperature Monitoring and Alert:** To prevent system overheating and system damage, there are heat sensors to monitor the CPU (the Pentium II processor requires a special heatsink with a thermal sensor) and system temperatures to warn of damaging temperatures.
- **Voltage Monitoring and Alert:** System voltage levels are monitored to ensure stable current to critical motherboard components. Voltage specifications are more critical for future processors, so monitoring is necessary to ensure proper system configuration and management.

II. FEATURES

Parts of the ASUS P2L-N/P2E-N Motherboard

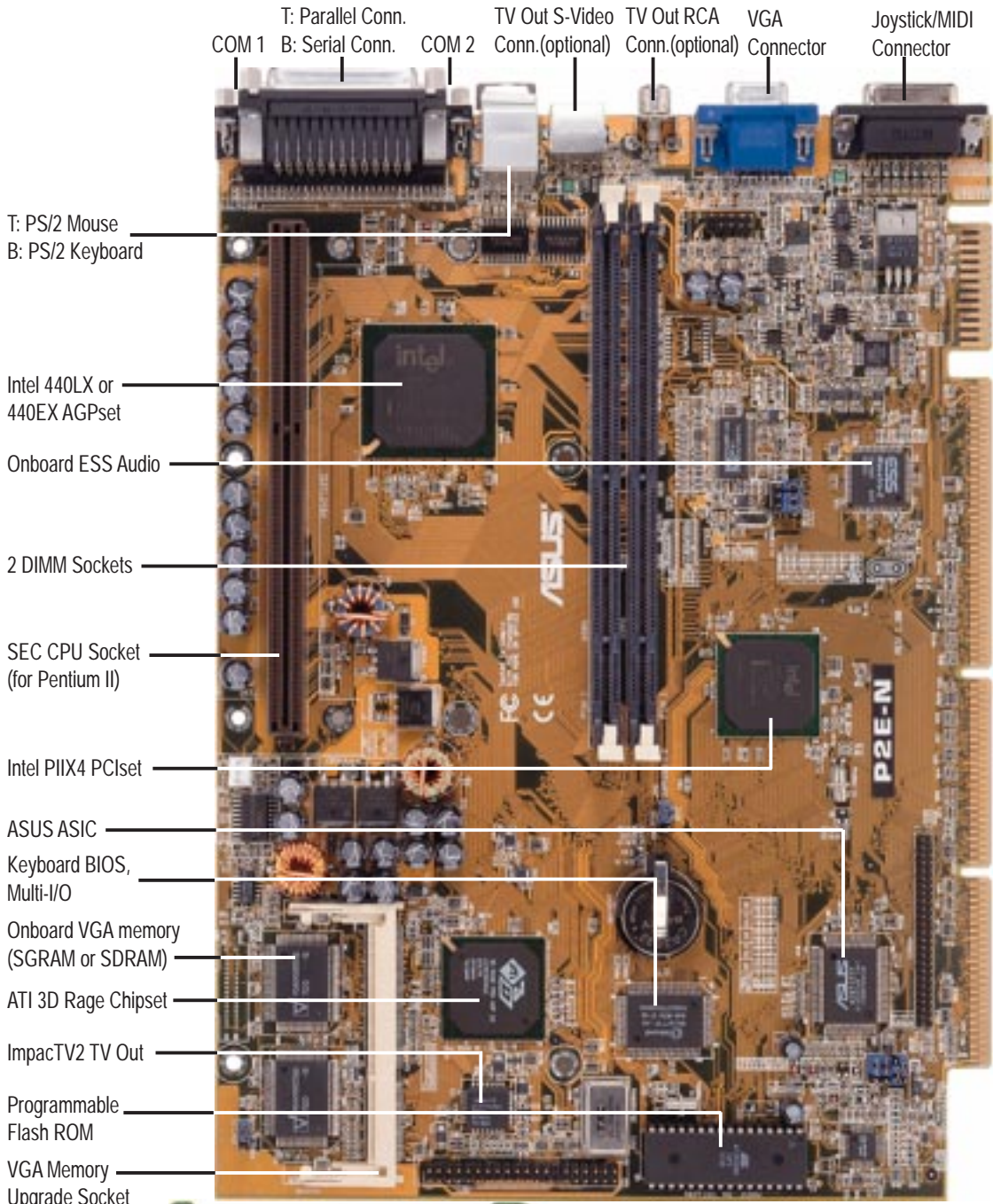

Riser Card Front



Riser Card Back

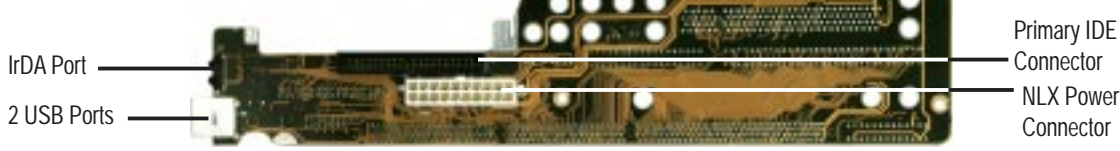

II. FEATURES
Motherboard Parts

III. INSTALLATION

ASUS P2L-N/P2E-N Motherboard Layout

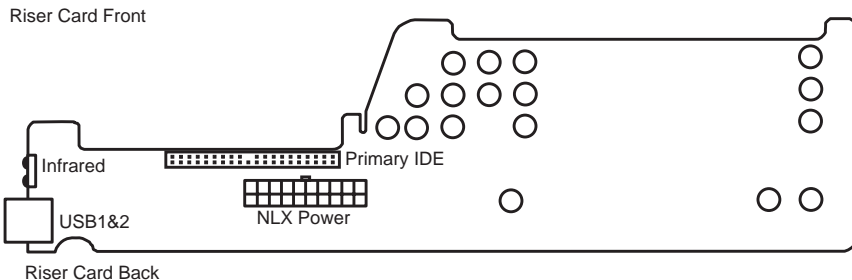
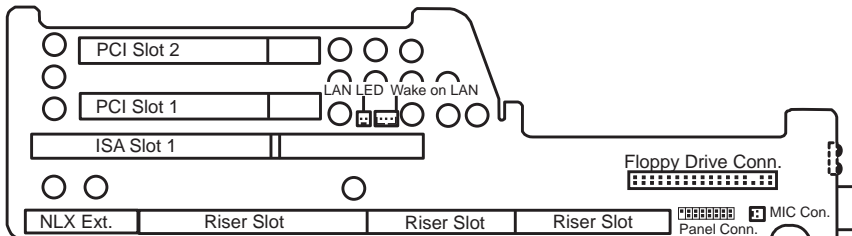
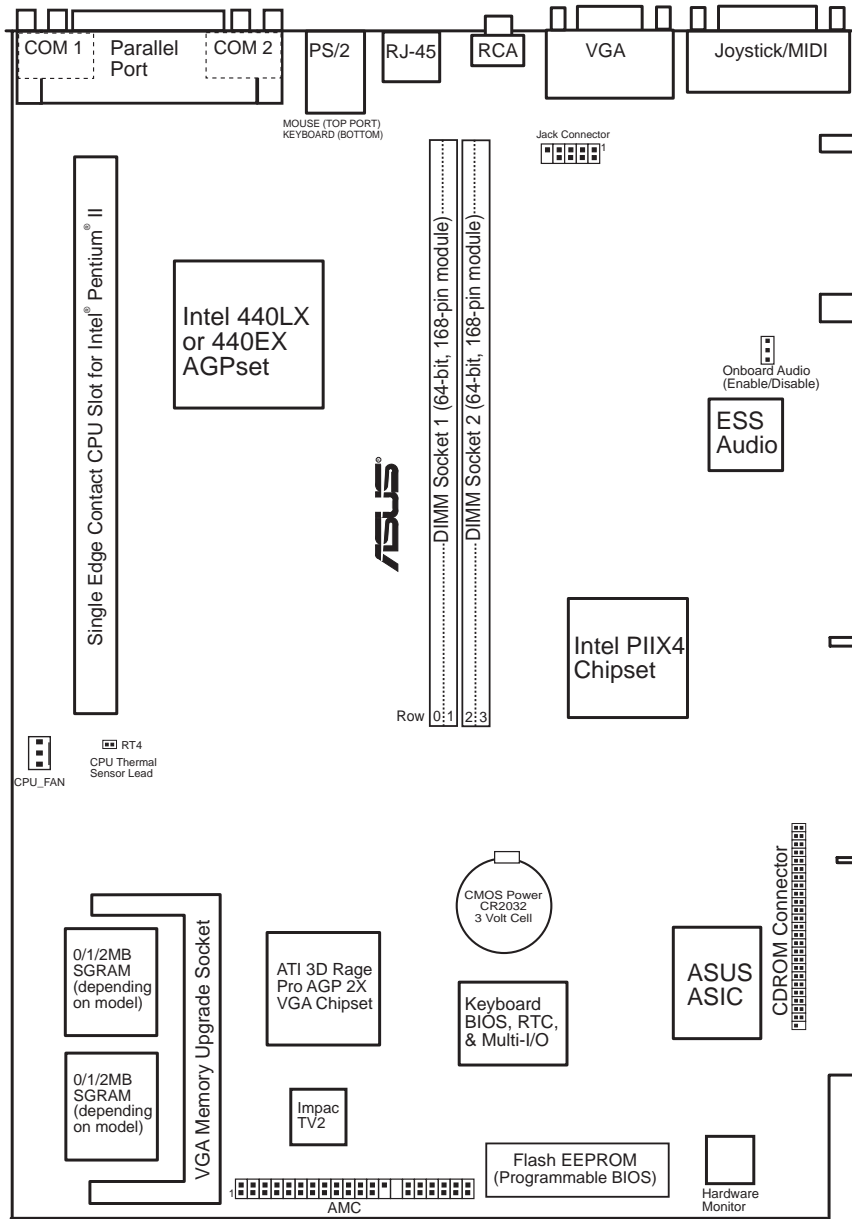

III. INSTALLATION
Motherboard Layout

III. INSTALLATION

Jumpers

- 1) JP1 p. 13 Audio Setting (Enable/Disable)

Expansion Slots

- 1) DIMM Sockets p. 15 168-Pin DIMM Memory Expansion Sockets
2) SEC CPU Slot p. 17 Single Edge Contact CPU Support
3) SLOT 1* p. 22 16-bit ISA Bus Expansion Slots*
4) PCI 1, 2 p. 22 32-bit PCI Bus Expansion Slots

Hardware Monitor

- 1) RT4 p. 20 Pentium II Processor Thermal Sensor Connector

Connectors

- 1) PS2KBMS p. 24 PS/2 Keyboard Connector (6-pin Female)
2) PS2MBMS p. 24 PS/2 Mouse Connector (6-pin Female)
3) GAME p. 24 Joystick or MIDI Connector (15-pin Female)
4) PRINTER p. 25 Parallel (Printer) Port Connector (25-pin Female)
5) COM1, COM2 p. 25 Serial Port COM1 and COM2 (Two 9-pin Male)
6) VGA p. 25 VGA Compatible Connector (15-pin Female)
7) COM-OUT (optional) p. 25 Television Connector (RCA & 4-pin Female S-Video)
8) USB p. 26 Universal Serial BUS Ports 1 & 2 (Two 4-pin Female)
9) IR p. 26 Infrared Module
10) POWER p. 26 NLX Motherboard Power Connector (20-pin Block)
11) IDE1 p. 27 Primary IDE Connector (40-pin Block)
12) FLOPPY p. 27 Floppy Drive Connector (34-pin Block)
13. LAN_LED, WOL_ p. 27 LAN Activity Connectors (2-pin & 3-pin)
14) PAN_CON p. 28 Front Panel Display LEDs and Switches (16-1 pin)
15) MIC_CON p. 28 Front Panel Microphone Jack Connector (2 pin)
16) AMC p. 30 ATI Multimedia Connector (40-3 pin Block)
17) AUDIO p. 30 Back Panel Audio Connectors (10-1 pin Block)
18) CPU_FAN p. 30 CPU Fan Power (3-pin Block)
19) VGA Memory p. 31 Onboard VGA Memory Expansion Sockets (40 pins)
20) CDROM p. 31 CD-ROM Drive Connector (50-1 pins)

*The onboard hardware monitor uses the address 290H-297H so legacy ISA cards must not use this address or else conflicts will occur.

III. INSTALLATION

WARNING! Computer motherboards, baseboards and components, such as SCSI cards, contain very delicate Integrated Circuit (IC) chips. To protect them against damage from static electricity, you should follow some precautions whenever you work on your computer.

1. Unplug your computer when working on the inside.
2. Use a grounded wrist strap before handling computer components. If you do not have one, touch both of your hands to a safely grounded object or to a metal object, such as the power supply case.
3. Hold components by the edges and try not to touch the IC chips, leads or connectors, or other components.
4. Place components on a grounded antistatic pad or on the bag that came with the component whenever the components are separated from the system.

Installation Steps

Before using your computer, you must complete the following steps:

1. **Set Jumpers on the Motherboard (if necessary)**
2. **Install System Memory Modules**
3. **Install the Central Processing Unit (CPU)**
4. **Install Expansion Cards**
5. **Connect Ribbon Cables, Cabinet Wires, and Power Supply**
6. **Setup the BIOS Software**

1. Jumpers

1. Audio Setting (JP1)

This jumper allows you to enable or disable the onboard audio. This is normally set to enable unless you add an audio expansion card in which case you would need to disable the onboard audio to prevent hardware conflicts.

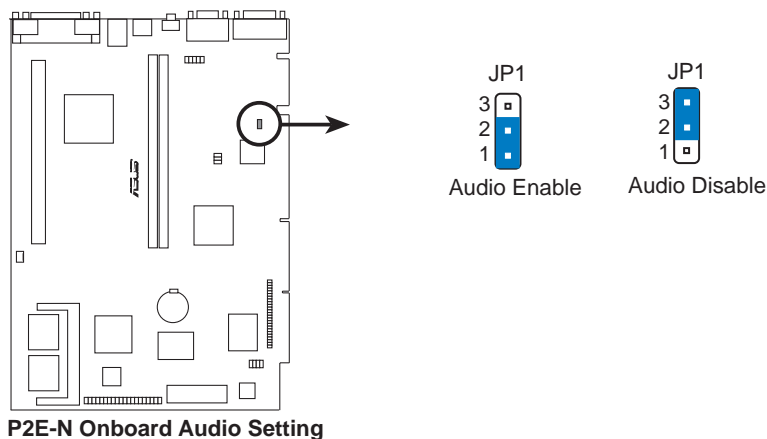

III. INSTALLATION

2. System Memory (DIMM)

Only Dual Inline Memory Modules (DIMM) can be used with this motherboard. Two sockets are available for **3.3Volt** (power level) Unbuffered Synchronous DRAMs (SDRAM) or EDO DRAM of either 8, 16, 32, 64, or 128MB. One side (with memory chips) of the DIMM module takes up one Row on the motherboard.

To utilize the chipset's Error Checking and Correction (ECC) feature, you must use a DIMM module with 9 chips per side (standard 8 chips/side + 1 parity chip) and make the proper settings in the BIOS Chipset Features Setup. (**NOTE:** ECC is only available on the P2L-N motherboard.)

IMPORTANT: Memory speed setup is required through "Auto Configuration" in BIOS Chipset Setup of the BIOS SOFTWARE.

WARNING: Memory modules must have 18 chips or less. Memory modules with more than 18 chips exceeds specifications and may cause unstable operation.

Install memory in any combination as follows:

DIMM Location	168-pin DIMM Memory Modules		Total Memory
Socket 1 (Rows 0&1)	SDRAM/EDO 8, 16, 32, 64, 128MB	x1	
Socket 2 (Rows 2&3)	SDRAM/EDO 8, 16, 32, 64, 128MB	x1	
	Total System Memory (Max 256MB)	=	

ASUS Memory Examples:



ECC EDO DIMM (9 chips)

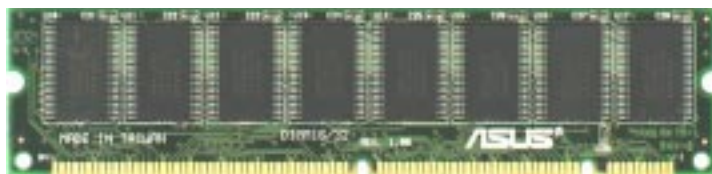

Non-ECC SDRAM DIMM (8 chips)

General DIMM Notes: (not true for all memory modules)

- Four possible memory chips are available: EDO or SDRAM with and without ECC.
- SDRAM chips are generally thinner with higher pin density than EDO chips.
- BIOS shows EDO or SDRAM memory on bootup screen.
- 8 chip/side modules do not support ECC, only 9 chip/side modules support ECC.
- Single sided modules are usually 16 or 64 MB, double sided are usually 8, 32, or 128MB.

III. INSTALLATION

DIMM Memory Installation

Insert the module(s) as shown. Because the number of pins are different on either side of the breaks, the module will only fit in the orientation as shown. DIMM modules are longer and have different pin contact on each side and therefore have a higher pin density. SIMM modules have the same pin contact on both sides.

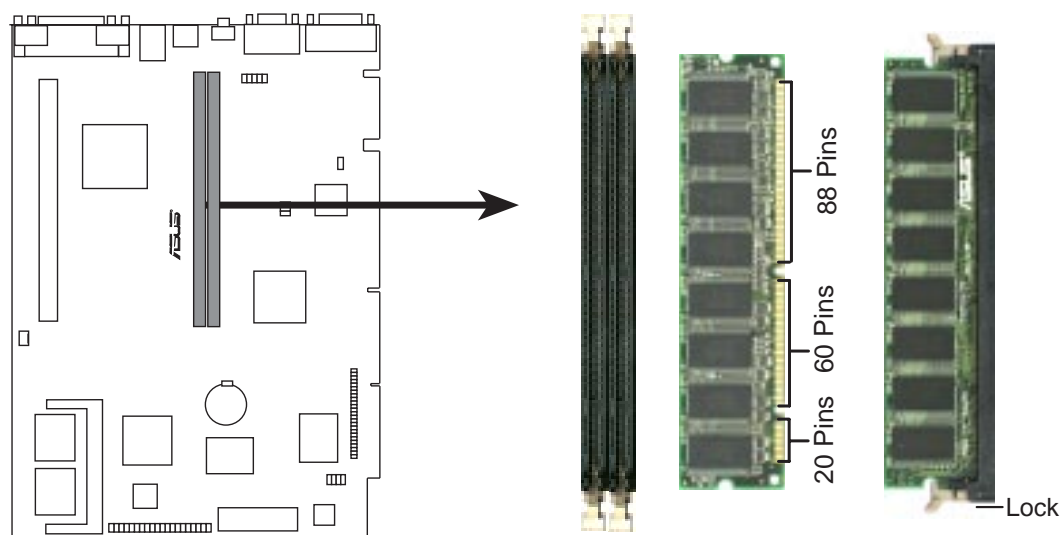

P2E-N 168 Pin DIMM Memory Sockets

The Dual Inline Memory Module (DIMM) must be **3.3V Unbuffered** for this motherboard. You can identify the type of DIMM module by the illustration below:

168-Pin DIMM Notch Key Definitions (3.3V)

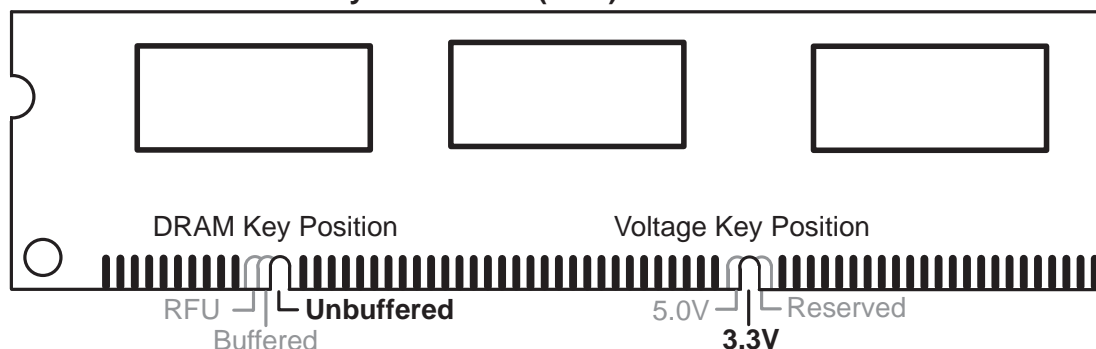

The notch on the DIMM module will shift between left, center, or right to identify the type and also to prevent the wrong type of DIMM to be inserted into the DIMM socket on the motherboard. Four clock signals are supported on this motherboard. You must ask your retailer for the specifications before purchasing memory modules.

III. INSTALLATION

3. Central Processing Unit (CPU)

This motherboard provides a Single Edge Contact (SEC) slot for a Pentium II processor packaged in an SEC cartridge.

Pentium II Processor

WARNING! Be sure that sufficient air is circulating across the processor's passive heatsink. Without sufficient circulation, the processor could overheat and damage both the processor and the motherboard. It is recommended that you install an auxiliary fan.

You should check to see that you have the following 9 items. (**NOTE:** The pictures in the following pages will have the same item numbers next to them for your reference. The design and color of your items may be slightly different.)

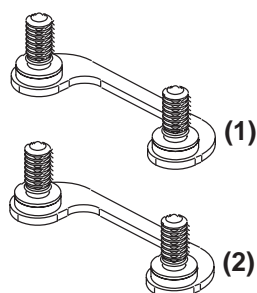

Attach Mount Bridges (Items 1,2)

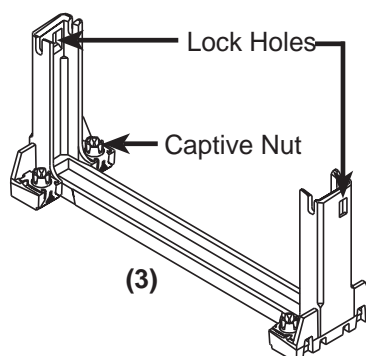

Pentium II Retention Mechanism (Item 3)

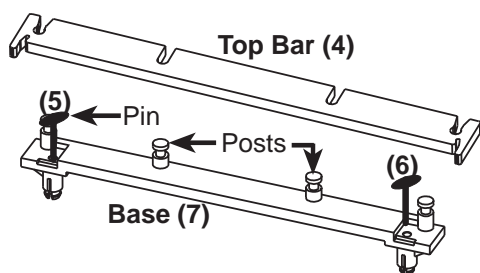

Heatsink Support Base/Top Bar (Items 4-7)

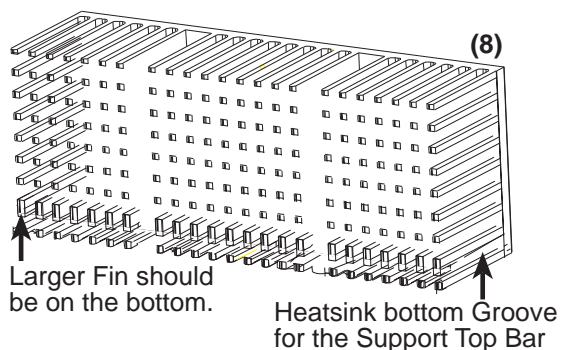

Pentium II Processor Heatsink (Item 8)



Intel Pentium II Processor in a SEC Cartridge
(233-333MHz 512KB/256KB/0KB L2 Cache)

CPU (Item 9)

III. INSTALLATION

The Motherboard As Shipped

Four screws should be showing next to each corner of the SEC CPU Slot using two attach mount bridges from the underside of the motherboard.

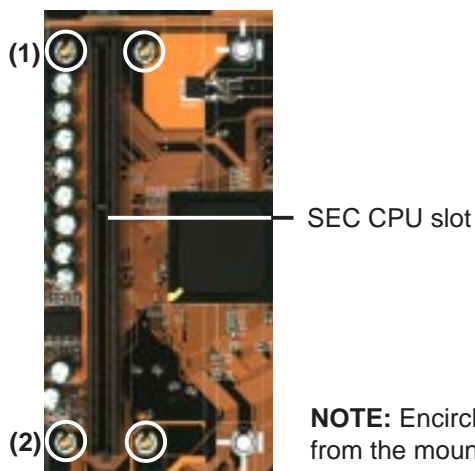

Installing the Pentium II Processor:

- 1. Mount the Pentium II Retention Mechanism:** The retention mechanism is designed to fit into the SEC slot only one way.

TIP: Orient the mechanism's lock holes toward the motherboard's chipsets (see motherboard layout for the location of the Intel chipset).

Be sure to align the notch in the mechanism with the small rib on one side of the slot and that the mechanism is properly seated on the board. Then, screw the captive nuts in place.

WARNING! Do not overtighten the captive nuts. Doing so could damage your motherboard. Tighten captive nuts to no more than 6 ± 1 inch/pound.

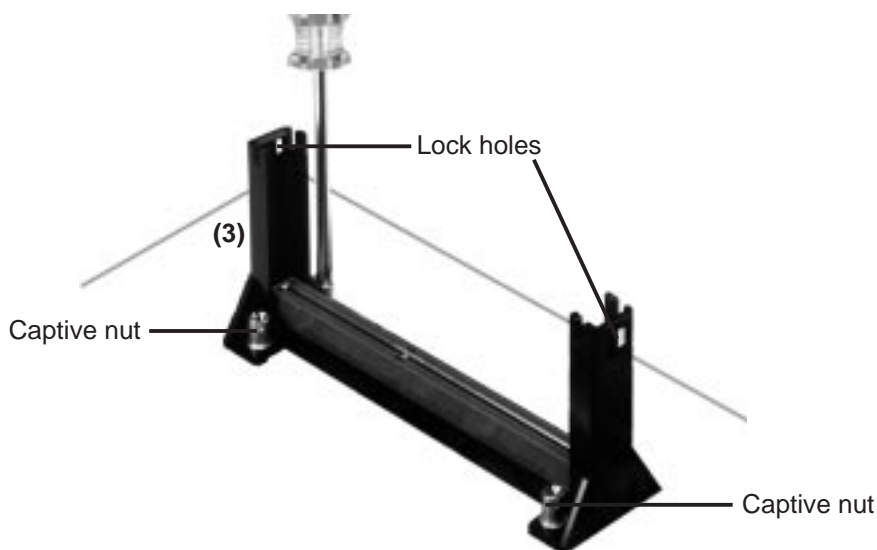

III. INSTALLATION

- 2. Mount the Heatsink:** Place the SEC cartridge face down on a flat surface and lay the heat sink flush on the back (metal side) of the SEC cartridge. Check the orientation of the heatsink against the pictures. The thicker fin must be orientated toward the bottom. The top clamp is wider than the bottom clamp so only this orientation will fit. With a screw driver, push the clamps one at a time into the SEC cartridge. Be sure that the heatsink is firmly pressed against the SEC cartridge. When correctly installed, no light must be showing through between the thermal pad of the heatsink and the SEC cartridge.

WARNING! If the heatsink is not mounted tightly against the SEC cartridge, the CPU will overheat. You may install an auxiliary fan to provide adequate circulation across the processor's passive heatsink.

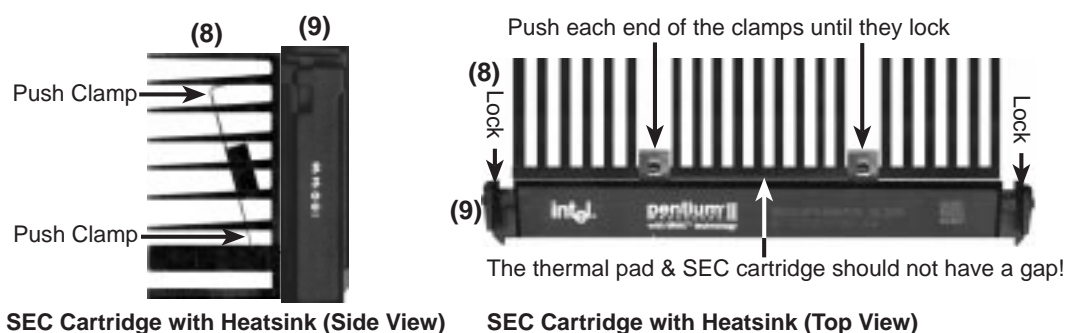

- 3. Insert the SEC Cartridge:** Push the SEC cartridge's two locks inward (the preceding picture shows the locks in the outward position and inward in the picture below). With the heatsink facing the motherboard's chipsets, press the cartridge gently but firmly until it is full inserted.

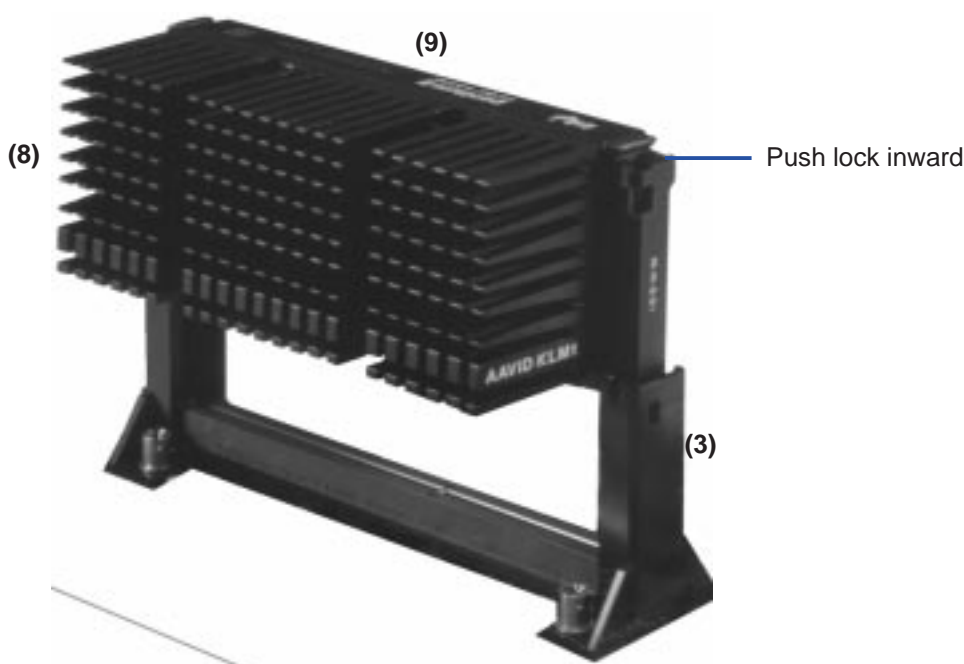

III. INSTALLATION

- Secure the SEC Cartridge:** Secure the SEC cartridge in place by pushing the SEC cartridge locks outward so that the lock shows through the retention mechanism's lock holes.

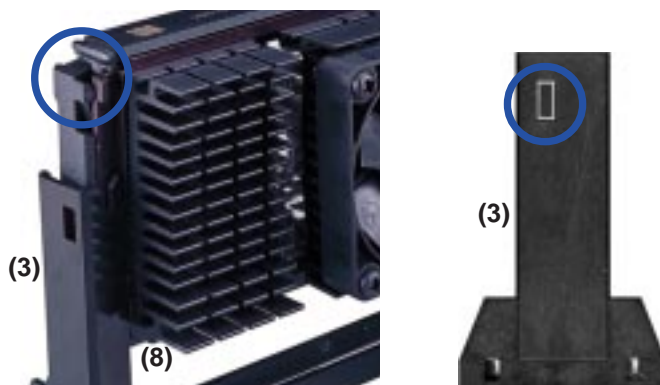

- Secure the Heatsink:** Install the heatsink support base into the motherboard. This is not, however, necessary if you use a heatsink with fan (see next page). The support base is necessary to secure the heatsink (without fan). Secure the heatsink by sliding the heatsink support top bar into the bottom groove of the heatsink until it locks into the heatsink support base posts.

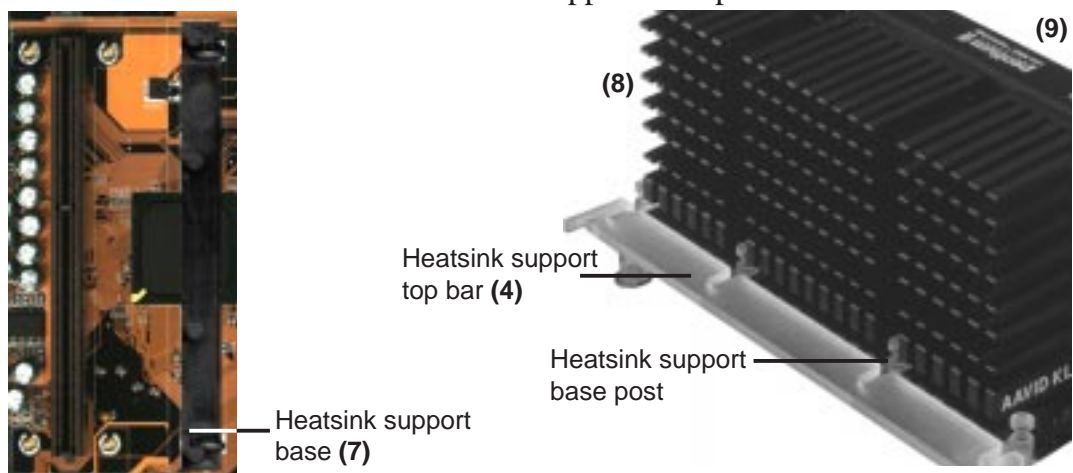

- Attach the Thermal Sensor Connector (optional):** If you have purchased the specially designed fan and thermal monitor heatsink, you can connect the thermal sensor wire to the motherboard through this connector.

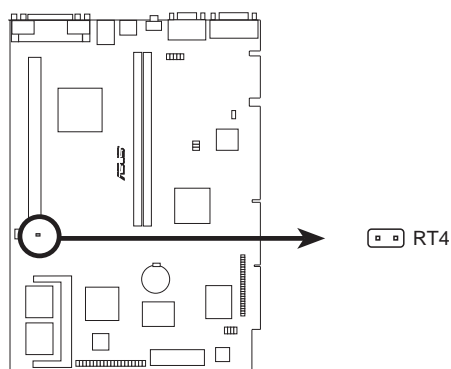

P2E-N CPU Thermal Sensor Connector

III. INSTALLATION

The heatsinks shown in this manual are for reference purposes only. The recommended heatsinks for the Pentium II processor are those with three-pin fans that can be connected to the CPU fan connector on motherboard. These heatsinks have the added benefits of proper heat dissipation and with the hardware monitor, the ability to monitor the fan's RPM and use the alert function through the included LANDesk Client Manager (LDCM) software.

AAVID Heatsink



The procedures for installing the AAVID heatsink with fan is similar as that for the heatsink without a fan. You will not, however, be able to use the heatsink support top bar because of the fan. The heatsink support top bar will, however, still be included in the package, in case you use a heatsink without a fan.

Elan Vital Heatsink



The procedures for installing the Elan Vital heatsink with fan is also similar as that for the heatsink without a fan. The Elan Vital heatsink, however, comes with a lever to clamp the heatsink into the SEC cartridge. Mount the heatsink in the orientation as shown then flip the lever from "Unlock" to "Lock." You will not be able to also use the heatsink support top bar because of the fan. The heatsink support top bar will, however, still be included in the package, in case you use a heatsink without a fan.

III. INSTALLATION

4. Expansion Cards

WARNING! Unplug your power supply when adding or removing expansion cards or other system components. Failure to do so may cause severe damage to both your motherboard and expansion cards.

Expansion Card Installation Procedure

1. Read the documentation for your expansion card and make any necessary hardware or software settings for your expansion card, such as jumpers.
2. Remove your computer system's cover and the bracket plate on the slot you intend to use. Keep the bracket for possible future use.
3. Carefully align the card's connectors and press firmly.
4. Secure the card on the slot with the screw you removed above.
5. Replace the computer system's cover.
6. Set up the BIOS if necessary
(such as *IRQ xx Used By ISA: Yes* in PNP AND PCI SETUP)
7. Install the necessary software drivers for your expansion card.

Assigning IRQs for Expansion Cards

Some expansion cards need to use an IRQ to operate. Generally an IRQ must be exclusively assigned to one use. In a standard design there are 16 IRQs available but most of them are already in use, leaving 6 IRQs free for expansion cards.

Both ISA and PCI expansion cards may require to use IRQs. System IRQs are available to cards installed in the ISA expansion bus first, then any remaining IRQs are available to PCI cards. Currently, there are two types of ISA cards. The original ISA expansion card design, now referred to as legacy ISA cards, requires that you configure the card's jumpers manually and then install it in any available slot on the ISA bus. You may use Microsoft Diagnostics (MSD.EXE) utility located in the Windows directory to see a map of your used and free IRQs. If you use Windows 95, the **Resources** tab under **Device Manager** displays the resource settings being used by a particular device (to gain access, double-click the **System** icon under the **Control Panel** program). Ensure that no two devices share the same IRQs or your computer will experience problems when those two devices are in use at the same time.

The original ISA expansion card design, now referred to as "Legacy" ISA cards, requires that you configure the card's jumpers manually and then install it in any available slot on the ISA bus. You may use Microsoft's Diagnostic (MSD.EXE) utility included in the Windows directory to see a map of your used and free IRQs. For Windows 95 users, the "Control Panel" icon in "My Computer," contains a "System" icon which gives you a "Device Manager" tab. Double clicking on a specific device give you "Resources" tab which shows the Interrupt number and address. Make sure that no two devices use the same IRQs or your computer will experience problems when those two devices are in use at the same time.

III. INSTALLATION

The original ISA expansion card design, now referred to as “Legacy” ISA cards, requires that you configure the card’s jumpers manually and then install it in any available slot on the ISA bus. You may use Microsoft’s Diagnostic (MSD.EXE) utility included in the Windows directory to see a map of your used and free IRQs. For Windows 95 users, the “Control Panel” icon in “My Computer,” contains a “System” icon which gives you a “Device Manager” tab. Double clicking on a specific device give you “Resources” tab which shows the Interrupt number and address. Make sure that no two devices use the same IRQs or your computer will experience problems when those two devices are in use at the same time.

To simplify this process this motherboard has complied with the Plug and Play (PNP) specification which was developed to allow automatic system configuration whenever a PNP-compliant card is added to the system. For PNP cards, IRQs are assigned automatically from those available.

If the system has both Legacy and PNP ISA cards installed, IRQs are assigned to PNP cards from those not used by Legacy cards. The PCI and PNP configuration of the BIOS setup utility can be used to indicate which IRQs are being used by Legacy cards. For older Legacy cards that does not work with the BIOS, you can contact your vendor for an ISA Configuration Utility.

An IRQ number is automatically assigned to PCI expansion cards after those used by Legacy and PNP ISA cards. In the PCI bus design, the BIOS automatically assigns an IRQ to a PCI slot that has a card in it that requires an IRQ. To install a PCI card, you need to set something called the INT (interrupt) assignment. Since all the PCI slots on this motherboard use an INTA #, be sure that the jumpers on your PCI cards are set to INT A.

Assigning DMA Channels for ISA Cards

Some ISA cards, both legacy and PnP, may also need to use a DMA (Direct Memory Access) channel. DMA assignments for this motherboard are handled the same way as the IRQ assignment process described earlier. You can select a DMA channel in the PCI and PnP configuration section of the BIOS Setup utility.

IMPORTANT: To avoid conflicts, reserve the necessary IRQs and DMAs for legacy ISA cards (under PNP AND PCI SETUP of the BIOS SOFTWARE, choose *Yes* in *IRQ xx Used By ISA* and *DMA x Used By ISA* for those IRQs and DMAs you want to reserve).

ISA Cards and Hardware Monitor

The onboard hardware monitor uses the address 290H-297H so legacy ISA cards must not use this address or else conflicts will occur.

III. INSTALLATION

5. External Connectors

WARNING! Some pins are used for connectors or power sources. These are clearly separated from jumpers in “Map of the Motherboard.” Placing jumper caps over these will cause damage to your motherboard.

IMPORTANT: Ribbon cables should always be connected with the red stripe on the Pin 1 side of the connector. The four corners of the connectors are labeled on the motherboard. Pin 1 is the side closest to the power connector on hard drives and floppy drives. IDE ribbon cable must be less than 18in. (46cm), with the second drive connector no more than 6in. (15cm) from the first connector.

1. PS/2 Keyboard Connector (6 pin Female)

This connector is for a standard keyboard using an PS/2 plug (mini DIN). **This connector will not allow standard AT size (large DIN) keyboard plugs. You may use a DIN to mini DIN adapter on standard AT keyboards.**

2. PS/2 Mouse Connector (6 pin Female)

The system will direct IRQ12 to the PS/2 mouse if one is detected. If not detected, expansion cards can use IRQ12. See “PS/2 Mouse Control” in BIOS Features Setup of the BIOS SOFTWARE.

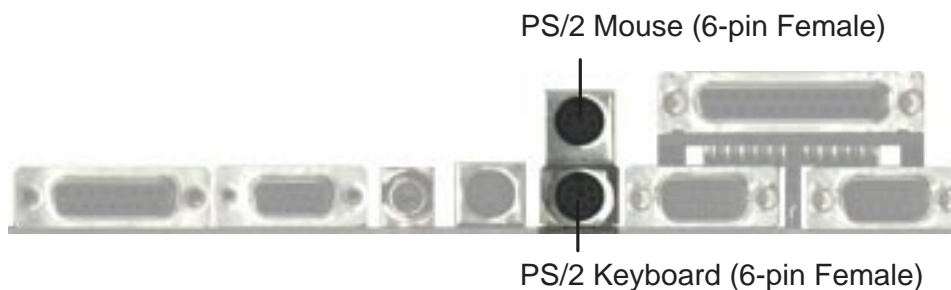

3. Joystick/MIDI Connector (15 pin Female)

This connector is for a standard joystick or MIDI device.



III. INSTALLATION

4. Parallel Printer Connector (25 pin Female)

You can enable the parallel port and choose the IRQ through “Onboard Parallel Port” in Chipset Features Setup of the BIOS SOFTWARE. **NOTE:** Serial printers must be connected to the serial port.

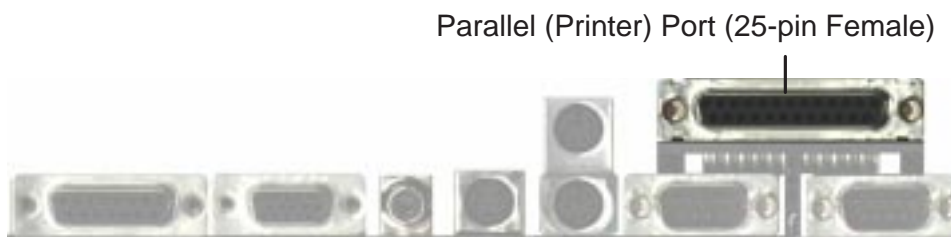

5. Serial Port COM1 and COM2 Connectors (Two 9 pin Male)

The two serial ports can be used for pointing devices or other serial devices. See “Onboard Serial Port” in Chipset Features Setup of the BIOS SOFTWARE.



6. VGA Connector (15 pin Female)

This connector is for displaying on a standard VGA-compatible device.

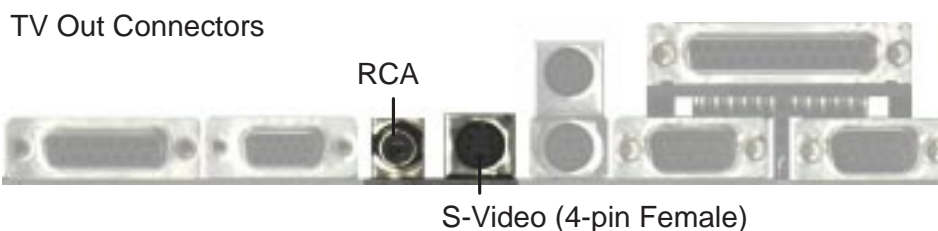

7. TV Out Connectors (RCA and 4 pin Female S-Video) (optional)

These connectors are for displaying on a television using the RCA connector or the S-Video connector.

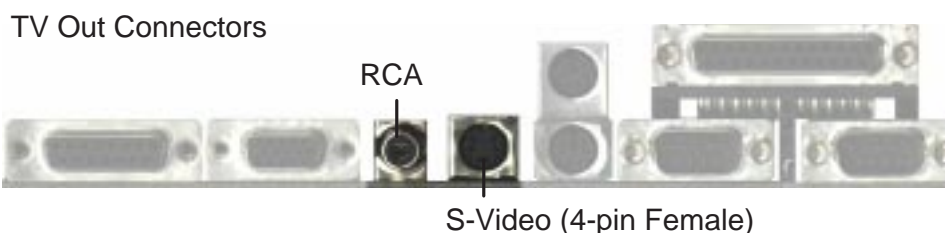

III. INSTALLATION

8. Universal Serial BUS Ports 1 & 2 (Two 4 pin Female Sockets)

Two USB ports are available for connecting USB devices.

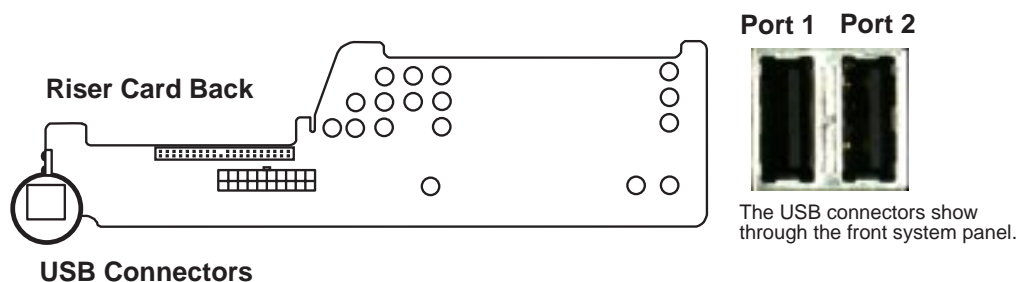

9. IrDA / Fast IR-Compliant Infrared Module

This is an onboard infrared module for wireless transmitting and receiving data through the front panel infrared lens.

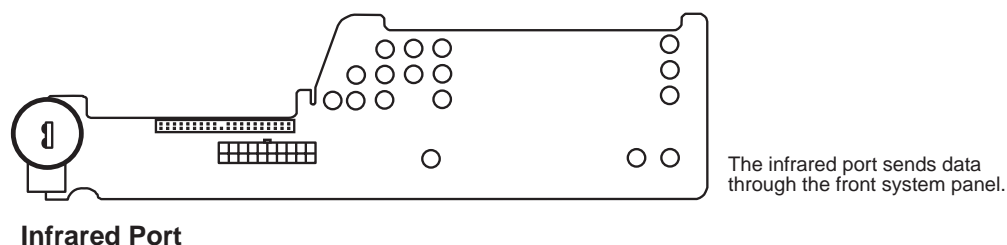

10. NLX Power Supply Connector (20 pin NLXPWR)

This connector connects to an NLX power supply. The plug from the power supply will only insert in one orientation because of the different hole sizes. Find the proper orientation and push down firmly making sure that the pins are aligned.

IMPORTANT: Be sure that the NLX power supply can deliver at least 720mAmp on the 5volt standby lead (5VSB). You may experience difficulty in powering on your system without this specification.

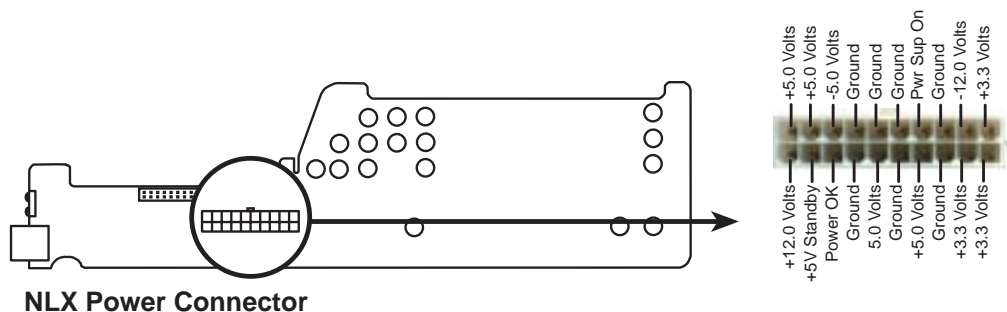

III. INSTALLATION

11. Primary IDE Connector (40-1 pin IDE)

This connector supports the provided IDE hard disk drive ribbon cable. After connecting one end to the riser card, connect the other end to a hard disk drive. The primary IDE channel supports both a master and a slave IDE device but the system housing size only permits a standard IDE hard drive to be installed.

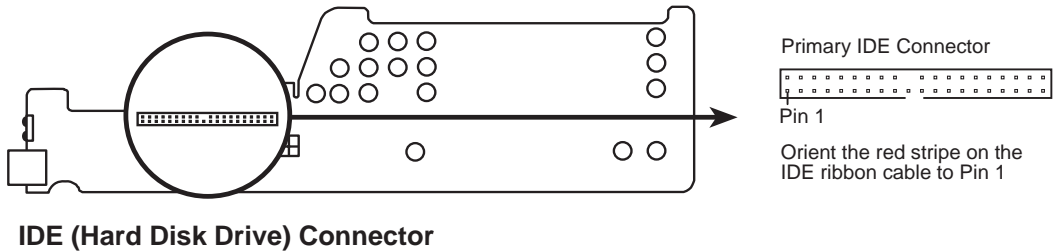

12. 3.5inch Floppy Disk Drive Connector (34-1 pin FLOPPY)

This connector supports the provided floppy drive ribbon cable. After connecting the single end to the riser card, connect the other end to a 3.5inch floppy disk drive.

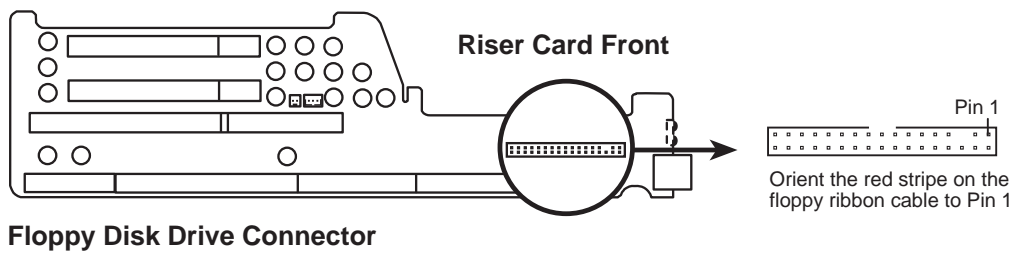

13. LAN Activity Connectors (2 pin LAN_LED & 3 pin WOL_CON)

These connectors support Local Area Network (LAN) cards such as the ASUS PCI-L101 with output signals for data transfer activity. The LAN_LED connector allows the front panel LED to blink during transfer activity between the network and the computer. The WOL_CON connector allows the system to power up when there is a wakeup package (signal) received from the network.

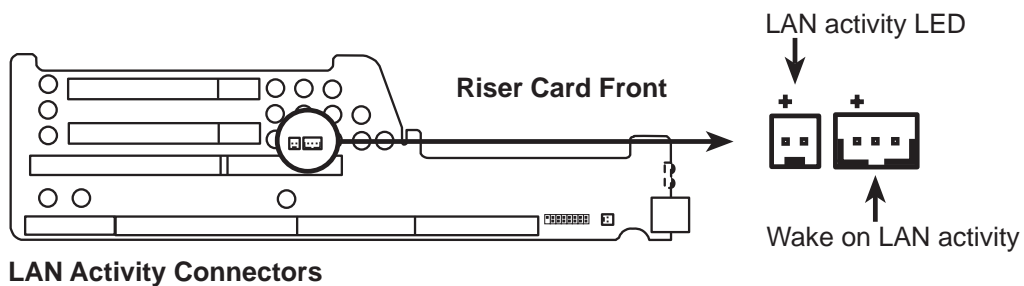

III. INSTALLATION

14. Riser Front Panel Connector (16-1 pin)

This connector is used to connect the front panel display LED's and buttons to the motherboard through a ribbon cable.

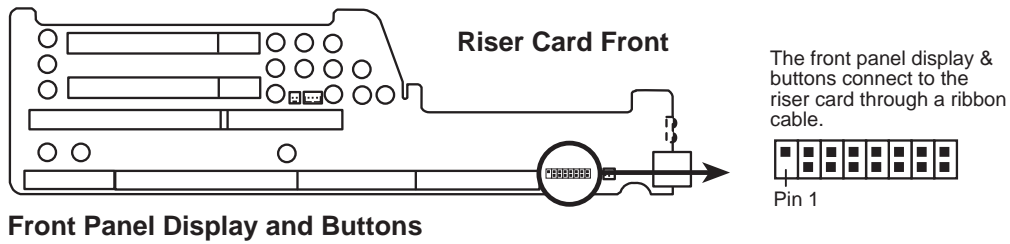

15. Riser Front Panel Microphone Connector (2 pin)

This connector is used to connect the front panel microphone jack to the motherboard through a ribbon cable.

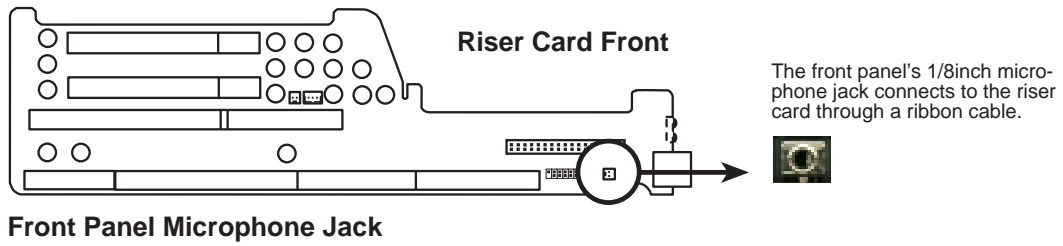

III. INSTALLATION

Front Panel Descriptions

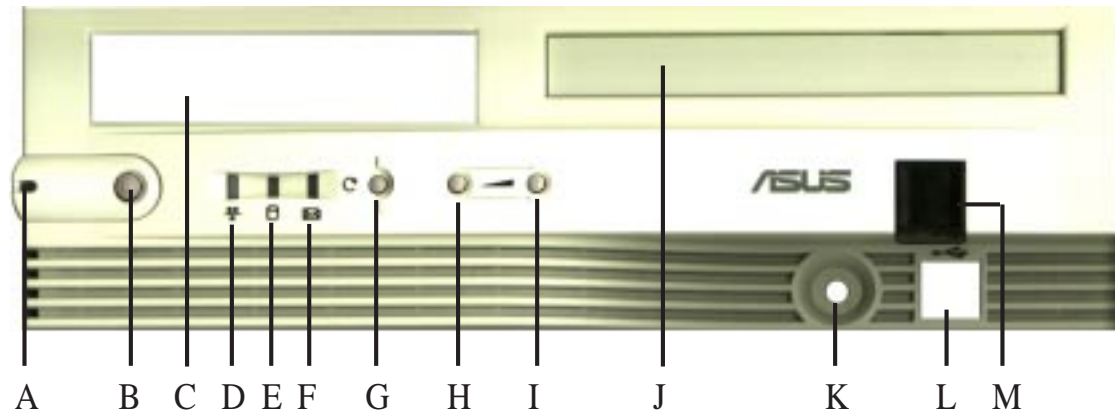

A. System Power LED

Lights when the system is powered on and blinks when it is in sleep mode.

B. NLX Power Button/ Soft Power Button

Switches between ON, OFF, and SLEEP mode. The functions are controlled and configurable through the “Power Up Control” in the POWER MANAGEMENT SETUP of the BIOS SOFTWARE.

C. Floppy Drive Bay

Accepts a standard 3.5inch floppy drive, LS-120, or other compatible devices.

D. Network Activity LED

Blinks when data is transferred to or from a network card. (The network card requires an external LED wire connected to the Riser card’s LAN_LED.)

E. IDE Activity LED

Blinks when data is transferred via the IDE channels, includes the CD-ROM.

F. Message LED

The LED will remain lit when there is no modem activity and blink when there is data being transferred or waiting in the inbox. Requires ACPI OS support.

G. Reset Button

Switch used for rebooting the computer without having to use the power switch

H. Volume Down Button

Decreases the onboard audio amplifier’s volume.

I. Volume Up Button

Increases the onboard audio amplifier’s volume.

J. CD-ROM Drive Bay

Accepts only a notebook-size CD-ROM.

K. Microphone Jack

Accepts a 1/8inch connector from a microphone or other audio source.

L. USB Port1 and Port2

Accepts 15 USB devices on each port.

M. Infrared Window

Allows transmission and reception of infrared signals by the onboard module.

III. INSTALLATION

16. ATI Multimedia Connector (40-3 pin AMC)

This connector is used for ATI video accessories such as video capture cards or television tuners.

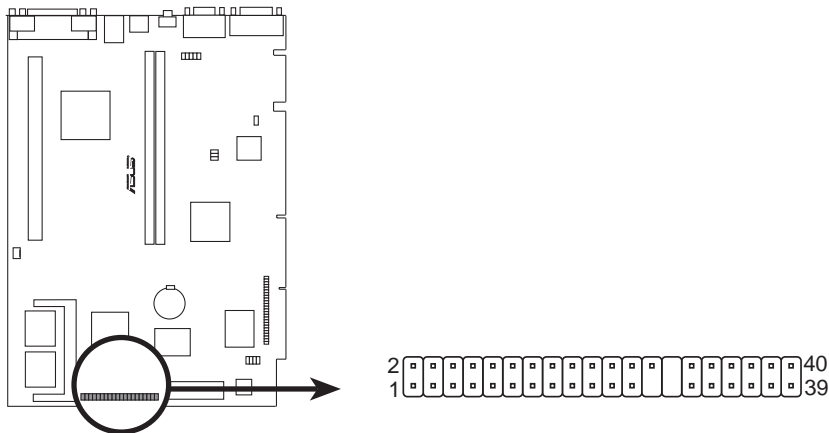

P2E-N ATI Multimedia Connector

17. Audio Connectors (Three 1/8inch. Female)

These connectors are provided for audio input and output signals.

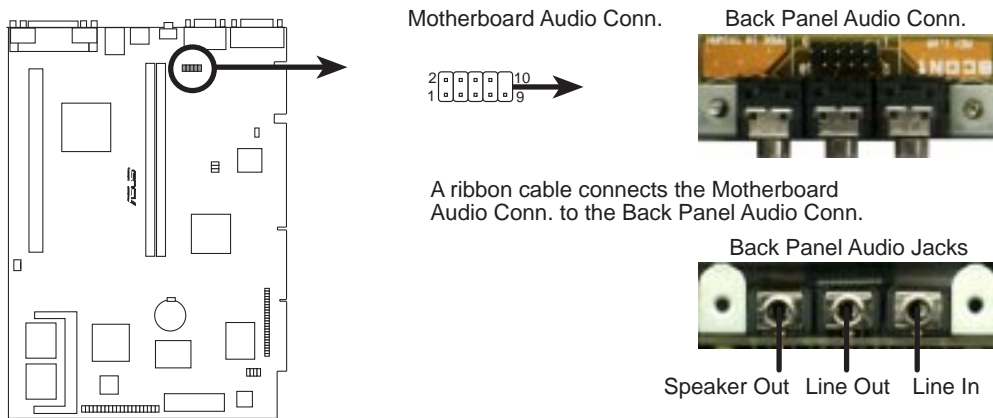

P2E-N Audio Jack Connector

18. CPU Fan Connector (3 pin)

This connector support a cooling fan of 500mAMP (6WATT) or less.

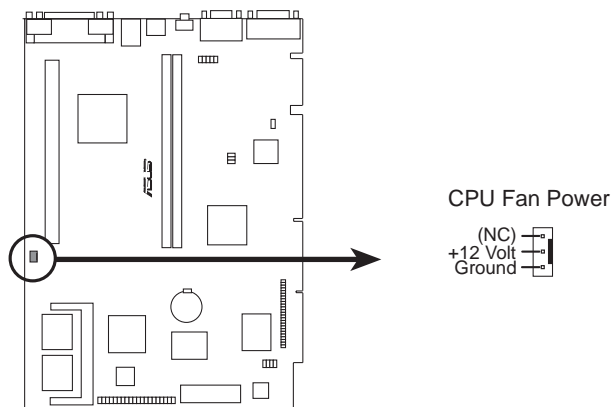

P2E-N 12Volt Cooling Fan Power

III. INSTALLATION

19. VGA Memory Socket (SO-DIMM)

At the time of purchase, you may select either 4MB SGRAM VGA memory onboard, 2MB, or 0MB model. If you wish to upgrade the 4MB model, add a 2x2MB SGRAM chip SO-DIMM for 8MB total. If you wish to upgrade the 2MB, add either a 2x1MB SGRAM chip SO-DIMM or 4x1MB for either 4MB or 6MB total. If you wish to upgrade the 0MB model, only a 4x2MB SDRAM SO-DIMM can be used for 8MB SDRAM total.

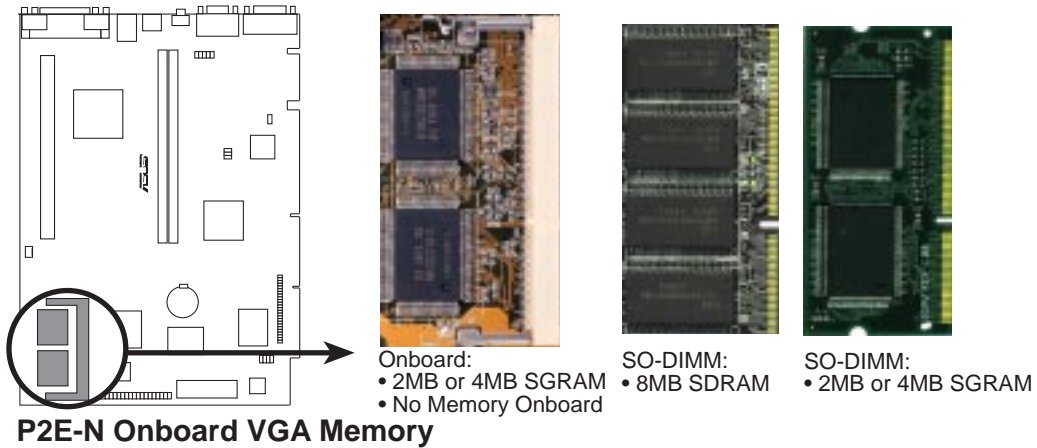

20. CD-ROM Connector (50-1 pin CDROM)

This is a proprietary CD-ROM connector which requires a converter in order to attach to a slim CD-ROM. Only a slim CD-ROM will fit in the NLX system housing.

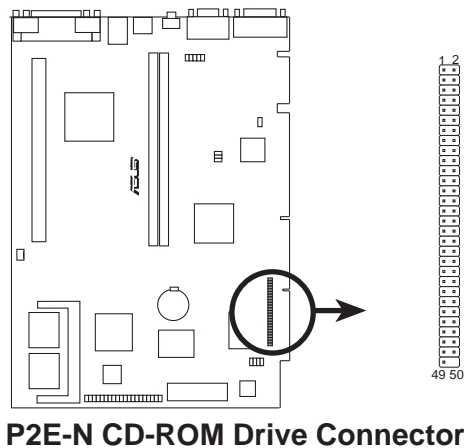

(This page was intentionally left blank)

III. INSTALLATION

Power Connection Procedures

1. After all connections are made, close the system case cover.
 2. Be sure that all switches are off (in some systems, marked with ○).
 3. Connect the power supply cord into the power supply located on the back of your system case according to your system user's manual.
 4. Connect the power cord into a power outlet that is equipped with a surge protector.
 5. You may then turn on your devices in the following order:
 - a. Your monitor
 - b. External SCSI devices (starting with the last device on the chain)
 - c. Your system power. For ATX power supplies, you need to switch on the power supply as well as press the ATX power switch on the front of the case.
 6. The power LED on the front panel of the system case will light. For ATX power supplies, the system LED will light when the ATX power switch is pressed. The monitor LED may light up after the system's if it complies with "green" standards or if it has a power standby feature. The system will then run power-on tests. While the tests are running, additional messages will appear on the screen. If you do not see anything within 30 seconds from the time you turn on the power, the system may have failed a power-on test. Recheck your jumper settings and connections or call your retailer for assistance.
 7. During power-on, hold down <Delete> to enter BIOS setup. Follow the instructions in the next section, BIOS SOFTWARE.
- * **Powering Off your computer:** You must first exit or shut down your operating system before switching off the power switch. For ATX power supplies, you can press the ATX power switch after exiting or shutting down your operating system. If you use Windows 95, click the **Start** button, click **Shut Down**, and then click **Shut down the computer?**. The system will give three quick beeps after about 30 seconds and then power off after Windows shuts down.

NOTE: The message "You can now safely turn off your computer" will not appear when shutting down with ATX power supplies.

IV. BIOS SOFTWARE

Support Software

AFLASH.EXE: This is the Flash Memory Writer utility that updates the BIOS by uploading a new BIOS file to the programmable flash ROM chip on the motherboard. To determine the BIOS version of your motherboard, check the last four numbers of the code displayed on the upper left-hand corner of your screen during bootup. Larger numbers represent a newer BIOS file. This file works only in DOS mode.

NOTE: The following screen displays are provided as examples only and may not reflect the screen contents displayed on your system.

Flash Memory Writer Utility

```
ASUS ACPI BIOS
FLASH MEMORY WRITER V1.0
Copyright (C) 1994-98, ASUSTek COMPUTER INC.

Flash Memory: 4MEL 0729C0109

Current BIOS Version: ASUS P2E-M ACPI BIOS Revision 1000 Beta 005
Chipset and Model   : 1640DA-P2E-M
BIOS Build Date    : 06/21/98

Choose one of the following:

1. Save Current BIOS To File
2. Update BIOS Including Boot Block and ESCD

Enter choice: [1]

Press ESC To Exit
```

IMPORTANT! If “unknown” is displayed after **Flash Memory:**, the memory chip is either not programmable or is not supported by the ACPI BIOS and therefore, cannot be programmed by the Flash Memory Writer utility.

Main Menu

1. Save Current BIOS To File

This option allows you to save a copy of the original motherboard BIOS in case you need to reinstall it. It is recommended that you save **AFLASH.EXE** and the BIOS file to a bootable floppy disk.

```
Save Current BIOS To File

Flash Memory: 4MEL 0729C0109

Current BIOS Version: ASUS P2E-M ACPI BIOS Revision 1000 Beta 005
Chipset and Model   : 1640DA-P2E-M
BIOS Build Date    : 06/21/98

Please Enter File Name to Save: A:\440XX-1
```

To save your current BIOS, type [1] at the **Main Menu** and then press <Enter>. The **Save Current BIOS To File** screen appears. Type a filename and the path, for example, **A:\440XX-1** and then press <Enter>.

IV. BIOS SOFTWARE

2. Update BIOS Including Boot Block and ESCD

This option updates the boot block, the baseboard BIOS, and the ACPI extended system configuration data (ESCD) parameter block from a new BIOS file. See the next page for procedures on downloading an updated BIOS file.

To update your current BIOS, type [2] at the **Main Menu** and then press <Enter>. The **Update BIOS Including Boot Block and ESCD** screen appears. Type the filename of your new BIOS and the path, for example, **A:\XX2I1002.AWD**, and then press <Enter>.

When prompted to confirm the BIOS update, press **Y** to start the update.

The utility starts to program the new BIOS information into the flash ROM. When the programming is finished, *Flashed Successfully* will be displayed.

Follow the onscreen instructions to continue.

```
Update BIOS Including Boot Block and ESCD
Flash Memory:  ATHEL-RT250C0100
Current BIOS Version:  ASUS P2E-M ACPI BIOS Revision 1002 Beta 005
Chipset and Model    :  I440EX-P2E-M
BIOS Build Date     :  04/21/98
Please Enter File Name for NEW BIOS: 1002DM.000
```

```
Update BIOS Including Boot Block and ESCD
Flash Memory:  ATHEL-RT250C0100
BIOS Version
I CURRENT I ASUS P2E-M ACPI BIOS Revision 1002 Beta 005
I 1002DM.000 I ASUS P2E-M ACPI BIOS Revision 1002 Beta 005
Chipset and Model
I CURRENT I I440EX-P2E-M
I 1002DM.000 I I440EX-P2E-M
Date of BIOS Build
I CURRENT I 04/21/98
I 1002DM.000 I 04/27/98
Are you sure (Y/N) ? (Y)

Press ESC To Return to Main Menu
```

```
Update BIOS Including Boot Block and ESCD
Flash Memory:  ATHEL-RT250C0100
BIOS Version
I CURRENT I ASUS P2E-M ACPI BIOS Revision 1002 Beta 005
I 1002DM.000 I ASUS P2E-M ACPI BIOS Revision 1002 Beta 005
Chipset and Model
I CURRENT I I440EX-P2E-M
I 1002DM.000 I I440EX-P2E-M
Date of BIOS Build
I CURRENT I 04/21/98
I 1002DM.000 I 04/27/98
Programming -- 1FFF
Flashed Successfully
Press ESC To Continue
```

```
ASUS ACPI BIOS
Flash Memory Writer V1.0
Copyright (C) 1994-99, ASUSTek COMPUTER INC.
Flash Memory:  ATHEL-RT250C0100
Current BIOS Version:  ASUS P2E-M ACPI BIOS Revision 1002 Beta 005
Chipset and Model    :  I440EX-P2E-M
BIOS Build Date     :  04/21/98
Choose one of the followings:
1. Save Current BIOS To File
2. Update BIOS Including Boot Block and ESCD
Enter choice: 11
You have flashed the EPROM! It is recommended that you turn off
the power, enter SETUP and Load Setup Defaults to have CMOS
updated with new BIOS when exits.
Press ESC To Exit
```

IV. BIOS SOFTWARE

Managing and Updating Your Motherboard's BIOS

Upon First Use of the Computer System

1. Create a bootable system floppy disk by typing [FORMAT A:/S] from the DOS prompt without creating "AUTOEXEC.BAT" and "CONFIG.SYS" files.
2. Copy AFLASH.EXE to the just created boot disk.
3. Run AFLASH.EXE from this new disk and select option **1. Save Current BIOS to File**. See **1. Save Current BIOS To File** on the previous page for more details and the rest of the steps.

Updating BIOS Procedures (only when necessary)

1. Download an updated ASUS BIOS file from the Internet (WWW or FTP) or a BBS (Bulletin Board Service) (see ASUS CONTACT INFORMATION on page 3 for details) and save to the disk you created earlier.
2. Boot from the disk you created earlier.
3. At the "A:\>" prompt, type **AFLASH** and then press <Enter>.
4. At the **Main Menu**, type **2** and then press <Enter>. See **2. Update BIOS Including Boot Block and ESCD** on the previous page for more details and the rest of the steps.

WARNING! If you encounter problems while updating the new BIOS, DO NOT turn off your system since this might prevent your system from booting up. Just repeat the process, and if the problem still persists, update the original BIOS file you saved to disk above. If the Flash Memory Writer utility was not able to successfully update a complete BIOS file, your system may not be able to boot up. If this happens, your system will need service.

IV. BIOS SOFTWARE

6. BIOS Setup

The motherboard supports two programmable Flash ROM chips: 5 Volt and 12 Volt. Either of these memory chips can be updated when BIOS upgrades are released. Use the Flash Memory Writer utility to download the new BIOS file into the ROM chip as described in detail in this section.

All computer motherboards provide a Setup utility program for specifying the system configuration and settings. If your motherboard came in a computer system, the proper configuration entries may have already been made. If so, invoke the Setup utility, as described later, and take note of the configuration settings for future reference; in particular, the hard disk specifications.

If you are installing the motherboard, reconfiguring your system or you receive a Run Setup message, you will need to enter new setup information. This section describes how to configure your system using this utility.

The BIOS ROM of the system stores the Setup utility. When you turn on the computer, the system provides you with the opportunity to run this program. This appears during the Power-On Self Test (POST). Press <Delete> to call up the Setup utility. If you are a little bit late pressing the mentioned key(s), POST will continue with its test routines, thus preventing you from calling up Setup. If you still need to call Setup, reset the system by pressing <Ctrl> + <Alt> + <Delete>, or by pressing the Reset button on the system case. You can also restart by turning the system off and then back on again. But do so only if the first two methods fail.

When you invoke Setup, the CMOS SETUP UTILITY main program screen will appear with the following options:



NOTE: The following BIOS screens and descriptions were intended for the BIOS version at the time of product release. Your BIOS version may be slightly different.

IV. BIOS SOFTWARE

Load Defaults

The “Load BIOS Defaults” option loads the minimum settings for troubleshooting. “**Load Setup Defaults**”, on the other hand, is for loading optimized defaults for regular use. Choosing defaults at this level, will modify all applicable settings.

A section at the bottom of the above screen displays the control keys for this screen. Take note of these keys and their respective uses. Another section just below the control keys section displays information on the currently highlighted item in the list.

Standard CMOS Setup

This “Standard CMOS Setup” option allows you to record some basic system hardware configuration and set the system clock and error handling. If the motherboard is already installed in a working system, you will not need to select this option anymore. However, if the configuration stored in the CMOS memory on the board gets lost or damaged, or if you change your system hardware configuration, you will need to respecify the configuration values. The configuration values usually get lost or corrupted when the power of the onboard CMOS battery weakens.

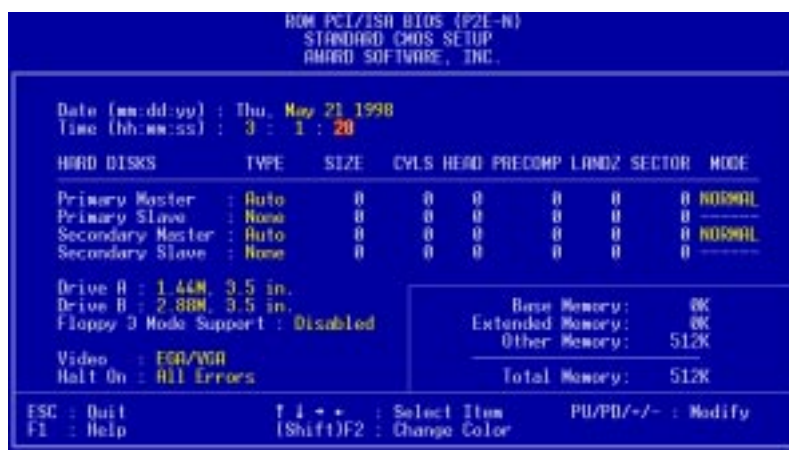

The preceding screen provides you with a list of options. At the bottom of this screen are the control keys for this screen. Take note of these keys and their respective uses.

User-configurable fields appear in a different color. If you need information on the selected field, press <F1>. The help menu will then appear to provide you with the information you need. The memory display at the lower right-hand side of the screen is read-only and automatically adjusts accordingly.

Details of Standard CMOS Setup:

Date

To set the date, highlight the “Date” field and then press either <Page Up>/<Page Down> or <+>/<-> to set the current date. Follow the month, day and year format. Valid values for month, day and year are: **Month: (1 to 12), Day: (1 to 31), Year: (up to 2079)**

IV. BIOS SOFTWARE

Time

To set the time, highlight the “Time” field and then press either <Page Up>/<Page Down> or <+>/<-> to set the current time. Follow the hour, minute and second format. Valid values for hour, minute and second are: (**Hour: (00 to 23)**), (**Minute: (00 to 59)**), (**Second: (00 to 59)**). Press <Enter> twice if you do not want to modify the current time.

NOTE: You can bypass the date and time prompts by creating an AUTOEXEC.BAT file. For information on how to create this file, please refer to the MS-DOS manual.

Hard Disks

This field records the specifications for all non-SCSI hard disk drives installed in your system. The onboard PCI IDE connectors provide Primary and Secondary channels for connecting up to four IDE hard disks or other IDE devices. Each channel can support up to two hard disks; the first of which is the “master” and the second is the “slave”.

Specifications for SCSI hard disks need not to be entered here since they operate using device drivers and are not supported by any the BIOS. If you install either the optional PCI-SC200 or PCI-SC860 SCSI controller card into the motherboard, see section VI for instructions. If you install other vendor’s SCSI controller card, refer to their respective documentations on how to install the required SCSI drivers.

For IDE hard disk drive setup, you can:

- Use the *Auto* setting for detection during bootup.
- Use the IDE HDD AUTO DETECTION in the main menu to automatically enter the drive specifications.
- Enter the specifications yourself manually by using the “User” option.

The entries for specifying the hard disk type include **CYLS** (number of cylinders), **HEAD** (number of read/write heads), **PRECOMP** (write precompensation), **LANDZ** (landing zone), **SECTOR** (number of sectors) and **MODE**. The **SIZE** field automatically adjusts according to the configuration you specify. The documentation that comes with your hard disk should provide you with the information regarding the drive specifications.

The **MODE** entry is for IDE hard disks only, and can be ignored for MFM and ESDI drives. This entry provides three options: *Normal*, *Large*, *LBA*, or *Auto* (see below). Set **MODE** to the *Normal* for IDE hard disk drives smaller than 528MB; set it to *LBA* for drives over 528MB that support Logical Block Addressing (LBA) to allow larger IDE hard disks; set it to *Large* for drives over 528MB that do not support LBA. *Large* type of drive can only be used with MS-DOS and is very uncommon. Most IDE drives over 528MB support the *LBA* mode.

IV. BIOS SOFTWARE

Auto detection of hard disks on bootup

For each field: Primary Master, Primary Slave, Secondary Master, and Secondary Slave, you can select *Auto* under the TYPE and MODE fields. This will enable auto detection of your IDE hard disk during bootup. This will allow you to change your hard disks (with the power off) and then power on without having to reconfigure your hard disk type. If you use older hard disks that do not support this feature, then you must configure the hard disk in the standard method as described earlier by the “User” option.

NOTE: After the IDE hard disk drive information has been entered into BIOS, new IDE hard disk drives must be partitioned (such as with FDISK) and then formatted before data can be read from and write on. Primary IDE hard disk drives must have its partition set to *active* (also possible with FDISK).

NOTE: SETUP Defaults are noted in parenthesis next to each function heading.

Drive A / Drive B (None)

These fields record the types of floppy disk drives installed in your system. The available options for drives A and B are: *360KB, 5.25 in.; 1.2MB, 5.25 in.; 720KB, 3.5 in.; 1.44MB, 3.5 in.; 2.88MB, 3.5 in.; None*

To enter the configuration value for a particular drive, highlight its corresponding field and then select the drive type using the left- or right-arrow keys.

Floppy 3 Mode Support (Disabled)

This is the Japanese standard floppy drive. The standard stores 1.2MB in a 3.5inch diskette. This is normally disabled but you may choose from either: *Drive A, Drive B, Both, and Disabled*

Video (EGA/VGA)

Set this field to the type of video display card installed in your system. The options are *EGA/VGA, CGA 49, CGA 80, and Mono* (for Hercules or MDA).

If you are using a VGA or any higher resolution card, choose *EGA/VGA*.

Halt On (All Errors)

This field determines which types of errors will cause the system to halt. Choose from *All Errors; No Errors; All,But Keyboard, All,But Diskette; and All,But Disk/Key*.

IV. BIOS SOFTWARE

BIOS Features Setup

This “BIOS Features Setup” option consists of configuration entries that allow you to improve your system performance, or let you set up some system features according to your preference. Some entries are required by the motherboard’s design to remain in their default settings.



A section at the lower right of the screen displays the control keys you can use. Take note of these keys and their respective uses. If you need information on a particular entry, highlight it and then press <F1>. A pop-up help menu will appear to provide you with the information you need. <F5> loads the last set values, <F6> and <F7> loads the BIOS default values and Setup default values, respectively.

NOTE: SETUP Defaults are noted in parenthesis next to each function heading.

Details of BIOS Features Setup

CPU Internal Core Speed

Select your CPU speed in this field or select *Manual* for customized selections of the “CPU Core:Bus Freq. Multiple: XXx” (2.0x-8.0x with increments of 0.5) and the “CPU Bus Frequency: XX” (50, 60, 66, 68, 75, 83). If you set the CPU speed in excess of the CPU specifications, your computer may not boot up next time. Remove and reinstall the CPU in order to reset the speed to the last successful bootup speed.

Boot Virus Detection (Enabled)

This field allows you to set boot virus detection, ensuring a virus-free boot sector. This new antivirus solution is unlike native BIOS tools, which offer limited virus protection typically by write-protecting the partition table, because it guards against boot virus threats earlier in the boot cycle, that is, before they have a chance to load into your system, ensuring your computer boots to a clean operating system. The system halts and displays a warning message when it detects a virus. If this occurs, you can either allow the operation to continue or use a bootable virus-free floppy disk to restart and investigate your system. Because of conflicts with new operating systems, for example, during installation of new softwares, you may have to set this to *Disabled* to prevent write errors.

IV. BIOS SOFTWARE

CPU Level 1 Cache / CPU Level 2 Cache (Enabled)

These fields allow you to choose from the default of *Enabled* or choose *Disabled* to turn on or off the CPU's Level 1 and Level 2 built-in cache.

CPU Level 2 Cache ECC Check (Disabled)

Enabled allows the system to run an ECC check on the Level 2 cache. This is *Disabled* because this feature slows performance.

BIOS Update (Enabled)

This functions as an update loader integrated into the BIOS to supply the processor with the required data. The BIOS will load the update on all processors during system bootup in the default position of *Enabled*.

Quick Power On Self Test (Enabled)

This field speeds up the Power-On Self Test (POST) routine by skipping retesting a second, third, and fourth time. Setup default setting for this field is *Enabled*. A complete test of the system is done on each test.

HDD Sequence SCSI/IDE First (IDE)

When using both SCSI and IDE hard disk drives, IDE is always the boot disk using drive letter C (default setting of *IDE*). This new feature allows a SCSI hard disk drive to be the boot disk when set to *SCSI*. This allows multiple operating systems to be used on both IDE and SCSI drives or the primary operating system to boot using a SCSI hard disk drive.

Boot Sequence (A,C)

This field determines where the system looks first for an operating system. Options are *C,A; A,CDROM,C; CDROM,C,A; D,A; E,A; F,A; C only; LS/ZIP, C;* and *A,C*. The setup default setting is to check first the floppy diskette and then the hard disk drive.

Boot Up Floppy Seek (Disabled)

When enabled, the BIOS will seek drive A once.

Floppy Disk Access Control (R/W)

This allows protection of files from the computer system to be copied to floppy disks by allowing the setting of *Read Only* to only allow reads from the floppy disk drive but not writes. The setup default *R/W* allows both reads and writes.

IDE HDD Block Mode Sectors (HDD MAX)

This field enhances hard disk performance by making multi-sector transfers instead of one sector per transfer. Most IDE drives, except older versions, can utilize this feature. Selections are *HDD MAX, Disabled, 2, 4, 8, 16,* and *32*.

IV. BIOS SOFTWARE

Security Option (System)

When you specify a *Supervisor Password* and/or *User Password* (explained later in this section), the Security Option field determines when the system prompts for the password. The default setting is **System**, where the system prompts for the User Password every time you start your system. The other option is *Setup*, where the system goes through its startup routine unless the Setup utility is called, when the system prompts for the Supervisor Password.

PS/2 Mouse Function Control (Auto)

The default of *Auto* allows the system to detect a PS/2 mouse on bootup. If detected, IRQ12 will be used for the PS/2 mouse. IRQ12 will be reserved for expansion cards if a PS/2 mouse is not detected. *Enabled* will always reserve IRQ12, whether on bootup a PS/2 mouse is detected or not.

PCI/VGA Palette Snoop (Disabled)

Some display cards that are nonstandard VGA such as graphics accelerators or MPEG Video Cards may not show colors properly. The setting *Enabled* should correct this problem. Otherwise leave this on the setup default setting of *Disabled*.

OS/2 Onboard Memory > 64M (Disabled)

When using OS/2 operating systems with installed DRAM of greater than 64MB, you need to set this option to *Enabled* otherwise leave this on *Disabled*.

.....

Video ROM BIOS Shadow (Enabled)

This field allows you to change the video BIOS location from ROM to RAM. Relocating to RAM enhances system performance, as information access is faster than the ROM.

C8000-CBFFF to DC000-DFFFF (Disabled)

These fields are used for shadowing other expansion card ROMs. If you install other expansion cards with ROMs on them, you will need to know which addresses the ROMs use to shadow them specifically. Shadowing a ROM reduces the memory available between 640K and 1024K by the amount used for this purpose.

Boot Up NumLock Status (On)

This field enables users to activate the Number Lock function upon system boot.

Typematic Rate Setting (Disabled)

When enabled, you can set the two typematic controls listed next. Setup default setting is *Disabled*.

Typematic Rate (Chars/Sec) (6)

This field controls the speed at which the system registers repeated keystrokes. Options range from 6 to 30 characters per second. Setup default setting is **6**; other settings are 8, 10, 12, 15, 20, 24, and 30.

Typematic Delay (Msec) (250)

This field sets the time interval for displaying the first and second characters. Four delay rate options are available: 250, 500, 750, and 1000.

IV. BIOS SOFTWARE

Chipset Features Setup

This “Chipset Features Setup” option controls the configuration of the board’s chipset. Control keys for this screen are the same as for the previous screen.



NOTE: SETUP Defaults are noted in parenthesis next to each function heading.

Details of Chipset Features Setup

EDO Auto Configuration (60ns DRAM)

The default setting of *60ns DRAM* sets the optimal timings for items 2 through 5 for 60ns DRAM modules. If you are using 70ns DRAM modules, you must change this item to *70ns DRAM*. See section III for DRAM installation information.

SDRAM Configuration (12ns SDRAM)

If your DIMM modules are all 10ns SDRAM, you may set this to 10ns SDRAM.

SDRAM RAS to CAS Delay (Auto)

Leave on default setting.

SDRAM RAS Precharge Time (Auto)

Leave on default setting.

MA Wait State (Auto)

Leave on default setting.

SDRAM Banks Close Policy (Arbitration)

Leave on default setting.

16-bit I/O Recovery Time (1 BUSCLK)

Timing for 16-bit ISA cards. Leave on default setting.

8-bit I/O Recovery Time (1 BUSCLK)

Timing for 8-bit ISA cards. Leave on default setting.

Graphics Aperture Size (64MB)

Memory-mapped, graphics data structures can reside in a Graphics Aperture. Leave on default setting.

IV. BIOS SOFTWARE

Video Memory Cache Mode (UC)

USWC (uncacheable, speculative write combining) is a new cache technology for the video memory of the processor. It can greatly improve the display speed by caching the display data. You must leave this on the default setting of *UC* (uncacheable) if your display card cannot support this feature or else your system may not boot.

PCI 2.1 Support (Enabled)

This function allows you to *Enable* or *Disable* PCI 2.1 features. Leave on *Enabled* setting for PCI 2.1 compliancy.

Memory Hole At 15M–16M (Disabled)

Enabling this feature reserves 15MB to 16MB memory address space to ISA expansion cards that specifically require this setting. This makes the memory from 15MB and up unavailable to the system. Expansion cards can only access memory up to 16MB. The default is *Disabled*.

.....

Onboard FDC Controller (Enabled)

When *Enabled*, this field allows you to connect your floppy disk drives to the onboard floppy disk drive connector instead of a separate controller card. If you want to use a different controller card to connect the floppy disk drives, set this field to *Disabled*.

Onboard FDC Swap A & B (No Swap)

This field allows you to reverse the hardware drive letter assignments of your floppy disk drives. Two options are available: *No Swap* and *Swap AB*. If you want to switch drive letter assignments through the onboard chipset, set this field to *Swap AB*.

Onboard Serial Port 1 (3F8H/IRQ4)

Settings are *3F8H/IRQ4*, *2F8H/IRQ3*, *3E8H/IRQ4*, *2E8H/IRQ10*, and *Disabled* for the onboard serial connector.

Onboard Serial Port 2 (2F8H/IRQ3)

Settings are *3F8H/IRQ4*, *2F8H/IRQ3*, *3E8H/IRQ4*, *2E8H/IRQ10*, and *Disabled* for the onboard serial connector.

Onboard Parallel Port (378H/IRQ7)

This field sets the address of the onboard parallel port connector. You can select either: *3BCH/IRQ7*, *378H/IRQ7*, *278H/IRQ5*, *Disabled*. If you install an I/O card with a parallel port, ensure that there is no conflict in the address assignments. The PC can support up to three parallel ports as long as there are no conflicts for each port.

IV. BIOS SOFTWARE

Parallel Port Mode (ECP+EPP)

This field allows you to set the operation mode of the parallel port. The setting *Normal*, allows normal-speed operation but in one direction only; *EPP* allows bidirectional parallel port operation at maximum speed; *ECP* allows the parallel port to operate in bidirectional mode and at a speed faster than the maximum data transfer rate; *ECP+EPP* allows normal speed operation in a two-way mode.

ECP DMA Select (3)

This selection is available only if you select *ECP* or *ECP+EPP* in the **Parallel Port Mode**. Select either DMA Channel *1*, *3*, or *Disable*.

UART2 Use Infrared (Disabled)

When enabled, this field activates the onboard infrared feature and sets the second serial UART to support the infrared module connector on the motherboard. If your system already has a second serial port connected to the onboard COM2 connector, it will no longer work if you enable the infrared feature. By default, this field is set to *Disabled*, which leaves the second serial port UART to support the COM2 serial port connector. See **IrDA-compliant infrared module connector** under section III.

Onboard PCI IDE Enable (Both)

You can select to enable the *primary* IDE channel, *secondary* IDE channel, *both*, or *disable* both channels (for systems with only SCSI drives).

IDE Ultra DMA Mode (Auto)

Leave this on *Auto* or set to *Disable* to turn off IDE Ultra DMA Mode.

IDE 0 Master/Slave PIO/DMA Mode, IDE 1 Master/Slave PIO/DMA Mode (Auto)

Each channel (0 & 1) has both a master and a slave making four IDE devices possible. Because each IDE device may have a different PIO Mode timing of *0*, *1*, *2*, *3*, or *4*, it is necessary for these to be independent. DMA Mode timing allows *0*, *1*, or *2*. The default setting of *Auto* will allow auto-detection to ensure optimal performance.

IV. BIOS SOFTWARE

Power Management Setup

This “Power Management Setup” option allows you to reduce power consumption. This feature turns off the video display and shuts down the hard disk after a period of inactivity.



NOTE: SETUP Defaults are noted in parenthesis next to each function heading.

Details of Power Management Setup

Power Management (User Define)

This field acts as the master control for the power management modes. *Max Saving* puts the system into power saving mode after a brief period of system inactivity; *Min Saving* is almost the same as *Max Saving* except that this time the system inactivity period is longer; *Disable* disables the power saving features; *User Define* allows you to set power saving options according to your preference.

IMPORTANT: Advanced Power Management (APM) should be installed to keep the system time updated when the computer enters suspend mode activated by the BIOS Power Management. For DOS environments, you need to add the statement, `DEVICE=C:\DOS\POWER.EXE`, in your `CONFIG.SYS`. For Windows 3.x and Windows 95, you need to install Windows with the APM feature. A battery and power cord icon labeled “Power” will appear in the “Control Panel.” Choose “Advanced” in the Power Management Field.

Video Off Option (Always On)

This field determines when to activate the video off feature for monitor power management. The settings are *All Modes -> Off*; *Always On*; *Suspend -> Off*; and *Susp,Stby -> Off*.

IV. BIOS SOFTWARE

Video Off Method (Blank Screen)

This field defines the video off features. The following options are available: *DPMS OFF*, *DPMS Reduce ON*, *Blank Screen*, *V/H SYNC+Blank*, *DPMS Standby*, and *DPMS Suspend*. The DPMS (Display Power Management System) features allow the BIOS to control the video display card if it supports the DPMS feature. *Blank Screen* only blanks the screen (use this for monitors without power management or “green” features. If set up in your system, your screen saver will not display with *Blank Screen* selected). *V/H SYNC+Blank* blanks the screen and turns off vertical and horizontal scanning.

.....

PM Timers

This section controls the time-out settings for the Power Management scheme. The fields included in this section are “HDD Power Down”, which places the hard disk into its lowest power consumption mode, and the Doze, Standby and Suspend system inactivation modes.

The system automatically “wakes up” from any power saving mode when there is system activity such as when a key is pressed from the keyboard, or when there is activity detected from the enabled IRQ channels.

HDD Power Down (Disable)

Shuts down any IDE hard disk drives in the system after a period of inactivity. This time period is user-configurable to *1–15 Min* or *Disable*. This feature does not affect SCSI hard drives.

Suspend Mode (Disable)

Sets the period of time after which each of these modes activate: *1 Min*, *2 Min*, *4 Min*, *8 Min*, *10 Min*, *20 Min*, *30 Min*, *1 Hour*, *2 Hour*, and *4 Hour*.

.....

Power Up Control

This section determines the ways the system can be controlled when it is started or restarted, when modem activity is detected, or when power to the computer is interrupted and reapplied. The Soft-Off mode refers to powering off the system through a momentary button switch (ATX switch) or through the software as opposed to disconnecting the AC power by way of a rocker switch or other means.

PWR Button < 4 Secs (Soft Off)

When set to *Soft Off*, the ATX switch can be used as a normal system power-off button when pressed for less than 4 seconds. *Suspend* allows the button to have a dual function where pressing less than 4 seconds will place the system in sleep mode. *No Function* disables the ATX switch function when the button is pressed under 4 seconds. Regardless of the setting, holding the ATX switch for more than 4 seconds will power off the system.

IV. BIOS SOFTWARE

PWR Up On Modem Act (Enabled)

This allows either settings of *Enabled* or *Disabled* for powering up the computer (turns the ATX power supply on) when the modem receives a call while the computer is off. NOTE: The computer cannot receive or transmit data until the computer and applications are fully running, thus connection cannot be made on the first try. Turning an external modem off and then back on while the computer is off causes an initialization string that will also cause the system to power on.

AC PWR Loss Restart (Disabled)

This allows you to set whether you want your system to boot up after the power has been interrupted. *Disabled* leaves your system off after reapplying power and *Enabled* boots up your system after reapplying power.

Wake on LAN (Enable)

Enable allows the ASUS PCI-L101 fast Ethernet card to wake up the system using the proper software. *Disable* turns off this feature.

Automatic Power Up (Disabled)

This allows you to have an unattended or automatic power up of your system. You may configure your system to power up at a certain time of the day by selecting *Everyday*, which will allow you to set the time or at a certain time and day by selecting *By Date*.

.....

Fan Monitor (xxxxRPM)

The onboard hardware monitor is able to detect the Chassis Fan Speed, CPU Fan Speed, and the Power Supply Fan Speed in Rotations Per Minute (RPM). The Power Supply Fan Speed is set to *Ignore* because many systems do not have this type of connection. These values refresh upon any key entries in the BIOS setup screen. Set to *Ignore* if one of these are not used so that error messages will not be given.

.....

Thermal Monitor (xxxC/xxxF)

The onboard hardware monitor is able to detect the CPU and MB (motherboard) temperatures. These values refresh upon key entries. Set to *Ignore* only if necessary.

.....

Voltage Monitor (xx.xV)

The onboard hardware monitor is able to detect the voltages put out by the voltage regulators. These values refresh upon key entries. Set to *Ignore* only if necessary.

NOTE: If any of the monitored items are out of range, an error message will appear: "Hardware Monitor found an error, enter POWER MANAGEMENT SETUP for details". You will then be prompted to "Press **F1** to continue, **DEL** to enter SETUP".

IV. BIOS SOFTWARE

PNP and PCI Setup

This “PNP and PCI Setup” option configures the PCI bus slots. All PCI bus slots on the system use INTA#, thus all installed PCI cards must be set to this value.



NOTE: SETUP Defaults are noted in parenthesis next to each function heading.

Details of PNP and PCI Setup

PNP OS Installed (No)

This field allows you to use a Plug-and-Play (PnP) operating system to configure the PCI bus slots instead of using the BIOS. Thus interrupts may be reassigned by the OS when *Yes* is selected. When a non-PnP OS is installed or to prevent reassigning of interrupt settings, select the default setting of *No*.

Slot 1 (RIGHT) IRQ to Slot 3 IRQ (Auto)

These fields set how IRQ use is determined for each PCI slot. The default setting for each field is *Auto*, which uses auto-routing to determine IRQ use. The other options are manual settings of *NA*, *5*, *7*, *9*, *10*, *11*, *12*, *14* or *15* for each slot.

PCI Latency Timer (32 PCI Clock)

The default setting of *32 PCI Clock* enables maximum PCI performance for this motherboard.

IRQ xx Used By ISA (No/ICU)

These fields indicate whether or not the displayed IRQ for each field is being used by a legacy (non-PnP) ISA card. Two options are available: *No/ICU* and *Yes*. The first option, the default value, indicates either that the displayed IRQ is not used or an ISA Configuration Utility (ICU) is being used to determine if an ISA card is using that IRQ. If you install a legacy ISA card that requires a unique IRQ, and you are not using an ICU, you must set the field for that IRQ to *Yes*. For example: If you install a legacy ISA card that requires IRQ 10, then set **IRQ10 Used By ISA** to *Yes*.

.....

IV. BIOS SOFTWARE

DMA x Used By ISA (No/ICU)

These fields indicate whether or not the displayed DMA channel for each field is being used by a legacy (non-PnP) ISA card. Available options include: *No/ICU* and *Yes*. The first option, the default setting, indicates either that the displayed DMA channel is not used or an ICU is being used to determine if an ISA card is using that channel. If you install a legacy ISA card that requires a unique DMA channel, and you are not using an ICU, you must set the field for that channel to *Yes*.

ISA MEM Block BASE (No/ICU)

This field allows you to set the base address and block size of a legacy ISA card that uses any memory segment within the C800H and DFFFH address range. If you have such a card, and you are not using an ICU to specify its address range, select a base address from the six available options; the **ISA MEM Block SIZE** field will then appear for selecting the block size. If you have more than one legacy ISA card in your system that requires to use this address range, you can increase the block size to either 8K, 16K, 36K, or 64K. If you are using an ICU to accomplish this task, leave **ISA MEM Block BASE** to its default setting of *No/ICU*.

Symbios SCSI BIOS (Auto)

Auto allows the BIOS to detect whether you have a Symbios SCSI card, if detected the onboard Symbios BIOS will be enabled, if not then it will be disabled. *Disabled* prevents the onboard Symbios BIOS to be enabled so that the external Symbios SCSI card's own BIOS can be used instead. **Note:** If your Symbios SCSI card does not have a BIOS the Symbios SCSI card will not function.

USB IRQ (Enabled)

Enabled reserves an IRQ# for the USB to work, *Disabled* does not allow the USB to have an IRQ# and therefore prevents the USB from functioning. If you do not use USB devices, you may *Disable* this feature to save an extra IRQ# for expansion cards.

TV Standard Select (NTSC)

This allows you to select the video standard for your country. Select either *NTSC* or *PAL* if using the TV-Out feature on this motherboard.

ONB VGA BIOS First (No)

This allows you to select whether you want to use the onboard VGA BIOS as the primary BIOS. *No* allows external VGA cards to take precedent when detected. *Yes* always uses the onboard VGA card's BIOS, even when an external VGA card is installed.

IV. BIOS SOFTWARE

Load BIOS Defaults

This “Load BIOS Defaults” option allows you to load the troubleshooting default values permanently stored in the BIOS ROM. These default settings are non-optimal and disable all high performance features. To load these default settings, highlight “Load BIOS Defaults” on the main screen and then press <Enter>. The system displays a confirmation message on the screen. Press <Y> and then <Enter> to confirm. Press <N> and then <Enter> to abort. This feature does not affect the fields on the Standard CMOS Setup screen.

Load Setup Defaults

This “Load Setup Defaults” option allows you to load the default values to the system configuration fields. These default values are the optimized configuration settings for the system. To load these default values, highlight “Load Setup Defaults” on the main screen and then press <Enter>. The system displays a confirmation message on the screen. Press <Y> and then <Enter> to confirm. Press <N> and then <Enter> to abort. This feature does not affect the fields on the Standard CMOS Setup screen.

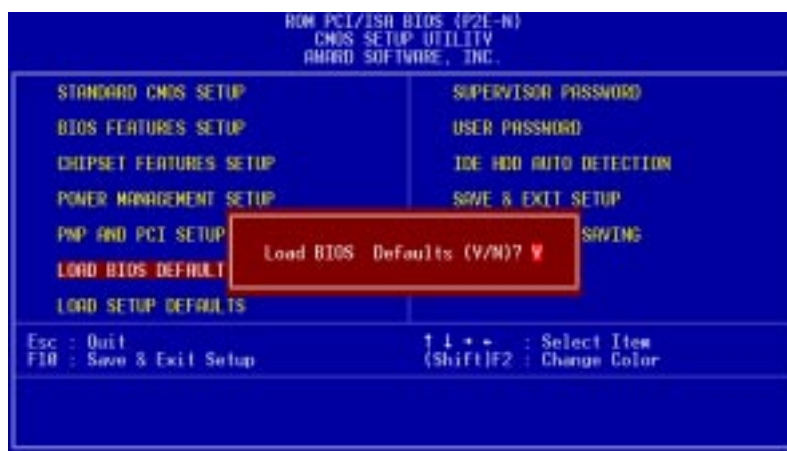

IV. BIOS SOFTWARE

Supervisor Password and User Password

These two options set the system passwords. “Supervisor Password” sets a password that will be used to protect the system and the Setup utility; “User Password” sets a password that will be used exclusively on the system. By default, the system comes without any passwords. To specify a password, highlight the type you want and then press <Enter>. A password prompt appears on the screen. Taking note that the password is case sensitive, and can be up to 8 alphanumeric characters long, type in your password and then press <Enter>. The system confirms your password by asking you to type it again. After setting a password, the screen automatically reverts to the main screen.



To implement password protection, specify in the “Security Option” field of the BIOS Features Setup screen when the system will prompt for the password. If you want to disable either password, press <Enter> instead of entering a new password when the “Enter Password” prompt appears. A message confirms the password has been disabled.

NOTE: If you forget the password, see CMOS RAM in section III for procedures on clearing the CMOS.

IV. BIOS SOFTWARE

IDE HDD Auto Detection

This “IDE HDD Auto Detection” option detects the parameters of an IDE hard disk drive, and automatically enters them into the Standard CMOS Setup screen.

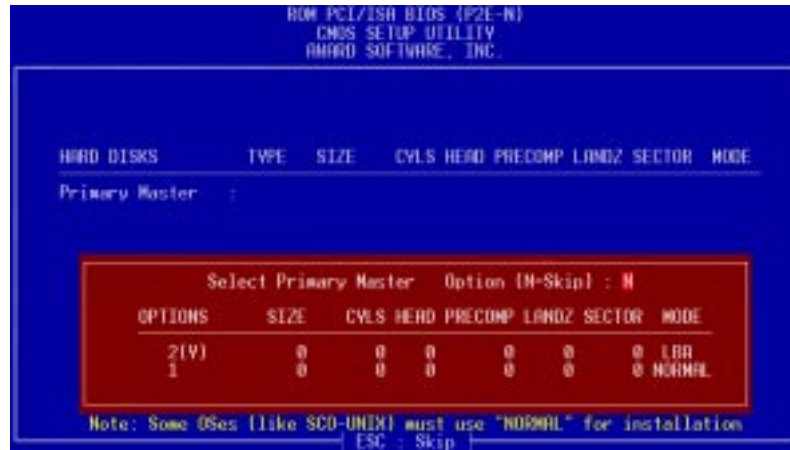

Up to four IDE drives can be detected, with parameters for each listed inside the box. To accept the optimal entries, press <Y> or else select from the numbers displayed under the OPTIONS field (2, 1, 3 in this case); to skip to the next drive, press <N>. If you accept the values, the parameters will appear listed beside the drive letter on the screen. The process then proceeds to the next drive letter. Pressing <N> to skip rather than to accept a set of parameters causes the program to enter zeros after that drive letter.

Remember that if you are using another IDE controller that does not feature Enhanced IDE support for four devices, you can only install two IDE hard disk drives. Your IDE controller must support the Enhanced IDE features in order to use Drive E and Drive F. The onboard PCI IDE controller supports Enhanced IDE, with two connectors for connecting up to four IDE devices. If you want to use another controller that supports four drives, you must disable the onboard IDE controller in the Chipset Features Setup screen.

When auto-detection is completed, the program automatically enters all entries you accepted on the field for that drive in the Standard CMOS Setup screen. Skipped entries are ignored and are not entered in the screen.

If you are auto-detecting a hard disk that supports the LBA mode, three lines will appear in the parameter box. Choose the line that lists LBA for an LBA drive. Do not select Large or Normal.

The auto-detection feature can only detect one set of parameters for a particular IDE hard drive. Some IDE drives can use more than one set. This is not a problem if the drive is new and empty.

IV. BIOS SOFTWARE

IMPORTANT: If your hard disk was already formatted on an older previous system, incorrect parameters may be detected. You will need to enter the correct parameters manually or use low-level format if you do not need the data stored on the hard disk.

If the parameters listed differ from the ones used when the disk was formatted, the disk will not be readable. If the auto-detected parameters do not match the ones that should be used for your disk, do not accept them. Press <N> to reject the presented settings and enter the correct ones manually from the Standard CMOS Setup screen.

Save & Exit Setup

Select this option to save into the CMOS memory all modifications you specified during the current session. To save the configuration changes, highlight the “Save & Exit Setup” option on the main screen, type “Y”, and then press <Enter>.



Exit Without Saving

Select this option to exit the Setup utility without saving the modifications you specify during the current session. To exit without saving, highlight the “Exit Without Saving” option on the main screen and then press <Enter>.

V. Support CD

Support CD Main Menu

Insert your CD or double click on your CD drive icon in “My Computer” to bring up the autorun menu or run **Setup.exe** in the root directory of the ASUS Support CD.

NOTE: The support CD version and contents are constantly updated without notice.

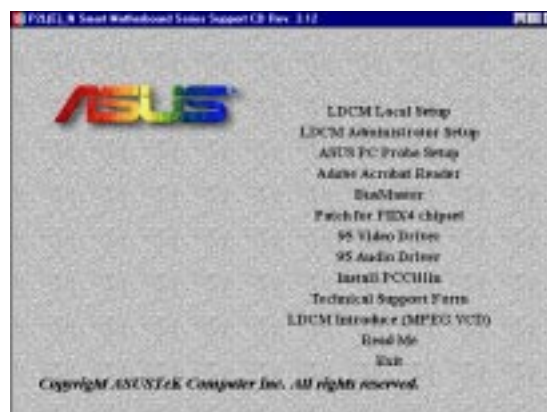

Main Menu Selections

LDCM Local Setup: Installs the LANDesk Client Manager software to monitor the local system. Please view the user’s manual in Adobe Acrobat PDF format located in the “LDCM” directory on the ASUS Support CD.

LDCM Administrator Setup: Installs the LANDesk Client Manager software to monitor PC systems on the network within the same bridge address with the Local software installed. Please view the user’s manual in Adobe Acrobat PDF format located in the “LDCM” directory on the ASUS Support CD.

ASUS PC Probe Setup: Installs a simple utility to monitor your computer’s fan, temperature, and voltages. (**NOTE:** Will not run with LDCM installed.) Please view the user’s manual in Adobe Acrobat PDF format located in the “ASUSLM” directory on the ASUS Support CD or see PC Probe section in this user’s manual.

Adobe Acrobat Reader: Installs the Adobe Acrobat Reader software necessary to view the user’s manuals in Adobe Acrobat PDF format.

BusMaster: Installs the Intel BusMaster IDE drivers for improved performance.

Patch for PIIX4 chipset: Installs the necessary drivers for PCI card and PCI bridge for Windows 95/95a (OSR1) and 95b (OSR2) for ASUS motherboards.

95 Video Driver: Video driver and utilities installation menu. Please see the video section in this user’s manual.

95 Audio Driver: Audio driver and utilities installation menu. Please see the audio section in this user’s manual.

Install PCCillin: Installs “PC-cillin” virus protection software. Please view the online help if you have any questions.

Technical Support Form: View the ASUS Technical Support Form.

LDCM Introduction (MPEG): View a video on the LDCM features.

Read Me: View additional notes concerning this product.

Exit: Exit the current menu.

A. PC Probe Utility

ASUS® PC Probe



USER'S MANUAL

Included only with products using hardware monitoring components.

A. PC Probe Utility

Installing and Running ASUS PC Probe

The ASUS PC Probe is a convenient utility to monitor the computer system's vital components: fan rotations, voltages, and temperatures.

NOTE: In order for the ASUS PC Probe to run, Intel's LDCM utility cannot be installed.

1. Click on "ASUS PC Probe Setup" from the main menu.
2. Click "OK" after reading the welcome message.
3. Click the install button.
4. Make any desired setting changes.
5. Click "OK" when the installation is completed. PC Probe will run automatically.

When ASUS PC Probe starts, a splash screen appears allowing you to "Show Monitor" or "Close." You can select whether you want the splash screen to show in the future.

Click "ASUS PC Probe" from the "Start" button to run the utility if you exit the utility or did not check "Run when Windows Starts."

A "doctor" will appear on the task bar indicating that ASUS PC Probe is running. Left clicking the "doctor" will allow you to see your PC status.

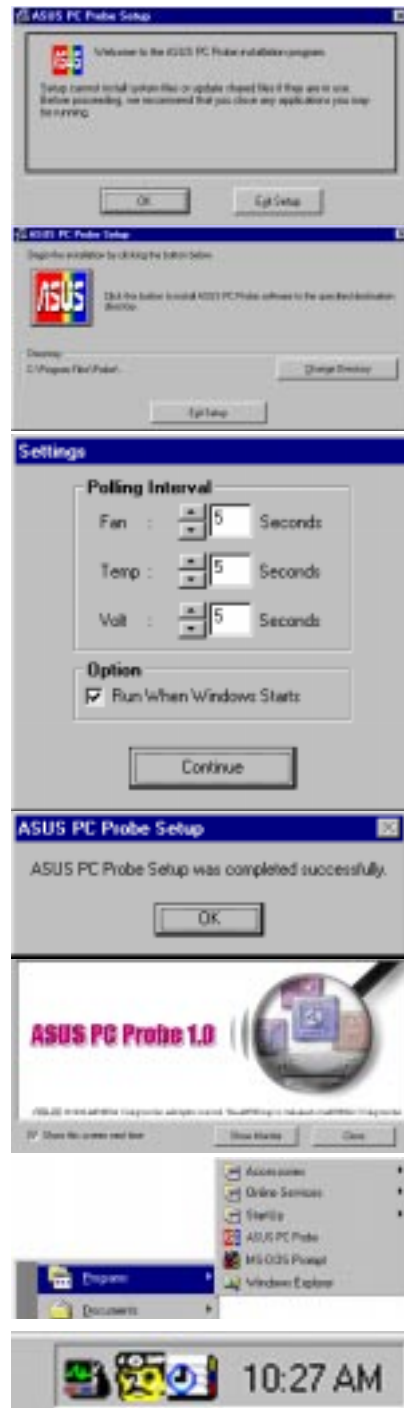

A. PC Probe Utility

Uninstalling Programs

Uninstalling programs is a basic component within Windows 95. You may use this function if individual programs does not provide their own uninstallation methods.

1. If other hardware monitoring programs such as the Intel LDCM are installed, the ASUS PC Probe will not run.
2. Uninstall other hardware monitoring programs if you want to use the ASUS PC Probe by running “Add/Remove Programs” from the Control Panel.
3. Select the program you wish to remove and click the **Add/Remove...**

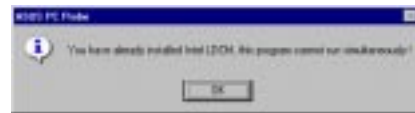

The ASUS PC Probe can also be removed by the same method.



A. PC Probe Utility

Using the ASUS PC Probe

Fan Rotation Status

- Analog view of PC's fan rotation
- Digital view of PC's fan rotation
- PC's Fan warning threshold adjustment



PC Temperature Status

- Temperature Warning threshold adjustment
- Analog view of PC's temperature
- Digital view of PC's temperature
- Digital view of PC's temperature warning threshold



PC Voltage Status

- Upper warning threshold adjustment
- Analog view of PC's voltages
- Lower warning threshold adjustment
- Digital view of PC's voltages
- Digital view of PC's voltage warning thresholds



PC Status Summary

- PC's Fan Rotations per minute
- PC's Temperature °C/°F
- PC's Voltages



A. PC Probe Utility

PC Probe Settings

Change PC Probe refresh times here

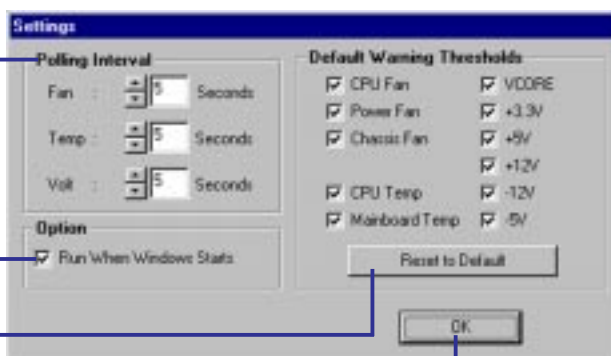

Check here to start PC Probe each time you enter Windows.

Check the items above you wish to reset to its default values and click this button.

Click here to exit the settings screen.

Right clicking the “doctor” will bring up a menu to turn ASUS PC Probe on, off, or exit the utility.



The “doctor” appears gray when off.



When there is a problem, the “doctor’s” light flashes red, the PC speaker sounds, and ASUS PC Probe monitor is displayed.



(This page was intentionally left blank)

B. Video Driver

B. Video Driver	65
First Time Installation	65
Install Windows 95 Display Driver	66
Install DirectX.....	67
Install Video Player	67
Display Settings for Windows 95	68
Video Driver Installation for Windows 3.x	69
Software MPEG & Video Player for Windows 3.x	71
ATI Desktop Control Panel	73
ATI Desktop Features	73
FlexDesk+	74
FlexDesk+ Basic Settings	74
FlexDesk+ Advanced Settings	76
DPMS (for Windows)	77
Timer Settings	77
Buttons	77
DeskScape	78
DeskScape Functions	78
Buttons	79
WinSwitch.....	79
Screen Adjustment	80
DPMS Parameters	82
B. Other Video Drivers	83
Video Driver Installation for Windows NT 4.0	83
Video Driver Installation for Windows NT 4.0	85
Video Driver Installation for IBM OS/2	87
AutoCAD Video Driver Installation	88
Microstation Video Driver Installation	89
Select System Information (optional)	90
Quick Setup (optional)	90
VDIF Files (optional).....	91
Advanced Setup (optional)	92
Diagnostics.....	92
Troubleshooting	93
System Lockup	93

B. Video Driver

Troubleshooting	93
Windows 95 mach64 enhanced display driver	95
Windows 95 property page problems	95
ATI Video Player Notes	95
Other Problems & Actions	96
C. Video Player	97
Windows Video Player	97
Features	97
Playing Audio CDs (Only in window 95)	98
Playing Media Files	99
Playing Interactive Discs (Video CD 2.0)	99

B. Video Driver

First Time Installation

When starting Windows 95 (OSR2.0) or Windows NT 4.0, the operating system will detect that you have a new PCI Multimedia Device, then an **Update Device Driver Wizard** will appear.

Click the **Next** button.

Click **Other Locations** button to direct the wizard to the audio driver files.

Click the **Browse** button to locate the “\DRIVERS\ATI435\WIN95” (or NT40) directory on the ASUS Support CD.

Click the **Ok** button and “RAGE PRO TURBO 2X (English) (DirectX)” will be shown. Click the **Finish** button.

Click **No** when asked if you want to keep files during version conflicts.

You will be prompted to locate disk #1 of the drivers. Click **Ok** button and then click the **Browse** button and locate the “\DRIVERS\ATI435\WIN95” (or NT40) directory on the ASUS Support CD.

You will be prompted to locate disk #2 of the drivers. Click **Ok** button and then click the **Browse** button and locate the “\DRIVERS\ATI435\WIN95” (or NT40) directory on the ASUS Support CD again.



B. Video Driver

Install Windows 95 Display Driver

Install Windows 95 Display Driver allows your onboard VGA to function properly.

Reinsert your CD or double click on your CD drive icon in My Computer to bring up the autorun screen or run Setup.exe in the root directory of the CD. Click 95 Video Driver from the main menu.

Click **Install Windows 95 Display Driver** to begin the installation wizard.

The “ATI 3D” setup screen will appear.

Click **Next** to complete your installation.

Click **Yes** to restart your computer.

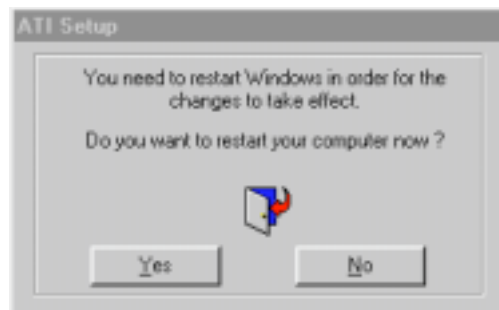

B. Video Driver

Install DirectX

Microsoft DirectX allows Direct3D support in Windows.

Reinsert your CD or double click on your CD drive icon in My Computer to bring up the autorun screen or run Setup.exe in the root directory of the CD. Click 95 Video Driver from the main menu.

Click **Install DirectX5** to begin installation.

Warning: Your computer will automatically restart without warning.



Install Video Player

Video Player allows the viewing of the following video files identified by their extensions:

- MPEG Format: (*.MPG, *.DAT, *.MPV) Extensions
- AVI Files (*.AVI) Extensions

For Software MPEG support in Windows 95, you must first install “DirectVideo Upgrade” For Microsoft Windows, then install Video Player. DirectVideo is automatically installed along with “Install DirectX.”

Click **Install Video Player** to begin installation.

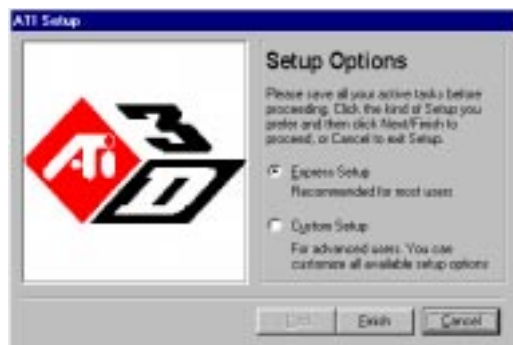

Use **Express Setup** and click **Next** to complete your installation.

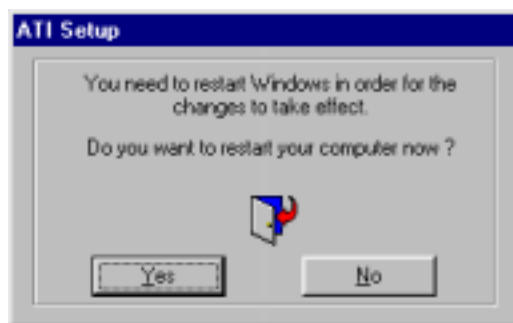

Click **Yes** to restart your computer.

B. Video Driver

Display Settings for Windows 95

Changing display settings:

To enter the “Display Properties” at any time, right click your mouse on the desktop and select “Properties” or double click the “Display” icon in the “Control Panel.” Click the appropriate Tab as follows:

Adjustment: Click on the Position or Size arrows to make your screen appear as centered and large as possible.



Panning: This allows you to assign hotkeys in the "Value" box to move your screen up, down, left, right, in, or out in any application. Click on "Defaults" button to fill in the "Value" box with default values.



Color: This allows you to adjust the Gamma level for your monitor and color levels for Red, Green, and Blue. You can save your settings by clicking "Save As" button and typing in a file name. This allows you to recall previously saved settings. Click on "Defaults" button to restore all settings to the default.



Settings: This allows you to adjust the Color palette, Font size, and Display area. Choose “Center dialog boxes” to keep messages visible, “Enable task bar icon” for easy access to the ATI configuration menus, and “Show settings icon on task bar” for quick resolution changes.



B. Video Driver

Video Driver Installation for Windows 3.x

For your convenience, the ATI video drivers for Windows 3.x can be installed in Windows 3.x or in DOS. The autorun ASUS Windows 3.1 Install Shell cannot be automatically run by Window 3.x, so manual execution is necessary.

Installing ATI video drivers in Windows 3.x:

1. Start Windows 3.x
2. Run **File Manager**
3. Insert the ASUS installation CD.
4. Change to your CD drive.
5. Double click **setup.exe** - ASUS Windows 3.1 Install Shell appears

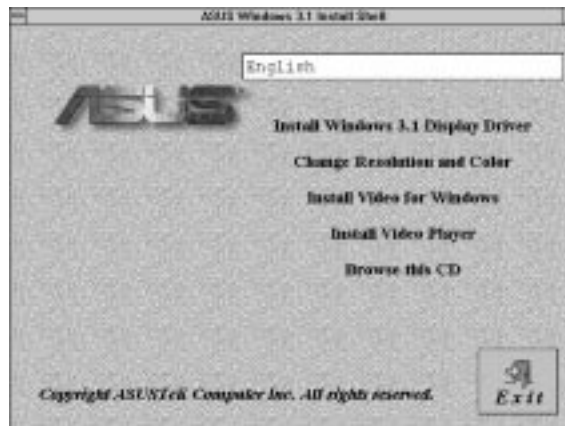

6. Click on **Install Windows 3.1 Display Driver**- Confirm Installation appears
7. Click **Yes** - Copying Files appears - Restart Windows appears
8. Click **Restart now** to complete installation - ATI Desktop group and icon will appear upon restart - Install Shell Message appears:

Now installation process will continue. If you want to install Video for Windows, please keep your ASUS driver CD in CD-ROM drive.

9. Click **OK** - Follow the instructions for Software MPEG & Video Player.

B. Video Driver

Video Driver Installation for Windows 3.x

Installing ATI video drivers in DOS:

1. Enter DOS mode (Exit Windows, do not use Windows DOS prompt)
2. Change to your CD-ROM drive
3. Type: **SETUP** (assuming your CD-ROM drive is letter D) in DOS mode. ASUS DOS installation shell will appear and present you with a list of install option.

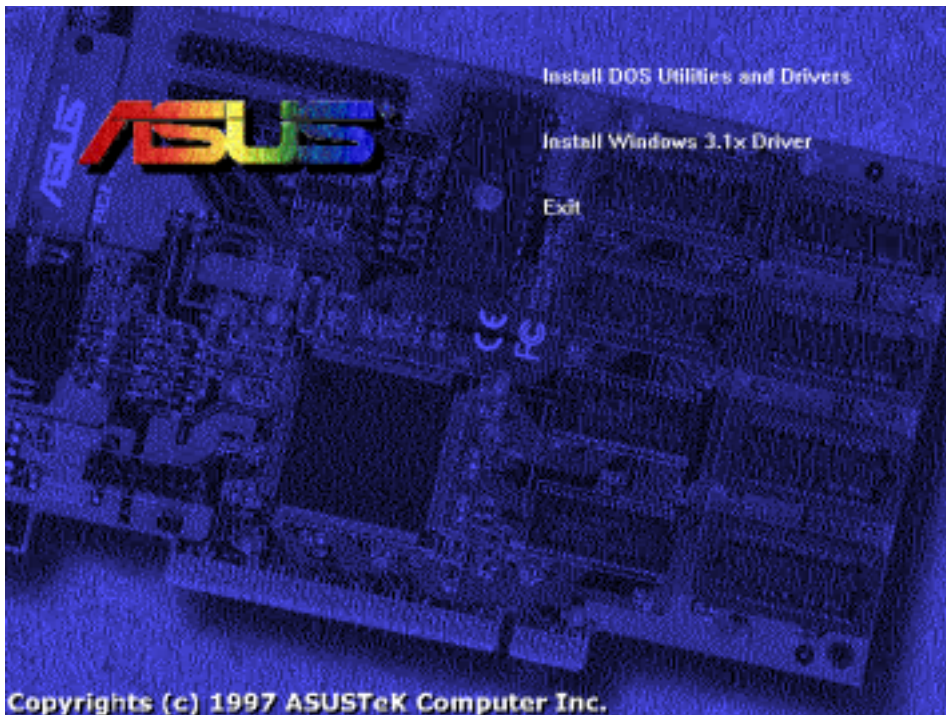

4. Press Enter to confirm path of Windows 3.x or change if necessary.
5. "ASUS driver is successfully installed !!" - **press any key**.
6. "Do you want to launch Windows 3.1 to continue installation now? (Y/N)
Note: You must make sure that ASUS ATI VGA card has been plugged in your machine." - Press **Y**.
7. Install Shell Message appears:

Now installation process will continue. If you want to install Video for Windows, please keep your ASUS driver CD in CD-ROM drive.

8. Click **OK** - Follow the instructions for Software MPEG & Video Player.

B. Video Driver

Software MPEG & Video Player for Windows 3.x

Software MPEG allows the viewing of the following video files identified by their extensions:

- MPEG Format: (*.MPG, *.DAT, *.MPV) Extensions
- AVI Files (*.AVI) Extensions

For Software MPEG support in Windows 3.x, you must first install Microsoft's Video for Windows, then install ATI Video Player.

Installing Microsoft Video for Windows in Windows 3.x:

1. Click on **Install Video for Windows** - Video for Windows 1.1 Runtime appears
2. Click **Continue** - Setup appears - Setup Successful appears
3. Click **Restart now** to complete installation

Installing ATI Video Player in Windows 3.x:

1. Run **File Manager**
2. Insert the ASUS installation CD.
3. Change to your CD drive.
4. Double click **setup.exe** - ASUS Windows 3.1 Install Shell appears

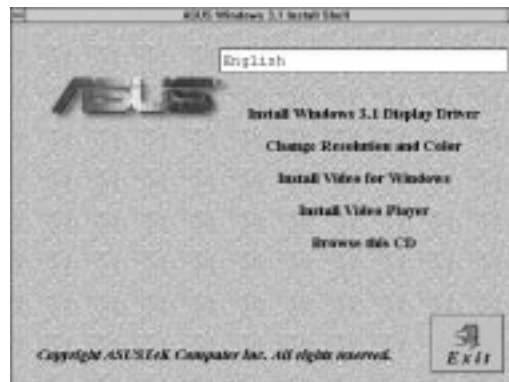

5. Click on **Install Video Player** - Memory Requirement appears:

The ATI Video Player needs at least 600K conventional memory to execute. If you are not sure or memory is not enough, you can type "**MEMMAKER**" under DOS to optimize your memory configuration.

6. Click **Continue** - ATI Setup: ATI VIDEO PLAYER appears with message
7. Click **OK** to start installation - Installation completed message appears.
8. Click **OK** to complete installation - Restart Windows? appears
9. Click **Restart Windows** button.
10. The Video Player icon will be added to the ATI Desktop menu.

(This page was intentionally left blank)

B. Video Driver

NOTE: This section shows screens for Windows 3.1x although feature descriptions may be used for both Windows 3.1x and Windows 95.

ATI Desktop Control Panel

An ATI DeskTop is installed automatically when you install the enhanced driver for Windows. Double click on the icon to display the ATI Desktop Control Panel.

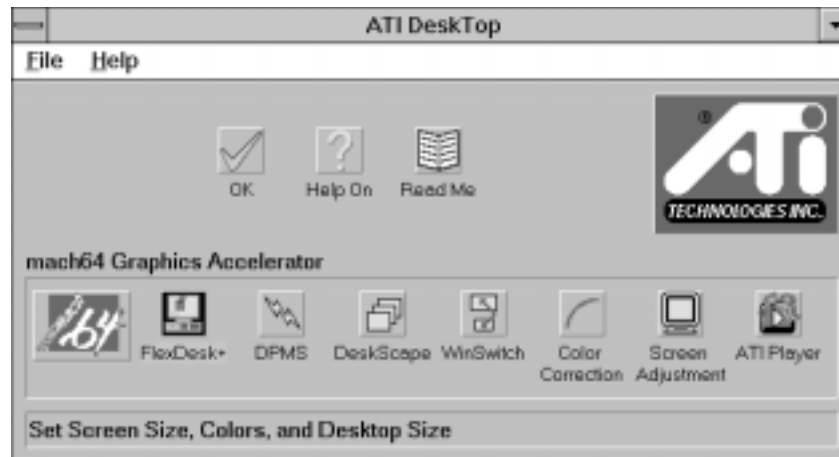

The **ATI DeskTop** provides a consistent and integrated control. Depending on what has been installed, your DeskTop may not have the same number of features as shown above.

Each feature icon in the *Mach64* product group shown in this DeskTop is described on the following pages.

ATI Desktop Features

Help On: Click this icon, then click any other icon in the product group to display Help information on the selected item.

Read Me: Click this icon then click the Mach64 logo or feature icon to display the readme file on the item.

ATI Logo: Double click this logo to generate a problem report which includes pertinent data on your system and device configuration to help solve your problem. Have the report ready before contacting your vendor.

Feature Icons: Double click a Feature icon to launch the associated control panel.

B. Video Driver

FlexDesk+



FlexDesk+ Basic Settings

FlexDesk+ is for configuring the operating modes and parameters of the ASUS 264 Series Device. The availability of options in FlexDesk+ is dependent on the device and its hardware configuration. This control panel allows you to configure Colors (color depth), Screen Size (resolution), Desktop Size (virtual desktop size), Advanced settings and Default parameters (factory settings). A Status Bar at the bottom of the panel displays help information as you make your selection.

FlexDesk+ Provides **dynamic screen information feedback** as you adjust the sliders for "Colors", "Screen Size" and "Desktop Size." Any setting not supported by the device is shown in gray. A slider will always snap to the nearest supported setting for the current slider combination.

The **Sample Color Bar** next to the Sample Monitor dynamically shows a color palette that approximates the Colors setting as you adjust the Colors slider.

NOTE: If your desired resolution is not available, check your monitor configuration setting in the INSTALL program.

Sliders

Colors: Select color depths of 256; 32, 768; 65, 536; or 16.7million colors.

Screen Size: Selects standard screen resolutions of 640x480, 800x600, 1024x768, 1152x864, and 1280x1024.

Desktop Size: Selects virtual desktop sizes of 640x480, 800x600, 1024x768, 1152x864, 1280x1024, and 1600x1200. Desktop size is greater than or equal to Screen size. The virtual desktop provides expanded work space on your screen even if your monitor cannot display that resolution by allowing you to pan past your visible screen.

B. Video Driver

Buttons

Test: Automatically switches on monitor to display the selected mode without exiting this control panel, for 10 seconds or until the user clicks the End Test, OK, or Cancel button. All other buttons and sliders are inactive at this time. To show dynamic color depth changes in this test, the WinSwitch feature must be enabled before starting the current session of Windows.

Defaults: Returns Screen Size, Colors, and Desktop Size sliders to the default positions. When OK is clicked, these changes will be effective.

Advanced...: Opens the Advanced panel. See FlexDesk+ Advanced Settings.

Help: Displays Help information on FlexDesk+.

OK: Exits the FlexDesk+ control panel and effects all new changes.

Cancel: Discards all changes and exits the FlexDesk+ control panel.

FILE Menu

Open: Opens an existing Setting file.

Save: Saves the current settings to the active Setting file.

Save As: Saves the current settings to an alternate Setting file which you can name.

Exit: Exits the FlexDesk+ control panel.

FEATURES Menu

Defaults: Provides same functionality as the push button.

Advanced...: Provides same functionality as the push button.

HELP Menu

Help: Provides same functionality as the push button.

Contents: Displays the Help index.

About...: Displays the product version number and information.

B. Video Driver

FlexDesk+ Advanced Settings

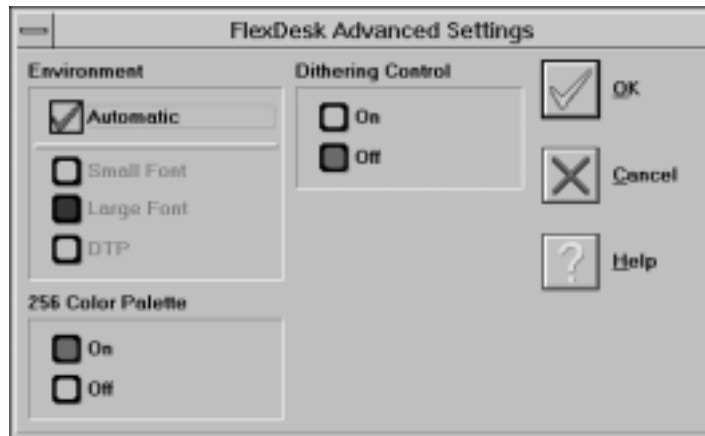

Environment

This parameter specifies logical dots per inch (LDPI). Being logical, i.e., not physical dots, the effect will differ depending on screen size. Automatic Mode chooses the optimal environment setting for the selected screen size. The Small, Large and DTP settings are 96, 120, and 128 LDPI respectively.

256 Color Palette

This selection is only available in 256 color mode. **Windows runs faster when this option is turned off.**

On: Allows the application to define color selection in the palette.

Off: Choose colors from a fixed palette.

Dithering Control

Dithering is meshing two colors to produce the illusion of a third. This selection is only available in 256 color mode with 256 Color Palette on.

On: Provides standard VGA dithering of colors and color selection boxes.

Off: Provides smooth dithering which results in faster performance than VGA dithering.

Buttons

OK: Accepts the advanced settings as shown and returns to the FlexDesk+ main panel.

Cancel: Discards all changes and returns to the FlexDesk+ main panel.

Help: Displays Help information on FlexDesk+.

B. Video Driver

DPMS (for Windows)

Win3.1 Limitation: In some newer BIOS, DPMS function doesn't work normally.

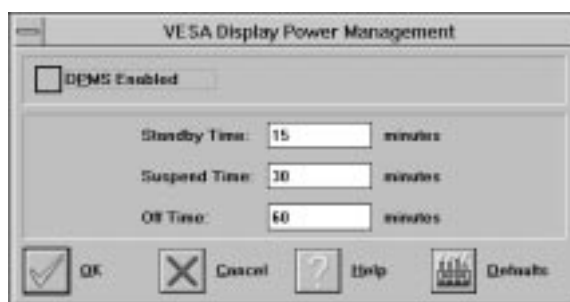

VESA DPMS-compliant monitors conserve electrical energy by powering down after a period of inactivity. You can use the DPMS panel (in Windows) to configure the auto-shutdown timing sequence for your DPMS-compliant monitor. (The DOS version of DPMS is described in another section.)

WARNING! Monitors that do not support VESA DPMS can be damaged by activation of the DPMS feature. Do not use screen saver when DPMS is enabled. The screen saver will conflict with the DPMS operation.

Enable DPMS for Windows:

1. Click the DPMS icon.
2. Highlight the timer boxes one at a time and specify the values.
3. Turn on DPMS Enabled.
4. Click OK.

Timer Settings

Standby Time: Time value is in minutes, after which Standby mode is activated if no user activity is detected. Standby is the first level of power conservation.

Suspend Time: Time value is in minutes, after which Suspend mode is activated if no user activity is detected. The monitor conserves more energy at this level than at Standby.

Off Time

Time value is in minutes, after which Off mode is activated if no service activity is detected. At this level, energy conservation is the highest.

Buttons

DPMS Enable: DPMS feature is enabled if box is checked.

Defaults: Sets DPMS timers to default values.

Help: Displays Help information on DPMS.

OK: Accepts settings as shown and exits.

Cancel: Discards all changes and exits.

B. Video Driver

DeskScape



NOTE: Press **Default** to fill in the fields with default keys first.

DeskScape allows more control over your Virtual Desktop using keyboard keys. For a description of Screen and Desktop, Refer to the *Using FlexDesk+* section.

The displayed image on the screen is a "window" showing only a portion of the entire virtual desktop. The non-displayed portion can be brought into view by panning. Four keys are assigned to this function, one for each direction of up, down, left and right. If you are using a mouse, the window may be panned by moving the mouse cursor to any edge of the window as well.

Zoom In will display a larger image but less of the desktop; Zoom Out has the opposite effect. What you can zoom is dependent on the relative settings of Screen Size and Desktop Size.

Use this panel to assign the six hot keys to Panning and Zooming functions. Alpha-numeric keys may be assigned in any combination with <ALT>, <Ctrl> and <Shift>. We recommend that you assign all the keys in one session.

DeskScape Functions

Pan Up: Moves the "window" upward, with user defined keys, e.g., Alt ↑.

Pan Left: Moves the "window" to the left, with user defined keys, e.g., Alt ←.

Pan Right: Moves the "window" to the right, with user defined keys, e.g., <Alt →.

Pan Down: Moves the "window" downward, with user defined keys, e.g., <Alt ↓.

Zoom In: Makes the screen image larger, with user defined keys, e.g., <Alt>+<Home>. **NOTE:** The entire desktop can be panned.

Zoom Out: Displays more of the virtual desktop, with user defined keys, e.g., <Alt>+<End>

B. Video Driver

Buttons

Defaults: Assigns default keys to DeskScan.

Help: Displays Help information on DeskScan.

OK: Accepts key assignments as shown and exits.

Cancel: Discards all changes and exits.

WinSwitch



NOTE: Press **Default** to fill in the fields with default keys first.

By pressing a user-defined set of keyboard keys **WinSwitch** can dynamically change screen attributes (i.e., Colors, Screen Size and Desktop Size) without exiting Windows.

When enabled, WinSwitch is actually operating in 24bpp mode-i.e., all other color depths and resolutions are emulations. As such, graphics performance across various color depths will be practically identical to that of 24bpp (16.7 million colors). Therefore, WinSwitch should be used only when color depth changes are desired. For maximum performance in 256 or 65, 536 color modes, you should disable WinSwitch. **FlexDesk+** or **DeskScan** can provide the same dynamic screen size or desktop size switching functions.

Configuring the WinSwitch Panel

At the top of the panel is a checkbox labelled WinSwitch Enabled. This switch must be turned on (checked) to enable WinSwitch, which is primarily a dynamic color switching function. Clicking one of the four radio buttons (e.g., key 1) will display the slider positions currently associated with that key.

Procedure:

1. Select a radio button. Define the key combination in the field below it. You must include <Ctrl> or <Alt>.
2. Adjust any or all of the sliders. Slider functions are identical to those in FlexDesk+.
3. Either enable WinSwitch by checking the WinSwitch Enabled box, or disable WinSwitch by removing the check mark.
4. Click Ok.

B. Video Driver

Buttons

Key 1: First of four radio buttons labeled key 1, key 2, key 3, and key 4. The slider settings shown are associated with the selected radio button.

Defaults: Restores key combination and slider settings to defaults.

Help: Displays Help information on WinSwitch.

OK: Accepts current settings and exits.

Cancel: Discards all changes and exits.

WinSwitch: Switching function is enabled when the box is Checked; disabled when the box is empty.

Key Combination Fields

Key 1 Field: Keyboard key combinations to be used to activate WinSwitch are specified in the four key combination fields, associated with Keys 1-4.

Sliders - These sliders provide the same functions as the FlexDesk+ sliders.

Colors: Selects a color depth from one of the supported Colors.

Screen Size: Sets the screen resolution to one of the supported sizes.

Desktop Size: Sets the virtual desktop to one of the supported sizes.

Screen Adjustment

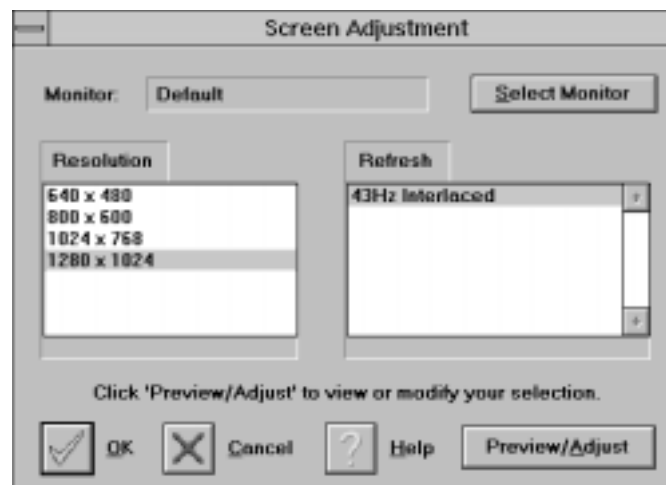

This allows the selection of different resolutions supported by your monitor. Select the proper monitor by pressing the "Select Monitor" button and then choosing from the list of monitors.

B. Video Driver

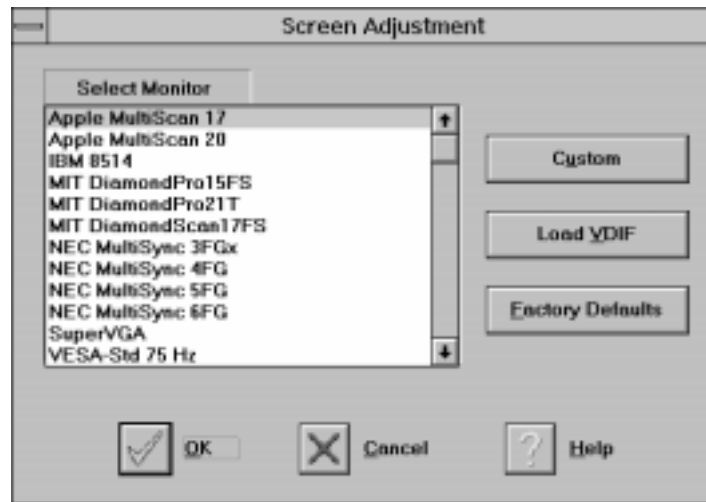

If your monitor came with a VDIF file then you may insert it into your floppy drive and press the "Load VDIF" button. The "Custom" button allows you to select the resolution and refresh rates. You may try out different settings that will optimize your display preferences but too high of a refresh rate will push your monitor past its specifications. Use the Preview/Adjust to see the results and allow digital adjustments to the screen. If the image is distorted you may press <Esc> or wait a few seconds to return to the original menu without the change.

B. Video Driver

The ASUS 264 Series Device supports a VESA power management control specification called **DPMS**-Display Power Management Signaling. Monitors that comply with DPMS can provide energy savings up to 80% compared to non DPMS compliant monitors. This also translates into extended monitor life.

DPMS control functions are provided for DOS and Windows operations. This chapter describes the DOS version, a Terminate-and-Stay-Resident program. TSR means it runs in the background once activated. The Windows version provides control via a Windows type control panel in the ATI DeskTop.

NOTES:

- Monitors that do not support VESA DPMS can be damaged by activation of the DPMS feature. Check your monitor specifications.
- Do not use screen saver when DPMS is enabled. The screen saver will conflict with DPMS operation.

DPMS (for DOS)

When you run DPMS for the first time, without parameters, DPMS will set the Standby, Suspend, and Off timers to default values. If DPMS has been loaded, running it again without parameters will display the current timer values, as follows:

Standby timer:	15 minutes
Suspend timer:	30 minutes
off timer:	60 minutes

If you run DPMS with at least one timer parameter, DPMS will set that value and disable the unspecified timers.

DPMS parameters are to be included in the command separated by spaces, as follows:

DPMS parameter <Enter>

Example: To set the Standby timer to 5 minutes, and disable the Suspend and Off timers: **DPMS STBY 5 <Enter>**

DPMS Parameters

stby x - Places the monitor into Standby mode after x minutes and seconds. For example, x for two minutes and ten seconds is specified as 2:10. Standby is the first level of power conservation. The monitor is instantly ready if activity is detected.

susp x - Places the monitor into Suspend mode after x minutes and seconds. The monitor conserves more energy at this level than at Standby.

off x - Places the monitor into Off mode after x minutes and seconds. The monitor is at the highest level of energy conservation.

nomouse - Does not detect mouse activity.

quiet - Suppresses DPMS messages.

unload - Un-installs DPMS from system memory.

help - Displays help messages.

B. Other Video Drivers

Video Driver Installation for Windows NT 4.0

IMPORTANT!

- Windows NT 3.5x does not support AGP cards.
- Before installing the ASUS display driver in Windows NT 4.0, make sure that you have installed **Windows NT 4.0 Service Pack version 3.0** (available on the Internet at http://www.microsoft.com/isapi/support/bldqpage.idc?ProductPage=q_servpk). Otherwise, the system will hang and will not be able to start up!
- For all the AGP features to be available you must be using Windows NT 5.0 (available in the future)

Windows Plug and Play in Windows NT 4.0: (Auto installing drivers)

IMPORTANT! If an ASUS Graphics device (or ATI compatible) was installed at one time, Windows NT 4.0 Plug and Play may install ATI's original driver upon entering Windows NT 4.0. The old driver may cause your system to hang. If this happens, follow these steps to reset your display driver to its basic defaults:

1. Enter Windows NT 4.0 in **safe mode** by pressing **F5** repeatedly during bootup
2. **Right click** the mouse on the open desktop (not over any icons)
3. Select **Properties**
4. Click the **Settings** tab - Settings menu appears
5. Click **Change Display Type** - Change Display Type windows appears.
6. Click **Change** button - Select Device windows appears.
7. Click **Show all devices** - Manufacturers and Models appears
8. Click **(Standard display types)** - Standard Display Adapter (VGA) is selected
9. Click **OK** button - Change Display Type windows appears.
10. Click **Apply** button - System Settings Change window appears
11. Click **Yes** button to restart your computer now - restart in normal mode

B. Other Video Drivers

Video Driver Installation for Windows NT 4.0

Installing ATI Video drivers in Windows NT 4.0: (New Hardware Found)

If installing an ASUS Graphics device for the first time, a “New Hardware Found” window will appear upon entering Windows NT 4.0:

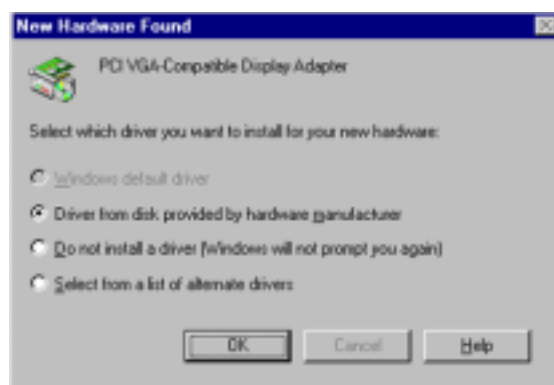

1. Click **OK** to use the default selection: “Driver from disk provided by hardware manufacturer”
2. Insert ASUS installation CD and click **Browse** button - Open windows appears.
3. Select you CD-ROM drive in the “Drives:” box
4. Select **\DRIVERS\ATI435\NT40** directory - an “.inf” file shows in ”File name:”
5. Click the **OK** button - Install from Disk appears - Click OK button again.
6. Select your device and language then click **OK** button - Copying Files... appears - message appears to restart your computer.

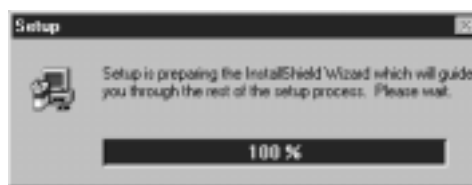

(This is only an example, your device selections may look different)

7. Click **Yes** button - ATI Desktop Help will appear upon restart, make changes as necessary.

B. Other Video Drivers

Video Driver Installation for Windows NT 4.0

Installing ATI Video drivers in Windows NT 4.0 (Prompted by Windows NT)

If an ASUS Graphics device (or compatible) was installed at one time a “Display” message will appear upon entering Windows NT 4.0 :

There is a problem with your display settings. The adapter type is incorrect, or the current settings do not work with your hardware.

1. Click **OK** button to continue - The “Settings” tab of the Display Properties appears.
2. Click **Display Type** - Change Display Type windows appears.
3. Click **Change** button - Select Device windows appears.
4. Click **Have Disk** button - “Install From Disk” window appears
5. Insert ASUS installation CD and Click **Browse** button - Open window appears
6. Select your **CD-ROM** drive in the “Drives:” box
7. Select **\DRIVERS\ATI435\NT40** directory - an “.inf” file shows in “File name:”
8. Click the **OK** button - Install from Disk appears - Click **OK** button again.
9. Select the appropriate model of your Graphics device - message appears: “You are about to install a third-party driver...”
10. Click **Yes** - Copying Files... appears - message appears: “The drivers were successfully installed”
11. Click **OK** button
12. Change your monitor type if necessary - Click **Close** button when finished.
13. Adjust the “Desktop area,” “Color palette,” and “Font size” if necessary - Click **Apply** button when finished - System Settings Change windows appears:

You must restart your computer before the new settings will take effect. Do you want to restart your computer now?

14. Click **Yes** button - ATI Desktop Help will appear upon restart, make changes as necessary.

Updating installation in Windows NT 4.0: (Using Autorun Screen)

If for some reason you need to reinstall the ATI video drivers or if you skipped the previous procedures, you may use the following steps:

1. Insert the ASUS installation CD (or double click on the CD drive in “My Computer” if CD already inserted)- ASUS Windows NT Install Shell appears.
2. Click **Install Windows NT Display Driver** - Display Properties and installation information appears.
3. Select the **Settings** tab and Continue from step 2 above.

(This page was intentionally left blank)



B. Other Video Drivers

Video Driver Installation for IBM OS/2

The ATI OS/2 video driver is to be used for the English version of OS/2 only.

Installing ATI video drivers in English OS/2 or OS/2 Warp:

1. Start OS/2
2. Check that OS/2 is using standard VGA driver and other applications are closed.
3. Double-click the **OS/2 System** folder.
4. Double-click the **Command Prompts** folder.
5. Double-click the **OS/2 Full Screen** object.
6. Insert the installation CD (assuming your CD-ROM drive is letter D)
7. Run **OS2INST** from **\DRIVERS\ATI435\OS2** <Enter>

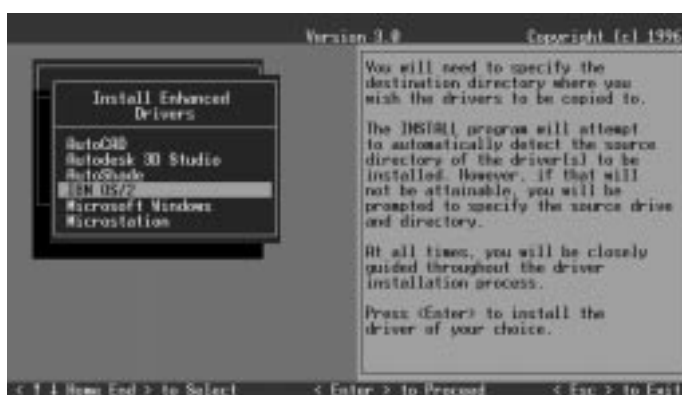

8. Select **IBM OS/2** - Install OS/2 Driver appears.
9. Select your version of OS/2.
10. Type **C:** (the drive letter of your OS/2 system) <Enter> - copying files appears.
11. Exit the installation program
12. Type **C:** <Enter>, **CD\MACH_OS2** <Enter>, **DSPINSTL**
13. Display Driver Install panel appears - select Primary Display.
14. Click **OK** - Driver selection list appears.
15. Select the latest ATI mach64 enhanced driver version from the list - click **OK**.
16. In the Monitor Configuration Selection Utility, select **Install Using Defaults for Monitor Type**, then click **OK**.
17. When the source directory panel appears, choose **Change** and enter path or use the default location of **C:\MACH_OS2** - Click **SET**
18. Click **INSTALL**.
19. Type **EXIT** to close the OS/2 full screen command prompt.
20. **Shut down** OS/2
21. **Restart** OS/2. It will default to 640x480 in 256 colors. To change screen resolution and/or color depth, see your OS/2 User's Guide.

B. Other Video Drivers

AutoCAD Video Driver Installation

Installing ATI AutoCAD Video Drivers:

1. Enter DOS mode (Exit Windows, do not use Windows DOS prompt)
2. Insert the installation CD (assuming your CD-ROM drive is letter D)

3. Type **SETUP** at the CD-ROM drive letter and the ASUS DOS installation shell will appear and present you with a list of install options. Select Install DOS Utilities and Drivers.



4. Select **Drivers Installation** and press <Enter>
5. Select the Application name **AutoCAD** <Enter>

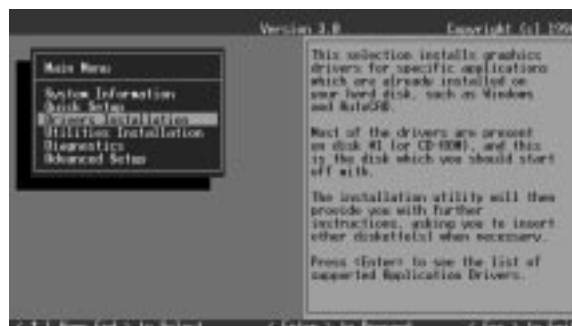

6. Follow the instructions to complete the installation of the drivers.
7. Press **Enter** when completed and press **ESC** twice and **Y** to exit the installation program.

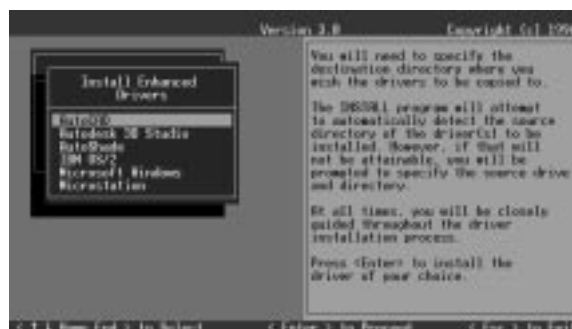

8. Reboot the computer from DOS - Your Windows 3.x & DOS system ATI drivers should be installed and ready to use.

B. Other Video Drivers

Microstation Video Driver Installation

Installing ATI Microstation Video Drivers:

1. Enter DOS mode (Exit Windows, do not use Windows DOS prompt)
2. Insert the CD (assuming your CD-ROM drive is letter D)

3. Type **SETUP** at the CD-ROM drive letter and the ASUS DOS installation shell will appear and present you with a list of install options. Select Install DOS Utilities and Drivers.



4. Select **Drivers Installation** and press <Enter>
5. Select the Application name **Microstation** <Enter>



6. Follow the instructions to complete the installation of the drivers.
7. Press **Enter** when completed and press **ESC** twice and **Y** to exit the installation program.



8. Reboot the computer from DOS - Your Windows 3.x & DOS system ATI drivers should be installed and ready to use.

B. Other Video Drivers

Select System Information (optional)

The program will check the system for possible conflicts with the device, and display both the device and system configurations in the INFO BOX. In case of a conflict, it will issue a warning and suggest possible corrective actions.

Your ASUS AGP-V264GT3 Device is PCI Plug-and-Play compatible: your system will automatically allocate system resources and resolve possible conflicts between your Plug-and-Play compatible mach64 accelerator device and other expansion cards.

System Information



Quick Setup (optional)

Select Quick Setup to configure the accelerator device to work with your monitor. As you highlight each monitor, the display specifications for that monitor type are listed in the INFO BOX. Proper monitor selection is necessary for correct resolution and refresh rate operation. You have four options to choose a correct Monitor Type.

Selecting Your Monitor Type: Factory Default/Apple.../IBM.../MIT.../NEC.../VESA-Std.../Generic.../Read VDIF.../Custom...

Select Read VDIF... If you have a VDIF file for your monitor and wish to use its parameters to automatically configure the mach64. Additional VDIF details are provided later in this chapter, in the section: *VDIF Files*

Select Custom... if none of the above applies to you, or you wish to manually configure the settings. Please refer to the information provided later in this chapter in the section: **Custom Configuration**

Notes On Refresh Rates:

- A higher refresh rate reduces screen flicker, and therefore reduces eye strain. Not all refresh rates are supported at all color depths. Refer to the features section for specifications of your ASUS 264 Series Device.
- The resolution used by your software application is independent of the refresh rate. Resolution depends on the installed software driver and selected display mode.

B. Other Video Drivers

VDIF Files (optional)

VDIF files are VESA Display Information Format files. They contain all the necessary configuration parameters for getting optimal resolution and refresh rate operation from the specified monitor. Consult your monitor manufacturer for availability of VDIF files.

If you have a VDIF file for your monitor, select it. The INSTALL program will read the VDIF file and automatically configure the device to properly work with your monitor.

Procedure:

1. Start the INSTALL program.
2. Select Quick Setup and press <Enter>.
3. Insert into a floppy drive the disk containing the VDIF file.
4. Select READ VDIF... and press <Enter>.
5. Type in the location of the VDIF file (typically A: or B:). INSTALL will read the file and configure the device to support your monitor according to the VDIF specification.

Custom Configuration

If your monitor is not listed in the Monitor Selection Menu, or you are not using DDC or VDIF, you can set up display modes, i.e., resolutions and refresh rates, on the device using the Custom... option. This option is useful even if you had selected a monitor from the list. For example, you can modify the screen centering or refresh rate on one resolution, and not change the other resolutions.

Procedure:

1. Start the INSTALL program.
2. Select Quick Setup and press <Enter>.
3. Select Custom... and press <Enter>.
4. Pick a resolution, then a refresh rate. You will see a box outline.

WARNING: Using the wrong refresh rate may permanently damage your monitor. For more information, please refer to the manual.

NOTE: An incorrect Monitor Type setting may damage your monitor. Review your monitor specifications before making a selection from the Monitor Selection Menu. Do not exceed the monitor specifications. Using a refresh rate (i.e., vertical frequency) that is higher than specified may damage your monitor. The manufacturer will not be liable for any damage caused by incorrect settings. Consult your monitor manual to determine the highest refresh rate for each resolution that your monitor supports. A scrambled screen indicates your monitor is not capable of the selected display mode. In which case, you should immediately press <Esc> to exit.

TIP: If the monitor produces a scrambled display, try a lower refresh rate. If it is already at the lowest refresh rate, set that resolution to Not Supported.”

5. Adjust the size and position of the box outline. Press <Enter> to accept.
6. Repeat steps 2 and 3 until you are satisfied with the box outline for all the resolutions. When finished, remember to exit and save the settings.

B. Other Video Drivers

Advanced Setup (optional)

If you wish to fine tune its settings for your monitor and system type, select Advanced Setup from the Main Menu. On-screen context sensitive help is displayed as you highlight each Advanced Menu item.

WARNING! The Advanced Configuration option allows you to use certain features that may add additional performance to your device. However these options may not be compatible with your system. If problems appear after an advanced option is changed, returning the device to factory defaults will rectify the situation.

Factory Defaults

The device can be reset to factory defaults by pressing <Shift>+<F7>.

Saving Your Configuration

Once you have finished configuring the necessary parameters described above, save them by pressing <F10>.

Diagnostics

All installed graphics modes in the mach64 accelerator can be viewed and tested, by running the INSTALL program from the DOS prompt, or by running a diagnostics program called M64DIAG.EXE. Do not run it in a windowed or full-screen DOS box. In the INSTALL program, select Test Graphics Adapter from the Diagnostics... option of the Main Menu. The Test Graphics Adapter menu has the following options:

- VGA Tests ...
- Accelerator Tests ...

Any time you suspect there is a problem, especially during installation, run the above tests. The information provided in this appendix will enable you to solve most problems.

B. Other Video Drivers

Troubleshooting

System Lockup

- If you are using a memory manager such as QEMM or 386MAX you need to modify the command line in the CONFIG.SYS file so that the address of the graphics device video BIOS, C000 - C7FF, is excluded. For example, add “EXCLUDE = C000 - C7FF” to the command line.
- Remove all unnecessary boards.
- Disable shadow RAM.
- Ensure that the board is seated correctly and that the device has been installed using the proper utilities.
- Try the device in a different system and reset to factory defaults using the INSTALL program. If the device works in another system, the problem is likely due to incorrect configuration.

Troubleshooting

Because a typical computer system consists of many different parts, difficulties may arise from a combination of items, from software or hardware installation, to monitor compatibility. Listed below are several checks you can make to help determine what the problem is.

Test Patterns OK; Applications Do Not Sync

The wrong monitor type has been selected. Change the settings in the INSTALL program.

Windows Driver Not Installing Properly

Windows must be running in 386 Enhanced Mode. Incompatible memory managers may prevent Windows from starting in enhanced mode. If this occurs, remove the offending driver or memory manager.

Windows NT 4.0 driver cannot pass “Test VGA.”

Please bypass “Test VGA” then load ATI drivers after completing installation.

AutoCAD Driver Not Installing Properly

If using a 386, ensure that AutoCAD has been configured for the appropriate ADI driver. The protected mode driver requires extended memory.

Error Codes and Messages

Problems and solutions for some common errors found by the test program are provided for your reference as follows:

B. Other Video Drivers

Memory aperture test failure or Diagnostics program locks or Reboots during aperture test

If you receive an error message indicating that the memory aperture location is conflicting with your system memory, restart the INSTALL program as follows: INSTALL APMAP <Enter>. Now when you enable Memory Aperture, you must select a location above but not overlapping System Memory (S), BIOS (B) or Reserved (R) locations. Not applicable for ISA cards.

Desired resolution is disabled and displayed in gray

A mode displayed in gray means that the BIOS is told this mode is not available, based on the device configuration. Reinstall using custom monitor selection.

Menu item is disabled and displayed in gray

The test program has determined that the mode or test is not available under the current configuration. Aperture tests are not available if the aperture is disabled, and CRT mode and pixel depth are determined by current installation, DAC type, memory size, and memory type.

Adapter not detected

This message should only occur when a mach64 ASIC is not detected. If this message occurs and a mach64 board is present, it may indicate an I/O conflict, conflicts between the Extended Memory Manager (EMM) and the video ROM. Try removing all other boards from the system and booting from a plain DOS disk. Try excluding the video BIOS address (C0000-C7FFF) from the memory manager. Refer to the documentation furnished with the memory manager software for information.

Any FIFO test error

The effects of a bad command FIFO should be visible. (e.g., the screen does not come up, or it displays garbage.)

Quick memory test error

Run Detailed RAM Test to confirm the error and identify the address of the error.

Detailed memory test error.

Run Detailed RAM Test several times to confirm the error and take notes of any messages and error codes.

DAC LUT test failure.

An error has occurred while testing the DAC LookUp Table. The problem should be visible on the top color bar of any 8bpp mode.

ROM checksum error.

An error has been detected in the ROM.

Draw sequence failure.

An error has occurred in the draw engine. If the error is intermittent, it might indicate a marginal RAM failure. The effects of this failure may not be immediately apparent.

B. Other Video Drivers

Windows 95 mach64 enhanced display driver

The Windows 95 mach64 enhanced display driver is capable of using monitor timing data contained within Windows 95. This data is selected by configuring a monitor type at Windows 95 installation time or via the “Settings” page of the display properties sheet.

The Windows 95 mach64 enhanced display driver may incorrectly interpret Windows 95 monitor timing data for some older monitors which require interlaced modes. This may cause some options to be disabled. A solution to this problem is to select one of the “(Standard monitor types)” available via the settings page of the display properties sheet.

If you change the selected monitor type via the “Settings” page of the display properties sheet the new timing data may not take effect until after restarting Windows 95. A solution to this problem is to always restart Windows 95 after changing the monitor type.

In Windows 95, display drivers can be installed via the “Add New Hardware” wizard. This is not recommended because when the Windows 95 mach64 enhanced display driver is installed via the “Add New Hardware” wizard the “Settings” page does not get installed into the mach64 display adapter property sheet.

Windows 95 property page problems

While adjusting monitor settings in the Adjustment page of the Display Properties sheet, your monitor could become unreadable. If this occurs, press the ESC key to return to your previous monitor settings.

ATI Video Player Notes

Why can my Video Player not execute in Windows 3.1 ?

The Video Player needs at least 600K DOS CONVENTIONAL MEMORY. You can try to close some programs to acquire more memory to use. If it still happens, return to DOS and run “MEMMAKER” in your DOS directory to modify your memory configuration. Quitting some DOS TSRs (Terminate and Stay Resident) programs also helps.

After installing Xing MPEG Player, my ATI Video Player can not play Video CD even standard MPEG files.

Xing MPEG Player and ATI Video Player can not be installed together. They conflict with each other. The previously installed player will work abnormally. You can reinstall ATI Video Player to recover it.

Why can I not use the TV output function in Windows 95?

You need to make sure that your resolution is 800x600 or under and refresh rate equal to or less than 60Hz in NTSC and 50Hz in PAL.

B. Other Video Drivers

Other Problems & Actions

My monitor is not capable of high resolution or refresh rate.

It depends on the display characteristics of your monitor. Consult your monitor documentation for the proper configuration.

After installing the driver, Windows 95 doesn't prompt me to restart and the driver still doesn't work after I restart my computer.

You may have installed similar drivers before. Try the following steps to install:

1. Right-click **My Computer** on the desktop.
2. Select **Properties**. The **System Properties** dialog box appears.
3. Click the **Device Manager** tab. Be sure that **View devices by type** is selected.
4. Double-click **Display adapters**. If **Display adapters** does not appear, jump to step 8 and continue.
5. The name of your device will be listed in the box. Double-click it.
6. The properties box of your device appears. Click the **Driver** tab.
7. Click **Change Driver...** and follow the installation steps.
8. Click **Other devices**. Your device should be listed.
9. Click the name of your device to bring up the properties box of your device. Select the **Driver** tab.
10. Click **Change Driver...** and follow the installation steps.

After installation and restarting, Windows 95 informs me that the display setting is still incorrect.

There may be a conflict between a previous and the current display drivers. This is caused by the incomplete removal of the previous display driver. Try the following steps to remove it:

1. Right-click **My Computer** on the desktop.
2. Select **Properties**. The **System Properties** dialog box appears.
3. Click the **Device Manager** tab. Be sure that **View devices by type** is selected.
4. Double-click **Display adapters**.
5. You will find two (or more) conflicting adapters.
6. Disable all previous adapters by selecting them and clicking **Remove**.
7. Close Device Manager and restart Windows 95.
8. Your display driver should work correctly this time.

C. Video Player

Windows Video Player

ATI Player and control panel (Win3.1x and Win95)

If VIDEO drivers are installed, for playing video clips, the ATI Player icon will appear in the DeskTop. Double click on this icon to bring up the Video Screen as shown here: (Detailed button definitions are shown when holding the cursor over the individual buttons for a few seconds.)

The Task Control Panel

The Task control panel indicates what mode the player is in and what it's doing. (Your Task control panel may not look exactly like the illustration-only installed or available features will have controls.)

Under win31 environment



Under Win95 environment

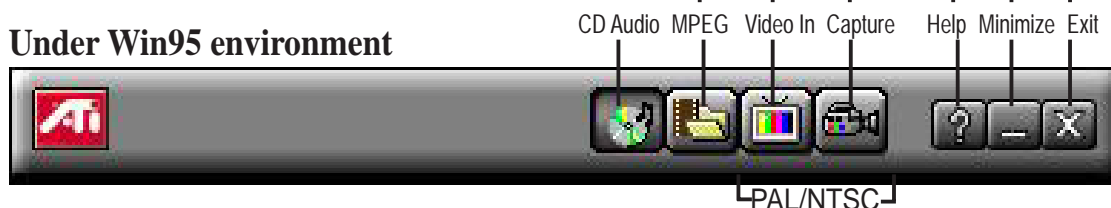

CD Audio—Play standard audio CDs (only in Windows 95)



MPEG Playback—Play MPEG and AVI video files



Video In (Tuner button)—Display live video sources (available only on video model)



Capture—Capture still images, video sequences, or audio-only (available only on video model)

Features

The question mark on top right of the Video Screen allows inspection into each button on the control panel. Click on the “?” then on a button that you would like to know about.

C. Video Player

Playing Audio CDs (Only in window 95)

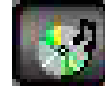

Click the Audio CD button in the Task control panel to switch to Audio CD mode

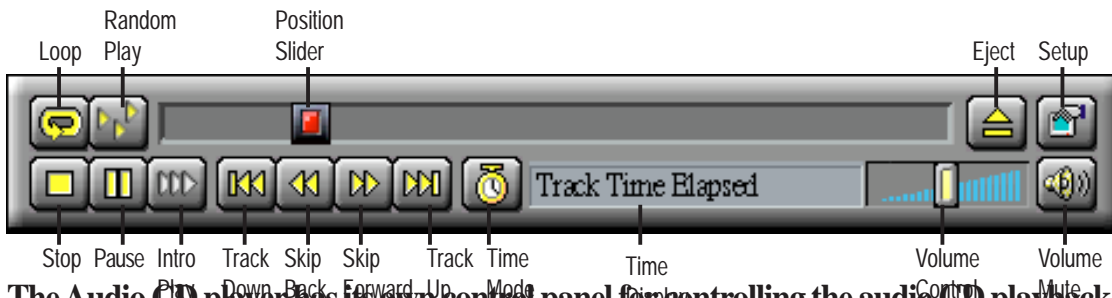



The Audio CD player has its own control panel for controlling the audio CD playback.

You can use the Audio CD panel to play standard audio CDs. Advanced features such as Random play, Intro play, which plays the first ten seconds of each track, and Loop play are available.



The Audio CD player has its own display.

To play an audio CD

1. Insert the audio CD into your CD-ROM drive.
2. In the Audio CD panel, click the Setup Dialogs button 
3. Click the Disc Info tab.
4. From the Available Tracks list, add or remove tracks as desired.
The Play List displays your current selections.
5. Click OK.
6. In the Audio CD panel, click the Play button 

The Audio CD player uses Windows 95 standard INI file to store disc names, track names, and the play list. You can use the Setup dialog to enter the name of the artist and the disc.

C. Video Player

Playing Media Files



Click the MPEG Playback button in the Task control panel to switch to playback mode.



The Control panel changes to the Playback panel.

To view/hide the Playback panel in Full Screen mode, press F2.

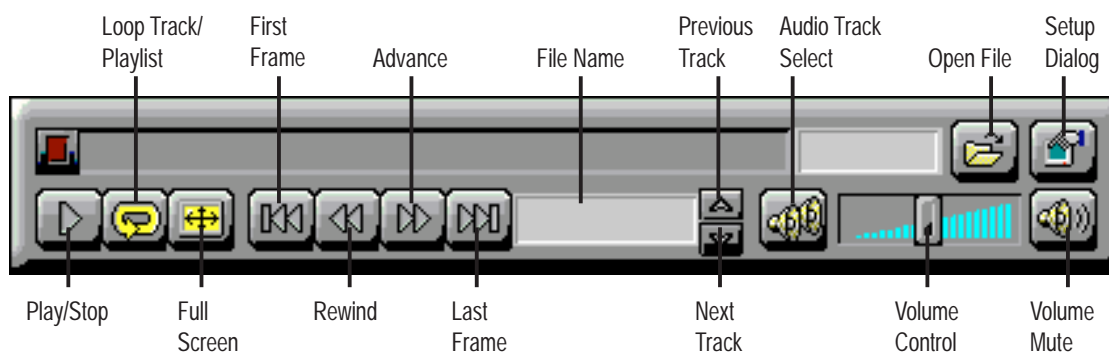

You can use the Media Playback panel to play the following media files:

- MPEG-1 digital audio and video, including Karaoke?including dual-channel audio, CDi, Games, and reference application titles
- *.AVI video files

To play a file

1. In the Playback panel, click the File Open button
2. Select a file from the list.
3. Click Add, then click OK.
4. Click the Play button
5. The file plays in the Display panel.

Playing Interactive Discs (Video CD 2.0)

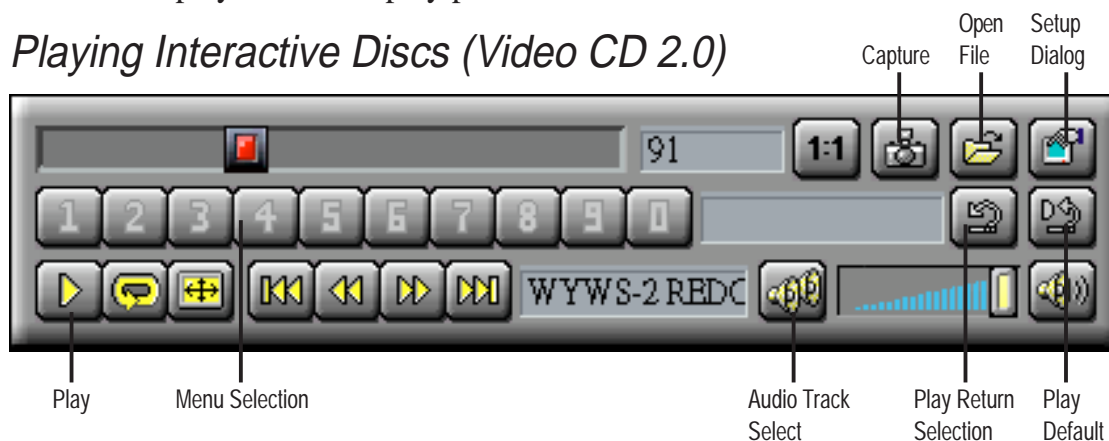

When playing Video CD 2.0 discs, the Control panel changes to this interactive panel.

C. Video Player
Windows 95/3.x

(This page was intentionally left blank)

D. Audio Driver

D. Onboard Audio	103
First Time Installation	103
Setup Audio Driver	104
Upgrade or Uninstall Drivers	104
DOS Game Support.....	105
Install ESS AudioRack.....	106
Install Microsoft DirectX5	107
E. Audio Software	109
Audio Rack Introduction	109
The Command Center	110
Introduction	110
The Command Center Controls	110
The Command Center Display	110
The Miniature Mode	111
Introduction	111
The Miniature Mode Controls	111
The Audio Mixer	112
Introduction	112
The Audio Mixer Controls	112
The Digital Audio Player	113
Introduction	113
The Digital Audio Player Controls	113
The MIDI Player	114
Introduction	114
The MIDI Player Controls	114
The MIDI Player Display	114
The Compact Disk Player	115
Introduction	115
The Compact Disk Player Controls	115
The Audio Recorder	116
Introduction	116
The Audio Recorder Controls	116
The Audio Recorder Display	116
Release Notes	117
Disable Eject Button on the CD Player	117
Using AudioRack CD Player as Default CD Player	117
Configuring Playback Mixer	117

(This page was intentionally left blank)

D. Audio Driver

First Time Installation

When starting Windows 95 (OSR2.0) or Windows NT 4.0, the operating system will detect that you have a new PCI Multimedia Device, then an **Update Device Driver Wizard** will appear.

Click **Next**.



Click **Other Locations** to direct the wizard to the audio driver files.



Click **Browse** to locate the “\DRIVERS\M2REV1.00\WIN95” (or NT40) directory on the ASUS Support CD.

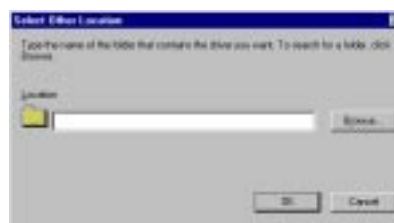

Click **Ok** and “ESS Device Manager” will be shown. Click the **Finish** button.



You will be prompted to locate the drivers again. Click **Ok**.



Click **Browse** and locate the “\DRIVERS\M2REV1.00\WIN95” (or NT40) directory on the ASUS Support CD again.

Follow the self-explanatory instructions to finish your driver installation.

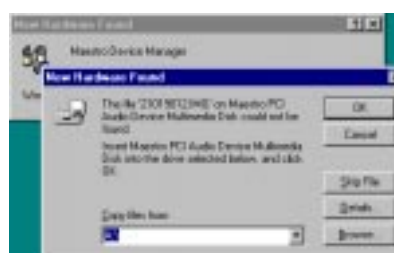

D. Audio Driver

Setup Audio Driver

Setup Audio Driver is used for upgrading, removing audio drivers, or change the “DOS Game Support Level.”

Reinsert your CD or double click on your CD drive icon in My Computer to bring up the autorun screen or run Setup.exe in the root directory of the CD. Click 95 Audio Driver from the main menu.

Click **Setup Audio Driver** to begin the installation wizard.

The “AudioDriver Setup” screen will appear.

Click **Next** and the “Choose Procedure” screen will appear. See next page to complete your installation.



Upgrade or Uninstall Drivers

Select **Upgrade drivers** or **Uninstall drivers** if you want to upgrade or remove the current drivers.

Follow the self-explanatory instructions to finish your driver upgrade/uninstallation.



D. Audio Driver

DOS Game Support

DOS support allows DOS applications to utilize the audio card in DOS mode. The game support level is set to “DOS Box and Native DOS” by default, you can change the setting by the following steps.

NOTE: The onboard audio may not work properly for DOS applications that do not have Sound Blaster support.

Select **Game support** for setup DOS game support, and “Game Support Selection” screen will appear.



Select **DOS Box and Native DOS support** if you want to use DOS applications in both DOS Box and Native DOS (to use applications in DOS without entering Windows).



Otherwise, you can select “DOS Box support only” or “NO DOS support”.

You will be prompted to restart your computer. Click **Finish** to restart.

You can obtain information on your audio card in DOS mode (not in Windows DOS box) by typing `c:\MAESTRO` (The value shown may be different for your system. The information shown may be required by DOS audio applications. Choose Sound Blaster Pro or Sound Blaster in DOS applications if prompted.)



After setup, two files (AECU.SYS and MAESTRO.COM) should have been copied into the root directory. There should also be two lines added to the AUTOEXEC.BAT and CONFIG.SYS as follows:

```
[AUTOEXEC.BAT]
c:\maestro.com
```

```
[CONFIG.SYS]
device=c:\aecu.sys
```

D. Audio Driver

Install ESS AudioRack

AudioRack provides an interface to control all of the audio functions.

Reinsert your CD or double click on your CD drive icon in My Computer to bring up the autorun screen or run Setup.exe in the root directory of the CD. Click 95 Audio Driver from the main menu.

Click **Install AudioRack** to begin the installation wizard.

After reading the information, click **Next>** to continue.

Browse to a new install directory or click **Next>** to continue.

Windows comes with a very basic CD player, click **Yes** to use ESS' advanced CD player as the default.

Click **Yes** to view other notes about ESS AudioRack.

This tells you that a shortcut was created in the programs folder of the **Start** button.

This shortcut can be used but must be accessed through the **Start** button once the folder is closed.

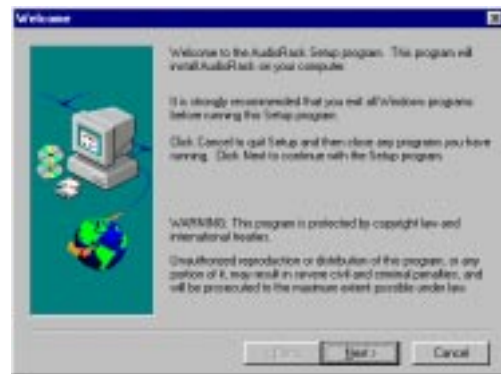

D. Audio Driver

Install Microsoft DirectX5

Microsoft DirectX5 allows DirectSound support in Windows.

Reinsert your CD or double click on your CD drive icon in My Computer to bring up the autorun screen or run Setup.exe in the root directory of the CD. Click 95 Audio Driver from the main menu.

Click **Install Microsoft DirectX5** to begin the installation wizard.

DirectX5 Setup Screen Appears

Check **Direct 3D Hardware Acceleration Enabled** option if your VGA card supports it, otherwise leave it unchecked and then click the **Reinstall DirectX** button.

Your VGA card will also be checked for DirectX5 compliance. If your existing VGA driver is older, you will be prompted to update it. Click **Yes** unless you do not want to update it.

If your system already has DirectX5 installed, the screen will show “Certified” next to each component.

You may click **Ok** to continue or **Cancel** to cancel the installation.

After reinstalling DirectX, you will be prompted to restart your machine. Click **Ok**.

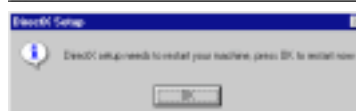

D. Audio Driver
DirectX Install

(This page was intentionally left blank)

E. Audio Software

Audio Rack Introduction

The **AudioRack32** enables you to take advantage of your computer's audio capabilities with all of the controls conveniently in one compact space. You can play audio CDs, wave files (in WAV and .AUD formats), and MIDI files (in .MID and .RMI formats). With the multisource Audio Mixer, you can blend these sources with line-in and microphone sources any way you choose. You can then record your creations as wave files and edit them with the Audio Recorder.

The **AudioRack32** has six main parts:

- Command Center—customizes the appearance of the **AudioRack32**.
- Audio Mixer—controls the volume and balance of the **AudioRack32** devices.
- Digital Audio Player—plays and records files in the .WAV format.
- MIDI Player—enables you to play MIDI files.
- Compact Disk Player—enables you to play audio CDs on a CD-ROM drive.

In addition, the **AudioRack32** has a miniature mode enabling you to control the **AudioRack32** while using minimal screen space.

The Audio Recorder is a separate application from the **AudioRack32**. It can be used to add effects and edit files recorded with the Digital Audio Player or by the Audio Recorder itself. The Audio Recorder can be launched from the **AudioRack32**'s Digital Audio Player or on its own.



E. Audio Software



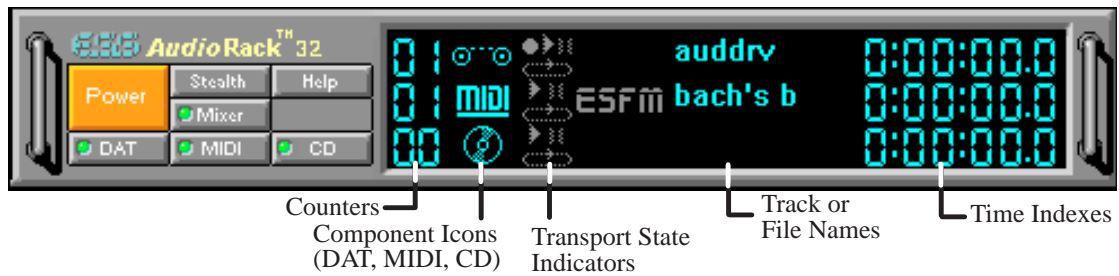



The Command Center



Introduction

The Command Center controls which parts of the *AudioRack32* are displayed. You can display or hide any part of the *AudioRack32* you choose, customizing its appearance to suit your needs or desires. It also displays information on the status of the different audio components.

The Command Center Controls

-  closes the *AudioRack32* window.
-  enables the Miniature mode, minimizing the *AudioRack32* display.
-  displays or hides the Digital Audio Player.
-  accesses On-line Help.
-  displays or hides the Compact Disk Player.
-  displays or hides the Audio Mixer.
-  displays or hides the MIDI Player.

The Command Center Display

Counter: shows you which track or file in the playlist the component is playing.

Component Icon: is displayed when the associated component is shown and is not displayed when the component is hidden.

Transport State Indicator: shows the state of a component. It indicates when the component is playing, paused, has the Auto Repeat enabled, or in the case of the Digital Audio Player, is recording.

Track or File Name: shows the name of the current track or file in the playlist.

Time Index: displays the amount of time elapsed for the track or file in hours, minutes, seconds, and tenths of a second.

E. Audio Software





The Miniature Mode



Introduction

The Miniature mode is designed to give you full control of the *AudioRack32* while using a minimum of space. You are able to effectively use the *AudioRack32* and still have enough room on your desktop to run other applications. In the Miniature mode, you can play, pause, stop, and control the master volume of the *AudioRack32*.

The Miniature Mode Controls

-  stops currently playing tracks or files of active components.
-  plays currently loaded tracks or files of active components.
-  pauses currently playing tracks or files of active components.
-  calls a popup menu where you can restore the *AudioRack32*, invoke the **Always on Top** command, select active components (DAT, MIDI, or CD), or exit the *AudioRack32*. The Stop, Pause, and Play buttons affect components that are currently active.



 controls the master volume.

E. Audio Software

The Audio Mixer



Introduction

The Audio Mixer has two modes: Playback mode and Record mode. You can use these two modes to fully control which of your audio sources you are listening to or recording, how loud each of those sources are and how they are balanced. Each audio source has its own module with mute, balance and volume controls.

In addition, the Audio Mixer provides special effects controls for chorus, reverb, treble, bass, and 3-D effects.

The Audio Mixer Controls

The two Playback and Record toggle buttons are used to switch between Playback mode and Record mode.

The Effects toggle button switches the display to the effects panel where you can use the buttons to enable and disable effects and the sliders to control the amount of the effect.

There are a number of audio source modules displayed on the Audio Mixer. The exact number displayed depends on the capabilities of your hardware. Each module has three controls:



a slider to adjust the balance

a slider to adjust the volume

a button for muting

Modules that your hardware may provide for are: Master, Line, Wave, Mic, CD, MIDI, and AuxB.

E. Audio Software















The Digital Audio Player



Introduction

The Digital Audio Player enables you to play, record, and compress sound as .WAV files. In addition, you can play .AUD files. The .WAV files use PCM, which is the Windows' audio file format. The .AUD format uses ESPCM' compression to produce an audio file. Files are written directly to your hard disk as you record, enabling you to record very large files. Your only limitation is the amount of free space on your hard disk. The voice activation feature is useful for recording any kind of intermittent audio. The Digital Audio Player provides a choice of linear PCM (8 or 16 bit) recording. Note that you have additional options using the Audio Recorder, which is invoked by the **Edit** button.

The Digital Audio Player Controls

-  starts recording to your hard disk.
-  goes to the end of the wave file or to the next file in the current playlist.
-  plays the wave file currently loaded.
-  enables or disables the Auto Repeat.
-  activates or deactivates the Pause
-  opens the Audio Recorder window.
-  stops the file currently playing.
-  opens the Set Playlist dialog box.
-  goes back one second in the wave file.
-  starts a new file by opening the New Options dialog box.
-  goes forward one second in the wave file.
-  brings up the Open file dialog box in order to load a file into the Digital Audio Player.
-  goes to the beginning of the wave file or to the previous file in the current playlist.
-  saves an audio file.

The Digital Audio Player Display

 The Level Meter displays the output from the left (top) and right (bottom) channels when a wave file is played.

 By clicking on the image of the tape deck, you can display information about the file currently loaded in the Digital Audio Player. The display tells you the file name, size, number of bits per sample, sample rate, and whether the file was recorded in stereo or mono. Click again to return to the image of the tape deck.



E. Audio Software









The MIDI Player



Introduction

The MIDI Player enables you to play MIDI files with the .MID or .RMI file extensions. These MIDI (Musical Instrument Digital Interface) files can be produced by sequencer programs and then played back using the MIDI Player. You can also mix MIDI files with other audio sources. Or you can compile MIDI files in a playlist and play them back in any order you choose.

The MIDI Player Controls

-  plays the MIDI file currently loaded.
-  goes back one file in the playlist.
-  activates or deactivates the Pause
-  goes forward one file in the playlist.
-  stops the file currently playing.
-  enables or disables the Auto Repeat.
-  goes back one second in the MIDI file.
-  opens the Set Playlist dialog box.
-  goes forward one second in the MIDI file.

The MIDI Player Display

By clicking on the image of the floppy drive, you can display the length and name of the current MIDI file in the playlist. Click the display to return to the image of the floppy drive.

 The MIDI Player has an indicator to show when you are listening to ESFM. When the ESFM light to the left of the playlist button is lit, the MIDI Player is using ESFM synthesis. ESFM performs superior-quality music synthesis compared to that of traditional FM, producing richer timbre and greater depth of instrument voices. **FM synthesis is a lower quality technology compared with Wave table synthesis. This card supports Wave table synthesis therefore ESFM is not supported on this card.**

E. Audio Software











The Compact Disk Player



Introduction

If you have a CD-ROM drive, you can play audio CDs. Check your hardware manual about setting up CD audio hardware and drivers. The Compact Disk Player uses intelligent CD playlist management: The Compact Disk Player maintains a record of each CD you play. It remembers the last playlist you used with each CD and loads that playlist automatically whenever you insert that CD.

The Compact Disk Player Controls

-  plays the MIDI file currently loaded.
-  goes back one file in the playlist.
-  activates or deactivates the Pause
-  goes forward one file in the playlist.
-  stops the file currently playing.
-  enables or disables the Auto Repeat.
-  goes back one second in the MIDI file.
-  opens the Set Playlist dialog box.
-  goes forward one second in the MIDI file.
-  ejects the CD from the CD-ROM drive.

E. Audio Software

The Audio Recorder

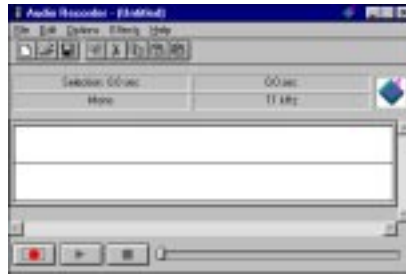













Introduction

The Audio Recorder enables you to record, compress, store, and play back voice, music, and other sound. It provides settings for sound attributes such as mono/stereo, compression level, and sampling rate. You can use it to embed sound objects in documents created in applications that support object linking and embedding (OLE).

The Audio Recorder's edit, record, and playback capabilities are compatible with the Windows Sound Recorder and other recorders that record and play back in the PCM format. Like the Digital Audio Player, the Audio Recorder can record and play back .WAV and .AUD files. The Audio Recorder allows a choice of compression from low, medium, and high ESPCM and ADPCM.

The Audio Recorder Controls

-  starts a new audio file.
-  inserts the Clipboard audio at the cursor or replaces the selected portion.
-  opens an audio file.
-  mixes the Clipboard audio with the audio beginning at the cursor.
-  saves an audio file.
-  starts recording.
-  reverses the last change you made to the current audio file.
-  plays the currently loaded audio file.
-  removes the selected portion of the audio file and stores it on the Clipboard.
-  stops the file currently playing or recording.
-  copies the selected audio portion to the Clipboard without removing it.
-  determines the cursor position on the waveform.

The Audio Recorder Display



The four text boxes under the tool bar display the length in seconds of the selected part of the currently loaded file, the total length in seconds of the current file, whether the file is in stereo or mono, and the sampling rate in kilohertz.

To the right of the text boxes is a box displaying the icon associated with the particular file. If a file has no icon associated with it, it is given a default icon.

E. Audio Software

Release Notes

This information is provided for convenience only. Information here is subject to change without prior notice. View the installation CD for any updated information in Readme text files. The AudioRack also provides detailed online help (click the **Help** button on the “Command Center”)

Disable Eject Button on the CD Player

Under the Windows directory in the file “auddrive.ini”, there is a string “DisableEjectButton=0” under the [cdplayer] section. If you would like to disable EJECT button on the CD player, you can change the value from 0 to 1. You need to close AudioRack and launch it again to make the new settings take effect.

Using AudioRack CD Player as Default CD Player

During installation, you will be asked if you want to use AudioRack CD player as the default CD player. Normally Windows 95 CD player is the default and will automatically run when an audio CD is inserted into the CD-ROM. If you answer “Yes”, the installation program will overwrite the value of the key [HKEY_CLASSES_ROOT]\AudioCD\shell\play\command in the registry. You may switch back to Windows 95 CD player by resetting this key value.

Configuring Playback Mixer

The Maestro PCI audio card offers eight inputs for the playback mixer, including “Line”, “Wave”, “CD”, “Synth”, “Aux A”, “Aux B”, “Mic”, and “Mono In”. AudioRack can only display six of them at a time. You may configure the settings by modifying the file “auddrive.ini” in the Windows directory. Under the section [MixerRak], you can enable or disable the display of each input by setting its corresponding binary value to 1(enable) or 0(disable).

(This page was intentionally left blank)

F. ASUS LAN Card

ASUS PCI-L101 Fast Ethernet Card (optional)

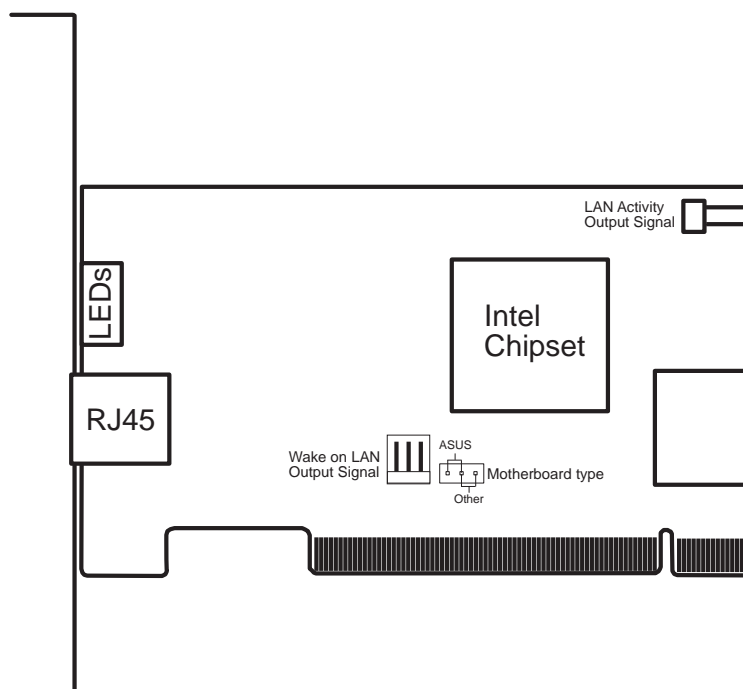
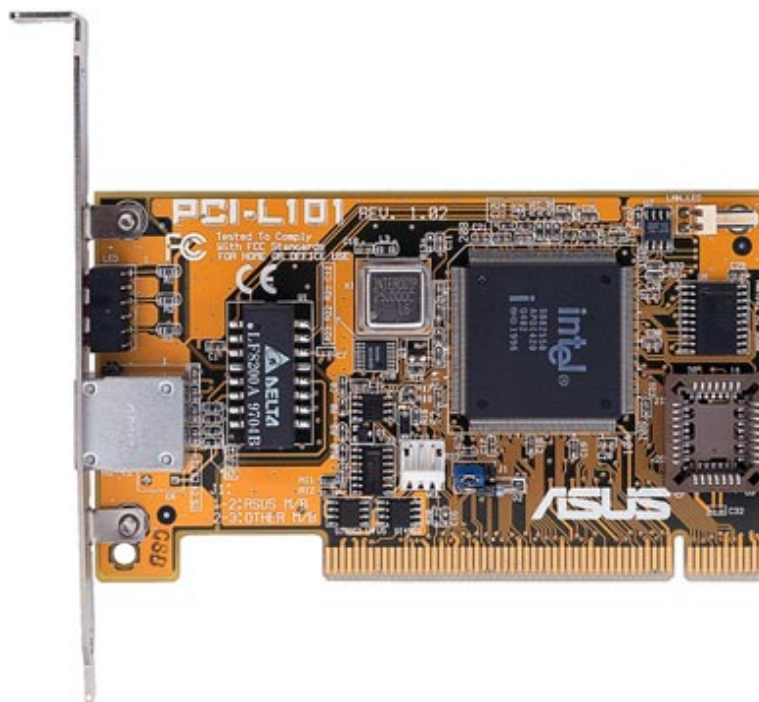

If you are using the ASUS PCI-L101 on an ASUS motherboard, leave the jumper on its default setting of “ASUS.” If you are using another brand of motherboard, set the jumper to “Other.” Connect the Wake on LAN (WOL) output signal to the motherboard’s WOL_CON in order to utilize the wake on LAN feature of the motherboard. Connect the LAN activity output signal (LAN_LED) to the system cabinet’s front panel LAN_LED in order to display the LAN data activity.

F. ASUS LAN Card

Features

- Intel 82558 Ethernet LAN Controller (Fully integrated 10BASE-T/100BASE-TX)
- Wake-On-LAN Remote Control Function Supported
- PCI Bus Master Complies to PCI Local Bus Rev. 2.1 specifications
- Consists of MAC & PHY (10/100Mbps) interfaces
- Complies to IEEE 802.3 10BASE-T and IEEE 802.3u 100BASE-TX interfaces
- Fully supports 10BASE-T & 100BASE-TX operations through a single RJ45 port
- Supports 32-bit Bus Master Technology / PCI Rev. 2.1
- Enhancements on ACPI & APM
- Adheres to PCI Bus Power Management Interface Rev. 1.0, ACPI Rev. 1.0, and Device Class Power Management Rev. 1.0
- IEEE 802.3u auto-negotiation for 10Mbps/100Mbps Network Data Transfer Rates.
- Provides LED indicators for monitoring network conditions
- Plug and Play

Software Driver Support

- **NetWare ODI Drivers** - Novell Netware 3.x, 4.x, DOS, OS/2 Client
- **NDIS 2.01 Drivers** - Microsoft LAN Manager, Microsoft Windows 3.11, IBM LAN Server
- **NDIS 3.0 Drivers** - Microsoft Windows NT, Microsoft Windows 95, Microsoft Windows 3.11

Question and Answer

Q: What is Wake-On-LAN ?

A: The Wake-On-LAN feature provides the capability to remotely power on systems supporting Wake-On-LAN by simply sending a wake-up frame. With this feature, remotely uploading/downloading data to/from systems during off-peak hours will be feasible.

Q: What can Wake-On-LAN do for you ?

A: Wake-On-LAN is a remote management tool with advantages that can reduce system management workload, provide flexibility to the system administrator's job, and then of course save you time-consuming efforts and costs.

Q: What components does Wake-On-LAN require to be enable?

A: To enable Wake-On-LAN function, your system requires Ethernet LAN adapter card that can activate Wake-On-LAN function, a client with Wake-On-LAN capability, and software such as LDCM Rev. 3.10 or up that can trigger wake-up frame.